

Ellisima^{GOLD}® & *Ellisima*®

On Screen Designer™

Instruction and Reference Guide



FOR THE LOVE OF SEWING

To receive Baby Lock product updates and offers, go to www.babylock.com/profile.
If you have questions visit your Authorized Baby Lock Retailer.

Baby Lock Consumer Helpline: 800-313-4110
www.babylock.com

Introduction

Thank you for using our embroidery design software On Screen Designer™.

On Screen Designer™ enables you to create original embroidery patterns directly from the screen of your Baby Lock household computerized sewing machine that is equipped with the compatible embroidery function. Before using this software, carefully read the instructions contained in this manual in order to fully understand each of the various functions and the correct operation of this software. Keep this Instruction and Reference Guide in a safe place for future reference.

Note:

This Instruction and Reference Guide does not contain explanations on the operation of the sewing machine. For details on using the sewing machine functions to edit embroidery patterns, refer to the Instruction and Reference Guide for the sewing machine.

Important:

Use of this software for unauthorized duplication of optional embroidery cards, newspapers or magazines, etc. for commercial purposes may be unlawful and violate copyright laws.

This application is protected by copyright laws. The use and duplication of this software is regulated by copyright laws.

This software is for household use only.

Safety Precautions

Note:

For safety precautions concerning the sewing machine, refer to the Instruction and Reference Guide provided with the sewing machine. Use the sewing machine safely and correctly, as described in the Instruction and Reference Guide.

What You Can Do With This Software

This software allows you to create original patterns just by using the touch pen (stylus) or pen tablet to draw images and text on the screen of the sewing machine or the tablet and painting the drawing with the desired colors as easily as drawing images and text on paper with a pen.

Until now, you could select various characters from those available, combine them, and then embroider the characters. However, now you can write your signature on the screen, and then embroider it. The pen tablet, included with your sewing machine or with the purchasable upgrade kit, makes this software so much easier to use.

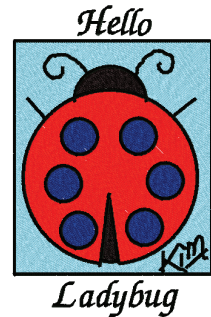

The created embroidery patterns can be resized, combined with characters and images and freely arranged in the sewing machine's embroidering or embroidery-editing screen in the same way that built-in embroidery patterns are.

If you have a favorite picture, it can easily be traced using the pen tablet. Follow the procedure described in "Tracing the Picture using the Pen Tablet" on page 41.

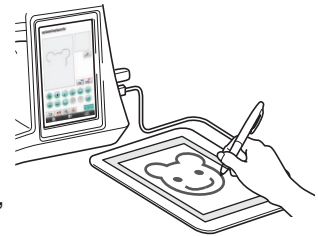

Before you write your signature or draw pictures with the pen tablet, begin with a draft drawing, then slowly and carefully trace the draft drawing. This will help create beautiful finished lines.

Embroidery patterns that can be created with this software

Lines of the drawing are sewn with satin stitches and areas are sewn with fill stitches. The following settings can be specified.

- ① Satin stitch (lines): thickness and stitch density
- ② Fill stitch (areas): sewing direction and stitch density

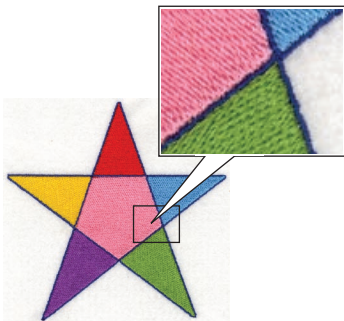

Line thickness: 1.0 mm

Fill stitch sewing direction: 

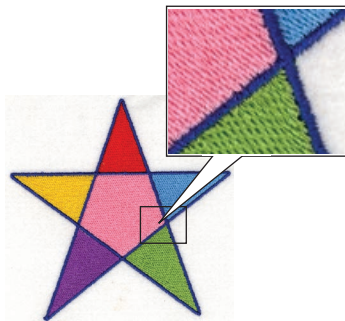

Line thickness: 3.0 mm

Fill stitch sewing direction: 

Chapter 1 Before Use

Checking

Sewing Machine

On Screen Designer™ can be used with the following sewing machines. Check that your sewing machine model and its program version meets the following requirements.

Models: BLSO/BLSOG

Program: KIT II certified

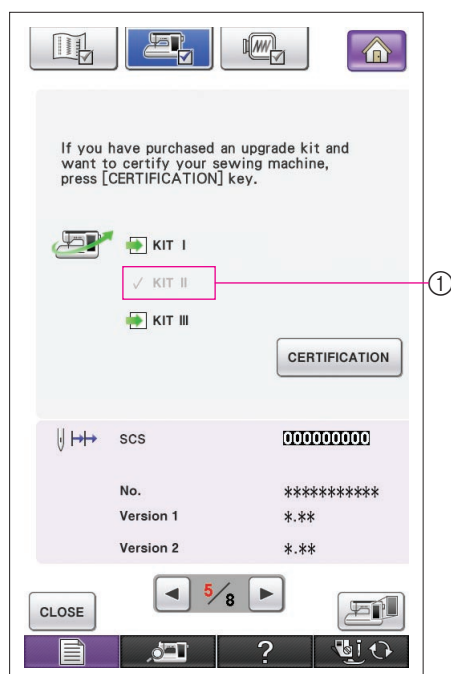

* The KIT II certification can be checked by pressing  (Settings) key. For more details, refer to the Instruction and Reference Guide provided with the sewing machine.

① KIT II certified

For upgrade information consult with your authorized Baby Lock retailer or visit our website at www.babylock.com

USB Media

Important:

Since all data saving media, including USB media, may sometimes fail, we recommend that you make backup copies for all saved data.

The sewing machine reads this software and starts it up from USB media. In addition, data created with this application is stored on the USB media. Follow the precautions below when handling the USB media.

- For details about available USB media, visit our website “ www.babylock.com ”.
- Do not insert USB media containing pattern data other than those saved using this application. (Only .pm7 and .phc data can be used.)
- If the file name of embroidery data cannot be identified, for example, the name contains special characters, the names are not displayed. If this occurs, change the name of the file.
- Do not create folders in USB media. If embroidery data is stored in a folder, that embroidery data cannot be displayed by the sewing machine.





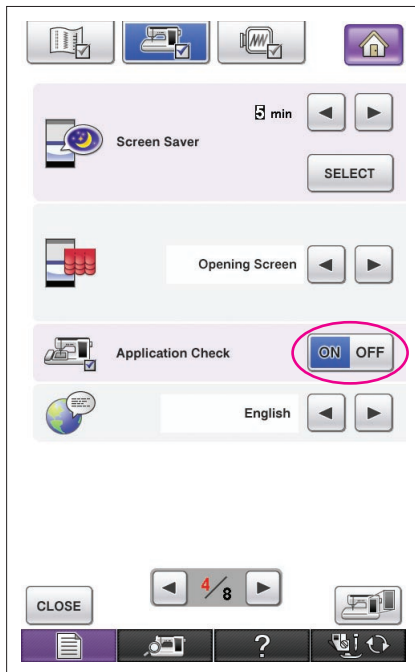

Precautions on the Use of the Display

- Only touch the screen with your finger or the pen (stylus) included with the sewing machine. Do not use a mechanical pencil, screwdriver or any other hard or sharp object. In addition, do not press the screen with extreme pressure, otherwise the screen may be damaged.
- All or part of the screen may sometimes become darker or lighter due to changes in the surrounding temperature or other changes in the environment. This is not a sign of a malfunction. If the screen is difficult to read, adjust its brightness.

Setting The Sewing Machine To Start Up The Software

The sewing machine must first be set so that On Screen Designer™ can be started up. “Application Check” on the settings screen must be set to “ON”. If the sewing machine is turned on with USB media inserted, the machine checks the software on the USB media, and then starts it up.



- 1 Turn on the sewing machine.
- 2 Press , and then press  to display page 4/8 of the settings screen.
- 3 On the  Application Check display, press  so that it changes to , and then press .
- 4 Turn off the machine.

Starting Up On Screen Designer™

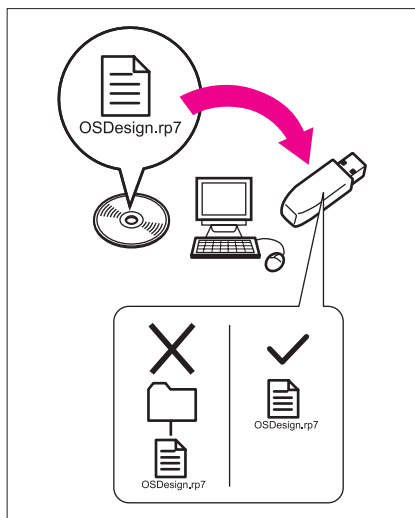

- 1 Copy the software program file on the CD to your USB media using your computer.
File name: OSDesign.rp7

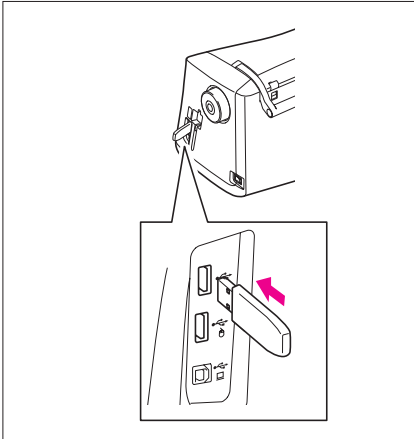

2 Insert the USB media containing the application into the primary (top) USB port on the right side of the machine.

Caution

- Do not insert anything other than USB media into the USB media port. Otherwise, the USB media drive may be damaged.
- Do not insert USB media containing pattern data other than those saved using this application. (Only .pm7 and .phc data can be used.)

3 Turn on the sewing machine.

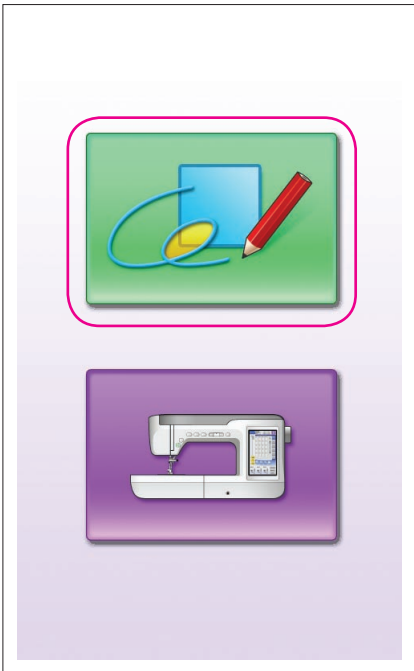

4 Press the opening screen. A screen that allows you to select the application or sewing machine, like what is shown at the left, appears.

- * If USB media that does not contain the application is inserted, the home screen appears.

5 Press the icon for the application. On Screen Designer™ starts up.

Caution

Do not turn off the machine or remove the USB media while the application is starting up, otherwise the USB media may be damaged.

Notes

- If you have turned off the sewing machine while embroidering, previously embroidered pattern will not be recalled when you turn on the machine again.

Closing the Application

1 To close On Screen Designer™, turn off the sewing machine.

To close the application to use the sewing machine, press . (Refer to page 46.)

Notes

- When the application is closed, the currently displayed data is deleted. Be sure to save any necessary data before closing the application.



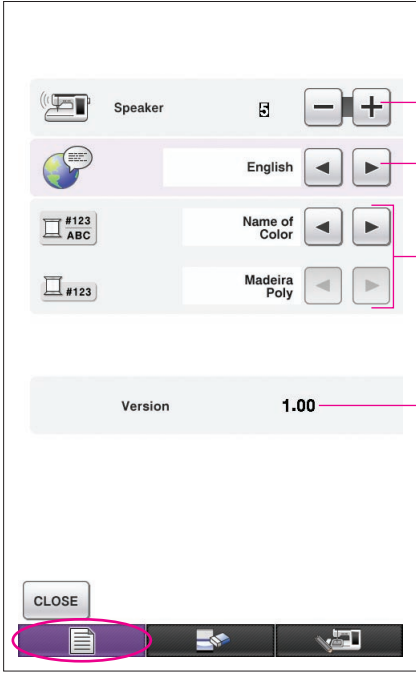



Key Operations





1 Press  to display the screen shown at the left.

Notes

- Screen illustrations may vary due to model of machine.
- You can use the pen tablet for operations in the settings screen.

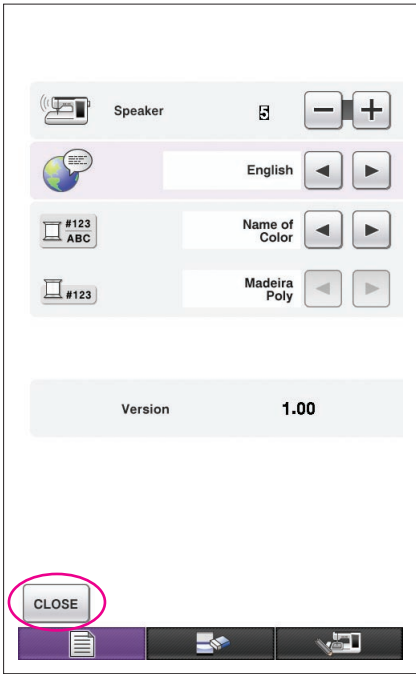
- ① Adjusts the speaker volume
Press  and  to adjust the speaker volume.
- ② Changes the display language
Use  and  to choose the display language.
- ③ Changes the thread color display (thread brands or color number)
Use  and  to choose the thread color information.
- ④ Displays the version information for On Screen Designer™



2 After the desired settings are selected, press .

Basic Procedure Overview

The basic procedure is described below. For details, refer to the indicated page.

- 1** Draw the lines of the pattern in the pattern drawing screen. (→ page 10)
- 2** Adding color to the pattern. (→ page 26)
- 3** Specifying the stitching settings. (→ page 31)
Specify the width of the satin stitches and the sewing direction of the fill stitches. (→ page 32)

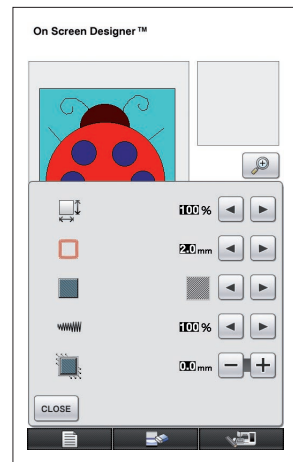
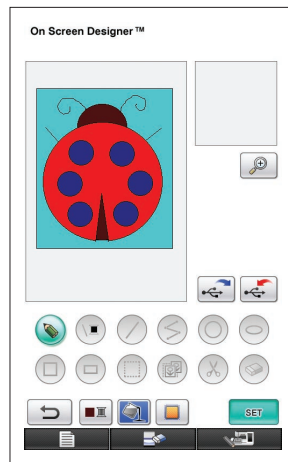
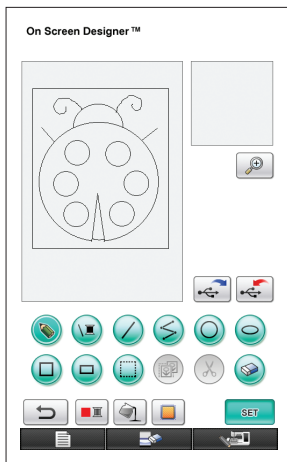

- 4** Converting the image data to embroidery data.
The embroidery data check screen appears. (→ page 35)
- 5** Saving the embroidery data on USB media. (→ page 37)

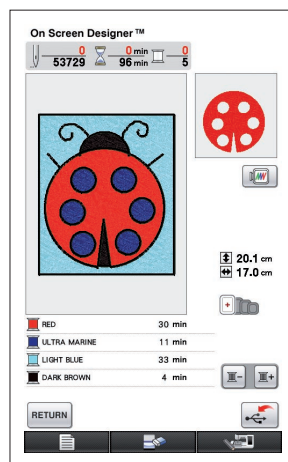
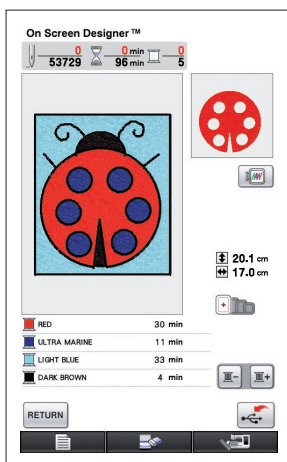

- Note**
- The actual dimension of the pattern area is the size of the extra large embroidery frame, which is 30 cm × 20 cm (approx. 12 inches × 8 inches). The pattern you drew may be bigger than you expected. Please resize the pattern after retrieving the pattern to your sewing machine.

Application Screens

Pattern Drawing Screen

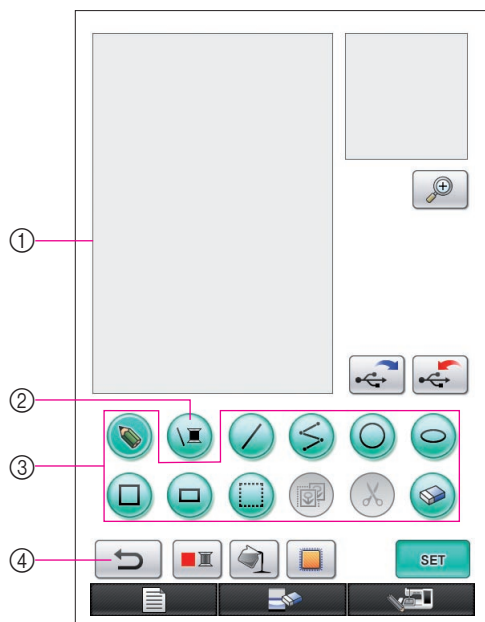

When On Screen Designer™ is started up, the following pattern drawing screen appears. The pattern can be drawn in this screen.









- ① Pattern drawing area
Draw the pattern within this area.
The actual dimension of the pattern area is the size of the extra large embroidery frame (30 cm (height) × 20 cm (width)).
Included pen tablet is activated within this pattern drawing area while drawing.
- ② Use to select the thread color of the lines.
- ③ Pattern drawing keys
Use to draw the pattern.
- ④ Touch this key to undo previous operation.

















Key displays

The appearances of the keys have the following meanings.

-  This key is selected (being used).
(When the application is started up, the freehand line key is selected.)
-  This key is not but can be selected.
-  This key cannot be selected.

■ Key functions

Key	Key Name	Description	Reference
	Machine function key	Press this key to close On Screen Designer™ and use the sewing machine. When this key is pressed, all data that had been drawn is erased.	46
	New pattern key	Press this key when you want to begin creating a new pattern. When this key is pressed, the currently displayed data is deleted and the first screen displayed when On Screen Designer™ is started up appears.	45
	Settings key	Press this key to adjust various screen settings.	8
	Freehand line key	Press this key to draw lines freehand.	21
	Line thread color key	Press this key to select the color of the lines.	26
	Straight line key	Press this key to draw straight lines.	21

Key	Key Name	Description	Reference
	Continuous straight line key	Press this key to draw straight lines that are connected.	15
	Circle key	Press this key to draw circles.	13
	Ellipse key	Press this key to draw ellipses.	16
	Square key	Press this key to draw squares.	22
	Rectangle key	Press this key to draw rectangles.	22
	Select/move key	Press this key to select a section for moving, copying or deleting lines and shapes that have been drawn.	17, 18, 19, 20
	Copy key	Press this key to copy the selected section.	20
	Delete key	Press this key to delete the selected section.	18
	Erase key	Press this key to erase lines that have been drawn.	23
	Fill key	This key will highlight when the area thread color key is pressed and thread color selected.	28
	Area thread color key	Press this key to select the color for an area to be filled.	27
	Undo key	Press this key to undo the last operation that was performed and return to the condition before that operation was performed. Each press of this key undoes one operation.	14
	Zoom key	Press this key to display an enlargement of a specified section.	24, 29
	Recall key	Press this key to recall image data from USB media.	42
	Store key	Press this key to save the image data onto USB media.	37, 41
	Stitching settings key	Press this key to specify stitching settings. Shrinkage adjustment, the width of satin stitches, the sewing direction of fill stitches and the stitch density can be specified.	31
	Convert key	Press this key to convert the image data to embroidery data.	35



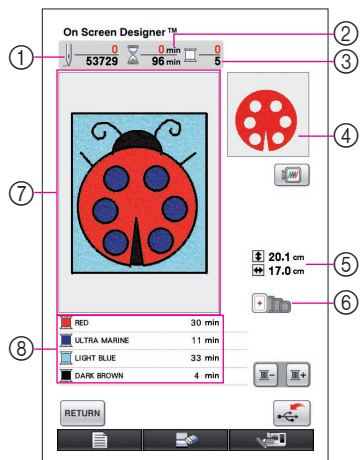

Embroidery Data Check Screen

Once you are finished drawing the pattern, press the convert key in the pattern drawing screen to convert the image data to embroidery data. When the data is converted, the embroidery data check screen appears.



- ① The total number of stitches is displayed.
- ② The necessary amount of time required to sew the pattern is displayed. (The amount of time needed to change threads is not included.)
- ③ The number of colors are displayed.
- ④ The part of the pattern that will be sewn with the thread color shown first in the thread order list below is displayed.
- ⑤ The size of the pattern is displayed.
- ⑥ The types of embroidery frames that can be used are shown. The icons for the embroidery frames that can be used appear in color.
- ⑦ Embroidery pattern display area
The actual dimension of the pattern area is the size of the extra large embroidery frame (30 cm (height) × 20 cm (width)).
The pattern moves to the center of the display area and the embroidery data is displayed.
- ⑧ The names of the thread colors and their sewing order are displayed.

■ Key functions

Key	Key Name	Description	Reference
	Store key	Press this key to save the embroidery data.	37
	Return key	Press this key to return to the pattern drawing screen. The embroidery data is changed back to image data and the pattern colors can be changed or the pattern can be edited.	35
	Next thread key	Press this key to show the part of the pattern that will be sewn with the next thread color when checking the sewing order. Each press of this key shows the next part of the pattern.	-
	Thread back key	Press this key to show the part of the pattern that will be sewn with the previous thread color when checking the sewing order. Each press of this key shows the previous part of the pattern.	-
	Image key	Press this key to view an image of the pattern as it will be sewn.	36

Chapter 2 Creating a Sample Pattern

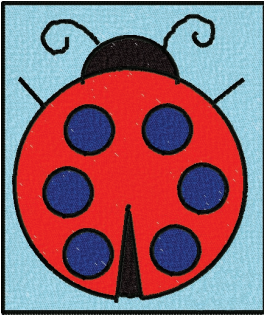

In order to get a better understanding of how to use this software, we will describe the procedure for creating the pattern shown at the left as an example. By creating an actual pattern, you can learn to master the operation of this software.

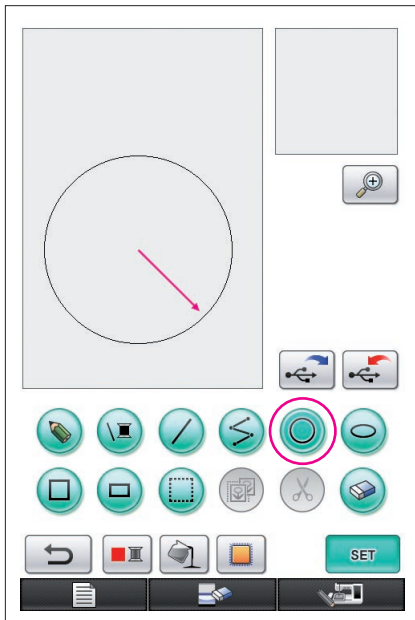
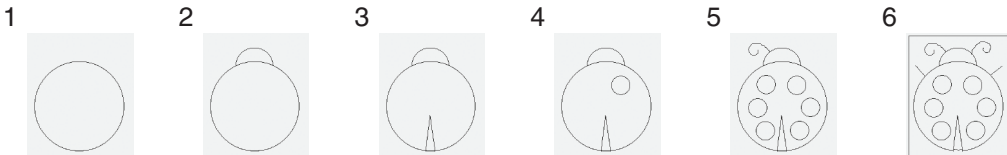

1

Drawing the Lines of the Pattern



* The arrow in the illustration shown above indicates the direction that the pen is moved.

1. Drawing a Circle

- 1 Press  so that it changes to .
- 2 From the point that will be the center of the circle, drag the pen along the screen until the circle is the desired size.
- 3 When the circle is the desired size, remove the pen from the screen.

To draw a circle

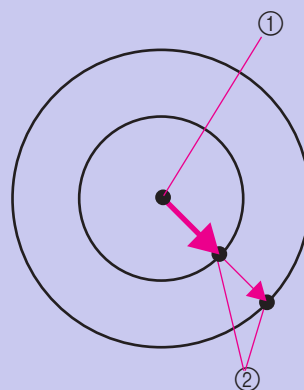

The circle is drawn with the starting point as the center and the line connecting the starting point and the ending point as the radius. The size can be adjusted as desired until the pen is removed from the screen.

- ① Starting point
- ② Ending point

■ Creating the Desired Circle

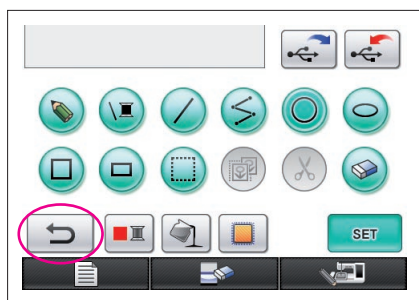

Undoing

If the position or size of the shape is not what you want, the drawn line can be erased so that it can be drawn again. There are many ways of erasing lines, but here we will explain how to use .



To undo the last drawing operation, press . The last operation that was performed is undone and the drawing reverts back to the same condition it was before that operation was performed.

Notes

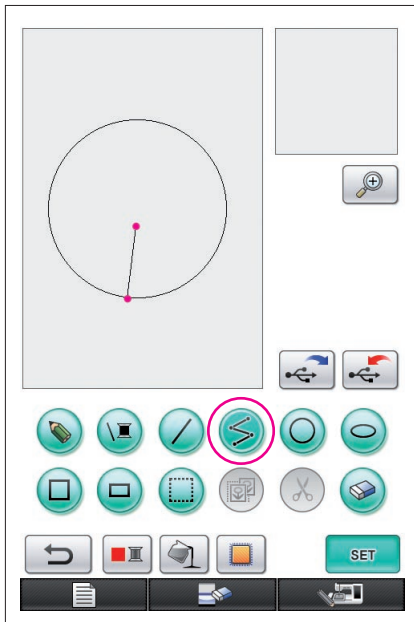
-  can be pressed at any time while the image is being drawn. For example, if a line is accidentally erased with a different operation, press this key to add back the line and return the drawing to its previous condition.
 - Each press of this key undoes one operation.
 - An undo operation cannot be undone. For example, this key cannot be pressed to add back a line that was erased by pressing this key.
-



2. Drawing Straight Lines That Are Connected

- 1 Press  so that it changes to .
- 2 Touch the point that will be the beginning of the drawing.
- 3 Touch the next point where you wish to add a corner.
A straight line is drawn connecting the starting point and the next point touched.
- 4 Touch the last point to finish drawing the line. A straight line is drawn connecting the last point to the previous point.

To draw straight lines that are connected

Each time you touch the screen with the pen, a straight line is drawn connecting the last point that was touched to the next point that is touched.

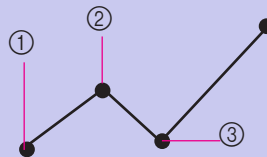

Each time the screen is touched a straight line is added to the polygon until a different key is selected.

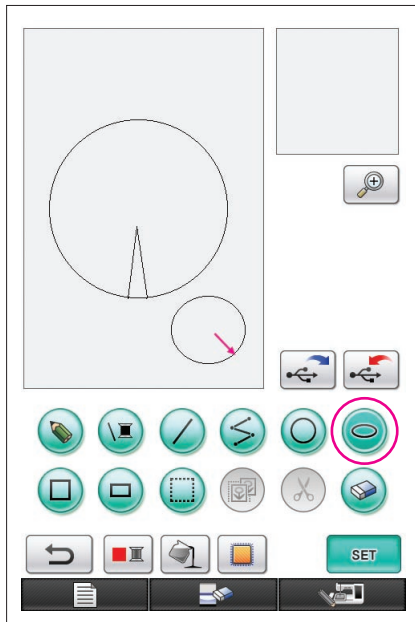

- ① Starting point
- ② Next touched point
- ③ Next touched point



3. Drawing an Ellipse

- 1 Press  so that it changes to .
- 2 From the point that will be the center of the ellipse, drag the pen along the screen until the ellipse is the desired size.
- 3 When the ellipse is the desired size, remove the pen from the screen.

To draw an ellipse

The ellipse is drawn with the starting point as the center, the horizontal length of the line connecting the starting point and ending point as the horizontal radius and the vertical length of the line connecting the starting point and ending point as the vertical radius.

The size can be adjusted as desired until the pen is removed from the screen.

* An angled ellipse, like the one shown at the right, cannot be drawn.

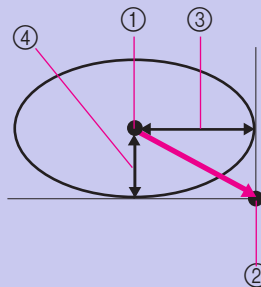

- ① Starting point
- ② Ending point
- ③ Horizontal length
- ④ Vertical length



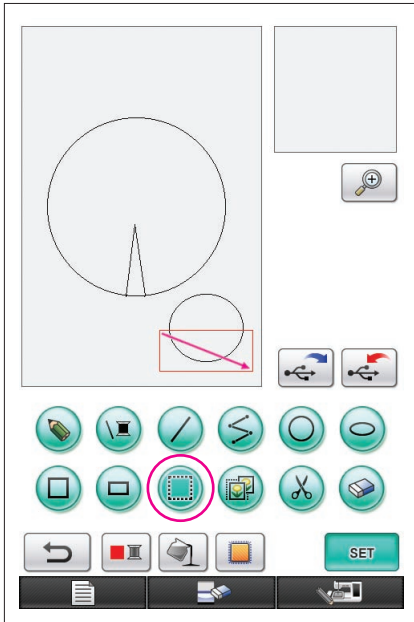



4. Selecting

For example, select the section to be deleted here.

* Before moving, copying or deleting sections, use  to select the area to be moved, copied or deleted.

- 1 Press  so that it changes to .
- 2 From the top-left corner of the section, drag the pen along the screen so that the section completely fits within the red frame (selection frame) that is drawn.
 - * The selection frame appears in red.
- 3 When the frame is the desired size, remove the pen from the screen.

Notes

- If the desired area could not be selected (the selection frame could not be drawn), try drawing it again. Touch the screen with the pen to erase the selection frame that was originally drawn, and then draw a new selection frame.
- After a selection frame is drawn, pressing any key other than the copy key or the delete key erases the selection frame.

To draw a selection frame

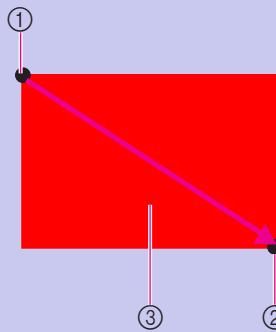

The red frame is drawn with the straight line connecting the starting point and the ending point as the diagonal. The selected area is the part within that frame.





The size can be adjusted as desired until the pen is removed from the screen.

* An angled selection frame, like the one shown at the right, cannot be drawn.



- ① Starting point
- ② Ending point
- ③ Selected area

5. Deleting Lines (Drawing a Half Ellipse)

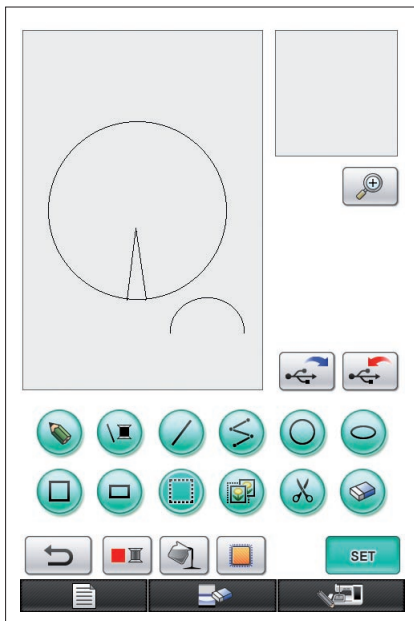
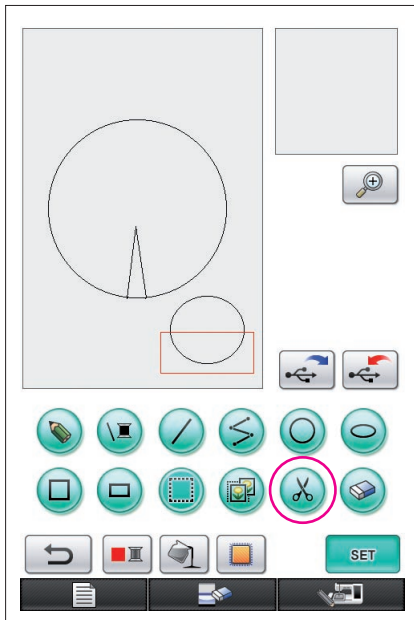

- * Here, we will explain how to delete lines using .
- * Before deleting a line using , press  so that it changes to , and then select the section to be deleted. (Refer to page 17.)
- * Lines can also be erased by selecting the  key. (Refer to page 23.)

1 Press . The lines within the selection frame are deleted.

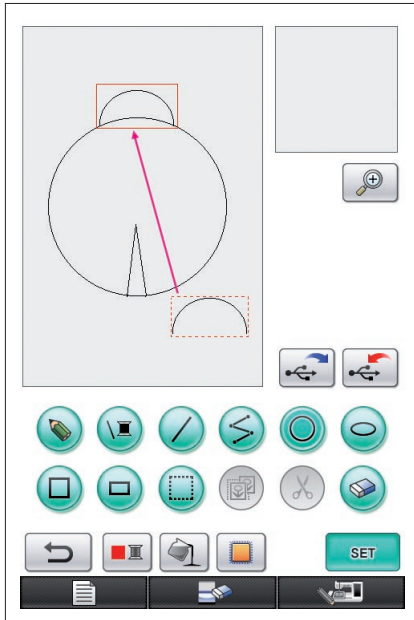



6. Moving

* Before moving, press  so that it changes to , and then select the section to be moved. (Refer to page 17.)



- 1** Follow the procedure described in “4. Selecting” to select the section to be moved.
- 2** Touch inside the red frame (selection frame) with the pen, and then drag the pen along the screen to move the selection.
- 3** When the section is moved to the desired location, remove the pen from the screen.

Notes

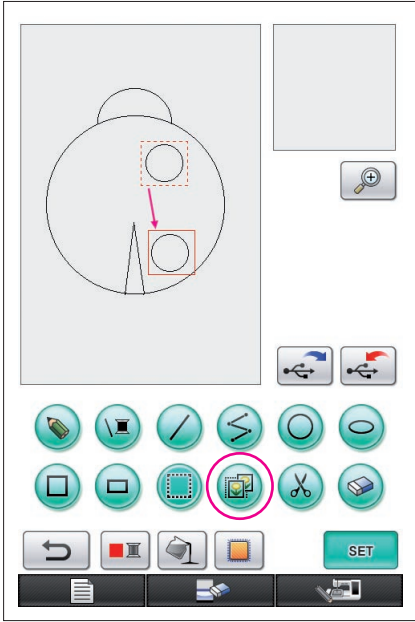
- If the section could not be moved to the desired location, again touch inside the selection frame with the pen, and then move the section to the desired location.
-



7. Copying

* Before copying, press  so that it changes to , and then select the section to be copied. (Refer to page 17.)

- 1** Follow the procedure described in “1. Drawing a Circle” to draw an circle.
- 2** Follow the procedure described in “4. Selecting” to select the section to be copied.
- 3** Press . The selected section is copied.
 - * The operation sound allows you to check whether or not the key was correctly pressed. (Refer to page 8 about adjusting the operation sound volume.)
- 4** Touch inside the red frame (selection frame) with the pen, and then drag the pen along the screen. The copied section is moved to the desired location.
- 5** When the section is moved to the desired location, remove the pen from the screen.

Notes

- If the section could not be moved to the desired location, again touch inside the selection frame with the pen, and then move the section to the desired location.

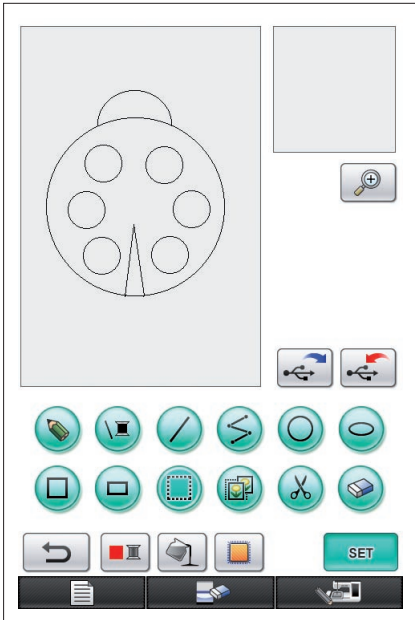

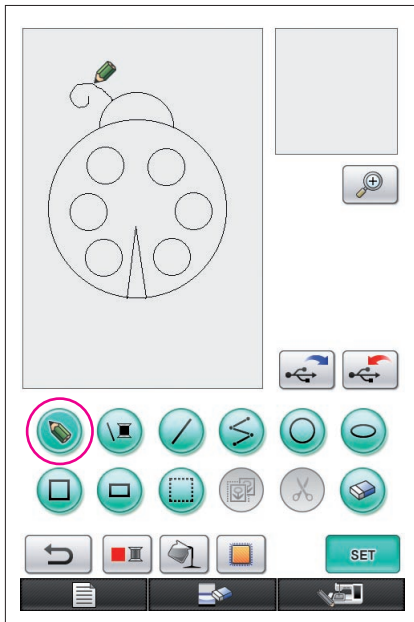

Once the circle is copied, repeat the procedure to create a desired drawing.



8. Drawing Lines Freehand

If the freehand line key is selected, the pen can be used to freely draw lines on the screen as easily as drawing images and text on paper with a pen.

- 1 Press  so that it changes to . (When the application is started up, this key already appears as .)
- 2 Draw the images with the pen.



With the freehand line key, lines can be drawn freely; however, circles and straight lines cannot be drawn perfectly.

Caution

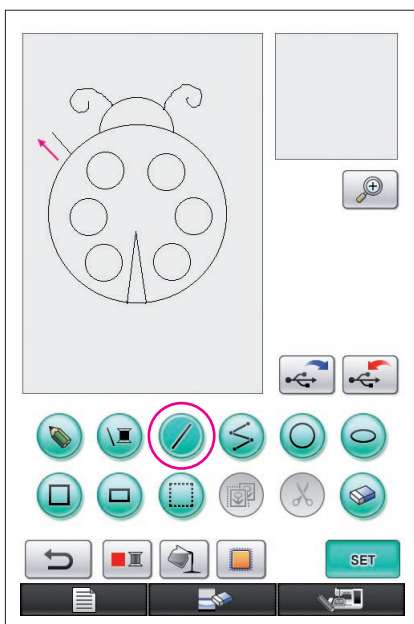
Do not try to fill an area with lines, otherwise the drawing cannot be converted to embroidery data.
We will draw the pattern in the following order.



9. Drawing a Straight Line

- 1 Press  so that it changes to .
- 2 Drag the pen along the screen until the line is the desired length.
- 3 When the line is the desired length, remove the pen from the screen.

To draw a straight line

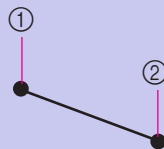



A straight line is drawn connecting the starting point with the ending point.

The length can be adjusted as desired until the pen is removed from the screen.

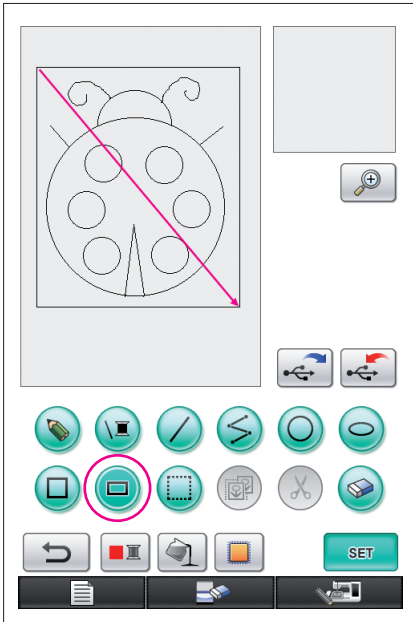
- ① Starting point
- ② Ending point



10. Drawing a Rectangle

- 1 Press  so that it changes to .
- 2 From a point that will be a corner of the rectangle, drag the pen along the screen until the rectangle is the desired size.
- 3 When the rectangle is the desired size, remove the pen from the screen. This completes the drawing.

To draw a rectangle or square

Use  to draw rectangles. The rectangle is drawn with the line connecting the starting point and the ending point as the diagonal.

* An angled rectangle, like the one shown at the right, cannot be drawn.



- ① Starting point
- ② Ending point

Use  to draw squares. The square is drawn with all sides having the length of the longest side of a rectangle whose diagonal is a line connecting the starting point and the ending point.



* An angled square, like the one shown at the right, cannot be drawn.



- ① Starting point
- ② Ending point



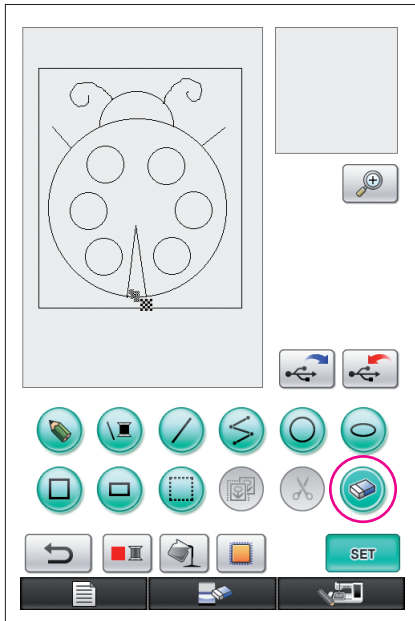

The size can be adjusted as desired until the pen is removed from the screen.

■ Creating the Desired Drawing

Unnecessary lines and lines not drawn as desired can be erased by pressing . Lines can also be deleted by pressing , as described in “5. Deleting Lines (Drawing a Half Ellipse)” on page 18; however, to erase detailed sections or if the desired area cannot be surrounded by a selection frame, press . Use the appropriate method as necessary.



Erasing Lines Using

- 1 Press  so that it changes to .
- 2 Touch the screen.  appears. Drag the pen back and forth to trace  along the area that you want to erase.

Notes



- If the erase key is used, the area can easily be erased if it is enlarged. See page 24.

Working With Detailed Sections

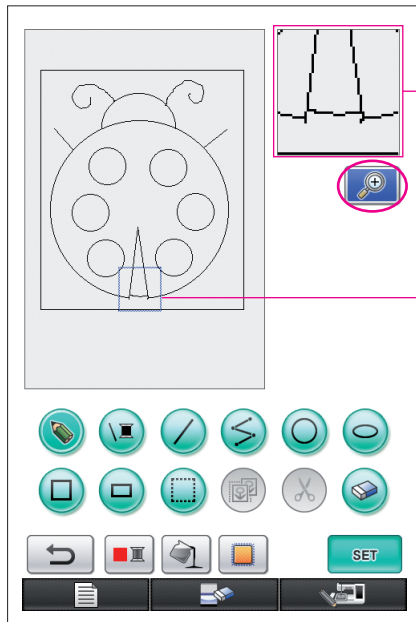
Working within the enlarged area makes it easier to draw or erase detailed lines.



Working Within the Enlarged Area

- 1 Press  so that it changes to .
The blue frame and the enlarged area appear. The section of the pattern within the blue frame is shown enlarged.
 - ① Enlarged area
 - ② The blue frame indicates the section that is enlarged.
- 2 With the pen, touch the part of the pattern in the pattern drawing area that you want to enlarge.
- 3 The blue frame moves to the part of the pattern that was selected and that part is shown enlarged in the enlarged area.

Notes



- To change the area that is displayed, drag the pen along the screen to move the blue frame.

- 4 The pattern needs to be edited from within the enlarged area. The operations are performed in the same way that they are in the pattern drawing area.



Caution

The pattern cannot be edited from the pattern drawing area while the enlarged area is displayed.

■ Closing the Enlarged Area



- 1 Press  so that it changes to .

Precautions on Drawing

- Do not try to fill an area with lines, otherwise the drawing cannot be converted to embroidery data.
- Color can only fill an outlined area. Be sure to design the area that you wish to fill with color so that it is outlined. In addition, a very small area (thin area) cannot be filled.
- After selecting the color of an area, lines of the drawing other than those drawn freehand cannot be edited or added. To change a line other than one drawn freehand, press  to return the drawing to the point before the first color of an area was selected. Before adding color to the drawing, be sure that the shape of the lines is as desired.
- The number of drawing operations are limited. Once this limit is reached, the error message shown at the right appears and no operation other than pressing  can be performed.



Once the drawing is finished, add colors as desired.

- * If no colors are to be added, continue with the procedure described in “3 Specifying Stitching Settings” on page 31. If a stitching method is not to be specified, continue with the procedure described in “4 Converting to Embroidery Data” on page 35.
- * To clear the entire area and start a new drawing, press . All data that had been drawn is erased, and the screen appears as it did when On Screen Designer™ was started up (see page 45).
- * To close the application and use the sewing machine, press . All data that had been drawn is erased (see page 46).
- * To save created data, continue with the procedure described in “Saving Image Data” on page 42.

Next, we will add color to the lines and areas.

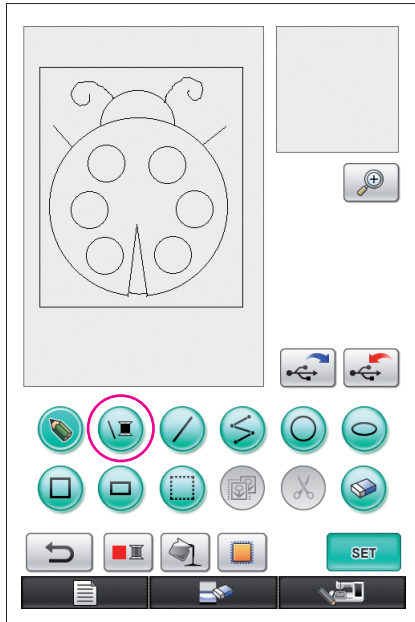

1. Selecting the Line Color

1 Press .

* When the application is started up, the line color is black.

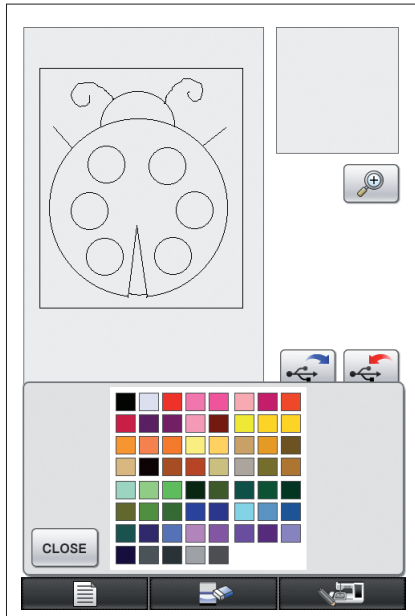

2 The screen shown at the left appears.

3 Touch the thread color showing the desired color. For this example, select black.

When a color is selected, the palette is automatically closed.

The color of the lines in the pattern and  changes to the selected color.

* To quit selecting a color, press .

* The line color can also be selected before the line is drawn or while it is being drawn.

* The color of the lines in the pattern can be changed even after a line color is selected.

* After the color of an area is selected, the color of the lines cannot be changed. To change the color of the lines, undo all operations until the drawing returns to the condition before the first area color is selected.

Notes

- An area cannot be filled with the same color selected for the lines.

2. Selecting the Area Colors

1 Press .

* Press  when the following message appears.

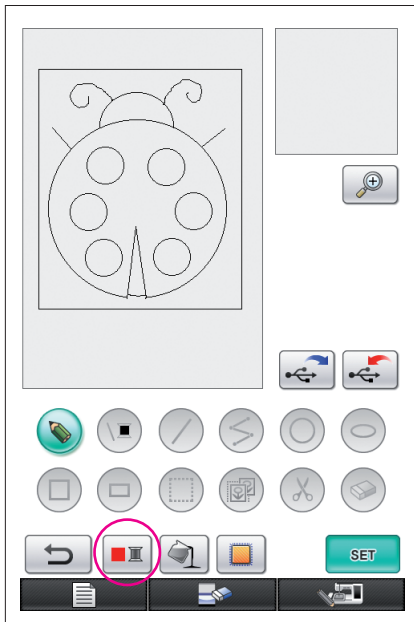
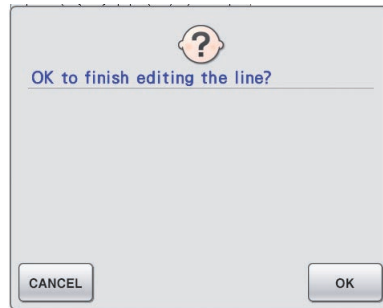

2 The screen shown at the left appears.

3 Touch the thread color showing the desired color. For this example, select red.

* To quit selecting a color, press .

Notes

- The color selected for the lines is not available in the palette of colors for the areas. The color selected for the lines cannot be selected for an area.

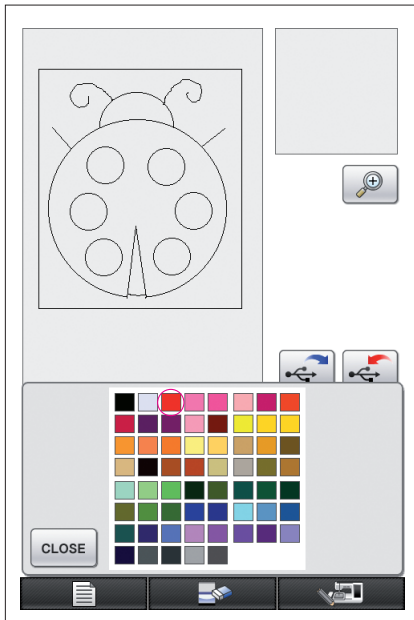

If you wish to embroider the area with the same color as the lines, select a different color in the pattern, but use the same color of thread when embroidering.

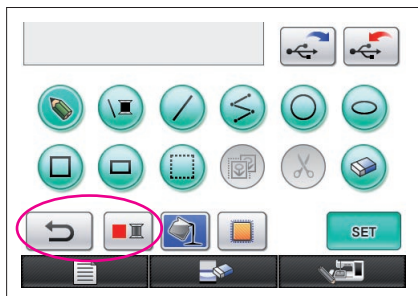



4 When a color is selected, the palette is automatically closed.

The color changes to the color selected with .

In addition,  changes to , indicating that an area can be filled with the selected color.

* After the color of an area is selected, lines of the drawing other than those drawn freehand to close openings cannot be added, edited or their color changed. To change a line, continue pressing  until the drawing returns to the condition before the first color of an area was selected.

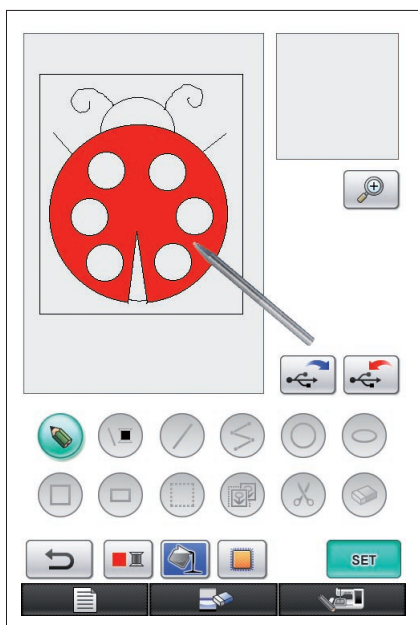

5 Touch the area to be filled with the color. The area is filled with the color.

Notes _____

- Color can only fill an outlined area. If the desired area is not filled with color or if an area that you did not want to fill with color is filled, correct the lines. (Refer to “Color Is Not Correctly Added” on page 29.) In addition, a very small area (thin area) cannot be filled with color. In this case, continue pressing  until the drawing returns to the condition before the first color of an area was selected, and then correct the lines to make the area larger.

6 Fill the other areas with color as described in steps 1 through 5.

If you fill the wrong area or if you wish to change the color, repeat steps 1 through 5 to change the color.

Notes _____

- The order in which colors are added is the same as the sewing order.

Color Is Not Correctly Added

Only outlined areas can be filled with color correctly. If an area will not be filled with correct color or will not be filled with color at all, that area is not completely surrounded by lines.

Use  to correct the lines so that the areas are outlined.

Correcting

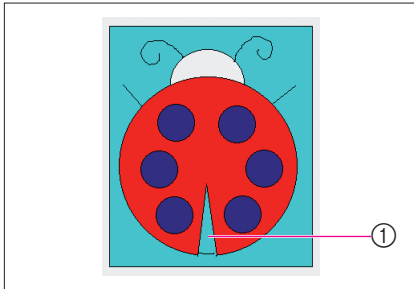



Example

The area inside the ladybug was also filled with the background color.

Because the drawing of the shape of ladybug is not completely enclosed, we must search for the openings and close them.

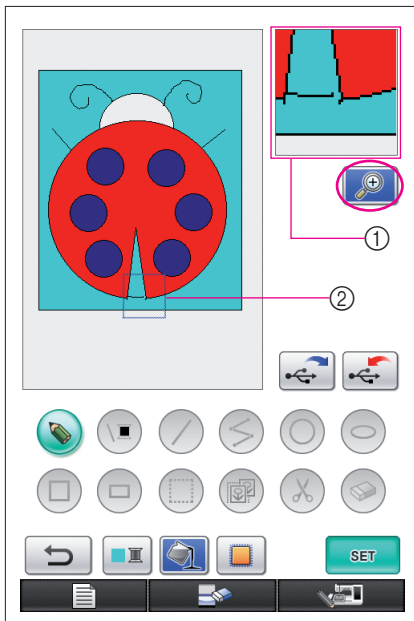
- ① The color of this area is not correct.





- 1 Press  so that it changes to .

The blue frame and the enlarged area appear. The section of the pattern within the blue frame is shown enlarged within the enlarged area.

- ① Enlarged area
- ② The blue frame indicates the section that is enlarged.

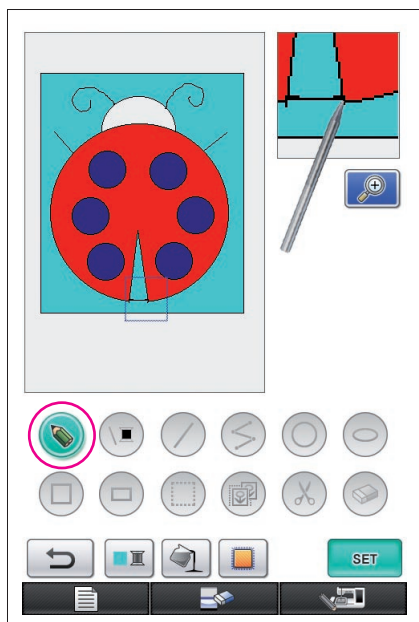
- 2 Touch the screen with the pen to move the blue frame and find the openings in the line.



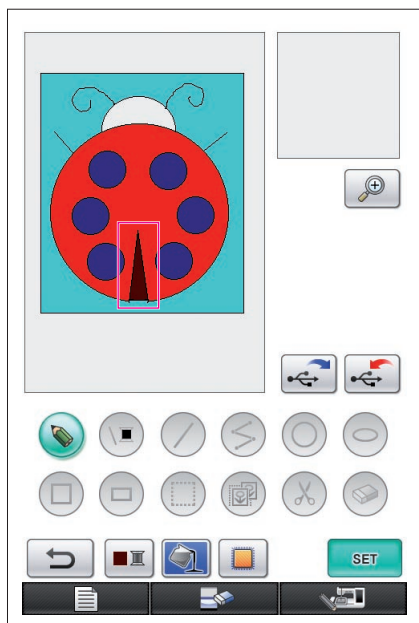

3 After finding the opening, press  so that it changes to .

4 Within the enlarged area, close the opening in the line.



5 Change the color of the area with the incorrect color as described in steps 1 through 5 of “2. Selecting the Area Colors” on page 27.

After colors are specified for all areas, specify the stitching settings

- * If the stitching settings are not to be specified, continue with the procedure described in “4 Converting to Embroidery Data” on page 35.
- * To erase the entire drawing and start a new one, press . All data that had been drawn is erased, and the screen appears as it did when On Screen Designer™ was started up (see page 45).
- * To close the application and use the sewing machine, press . All data that had been drawn is erased (see page 46).
- * To save created data, continue with the procedure described in “Saving Image Data” on page 42.

Lines of the drawing are sewn with satin stitches and areas are sewn with fill stitches. The following settings can be specified.

- ① Satin stitch (lines): thickness and stitch density
- ② Fill stitch (areas): sewing direction and stitch density

If the drawing data is saved, the settings can be changed after a trial embroidery of the design is sewn. (Refer to “Saving Image Data” on page 42.)

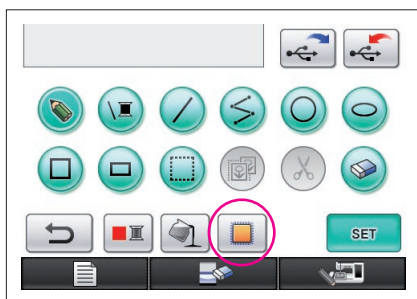

1. Displaying the Stitching Settings Screen

- 1 Press .
- 2 The screen shown at the left appears.

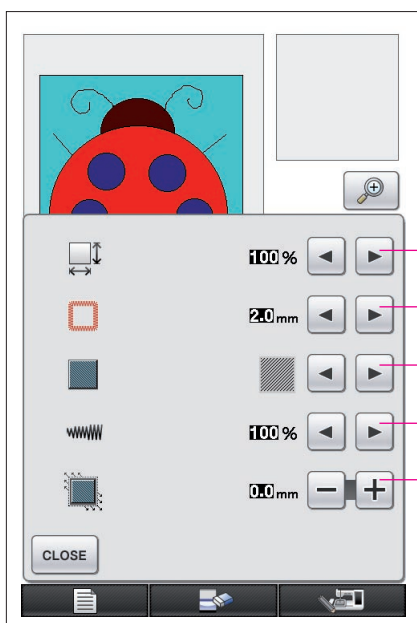

- ① Reduces the size of the pattern
The size of the drawn pattern can be changed. (Refer to page 34.)
- ② Specifies the width of the satin stitches used to sew the lines of the drawing (Refer to page 32.)
- ③ Specifies the sewing direction for fill stitches (Refer to page 32.)
- ④ Specifies the stitch density (Refer to page 33.)
- ⑤ Corrects shrinkage
When sewing embroidery, stitched areas may shrink. If this happens, the stitching can be corrected to prevent shrinkage. (Refer to page 47.)

* To quit specifying settings, press .

Notes

- You can use the pen tablet for operations in the stitching settings screen while moving tablet pen without touching tablet until you are ready to make selection.

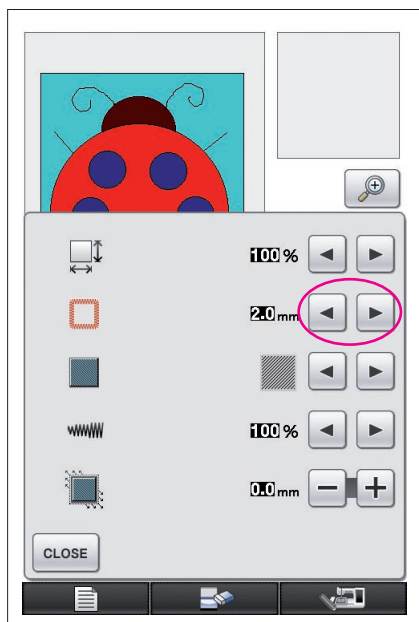

2. Specifying the Width of Satin Stitches

- 1 Press or beside .

(The default setting is 2.0 mm when the application is started up.)

To select a narrower width, press . To select a wider width, press .

Each press of makes the width narrower by 0.5 mm.

Each press of makes the width wider by 0.5 mm.

A setting between 1.0 mm and 3.0 mm in 0.5 mm increments can be specified.

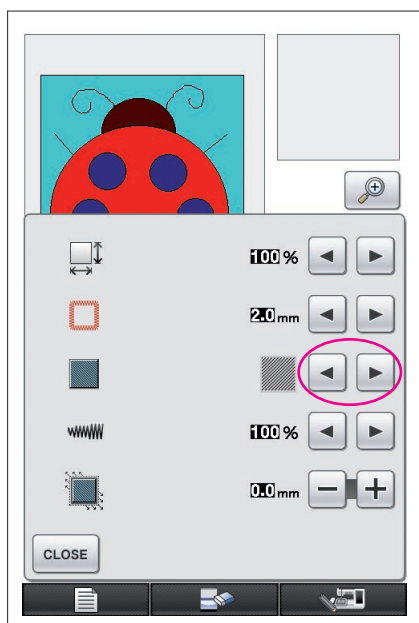
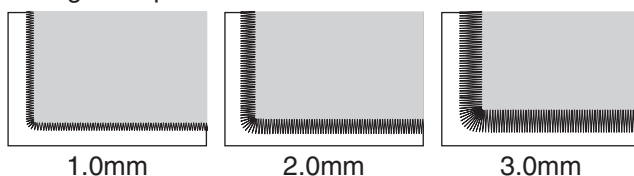

Setting examples



3. Specifying the Sewing Direction of Fill Stitches

- 1 Press or beside .

(The default setting is  when the application is started up.)

Each press of changes the setting in the following order:  →  → . Press to reverse the order of .

Setting examples

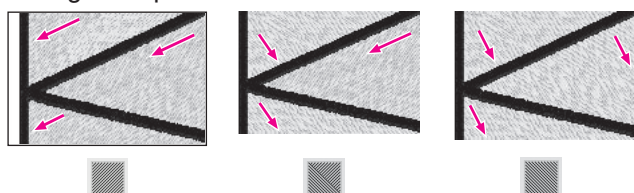

Notes

- If the size of the created pattern is larger than 10 cm × 10 cm, it is recommended that  be set in order to prevent shrinkage.

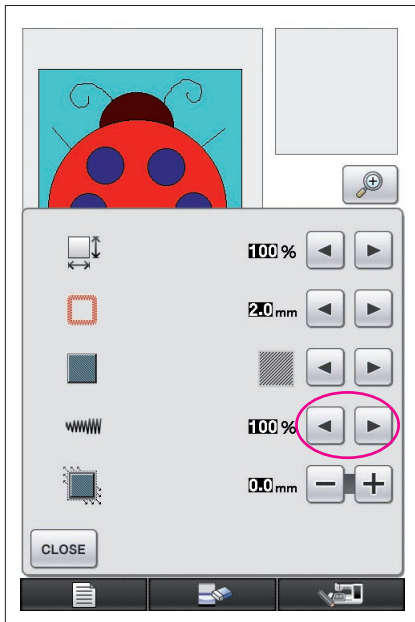

4. Specifying the Stitch Density

1 Press or beside .

(The default setting is 100 % when the application is started up.)

To select a coarser density, press . To select a finer density, press .

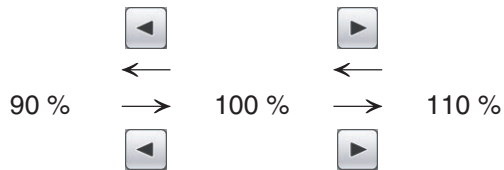

Setting examples

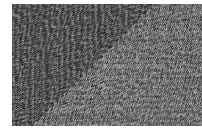
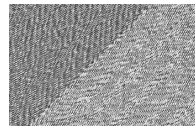
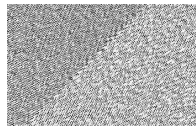

90 % (coarse) 100 % (standard) 110 % (fine)

Notes

- It is recommended that a finer stitch density be selected if a detailed drawing is created.
- If areas of the embroidery shrinks when a trial embroidery of the design is sewn, specify a coarser stitch density. Continue sewing trial embroidery while adjusting the stitch density.

2 After the desired settings are specified, press . The screen returns to the one displayed before the stitch settings screen was displayed.

Additional Functions

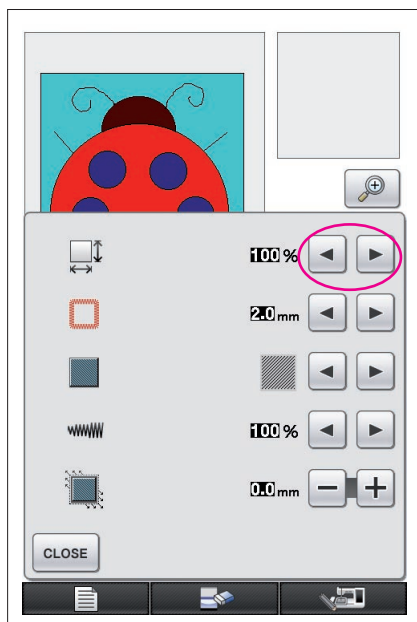

Reducing the Pattern Size

The size of the created pattern can be changed. Select a size from 50%, 70% and 100%.

Notes

- The pattern can also be enlarged or reduced from the embroidering or embroidery-editing screen of the sewing machine. If the desired size cannot be selected with this software or if a specific size is required, adjust the size from the sewing machine.

- Press in the pattern drawing screen. The screen shown at the left appears.
- Press or beside . Press once to reduce the size to 70%. Press again to reduce the size to 50%. To return the size to the original size (100%), press .
- Press . The screen returns to the one displayed before the stitch settings screen was displayed.

After the stitching settings are selected, convert the image data to embroidery data.

- * To clear the entire area and start a new drawing, press . All data that had been drawn is erased, and the screen appears as it did when On Screen Designer™ was started up (see page 45).
- * To close the application and use the sewing machine, press . All data that had been drawn is erased (see page 46).
- * To save created data, continue with the procedure described in “Saving Image Data” on page 42.

Now, the created image data can be converted to embroidery data.

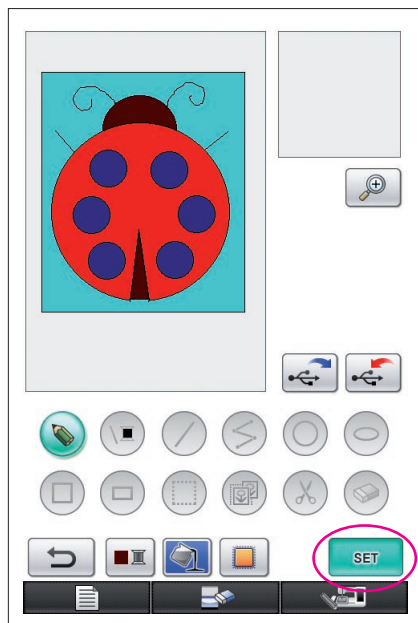

1 Press **SET**.

The following message appears.

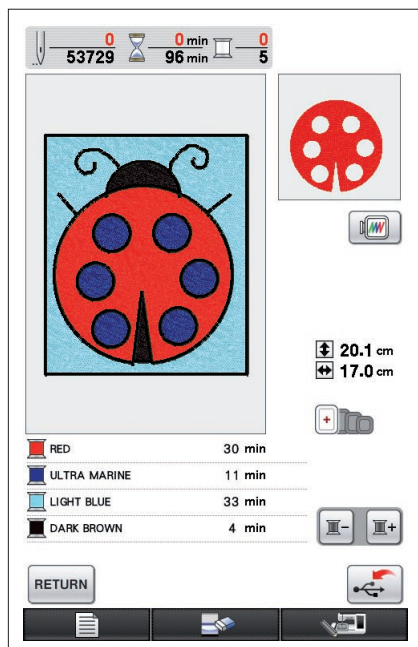
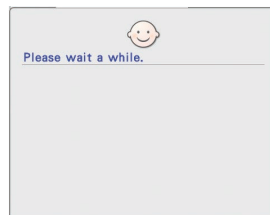

2 If the image data is correctly converted to embroidery data, the embroidery data check screen shown at the left appears. The pattern moves to the center of the embroidery pattern display area and the embroidery data is displayed.



If the message shown at the left appears, either the drawing contains too many lines or the design is too complicated to be converted to embroidery data.

Press **CLOSE** to return to the pattern drawing screen, and then correct the data.

In this screen, the number of thread colors and the number of stitches in the created pattern can be checked. For details on the various displays, refer to "Embroidery Data Check Screen" on page 12.

To change the pattern, press **RETURN** to change the embroidery data back to image data and display it in the pattern drawing screen.

* However, lines of the drawing other than those drawn freehand to close openings cannot be added, edited or their color changed. To change a line, continue pressing **RETURN** until the drawing returns to the condition before the first color of an area was selected.

Viewing an Image of the Embroidered Pattern

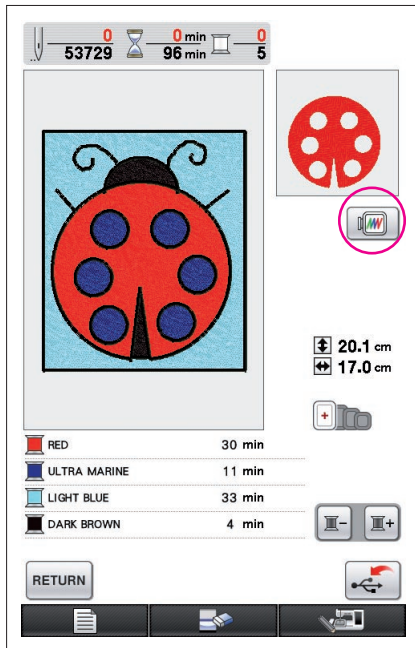

1 Press .

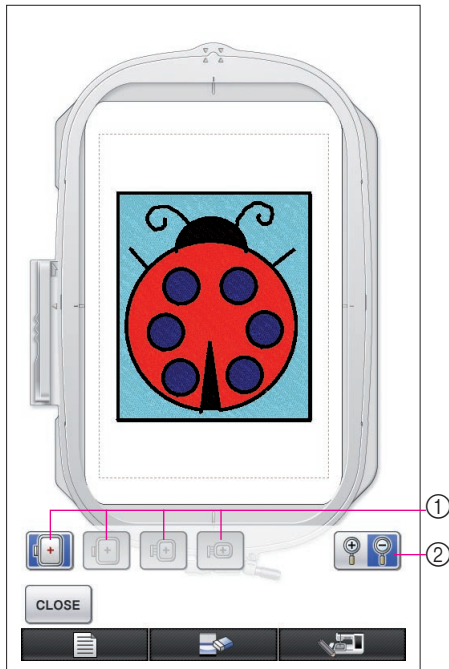

2 An image of the pattern as it will be embroidered appears.

- ① Press these keys to display the pattern in the various sizes of embroidery frames. The embroidery frames that appear in gray on the gray keys cannot be selected.
- ② Press this key to display the pattern enlarged.

3 Press  to return to the previous screen.

5

Saving the Embroidery Data

The embroidery data can be saved on USB media.

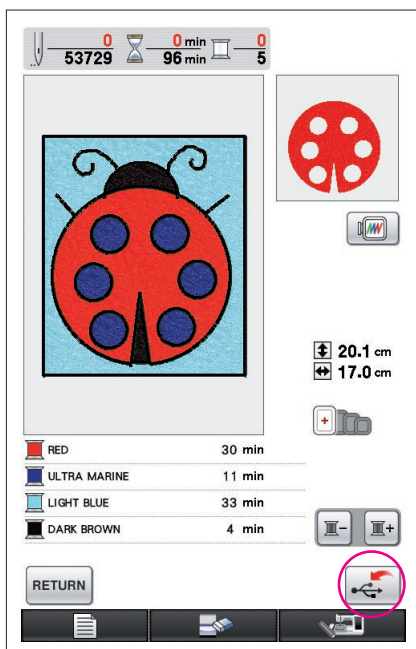

Notes

- Saved embroidery data cannot be recalled with On Screen Designer™. To recall data and edit it with On Screen Designer™, save the image data on USB media before converting it to embroidery data or press **RETURN** after the conversion to return to the pattern drawing screen, and then save the image data on USB media. (Refer to “Saving Image Data” on page 42.)

1 Press .

2 The screen shown below appears. If the embroidery data was saved successfully, the previous screen automatically appears.

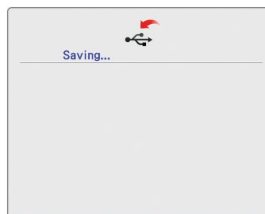

Notes

- Do not turn off the machine while the [Saving] message is displayed, otherwise the embroidery data being saved may be lost. In addition, while saving the data onto USB media, do not try to remove the USB media, otherwise the USB media may be damaged.

■ If the Embroidery Data Cannot Be Saved

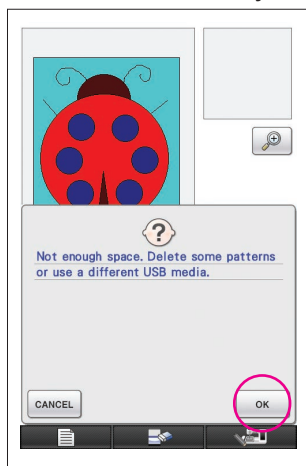

If the screen shown at the left appears, the embroidery data cannot be saved because the USB media is full or the embroidery data being saved is larger than the amount of space available. To be able to save the embroidery data, previously saved embroidery data must be deleted.

* To quit saving, press **CANCEL**.

Deleting Saved Data

1 Press **OK**.

* To change the USB media, press **CANCEL**.

2 The following message appears.

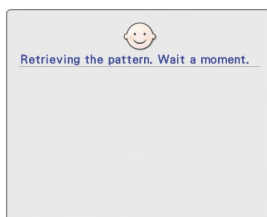

Notes

- Do not turn off the machine while this message is displayed, otherwise saved data may be lost. In addition, do not try to remove the USB media, otherwise the USB media may be damaged.
-

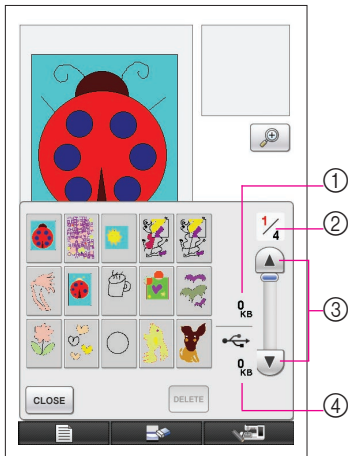

3 A list of saved embroidery data is displayed.

* When saving onto USB media containing data other than embroidery data, such as image data, nothing is displayed.

Press **CLOSE**, and then change the USB media.

* To quit recalling, press **CLOSE**.

4 Select the pattern to be deleted.

① If a pattern is selected to be deleted, the size of the data for the selected pattern is displayed.

② The page number for the displayed list and the total number of pages are displayed.

③ Each page of the list shows 15 embroidery patterns. To view the next page, press **▼**. To view the previous page, press **▲**.

④ The amount of space available on the USB media is displayed.

* If there is only one page, ③ and ④ do not appear.

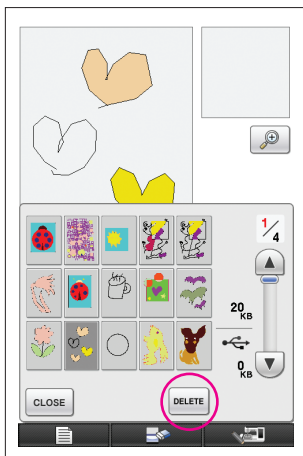

5 Press **DELETE**.

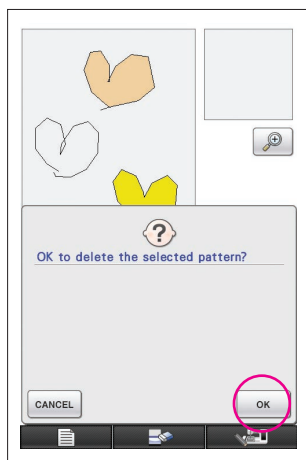

6 To delete the selected pattern data, press .

* To stop the process, press .

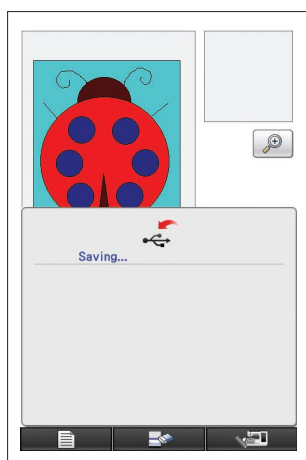

7 The embroidery data is deleted, and if the required amount of free space is made available, the new embroidery data is automatically saved. If the amount of free space is not enough, another saved embroidery pattern must be deleted.

* When saving onto USB media containing data other than embroidery data, such as image data, it may not be possible to save the new embroidery data, even after embroidery data is deleted. In this case, press , and then change the USB media.

If the embroidery data was saved successfully, the previous screen automatically appears.

* Saving embroidery data takes approximately 3 seconds.

Notes

- Do not turn off the machine while the [Saving] message is displayed, otherwise the embroidery data being saved may be lost.

Chapter 3 Other Functions

Tracing a Picture using the Pen Tablet

You can draw beautiful pictures using the pen tablet, even if you are not very good at drawing. Find a favorite picture and print out onto paper to use for a tracing pattern.

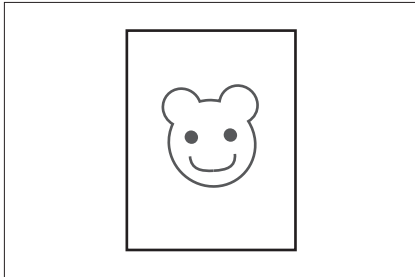

1 Connect the pen tablet to the sewing machine. Refer to the Instruction and Reference Guide included with the pen tablet for the details on how to use the pen tablet.

2 Select a favorite picture for creating an embroidery pattern.

Notes

- Use thin paper as thick paper may block the sensitivity of the pen tablet.

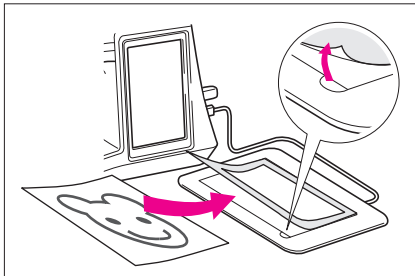

3 Insert the picture under the tablet sheet.

4 Press  so that it changes to .

5 Using the tablet pen, slowly trace the picture.

Notes

- Working area of the pen tablet differs depending on performing functions of the sewing machine.

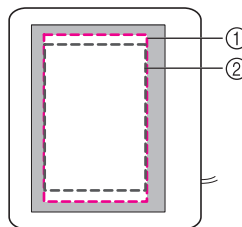
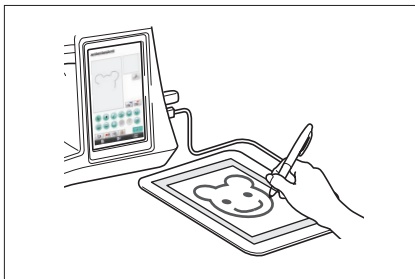

① Working area when using the pen tablet for the purpose other than drawing

② Working area when drawing with the pen tablet

- Do not draw the line too fast; otherwise the line may create breaks.

6 Follow the procedure described from “2 Adding Color to the Pattern” on page 26 through “5 Saving the Embroidery Data” on page 37 to finish creating the pattern.

Notes

- When you create the embroidery pattern by tracing the picture using the pen tablet, the actual size of the pattern will be bigger than the tracing picture. Check the size of the pattern before embroidering, then change the size of the pattern on the sewing machine if needed.

Saving Image Data

Saved data that has been converted to embroidery data cannot be recalled with On Screen Designer™. To recall data and edit it with On Screen Designer™, save the image data on USB media before converting it to embroidery data or press **RETURN** after the conversion to return to the pattern drawing screen, and then save the data.

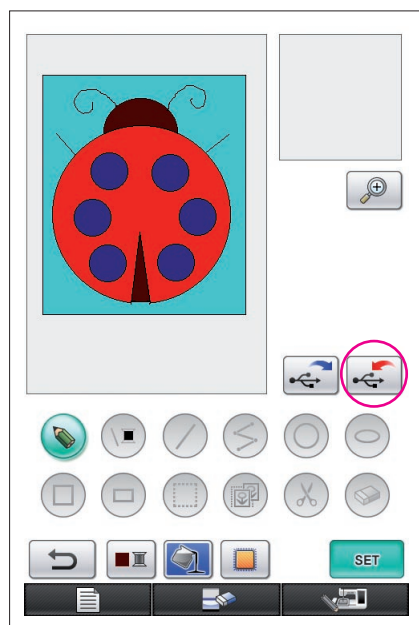



1 Insert USB media into the USB port located on the right side of the machine.

Caution

- Do not insert anything other than USB media into the USB media port. Otherwise, the USB media drive may be damaged.
- Do not insert USB media containing pattern data other than those saved using this application. (Only .pm7 and .phc data can be used.)

2 Press .

- * If the pattern is displayed in the enlarged area, the enlarged display will be canceled, then the pattern is saved.
- * If the  key or the  key is selected when saving data before the area thread color key has been selected, the  key will be selected instead, then the pattern is saved.

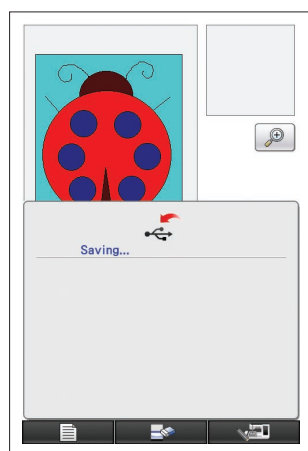

3 The screen shown at the left appears. If the image data was saved successfully, the previous screen automatically appears.

- * Saving image data takes approximately 3 seconds.

Caution

Do not turn off the machine while the [Saving] message is displayed, otherwise saved data may be lost. In addition, do not try to remove the USB media, otherwise the USB media may be damaged.

■ If the Image Data Cannot Be Saved

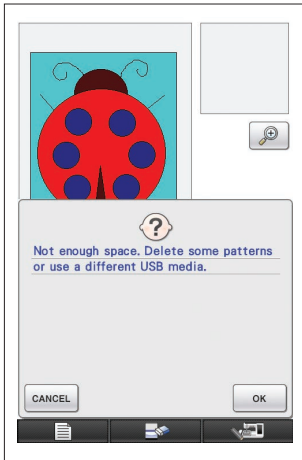

If the screen shown at the left appears, the image data cannot be saved because either the USB media is full or the embroidery data being saved is larger than the amount of space available. To be able to save the image data on the USB media, previously saved image data must be deleted.

* To replace the USB media or quit saving, press **CANCEL**.

Image data is deleted in the same way that embroidery data is deleted. For details, refer to page 38.

* Data cannot be saved on the USB media in the following cases.

- When saving onto USB media containing data other than image data, such as embroidery data, and a list of image data does not appear even when **OK** is pressed.
- When saving onto USB media containing data other than image data, such as embroidery data, and the new image data is not saved even when other image data is deleted.

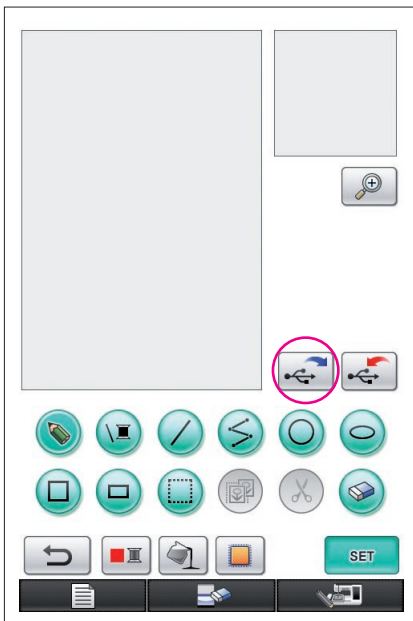

Press **CANCEL**, and then change the USB media.

Recalling Image Data



1 Insert USB media containing image data into the available USB port located on right side of machine.

2 Press  in the pattern drawing screen.

* The  key is not available when the pattern is displayed in the enlarged area. Press the  key to close the enlarged area.

3 The following message appears.

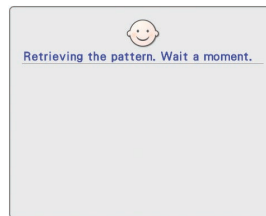

Caution

Do not turn off the machine while this message is displayed, otherwise saved data may be lost. In addition, do not try to remove the USB media while recalling data, otherwise the USB media may be damaged.

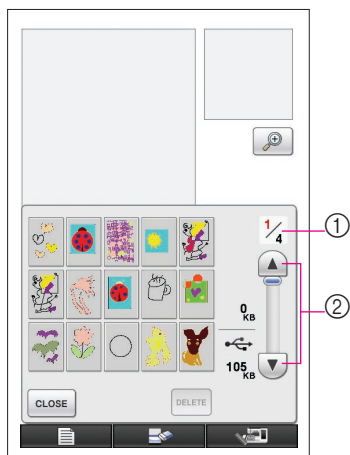

4 A list of saved image data is displayed.

5 Select the image data to be recalled.

6 The following message appears.

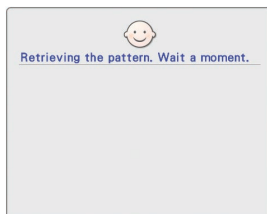

Caution

Do not turn off the machine while this message is displayed, otherwise saved data may be lost. In addition, do not try to remove the USB media while recalling data, otherwise the USB media may be damaged.

- ① The page number for the displayed list and the total number of pages are displayed.
- ② Each page of the list shows 15 image data. To view the next page, press . To view the previous page, press



* If there is only one page, ① and ② do not appear.

* To quit recalling, press .

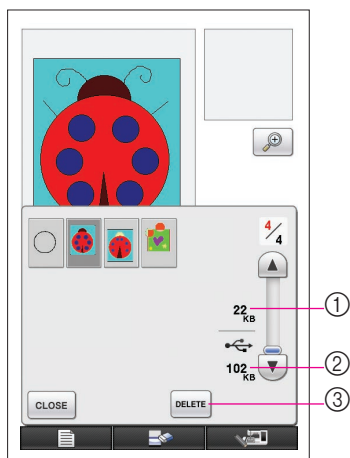

7 The selected image data is displayed.

- ① The size of the selected image data is displayed.
- ② The amount of space available on the USB media is displayed.
- ③ When pressed, the selected image data is deleted from USB media.

Caution

Before the image data is recalled, the currently displayed data is deleted. Be sure to save any necessary data before recalling image data.

8 Press .

Clearing The Screen

All operations that were performed can be stopped and the screen appears as it did when On Screen Designer™ was started up.

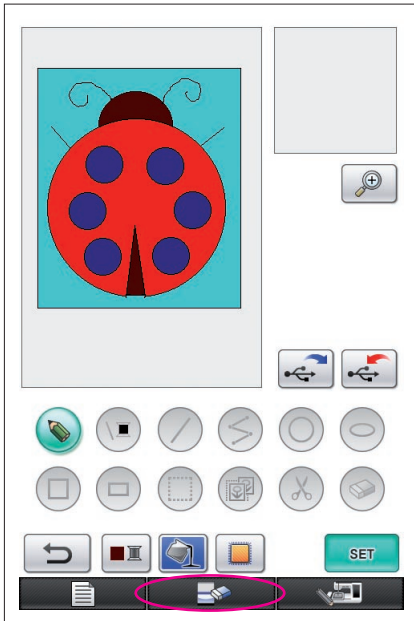

1 Press .

2 The following message appears.



3 To delete the data, press .

* To stop the process, press .

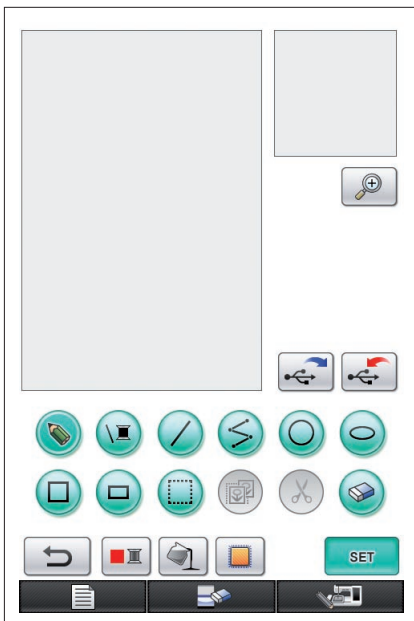

4 The screen appears as it did when the application was started up.

Notes

- Before resetting the screen, the currently displayed data is deleted. Be sure to save any necessary data before resetting the screen.

Closing The Application To Use The Sewing Machine

You can close the application to use the sewing machine without turning the machine off, then on again.

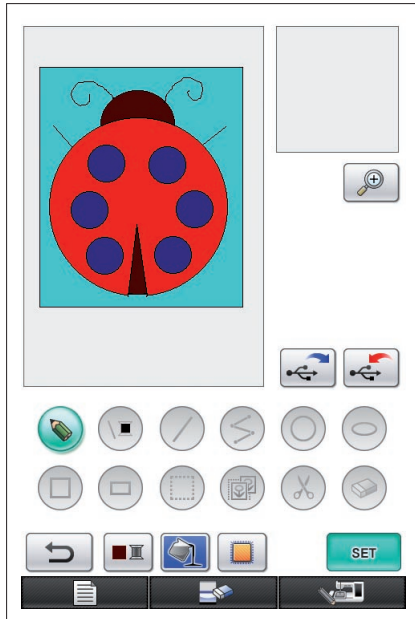

1 Press .

2 The following message appears.

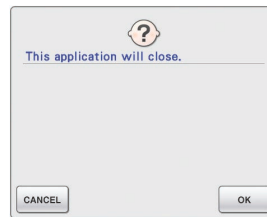

3 To close the application, press .

* To stop closing the application, press .

4 The home screen appears.

Notes

- Before closing the application, the currently displayed data is deleted. Be sure to save any necessary data before closing the application.

Correcting Shrinkage

When created embroidery data is sewn, areas of the embroidery may shrink. If this occurs, correct the shrinkage.

■ Shrinkage

The size of the pattern is enlarged and areas (fill stitches) shrink along the sewing direction. Since areas shrink while lines (satin stitches) are sewn with the size before shrinking, the lines and areas are no longer aligned.

In order to prevent this, adjust the length of the lines so that they are in the sewing direction and are larger than the original data.

0.3 mm





0.4 mm

← Sewing direction →
Original data

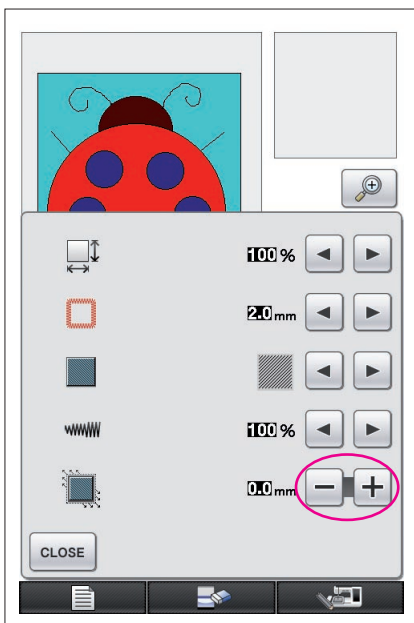

←← Sewing direction →→
Adjusted data

Each arrow represents a shrinkage adjustment value (0.1 mm increments)



1 Display in the pattern drawing screen the data with shrunken areas, and then press . The screen shown at the left appears.

2 Press  or  beside .

To lengthen the stitching, press . To shorten the stitching, press .

Each press of  makes the stitching longer by 0.1 mm.

Each press of  makes the stitching shorter by 0.1 mm.

A setting between 0.0 mm and 2.0 mm in 0.1 mm increments can be specified.

Notes

- Normally, the default setting of 0.3 mm is used.
- Continue sewing trial embroidery while making adjustments.
- The larger the pattern size, the easier shrinkage will occur.
- Shrinkage is also related to the sewing direction and stitch density of the fill stitches. Also try adjusting these settings.

Chapter 4 Troubleshooting

ERROR MESSAGES

If an operation is performed incorrectly, the buzzer sounds and an error message appears. If an error message appears, follow the instructions given in the error message to correct the problem. (The message that is displayed can be cancelled either by pressing  or performing the operation correctly.)



1 This message appears when a pattern is being saved.

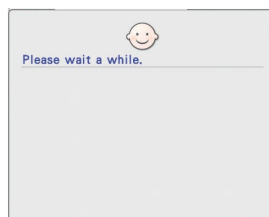

5 This message appears when image data is being converted to embroidery data.



2 This message appears when saved data will be deleted.



6 This message appears when image data is being converted to embroidery data, but the data is too complicated to be converted.

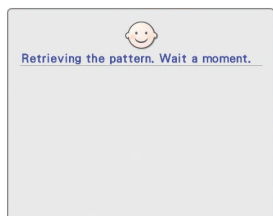

3 This message appears when image data or embroidery data is being recalled.



7 This message appears when the number of image data operations exceeds the limit.

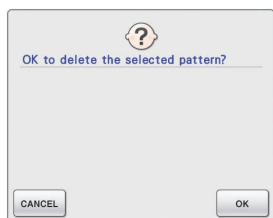

4 This message appears when a pattern is deleted.

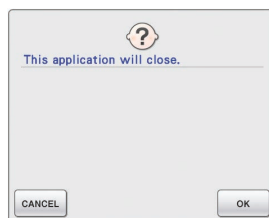

8 This message appears when the application is being closed.

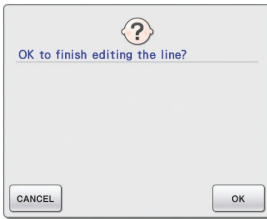

9 This message appears when  is first pressed.

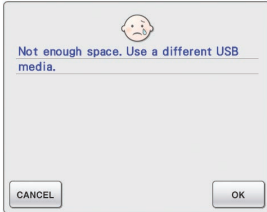

10 These messages appear when the size of the pattern data to be saved exceeds the amount of space available on the USB media.



11 This message appears while the USB media is transmitting.



12 This message appears when you try to recall or save a pattern while no USB media is loaded.



13 This message appears when you try to use incompatible media.



14 This message appears when you attempt to select a pattern after the USB media in which the pattern is saved has been changed.



15 This message appears when an error occurs with the USB media.