

admire™ air 7000
User's Guide

TABLE OF CONTENTS

1	Introduction	6	What Needle and Thread to Use	21
	Machine Overview	6	Placing the Thread Spools on the Spool	
	Front and Side of Machine	6	Pins	22
	Inside of Machine	7	Changing Thread	22
	Needle Area	8	Threading the Needles	23
	Accessories	8	Threading the Left Overlock Needle (A)	23
2	Preparations	9	Threading the Right Overlock Needle (B)	24
	Connect Foot Control and Power Supply	9	Threading the Chainstitch Needle (D)	25
	Before Using Your Machine for the First		Threading the Coverstitch Needles	26
	Time	9	Needle Threader	29
	Mount the Spool Stand	10	Threading the Loopers	30
	Mount the Telescopic Thread Stand	10	Threading the Upper Loper	30
	Waste Tray	10	Threading the Lower Loper	31
	Knee Lifter	11	Threading the Chainstitch Loper	32
	Front Cover	11	Threading Specialty Threads	33
	Flat Bed Extension / Free Arm	11	5 Stitches and Sewing Techniques	34
	Change Between Cutter Cover A and		Stitch Overview	34
	Coverstitch Table B	12	Start Sewing	41
	Presser Foot Lift	12	Pin Placement	41
	Change the Presser Foot	12	Securing the Thread Chain	41
	Needle Information	13	Cutting the Seams Open	42
	Checking the Needles	13	Rolled Edge Sewing	43
	Change the Needles	13	2-Thread Rolled Edge	43
	Upper Cutter Position	14	3-Thread Rolled Edge/Narrow Edge	43
	2-Thread Overlock Converter	14	Flatlock Sewing	44
	Upper Loper Position	15	Standard Flatlock, Wide	44
	Threading/Sewing Lever	15	Decorative Flatlock, Wide	44
	Stitch Finger Lever	15	Ladder Stitch	44
3	Touch Screen	16	Coverstitch Sewing	45
	Touch Screen Overview	16	Machine Set Up	45
	Select a Stitch	16	Start Sewing	45
	Stitch Recommendations	16	Securing the Coverstitch Seam End	45
	Info System	17	Chainstitch Sewing	46
	On-Screen Stitch Adjustments	17	Machine Set Up	46
	Thread Tension	17	Start and End Sewing	46
	Differential Feed	17	Sewing Tips & Hints	46
	Stitch Length	18	Sewing with Decorative Thread in the	
	Sewing Speed	18	Loopers	46
	Save a Stitch	18	Gathering with Differential Feed	46
	Personal Name	18	Sewing Corners	47
	Delete a Saved Stitch	19	6 Stitch Adjustments	48
	Load a Stitch	19	Presser Foot Pressure	48
	Settings Menu	19	Stitch Width Adjustment	48
	Sound	19	Adjustment Using Needle Position	48
	Language	19	Adjustment Using Cutting Width Dial	48
	Calibrate Touch Screen	20	Stitch Length Adjustments	49
	Pop-Ups	20	Differential Feed Adjustment	49
4	Threading	21	Thread Tension	50
	General Threading Information	21	Correct Tension	50
			Upper Loper Tension	50
			Lower Loper Tension	50
			Left Needle Tension	50
			Right Needle Tension	50

7	Maintenance	51
	Cleaning	51
	Cleaning the Looper Area	51
	Cleaning the Looper Threading Pipes	51
	Oiling	52
	Replace the Upper Cutter	52
	Storage	52
	Servicing.....	52
	Trouble Shooting	53
	Technical Specifications	56

1 Introduction

Machine Overview

Front and Side of Machine

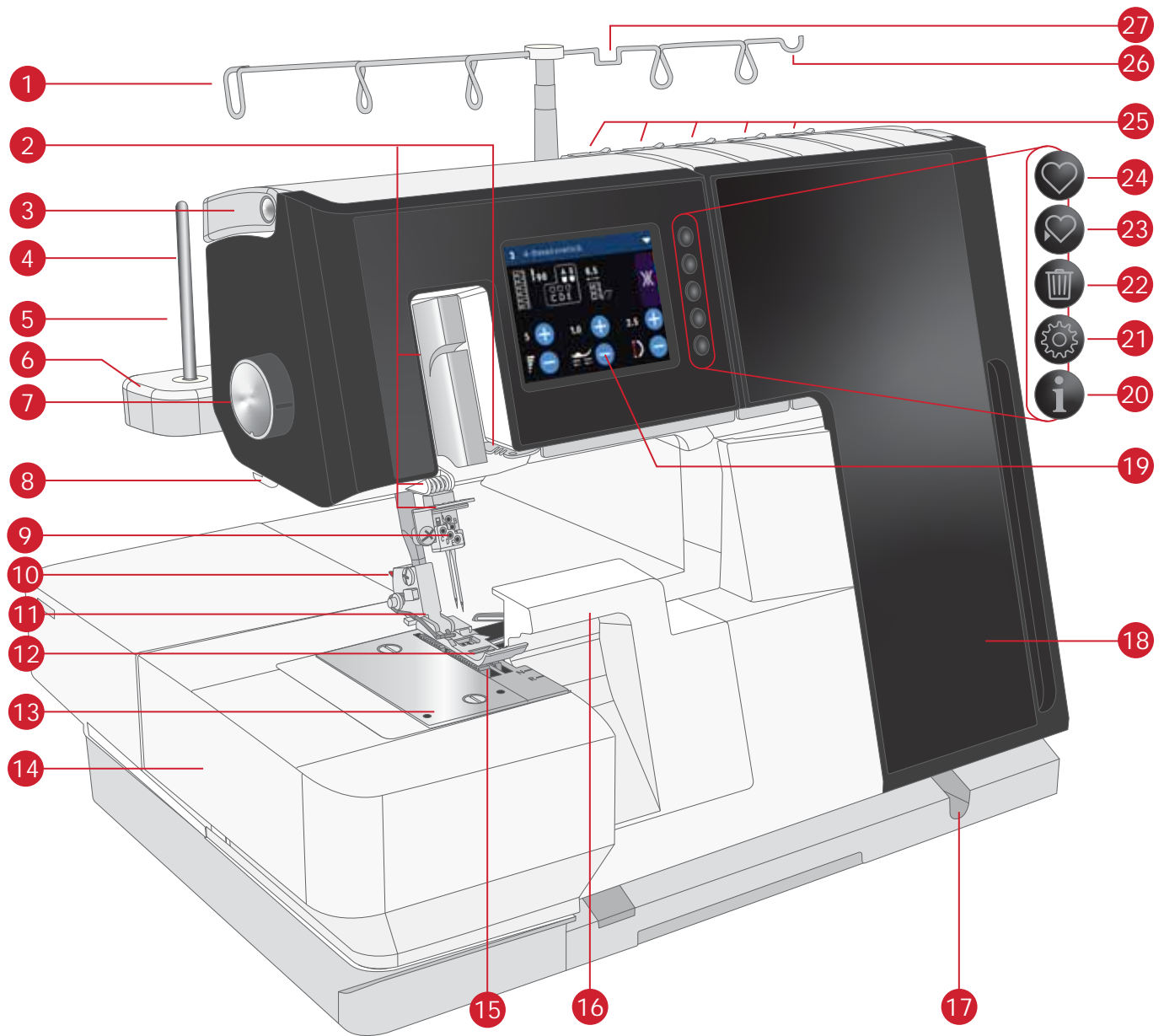

1. Telescopic thread stand
2. Thread guides
3. Handle
4. Spool pin
5. Cone holder
6. Spool stand
7. Presser foot pressure dial
8. Thread knife
9. Needle clamp

10. Presser Foot Release button
11. Presser foot ankle
12. Presser foot
13. Stitch plate
14. Flat bed extension
15. Feed teeth
16. Cutter cover A
17. Socket for knee-lift
18. Front cover

19. Color Touch Screen
20. Info button
21. Setting button
22. Delete button
23. Save stitch button
24. Load stitch button
25. Pre-tension thread guides
26. To hang a small scissors
27. To hang a tweezer

Inside of Machine

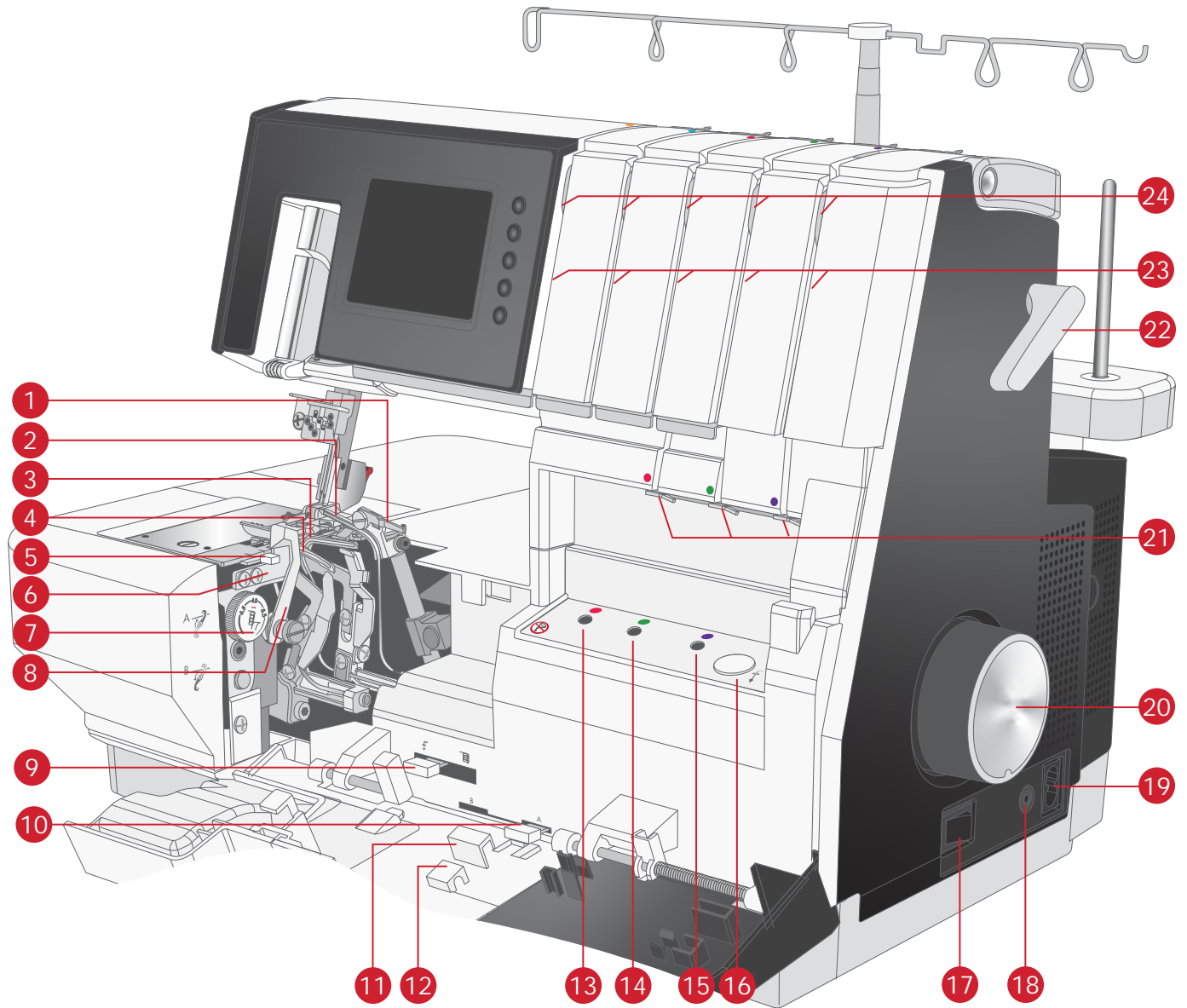

- 1. 2-thread converter
- 2. Upper looper
- 3. Lower looper
- 4. Chainstitch/Coverstitch looper
- 5. Stitch Finger lever
- 6. Stationary cutter
- 7. Cutting width dial
- 8. Upper cutter
- 9. Threading/Sewing lever

- 10. Upper looper position lever
- 11. Storage for tweezers
- 12. Storage for stylus
- 13. Upper looper threading hole
- 14. Lower looper threading hole
- 15. Chainstitch/Coverstitch looper threading hole
- 16. Threading button
- 17. On/Off button

- 18. Foot control socket
- 19. Power cord socket
- 20. Handwheel
- 21. Looper thread guides
- 22. Presser foot lifter
- 23. Threading slots
- 24. Tension discs

Needle Area

- A. Left Overlock Needle
- B. Right Overlock Needle
- C. Left Coverstitch Needle
- D. Middle Coverstitch Needle/Chainstitch Needle
- E. Right Coverstitch

Note: When using two needles, the left needle is positioned a little higher up than the right needle (they are not supposed to be 'level', like a twin needle).

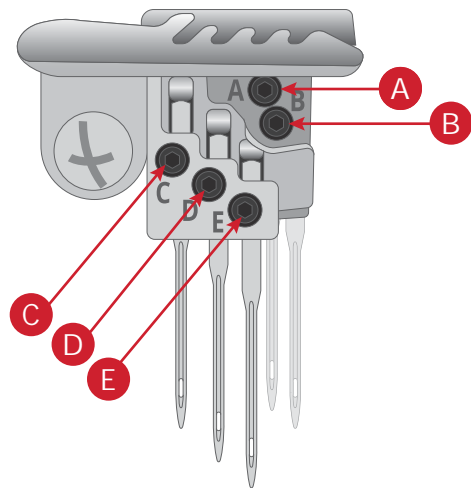

Accessories

- 1. Spool holder x 5
- 2. Spool cap x 5
- 3. Thread net x 5
- 4. Tweezer
- 5. Needle threader
- 6. Allen key
- 7. Screw driver
- 8. Brush
- 9. Sewing machine oil
- 10. Knife blade for upper cutter
- 11. Stylus
- 12. Coverstitch table B
- 13. Knee-lifter
- 14. Accessory box
- 15. Threading wire
- 16. Foot control
- 17. Waste tray (not pictured)
- 18. Soft dust cover (not pictured)
- 19. Needle pack (not pictured)
- 20. Extension table (not pictured)

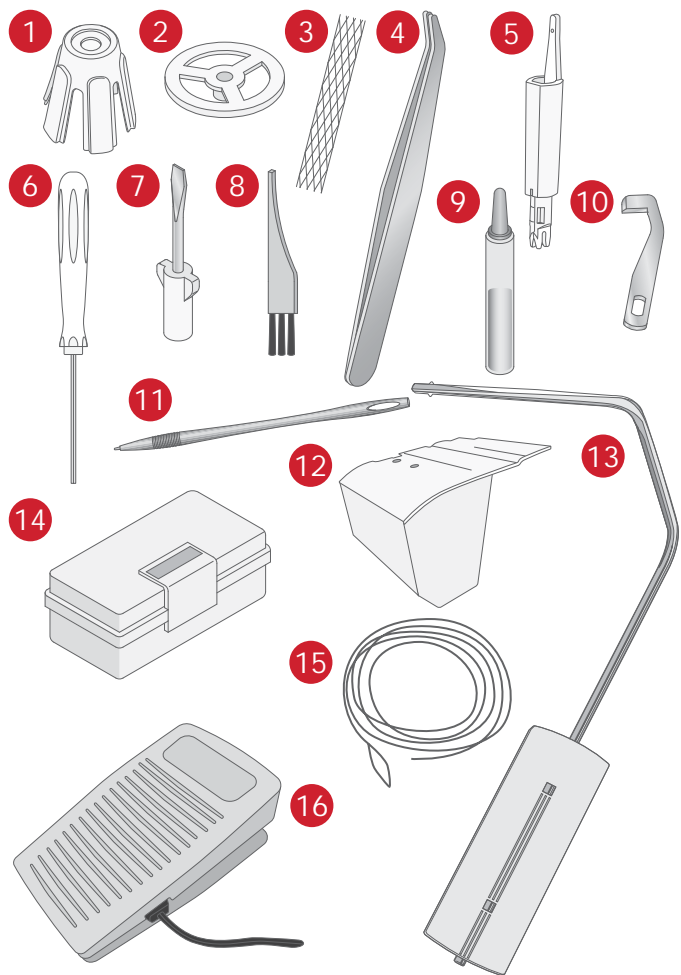

2 Preparations

Connect Foot Control and Power Supply

Among the accessories you will find the power cord and the foot control.

Foot control to use with this machine:

C-9000, manufactured by: CHIEN HUNG

Connect the foot control cord to the front socket on the bottom right side of the machine (A).

Connect the power cord to the rear socket on the bottom right side of the machine (B). Plug the cord into the wall socket.

Before plugging your machine in, make sure the voltage is the same as indicated on the plate under the machine. Specifications vary from country to country.

Press the ON/OFF switch to ON to turn on power and light (C).

Note: When the front cover is open the safety switch is activated and prevents the machine from sewing, even if the foot control is pressed.

Note: Your machine is adjusted to provide the best stitch result at normal room temperature. Extreme hot and cold temperatures can affect the sewn result.

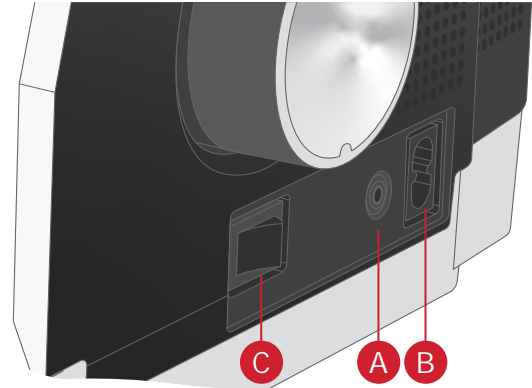

For the USA and Canada

This sewing machine has a polarized plug (one blade wider than the other). To reduce the risk of electric shock, this plug is intended to fit in a polarized outlet only one way. If the plug does not fit fully in the outlet, reverse the plug. If it still does not fit, contact a qualified electrician to install the proper outlet. Do not modify the plug in any way.

Before Using Your Machine for the First Time

Before using your machine for the first time, place a scrap of fabric under the presser foot and run the machine without thread for a few minutes. Wipe away any oil which may appear.

Mount the Spool Stand

Insert the two pins of the spool stand (A) into the slots (B) at the back of the machine.

Push the spool stand to the right to lock in place (C).

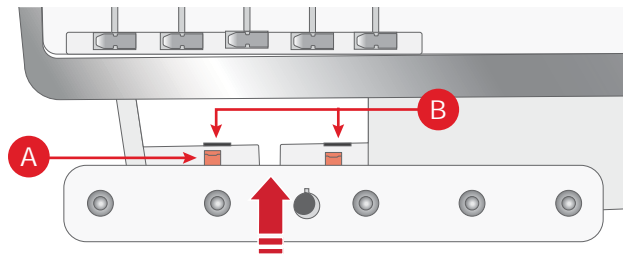

Machine from above

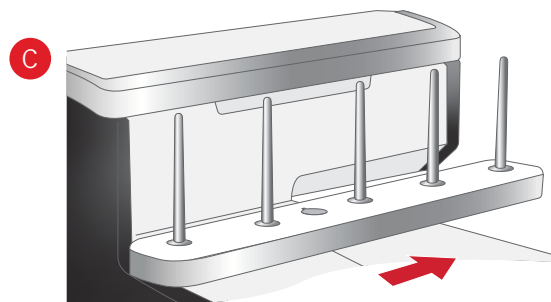

Mount the Telescopic Thread Stand

Insert the telescopic thread guide into the socket on the thread stand (A). Match the knob on the thread guide (B) with the slot (C) in the thread stand. Extend the telescopic thread stand to its full height, then turn until it clicks into place.

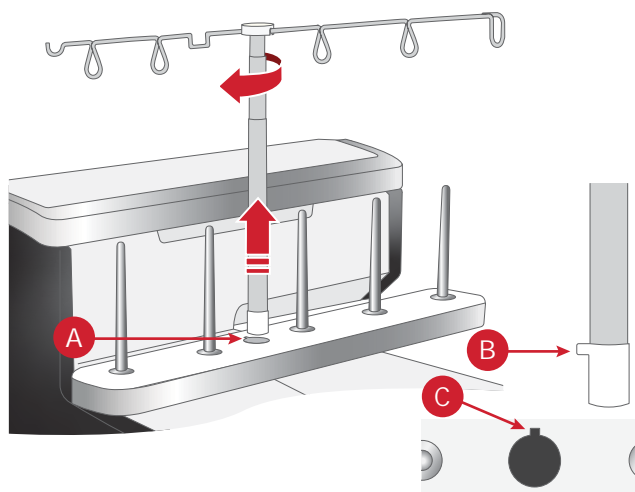

Waste Tray

The waste tray collects trimmings. Make sure the trim falls into the tray while sewing. Empty the tray after sewing.

Place the tray along the edge of the flat bed extension (A). Push the waste tray towards the front cover inserting the tabs into the slit under the front cover (B). Push until it clicks in place.

Pull the waste tray toward you to remove it.

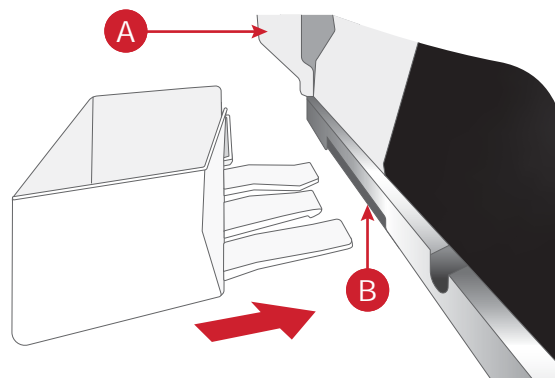

Knee Lifter

Your machine comes with a knee-lifter that allows you to lift the presser foot with your knee. This is very helpful when sewing, since it allows you to handle the fabric with your hands while your knee lifts the presser foot.

Match the ribs on your knee-lifter with the notches in the knee-lifter socket (A). Carefully push the knee-lifter into the socket. Adjust the rectangular bar on the knee-lifter until it is positioned at a comfortable height for you (B).

Press your knee towards the knee-lifter and to the right, and the presser foot will raise. You can raise the presser foot to two positions; up and extra lift position.

To remove the knee-lift, just pull it straight out of the socket.

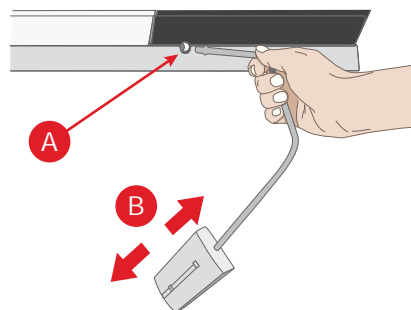

Front Cover

Open by pushing the cover to the right (1) as far as it will go and then pull it toward you (2).

Close it again by pulling the cover upward and then sliding it to the left until it locks.

Note: The Threading/Sewing lever must be set in sewing position to be able to close the front cover.

Note: The front cover has a safety switch and the machine will not sew if the front cover is open.

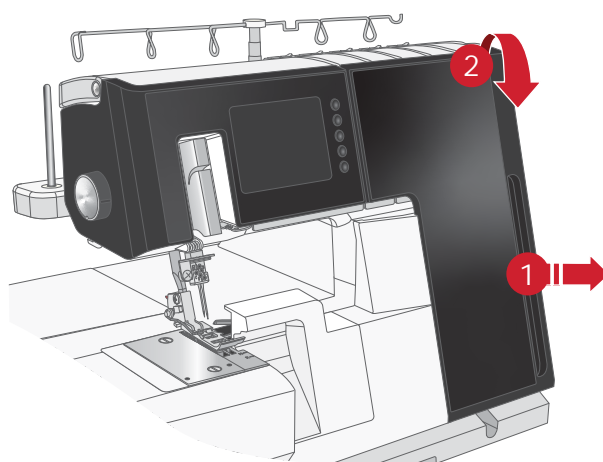

Set the machine in sewing position before closing the cover

Flat Bed Extension / Free Arm

To use free arm, remove the flat bed extension cover. The free arm is convenient for sewing trousers legs and other small areas such as children's garments.

Pull the flat bed extension cover to the left to remove it.

To attach it again, place it around the free arm and push it back to the right, until it clicks in place.

Note: The flat bed extension cover must also be removed to attach the extension table.

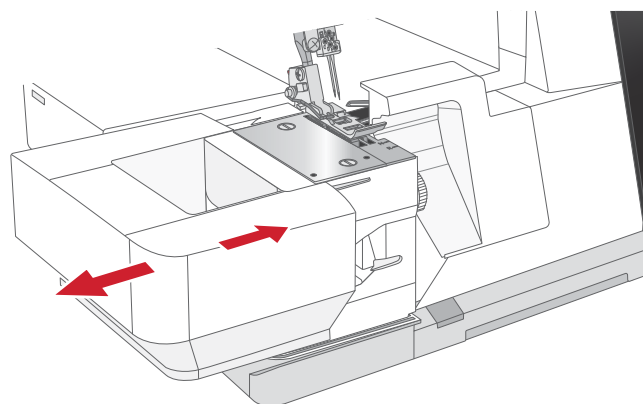

Change Between Cutter Cover A and Coverstitch Table B

For coverstitch and chainstitch sewing Coverstitch Table B should be used. You can easily change between Cutter Cover A (mounted upon delivery) and Coverstitch Table B.

Open the front cover.

Push the release lever (A) down and pull Cutter Cover A towards you to remove it.

Place Coverstitch Table B underneath the front lid. Slide the release lever, from above, into the slot in the front cover (B). Fit the two pins (C) of Coverstitch Table B, from underneath, into the holes (D) of the cover.

Push towards the front cover until the release lever clicks in place into the slot on the front cover (E).

Note: Whether you are using Cutter Cover A or Coverstitch Table B, they are attached and removed in the same way.

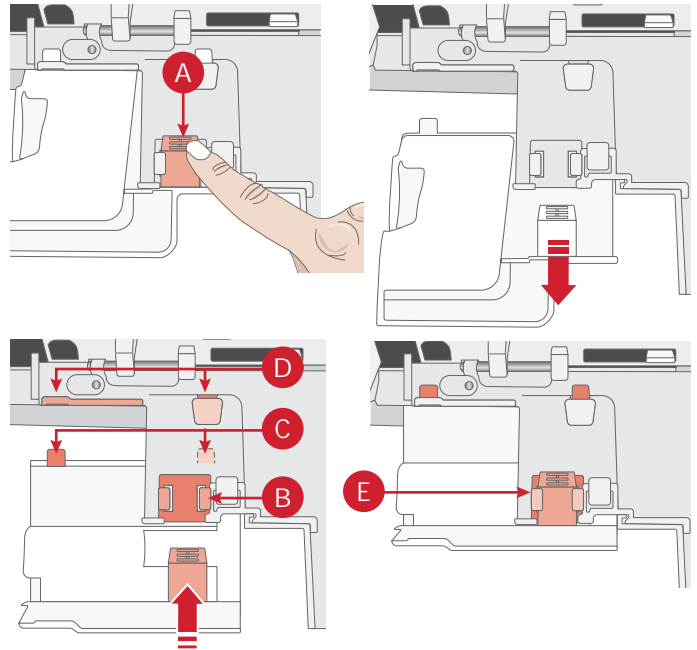

Presser Foot Lift

Raise the presser foot by raising the presser foot lifter (A) at the right side of the machine. Pressing the lifter up puts the presser foot in extra lift position.

Always raise the presser foot lifter when threading. When raised, the tension disks open and the threading becomes easier.

Note: The machine will not sew if the presser foot is raised. Lower the presser foot before starting to sew.

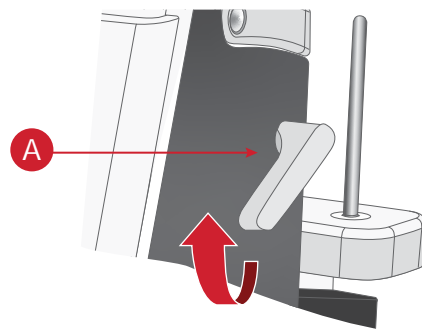

Change the Presser Foot

 Turn off the main power switch and unplug the machine.

Raise the presser foot.

Turn the handwheel toward you until the needles are at the highest position.

Push the red button (A) on the back of the presser foot ankle to release the presser foot.

Raise the presser foot to the extra lift position and the foot will come off.

Place the new foot with the pin right underneath the groove of the ankle while in the extra lift position (B). Lower the presser foot and the foot will snap in place.

Tip: If you find it difficult to snap on the presser foot, push the red button on the back of the ankle when lowering the foot (C).

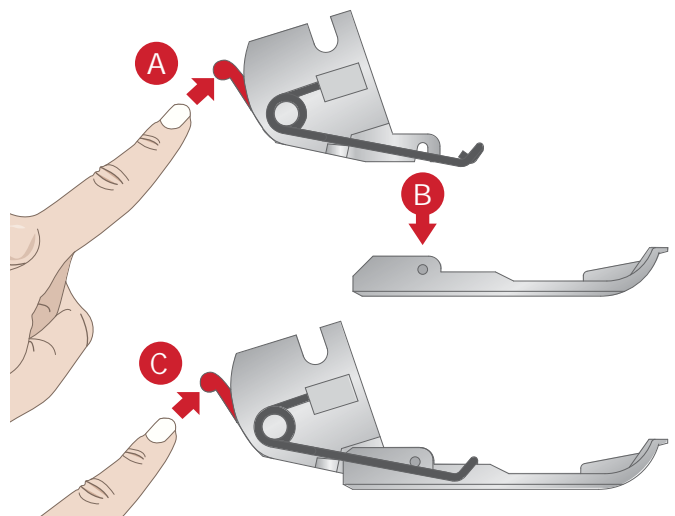

Needle Information

This overlock uses a flat shank industrial needle that eliminates the possibility of inserting the needle backwards.

Do not attempt to use a standard household sewing machine needle of any size or type in this overlock.

Use PFAFF® needles EL x 705 sizes 14/90 and 12/80, supplied with this machine.

You can sew using one, two or three needles depending on what stitch to use.

Note: When using two needles, the left needle is positioned a little higher up than the right needle (they are not supposed to be 'level', like a twin needle).

Checking the Needles

To make sure the needle is not bent, place the flat side of the needle onto something flat (needle plate, glass etc.). The gap between the needle and the flat surface should be consistent. Never use a bent or blunt needle.

Change the Needles

 Turn off the main power switch and unplug the machine.



Change the needle often. As a general rule, needles should be changed every 6-8 hours of actual stitching time.

Turn the handwheel toward you until the needles are at the highest position.

Place a thick piece of fabric under the presser foot. Lower the needles halfway into the fabric.

Loosen, but do not remove the needle clamp screw with the allen key while you are holding the needles.

Remove the selected needle.

Hold the new needle with the flat surface to the back.

Insert the needle into the needle clamp as far as it will go.

Note: We recommend using the hole in the needle threader to hold the needle.

Securely tighten the needle clamp screw using the allen key.

Note: Do not over-tighten the screw as this may cause the needle clamp to be damaged.

Note: When using only one needle, slightly tighten the other needle clamp screws. This is to prevent losing the needle clamp screw.

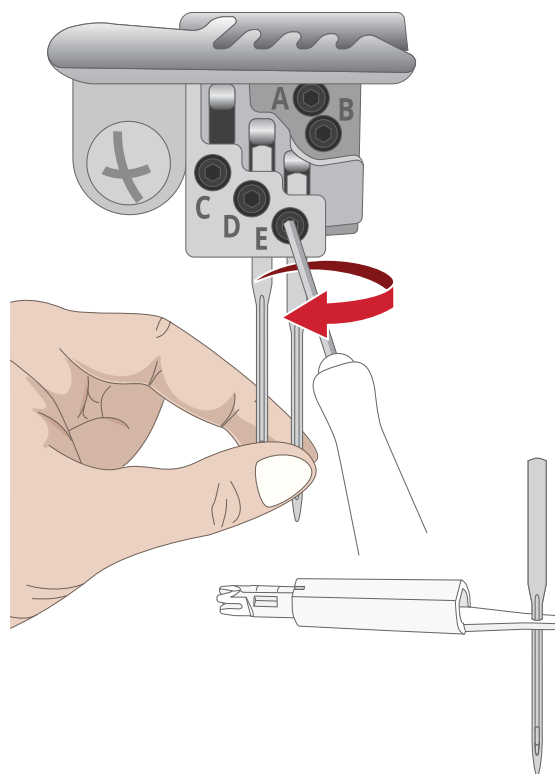

Upper Cutter Position

 Turn off the main power switch and unplug the machine.

Deactivate the Upper Cutter, Position B

Deactivate the upper cutter for flatlock, coverstitch and chainstitch or other sewing where the fabric shall not be cut.

Open the front cover.

Turn the handwheel toward you until the upper cutter (A) is raised to the highest position.

Pull the upper cutter knob (B) to the right as far as it will go.

Turn the knob towards you, until the cutter clicks into the locked position B (C).

Activate the Upper Cutter, Position A

Open the front cover.

Pull the movable cutter knob to the right as far as it will go.

Turn the knob towards you, until the cutter clicks into the cutting position A (D).

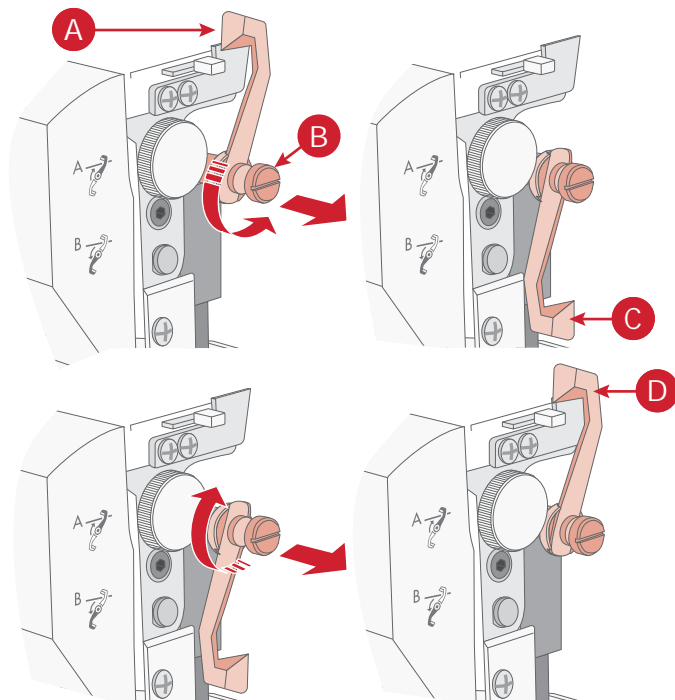

2-Thread Overlock Converter

2-thread overlock stitches are sewn using one needle thread and the lower looper thread. Before sewing, the 2-thread converter must be attached to the upper looper.

The 3-thread stretch overlock stitch is also sewn with the 2-thread overlock converter engaged.

 Turn off the main power switch and unplug the machine

Engage the 2-Thread Overlock Converter

Open the front cover.

Flip the 2-thread converter (A) to the left over the upper looper. Push the tip of the converter backwards carefully, and insert the sharp edge (B) of the converter in the eye (C) at the rear of the upper looper.

Disengage the 2-Thread Overlock Converter

Carefully push the 2-thread converter backwards and remove the sharp edge from the eye of the upper looper. Flip the converter to the right until it is in the disengaged position.

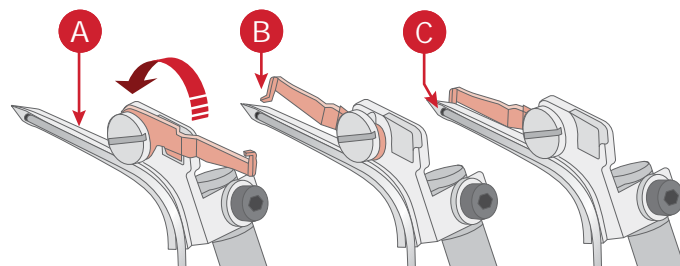

Upper Looper Position

Deactivate the upper looper for coverstitch and chainstitch sewing.

Deactivate the Upper Looper, Position B

Open the front cover.

Turn the handwheel until the upper looper is in its lowest position.

Slide the Upper Looper Positioning lever to the left to deactivate the upper looper, Position B (1).

Activate the Upper Looper, Position A

Open the front cover.

Slide the lever to the right to activate the upper looper, Position A (2).

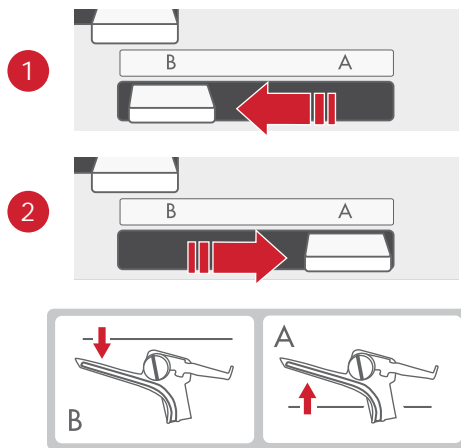

Threading/Sewing Lever

Threading Position

Before threading, the machine should be set in threading position. Then the needles, loopers and looper pipes are set in the correct position for threading.

Raise the presser foot to release the tension discs.

Set the Threading/Sewing lever in "Threading" position by sliding it to the left.

Turn the handwheel slowly toward you until it clicks and the needles/loopers are locked in threading position.

Thread the needles (page 23) and loopers (page 30) as described in respective section.

Sewing Position

When the threading is complete, the machine should be set in sewing position.

Set the Threading/Sewing lever in "Sewing" position by sliding it to the right.

Pull 4" (10 cm) of the thread under the toe of the foot, and back between the presser foot and the upper cutter.

Close the front cover and lower the presser foot.



Threading Position

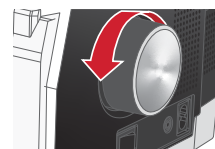

Turn the handwheel toward you



Sewing Position

Stitch Finger Lever

The stitch finger (A) is used to stabilize the fabric edge when forming stitches. The stitch finger lever should be set to "N" for all standard overlock sewing (B). To sew rolled edge you need to retract the stitch finger by setting the stitch finger lever to "R" (C).

When moving the stitch finger lever, be sure to push the lever as far as it will go in each direction.

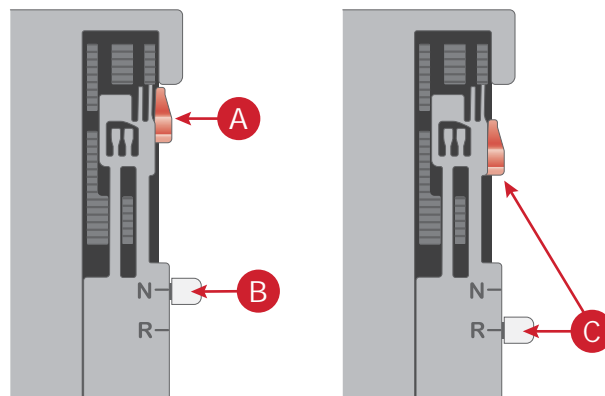

3 Touch Screen

Touch Screen Overview

Sewing mode is the first view on the Touch Screen after you turn on the machine. Your selected stitch will be shown in the stitch field. Here you will find all the basic information and recommendations you need to start sewing. This is also the menu where you adjust the settings of your stitch.

Note: When a setting is adjusted, the value will be highlighted.

1. Stitch selection drop down menu
2. Stitch field
3. Needle size
4. Needle position
5. Speed setting
6. Differential feed adjustment
7. Stitch length adjustment
8. Thread tension (touch to open the thread tension menu, where set values are viewed and adjusted)
9. Cutting width

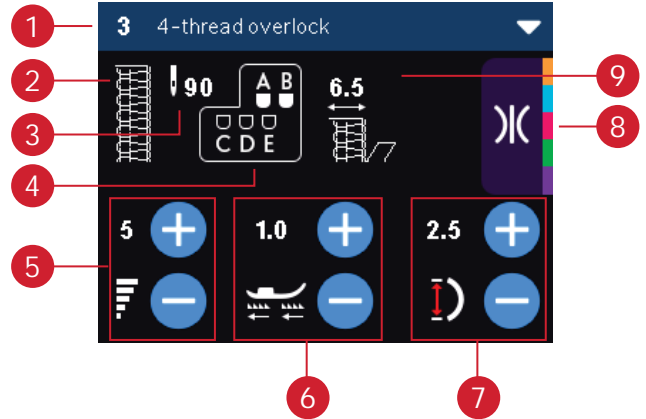

Select a Stitch

1. Touch the arrow to the right in the stitch selection drop down menu to open a list of stitches.
2. Use the scroll bar arrows to scroll in the list.
3. Touch a stitch in the list to select it.

When turning on the machine, the last sewn stitch is selected (the first time you turn the machine on, a 4-thread overlock is selected).



Stitch Recommendations

Recommendations for needle position, cutting width and presser foot pressure are always visible in the Sewing mode view. When a stitch is selected, a pop-up with extended recommendations is displayed. Touch Cancel (A) to close the pop-up.

1. Upper cutter position A/B
2. Use Cutter Cover A or Coverstitch Table B
3. Stitch finger lever setting
4. Presser foot pressure
5. Upper looper setting, Position A/B
6. Use 2-thread converter

The extended recommendations for the selected stitch can also be found in the Info System view, i1, see page 17.

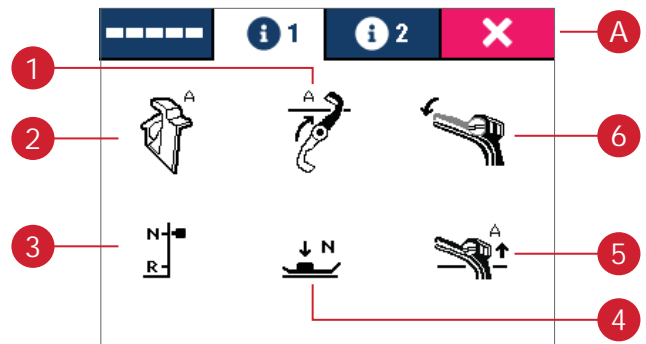

Info System

Recommendations for needle position and cutting width are always visible in the Sewing mode view. When a stitch is selected, a pop-up with extended recommendations is displayed. This information can also be accessed by pressing the Info button (A).

The info system consists of three tabs, the opening tab shows an image of the stitch and what threading paths to use (B). The second tab, i1, shows extended information on how to set up your machine (C). On tab i2, you find information on what the stitch can be used for, but also what fabric types that are recommended for that particular stitch (D).

Touch the Info button again to close.

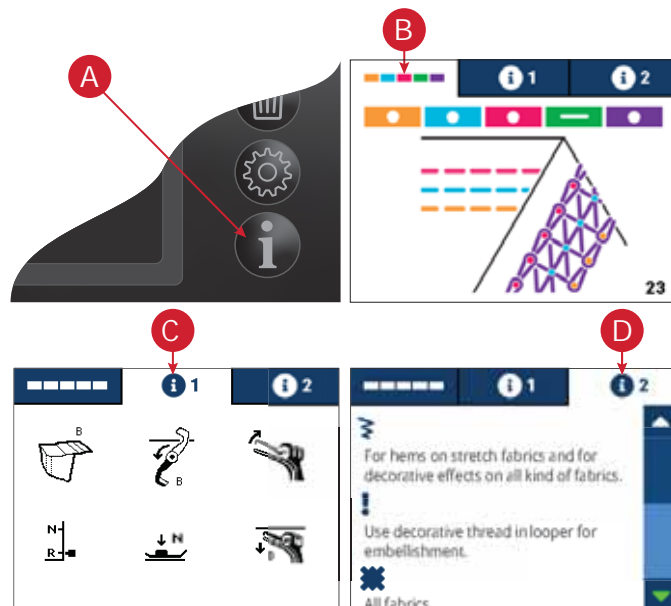

On-Screen Stitch Adjustments

Your machine will set the best settings for each selected stitch. You can make your own adjustments on the selected stitch.

The setting changes only affect the selected stitch. Your changed settings will be reset to default when selecting another stitch. The changed settings are not automatically saved when turning your machine off.

Thread Tension

Touch the thread tension icon (A) to open a thread tension adjustment window where the tension for each of the five threads is displayed. Touch the value number (B) for a thread to select it. The value number becomes surrounded by a colored background, indicating that it is selected. Touch - or + to adjust the thread tension for the selected thread. The value number becomes highlighted, showing that the standard setting has been changed (C).

Touch the thread tension icon to close the adjustment window.

Note: See page 50 for an overview of tension adjustments for each stitch type.

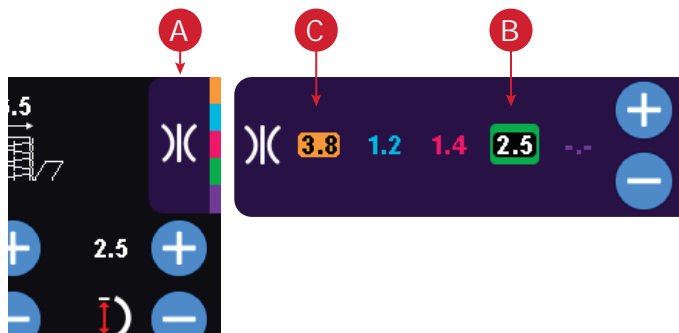

Differential Feed

To adjust the differential feed, touch + or -. The value number becomes highlighted, indicating that the standard setting has been changed.

Note: See for more instructions on adjusting the differential feed.



Stitch Length

To adjust the stitch length, touch + or -. The value number becomes highlighted, indicating that the standard setting has been changed.

Note: See for more instructions on adjusting the stitch length.

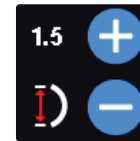

Sewing Speed

To adjust the default speed, touch + or -. The value number becomes highlighted, indicating that the standard setting has been changed.



Save a Stitch

To save the adjusted stitch, touch the Save Stitch button (A). You can save up to 30 different stitches. You can scroll through the list to find a free position, using the arrows. Any position without a stitch is free and can be used to save your new stitch. Touch a free position (B) and then OK (C) to save your stitch. The stitch information appears in the selected position.

Touch Cancel (D) to close the saving window and return to the Sewing mode view.

Any position with a stitch occupied. You can overwrite a previously stored stitch. Simply touch the stitch to overwrite. A pop-up will ask you to confirm that you want to overwrite the previously stored stitch. The stitch information appears in the selected position.

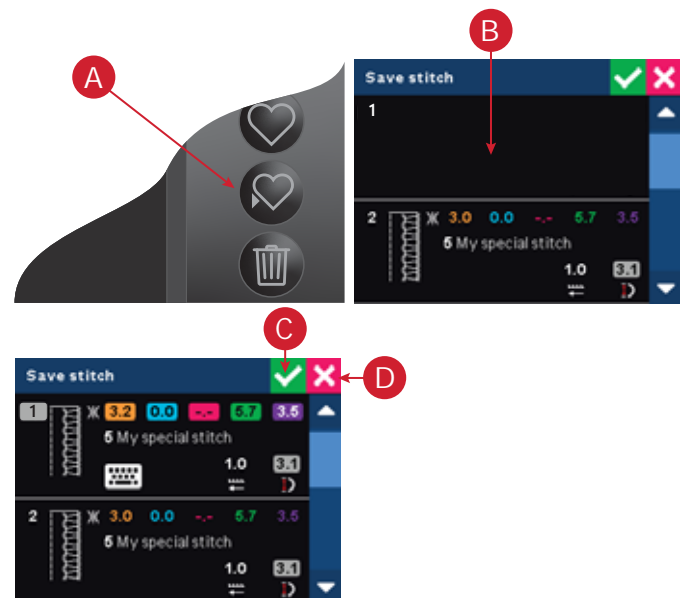

Personal Name

When a stitch is saved, it keeps the original stitch name. To give your saved stitch a new personal name, touch the keyboard icon (A) to open up a window for entering a personal name.

Touch the letters on the keyboard to enter your name. Touch the erase icon (B) to delete an entered character. Touch "Aa1" (C) to change between uppercase letters, lowercase letters and numbers. Touch OK (D) to confirm the new name, or Cancel (E) to cancel and keep the old name.

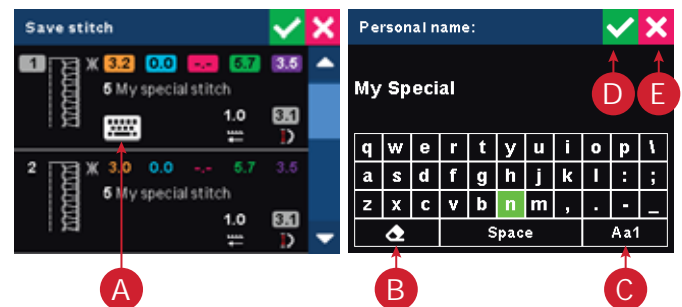

Delete a Saved Stitch

To delete a saved stitch, use the scroll bar arrows to step through the list. The highlighted stitch number (A) shows which stitch is selected. Touch the Delete button (B). A pop-up will ask you to confirm the deletion.

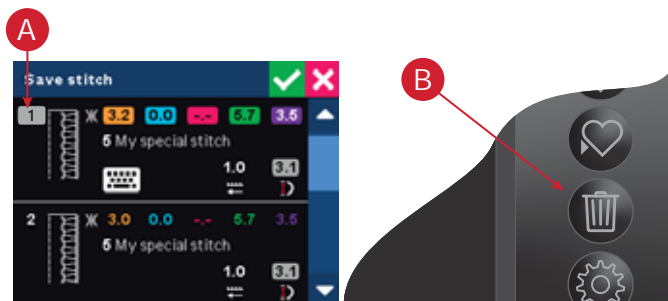

Load a Stitch

To load a previously saved stitch, touch the Load button (A).

Use the scroll bar arrows to scroll in the list. Touch a stitch in the list to select it, or touch Cancel to return to Sewing mode view.

When a stitch is selected, a pop-up message with detailed information about the stitch appears. Touch OK (B) to load the selected stitch or Cancel (C) to return to the Load Stitch list.

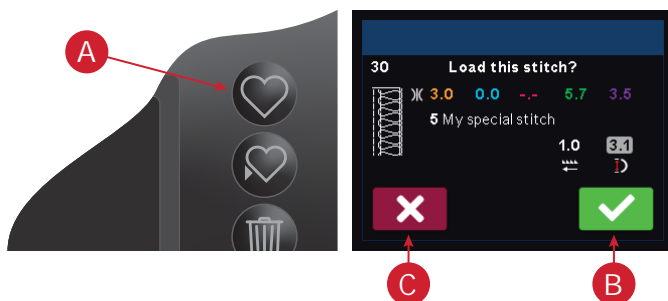

Settings Menu

Touch the Settings button (A) to open the settings menu. Here you can adjust the machine settings. Touch the Settings button again to close the settings menu and save the changes in the machine memory.

The changes in settings are saved after turning off the machine.

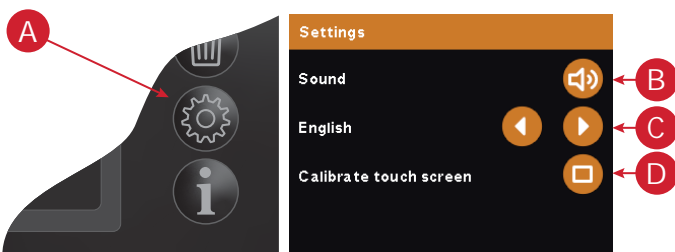

Sound

Turn the sound on and off by touching the speaker icon. A crossed-out speaker indicates that the sound is off.

Language

Step through the available languages used on screen by touching the arrows. The language description changes for each touch.

B. Sound

C. Language

D. Calibrate Touch Screen

Calibrate Touch Screen

When touching the icons on the screen, the screen might need a calibration to adjust to your touch. Touch the calibrate icon to open a special screen for touch screen calibration. With your stylus, first touch the center of the cross in the top left corner of the screen. The cross changes color and a new cross appears. Continue touching the center of the crosses that appear. The calibration screen closes automatically when you have touched all calibration crosses.

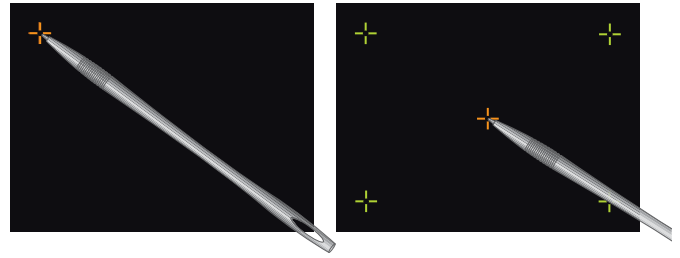

Note: If you cannot enter calibration mode through the settings menu, press and hold the Info button while starting the machine. Calibration mode opens and calibration can be performed.

Pop-Ups

When needed, your machine can alert you, by showing pop-up windows on the screen. The pop-up messages and explanations are found below.

Front Cover Open

As a safety precaution you cannot sew with the front cover open. The pop-up will close when the front cover is closed.

Warning, Overloaded, Please Wait

If you are sewing on very heavy fabric or if the machine is blocked when sewing, the main motor can get overloaded and the machine will stop sewing. The pop-up will close when the main motor and power supply are secure.

Presser Foot is Up

You cannot start sewing with the presser foot up. The pop-up will close when the presser foot is lowered.

Please Raise the Presser Foot to Calibrate

The presser foot must be raised when turning on the machine. The pop-up will close when the presser foot is raised.

4 Threading

General Threading Information

Inside the front cover, there is a chart showing how to thread the loopers (A) but also a stitch overview (B).

The threading paths are color coded, to make the threading easier. Always start threading from left to right. See the Stitch Overview, page 34, for a detailed description of what threading paths and settings to use for each stitch.

When a stitch is selected, you can also find necessary information on threading paths and settings on the info tabs on the display.

Your machine is equipped with an "Air Threading System" for fast, easy threading of the upper, lower, and chain loopers.

All three loopers can be threaded at the same time, with one push on the "threading button". The loopers are threaded automatically.

Even if the loopers can be threaded at the same time, the threading descriptions on the following pages will show the threading of the loopers separately.

Note: Always raise the presser foot before threading.

See the table below for recommendations on what needles and thread to use for different fabric weights.

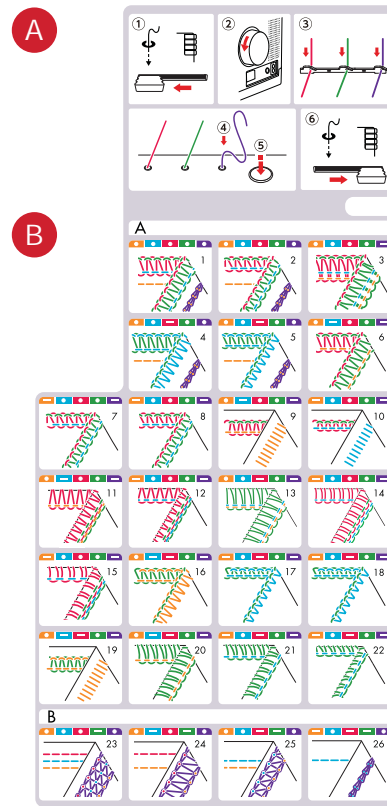

What Needle and Thread to Use

Fabric	<i>Light Fabric</i> (voile, crepe, georgette, etc.)	<i>Medium Fabric</i> (cotton, linen, chino, wool, satin, etc.)	<i>Heavy Fabric</i> (denim, tweed, etc.)	<i>Knits</i> Knitted fabrics
Needles	PFAFF® EL x 705 size #12/80	PFAFF® EL x 705 size #14/90	PFAFF® EL x 705 size #14/90	PFAFF® EL x 705 size #12/80 - #14/90
Thread	Polyester (spun filament) Twisted thread: #60/2 - #100/3 #80/3 - #100/3	Twisted thread: #60/2	Twisted thread: #50/2 - #60/2	Twisted thread: #50/2 - #60/2

Placing the Thread Spools on the Spool Pins

Place the thread spools over the cone holders on the spool pin. Firmly insert the spool holder into the spool.

Note: If the spools are very large, place the cone holders up-side-down on the spool pin.

- A. If sewing with small thread spools, remove the cone holders. Place the spool with its slit side up, and put the spool cap on top of it.
- B. If the thread slips down from the spool during threading and/or sewing, put a net over the spool to avoid thread jams.

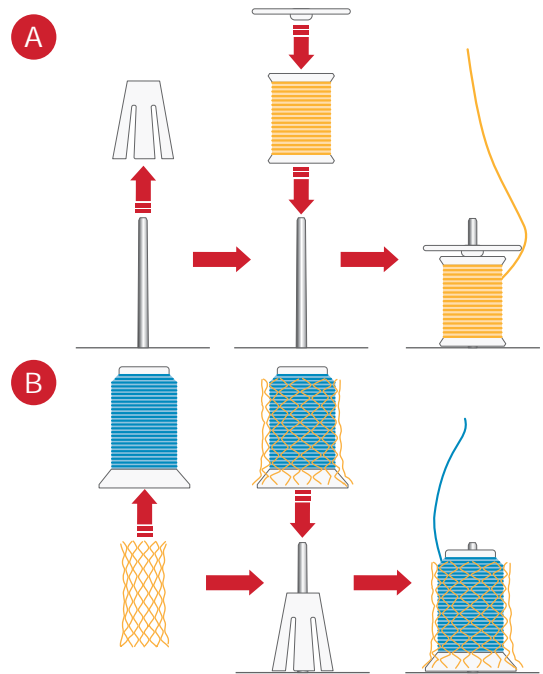

Changing Thread

To change the threads, re-thread the needles as described in section *Threading the Needles*, page 23, and the loopers using the air threading system as described in section *Threading the Loopers*, page 30.

The following is another easy way to change threads:

Cut the thread near the spool, behind the guides on the telescopic thread stand.

Remove the thread spool and place the new thread on the spool pin.

Tie the end of the new thread to the end of the old thread. Cut the thread tails to approx. 1" (2-3cm) in length and firmly pull both threads to test knot security.

Raise the presser foot, to release the thread tension.

Pull the threads through the machine one at a time until the knots are in front of the needle. If the threads cannot be pulled easily, check for tangles on thread guides or looping under thread stand.

Tip: By turning the handwheel a least a turn away from you, and pulling the threads straight backwards, you might find it easier to pull through the threads.

Cut the thread behind the knot and thread the needle.

Note: Do not use this method for heavy weight threads, instead thread according to recommendations on page 33

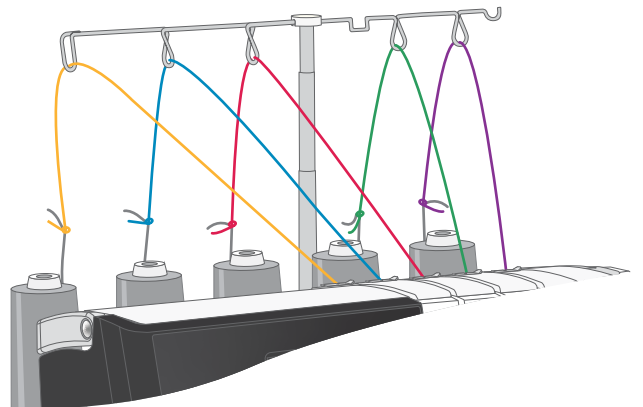

Threading the Needles

Threading the Left Overlock Needle (A)

- Yellow threading path
- Blue threading path for Safety Stitches no 1 and 4
- A/B Needle A
- C/D/E

Note: Raise the presser foot to release the tension discs.

Note: Make sure to raise the telescopic thread stand to its highest position (illustration shows a "cropped" thread stand).

1. Set the Threading/Sewing lever in "Threading" position by sliding it to the left.
Turn the handwheel slowly toward you until it clicks and the loopers are locked in threading position.
2. Place a thread spool on the left spool pin. Pull the thread through the left thread guide from back to front.
3. Carefully slide the thread under the pre-tension thread guide from right to left.
4. Pull the thread along the threading slit. Using both hands, insert the thread between the tension discs.
5. Pull the thread down along the slit and pass it to the left through the thread path.
6. Slip the thread into the middle slot on the thread guide.
7. Continue threading into the slot on the take-up lever.
8. Then slip the thread into the second slot on the next thread guide.
9. Place the thread in the third slot on the thread guide above the needle clamp.
10. Place the thread behind the guide above the A/B needles.
Thread the eye of the needle. Use the needle threader (see page 29) to make needle eye threading easier. Pull about 10 cm (4") of thread through needle eye to hang free.
Place the thread to the back, under the presser foot.
11. Set the Threading/Sewing lever in "Sewing" position by sliding it to the right.
Close the front cover and lower the presser foot to start sewing.

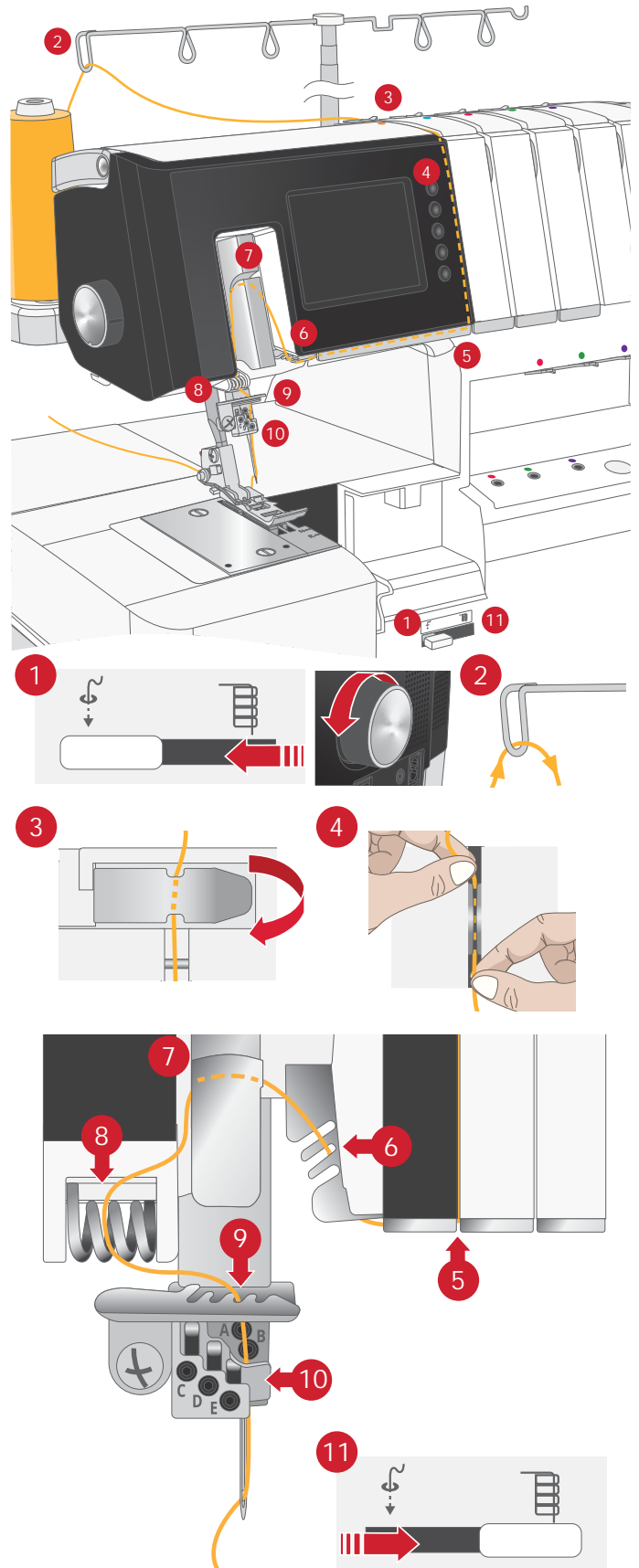

Threading the Right Overlock Needle (B)

 Blue threading path

 Needle B

Note: Raise the presser foot to release the tension discs.

Note: Make sure to raise the telescopic thread stand to its highest position (illustration shows a "cropped" thread stand).

1. Set the Threading/Sewing lever in "Threading" position by sliding it to the left.
Turn the handwheel slowly toward you until it clicks and the loopers are locked in threading position.
2. Place a thread spool on the second left spool pin.
Pull the thread through the second left thread guide from back to front.
3. Carefully slide the thread under the pre-tension thread guide from right to left.
4. Pull the thread along the threading slit. Using both hands, insert the thread between the tension discs.
5. Pull the thread down along the slit and pass it to the left following the thread path.
6. Slip the thread into the front slot on the thread guide.
7. Continue threading into the slot on the take-up lever.
8. Then slip the thread into the third slot on the next thread guide.
9. Place the thread in the fourth slot on the thread guide above the needle clamp.
10. Place the thread behind the guide above the A/B needles.

Thread the eye of the needle. Use the needle threader (see page 29) to make needle eye threading easier. Pull about 10 cm (4") of thread through needle eye to hang free.

Place the thread to the back, under the presser foot.

11. Set the Threading/Sewing lever in "Sewing" position by sliding it to the right.

Close the front cover and lower the presser foot to start sewing.

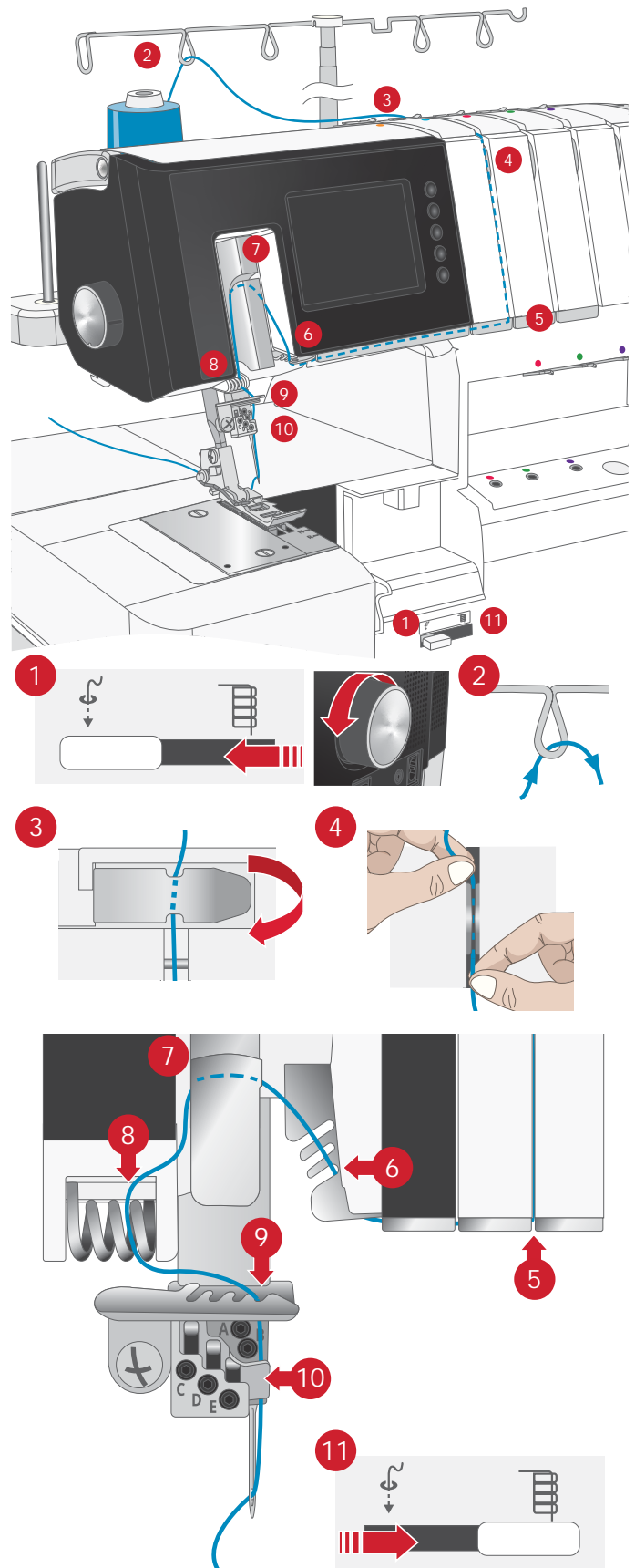

Threading the Chainstitch Needle (D)

● Blue threading path

● Yellow threading path for Safety Stitches no 1, 2, 4 and 5

 Needle D

Note: Raise the presser foot to release the tension discs.

Note: Make sure to raise the telescopic thread stand to its highest position (illustration shows a "cropped" thread stand).

1. Set the Threading/Sewing lever in "Threading" position by sliding it to the left.
Turn the handwheel slowly toward you until it clicks and the loopers are locked in threading position.
2. Place a thread spool on the second left spool pin. Pull the thread through the second left thread guide from back to front.
3. Carefully slide the thread under the pre-tension thread guide from right to left.
4. Pull the thread along the threading slit. Using both hands, insert the thread between the tension discs.
5. Pull the thread down along the slit and pass it to the left following the thread path.
6. Slip the thread into the middle slot on the thread guide.
7. Continue threading into the slot on the take-up lever.
8. Then slip the thread into the second slot on the next thread guide.
9. Place the thread in the second slot on the thread guide above the needle clamp.
Thread the eye of the needle. Use the needle threader (see page 29) to make needle eye threading easier. Pull about 10 cm (4") of thread through needle eye to hang free.
10. Set the Threading/Sewing lever in "Sewing" position by sliding it to the right.

Place the thread to the back, under the presser foot.
Close the front cover and lower the presser foot to start sewing.

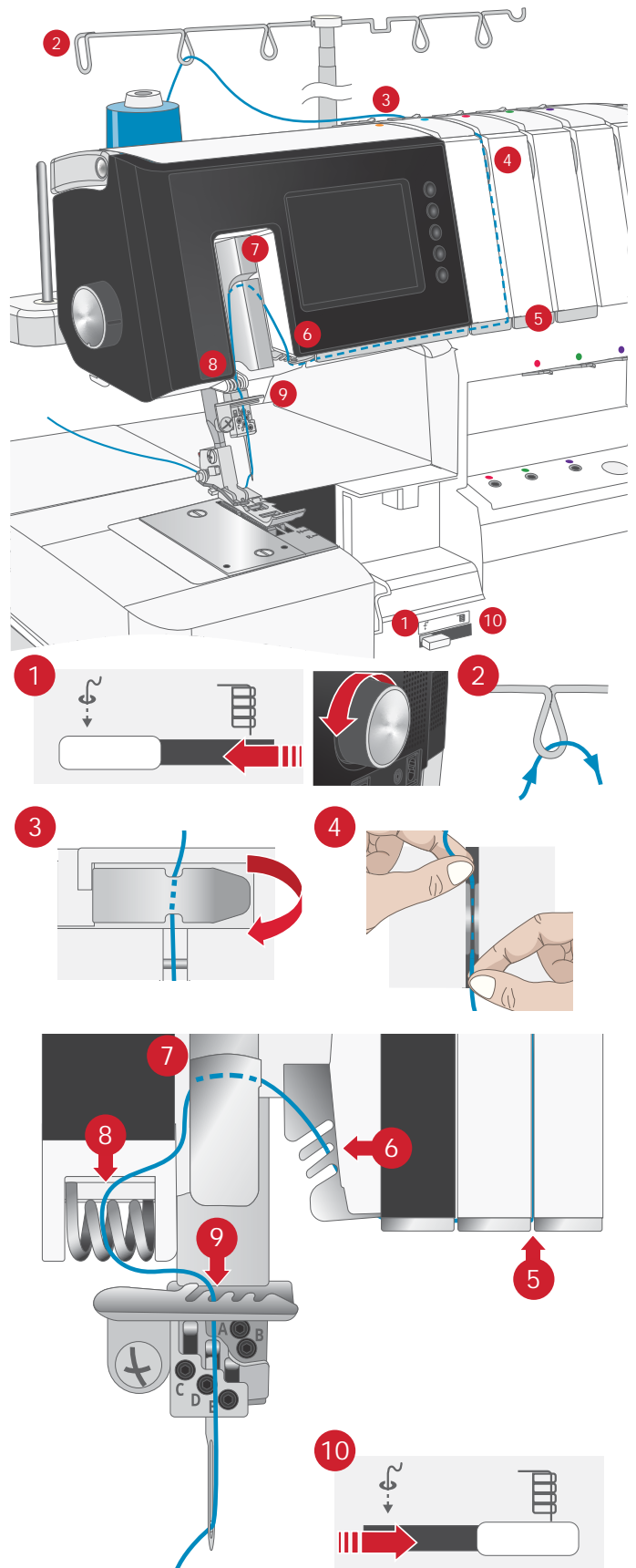

Threading the Coverstitch Needles

Note: Thread the needles in the following order: left (C), middle (D), right (E)

Threading the Left Coverstitch Needle (C)

 Yellow threading path

 Needle C

Note: Raise the presser foot to release the tension discs.

Note: Make sure to raise the telescopic thread stand to its highest position (illustration shows a "cropped" thread stand).

1. Set the Threading/Sewing lever in "Threading" position by sliding it to the left.
Turn the handwheel slowly toward you until it clicks and the loopers are locked in threading position.
2. Place a thread spool on the left spool pin. Pull the thread through the left thread guide from back to front.
3. Carefully slide the thread under the pre-tension thread guide from right to left.
4. Pull the thread along the threading slit. Using both hands, insert the thread between the tension discs.
5. Pull the thread down along the slit and pass it to the left following the thread path.
6. Slip the thread into the rear slot on the thread guide.
7. Continue threading into the slot on the take-up lever.
8. Then slip the thread into the first slot on the next thread guide.
9. Place the thread in the first slot on the thread guide above the needle clamp.
Thread the eye of the needle. Use the needle threader (see page 29) to make needle eye threading easier. Pull about 10 cm (4") of thread through needle eye to hang free.
- Place the thread to the back, under the presser foot.
10. Set the Threading/Sewing lever in "Sewing" position by sliding it to the right.
Close the front cover and lower the presser foot to start sewing.

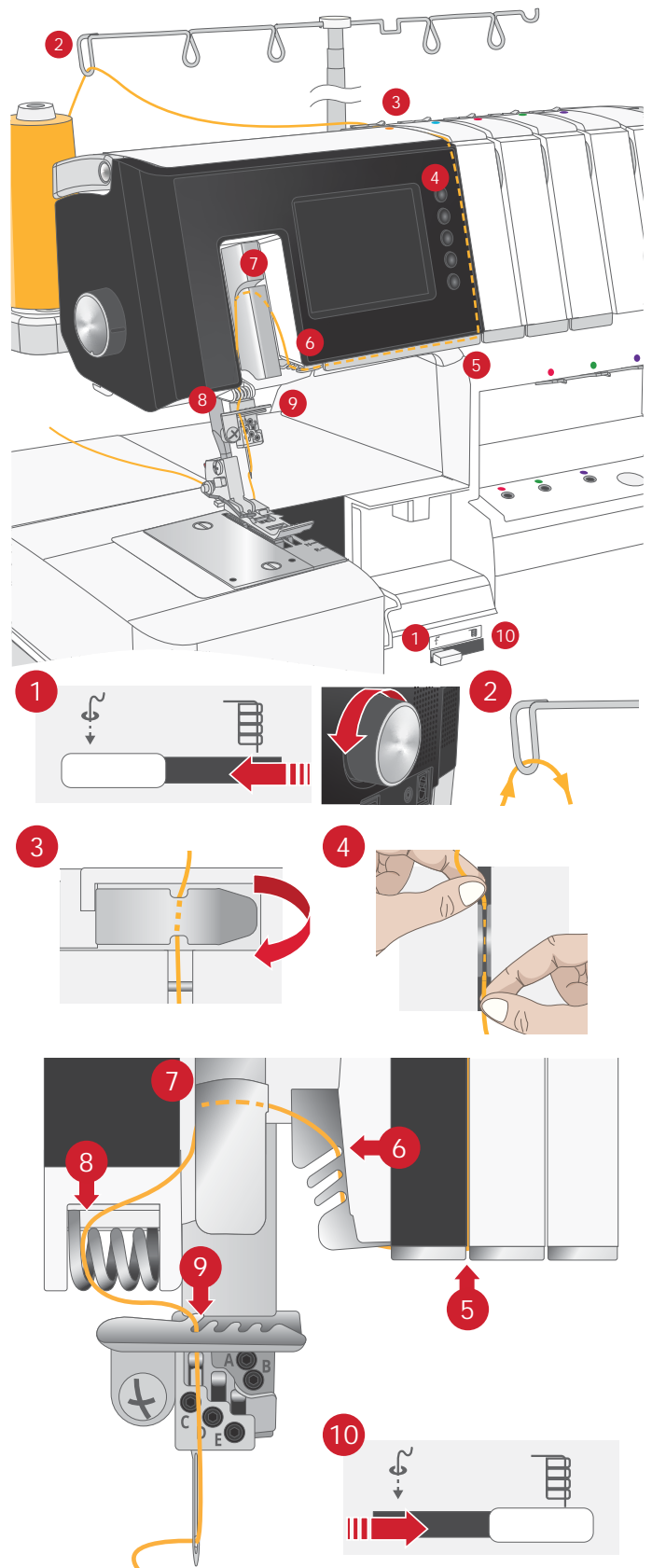

Threading the Middle Coverstitch Needle (D)

 Blue threading path

 Needle D

Note: Raise the presser foot to release the tension discs.

Note: Make sure to raise the telescopic thread stand to its highest position (illustration shows a "cropped" thread stand).

1. Set the Threading/Sewing lever in "Threading" position by sliding it to the left.
Turn the handwheel slowly toward you until it clicks and the loopers are locked in threading position.
 2. Place a thread spool on the second left spool pin. Pull the thread through the second left thread guide from back to front.
 3. Carefully slide the thread under the pre-tension thread guide from right to left.
 4. Pull the thread along the threading slit. Using both hands, insert the thread between the tension discs.
 5. Pull the thread down along the slit and pass it to the left following the thread path.
 6. Slip the thread into the middle slot on the thread guide.
 7. Continue threading into the slot on the take-up lever.
 8. Then slip the thread into the second slot on the next thread guide.
 9. Place the thread in the second slot on the thread guide above the needle clamp.
- Thread the eye of the needle. Use the needle threader (see page 29) to make needle eye threading easier. Pull about 10 cm (4") of thread through needle eye to hang free.
- Place the thread to the back, under the presser foot.
10. Set the Threading/Sewing lever in "Sewing" position by sliding it to the right.

Close the front cover and lower the presser foot to start sewing.

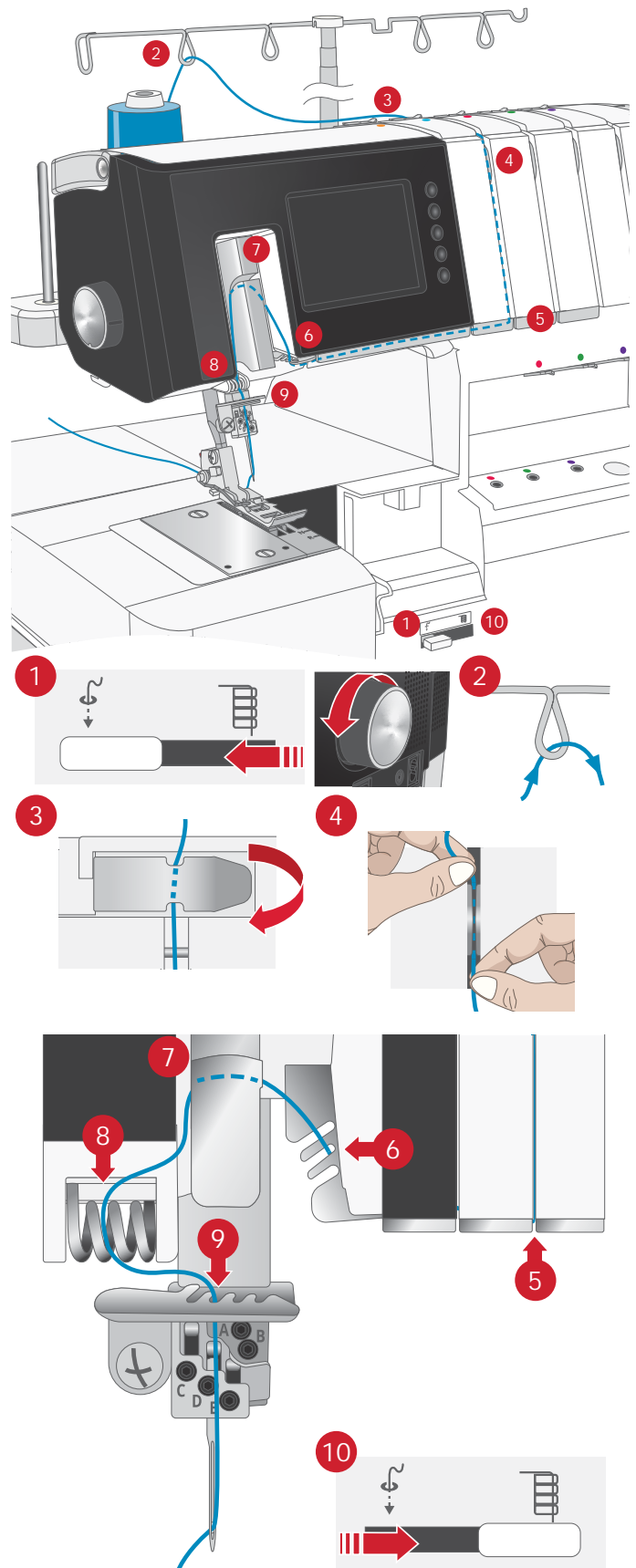

Threading the Right Coverstitch Needle (E)

● Red threading path

 Needle E

Note: Raise the presser foot to release the tension discs.

Note: Make sure to raise the telescopic thread stand to its highest position (illustration shows a "cropped" thread stand).

1. Set the Threading/Sewing lever in "Threading" position by sliding it to the left.
Turn the handwheel slowly toward you until it clicks and the loopers are locked in threading position.
2. Place a thread spool on the middle spool pin. Pull the thread through the left thread guide from back to front.
3. Carefully slide the thread under the pre-tension thread guide from right to left.
4. Pull the thread along the threading slit. Using both hands, insert the thread between the tension discs.
5. Pull the thread down along the slit and pass it to the left following the thread path.
6. Slip the thread into the front slot on the thread guide.
7. Continue threading into the slot on the take-up lever.
8. Then slip the thread into the third slot on the next thread guide.
9. Place the thread in the third slot on the thread guide above the needle clamp.
Thread the eye of the needle. Use the needle threader (see page 29) to make needle eye threading easier. Pull about 10 cm (4") of thread through needle eye to hang free.
- Place the thread to the back, under the presser foot.
10. Set the Threading/Sewing lever in "Sewing" position by sliding it to the right.
Close the front cover and lower the presser foot to start sewing.

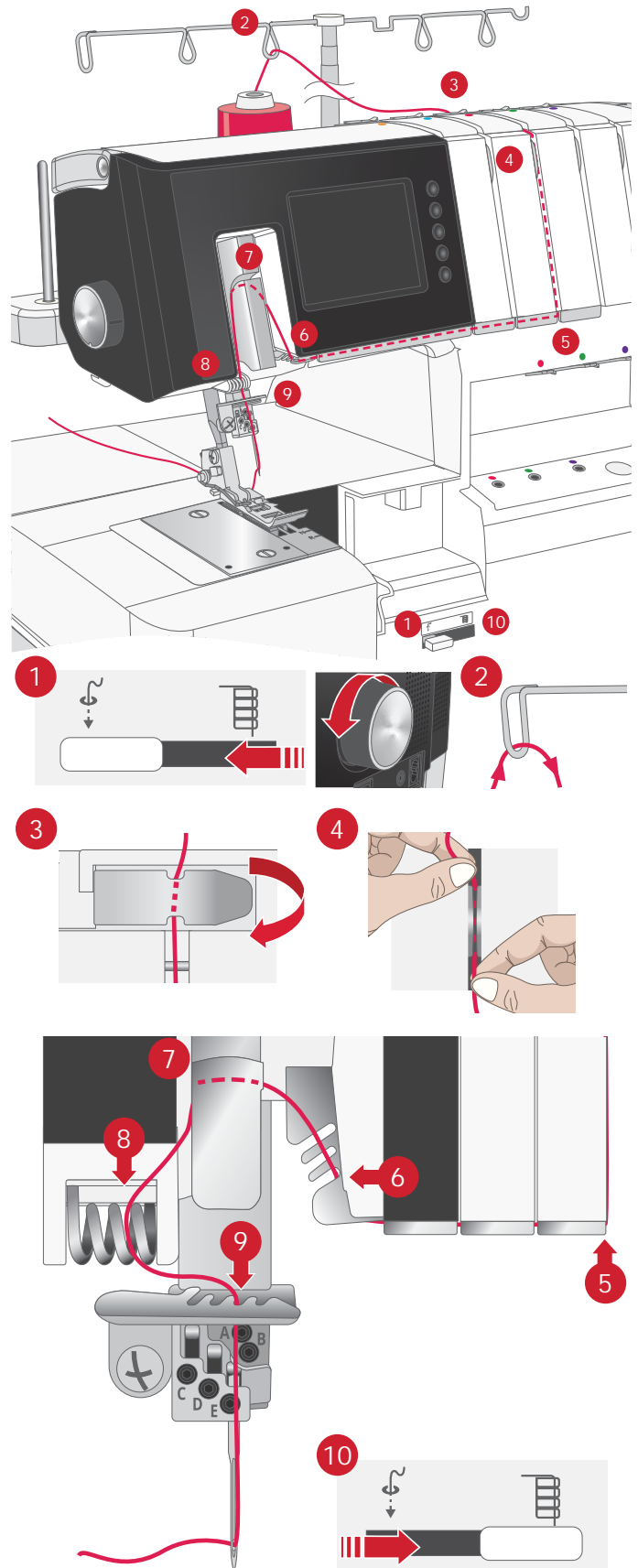

Needle Threader

To make threading the needles easier, use the needle threader included with the accessories.

Turn the handwheel so the needles are in their highest position and lower the presser foot. Make sure one of the rectangular markings of the needle threader is pointing upwards (A). Place the thread from right to left in the notch on the tip of the needle threader (B).

Hold the needle threader against the needle. Move the needle threader down to the needle eye and press gently against the needle, causing a small metal pin to push the thread through the needle eye and form a thread loop (C).

Use the needle threader to pull the thread loop out behind the needle (D).

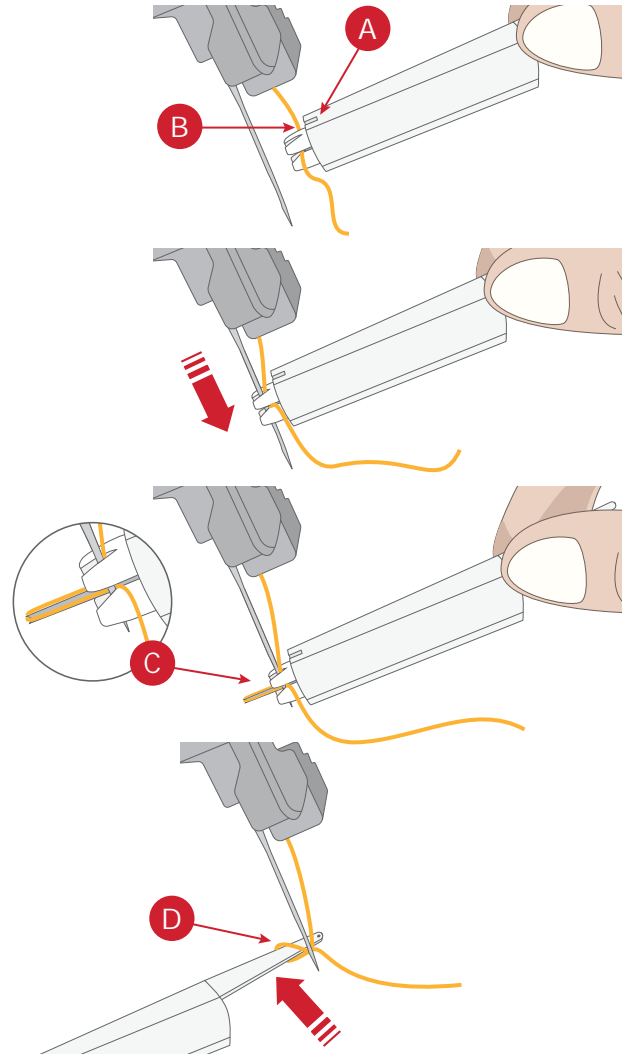

Threading the Loopers

Threading the Upper Looper

● Red threading path

Note: Raise the presser foot to release the tension discs.

Note: Make sure to raise the telescopic thread stand to its highest position (illustration shows a "cropped" thread stand).

Note: Make sure the upper looper is in up-position, by sliding the upper looper positioning lever to the right (page 15).

Note: If threading special threads, such as wooly nylon, etc., refer to page 33.

1. Set the Threading/Sewing lever in "Threading" position by sliding it to the left.
Turn the handwheel slowly toward you until it clicks and the loopers are locked in threading position.
2. Place a thread spool on the mid spool pin. Pull the thread through the mid thread guide from back to front.
3. Carefully slide the thread under the top cover thread guide from right to left, as illustrated.
4. Pull the thread along the threading slit. Using both hands, insert the thread between the tension discs.
5. Pull the thread down along the slit and into the upper looper thread guide.
6. Pull out approximately 22" (56 cm) of thread. Make sure that the thread does not get tangled around the cover. Using the tweezers, insert the end of the thread 2 cm or more into the upper looper threading hole.
7. Push the Threading Button to thread the looper.
8. Make sure that the thread comes out from the hole of the looper tip.
If the thread does not come out from the hole, follow the procedure from step "6" again.
Pull 4" (10 cm) of the thread under the toe of the foot, and back between the presser foot and the upper cutter.
9. Set the Threading/Sewing lever in "Sewing" position by sliding it to the right.

Close the front cover and lower the presser foot.

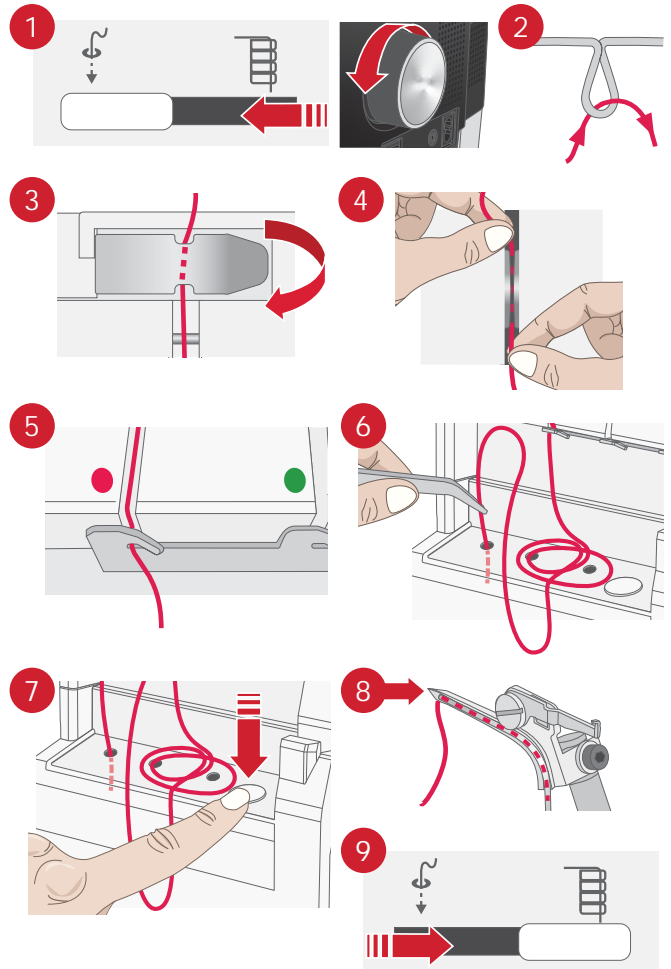
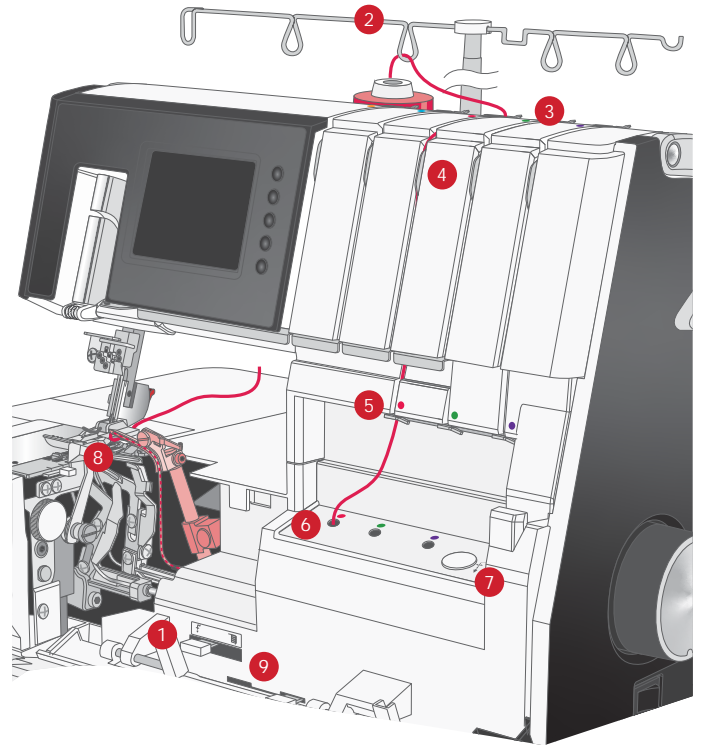

Threading the Lower Loooper

● Green threading path

Note: Make sure to raise the telescopic thread stand to its highest position (illustration shows a "cropped" thread stand).

Note: Raise the presser foot to release the tension discs.

Note: If threading special threads, such as wooly nylon, etc., refer to page 33.

1. Set the Threading/Sewing lever in "Threading" position by sliding it to the left.
Turn the handwheel slowly toward you until it clicks and the loopers are locked in threading position.
2. Place a thread spool on the second right spool pin. Pull the thread through the second right thread guide from back to front.
3. Carefully slide the thread under the top cover thread guide from right to left, as illustrated.
4. Pull the thread along the threading slit. Using both hands, insert the thread between the tension discs.
5. Pull the thread down along the slit and into the lower looper thread guide.
6. Pull out approximately 22" (56 cm) of thread. Make sure that the thread does not get tangled around the cover.

Using the tweezers, insert the end of the thread 2 cm or more into the lower looper threading hole.

Note: Trim the thread end so that it can be inserted into the threading hole smoothly.

7. Push the Threading Button to thread the looper.
8. Make sure that the thread comes out from the hole of the looper tip.
If the thread does not come out from the hole, follow the procedure from step "6" again.
Pull 4" (10 cm) of the thread under the toe of the foot, and back between the presser foot and the upper cutter.
9. Set the Threading/Sewing lever in "Sewing" position by sliding it to the right.

Close the front cover and lower the presser foot.

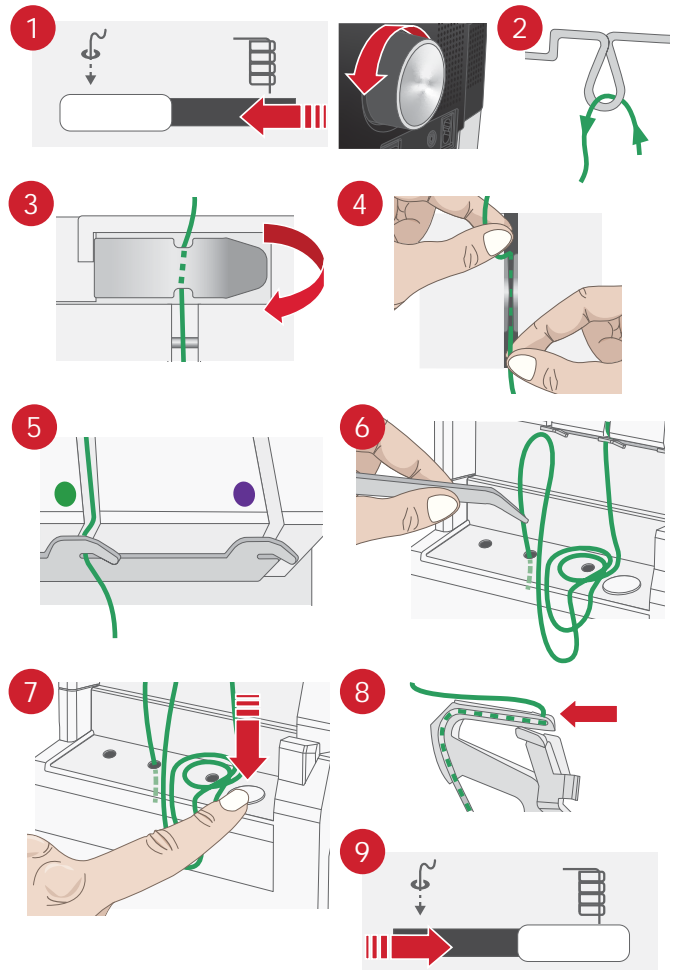
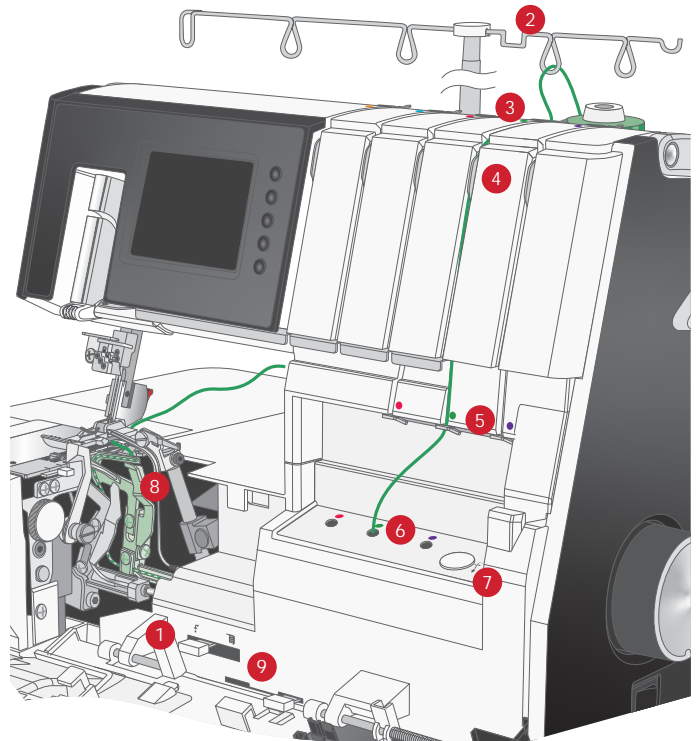

Threading the Chainstitch Looper

Purple threading path

Note: Make sure to raise the telescopic thread stand to its highest position (illustration shows a "cropped" thread stand).

Note: Raise the presser foot to release the tension discs.

Note: If threading special threads, such as wooly nylon, etc., refer to page 33.

1. Set the Threading/Sewing lever in "Threading" position by sliding it to the left.

Turn the handwheel slowly toward you until it clicks and the loopers are locked in threading position.

2. Place a thread spool on the right spool pin. Pull the thread through the right thread guide from back to front.
3. Carefully slide the thread under the top cover thread guide from right to left, as illustrated.
4. Pull the thread along the threading slit. Using both hands, insert the thread between the tension discs.
5. Pull the thread down along the slit and into the chainstitch looper thread guide.
6. Pull out approximately 22" (56 cm) of thread. Make sure that the thread does not get tangled around the cover.

Using the tweezers, insert the end of the thread 2 cm or more into the chainstitch looper threading hole.

Note: Trim the thread end so that it can be inserted into the threading hole smoothly.

7. Push the Threading Button to thread the looper.
8. Make sure that the thread comes out from the hole of the looper tip.

If the thread does not come out from the hole, follow the procedure from step "6" again.

Pull 4" (10 cm) of the thread, and place it in the looper cover.

9. Set the Threading/Sewing lever in "Sewing" position by sliding it to the left.

Close the front cover and lower the presser foot.

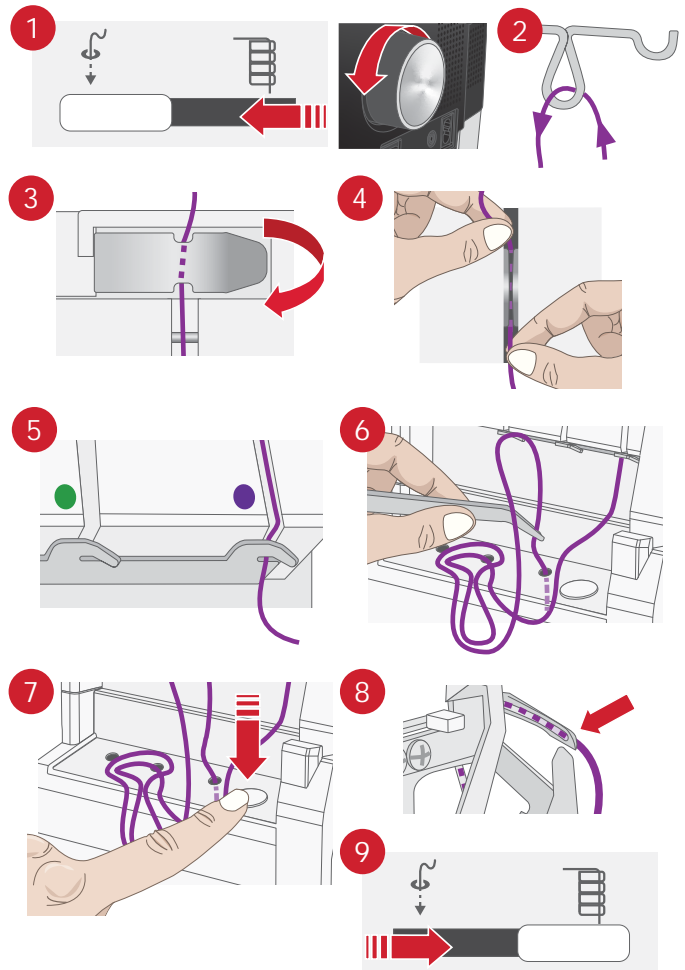
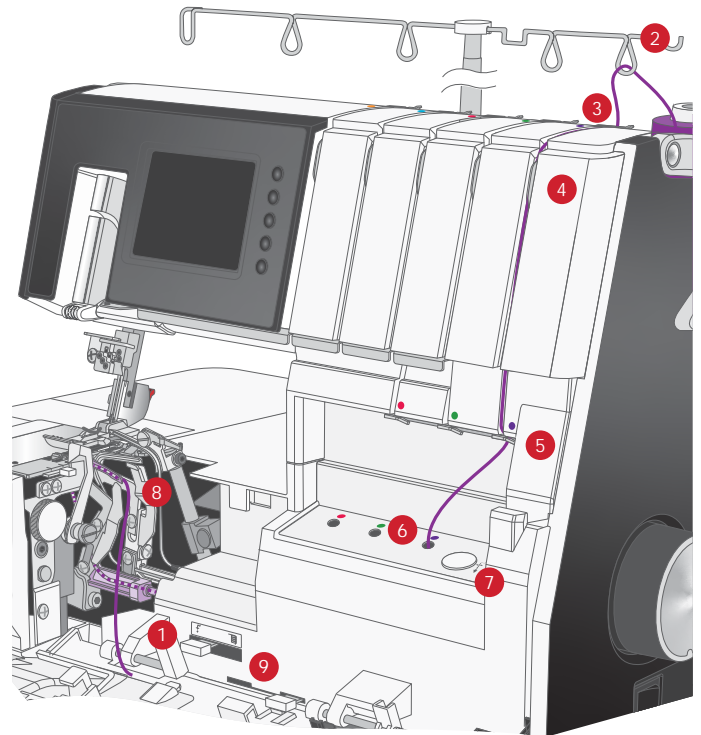

Threading Specialty Threads

When sewing with specialty threads (such as wooly nylon), it can be easier to thread the loopers using the looper threading wire or a standard overlock thread.

Before threading:

Note: Raise the presser foot to release the tension discs.

Set the Threading/Sewing lever in "Threading" position by sliding it to the left.

Turn the handwheel slowly toward you until it clicks and the loopers are locked in threading position.

Thread the looper threads up to the front of the looper threading hole.

Once the loopers are threaded:

Set the Threading/Sewing switch to "Sewing" position.

Pull 4" (10 cm) of the thread under the toe of the foot, and back between the presser foot and the upper cutter.

Close the front cover and lower the presser foot.

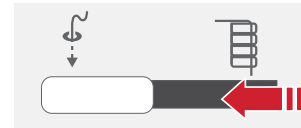

Threading Position

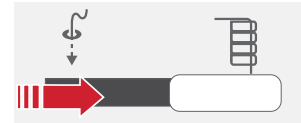

Sewing Position

Using the Looper Threading Wire

Note: Do not push the threading button when using the threading wire.

Take the looper threading wire and push the straight end (not the loop end) through the looper threader hole until it comes out from the hole of the looper tip (A).

Pass approximately 2" (5 cm) of thread through the loop of the looper threading wire (B).

Carefully pull the end of the looper threading wire until the thread comes out from the hole of the looper tip (C).

Remove the thread from the looper threading wire.

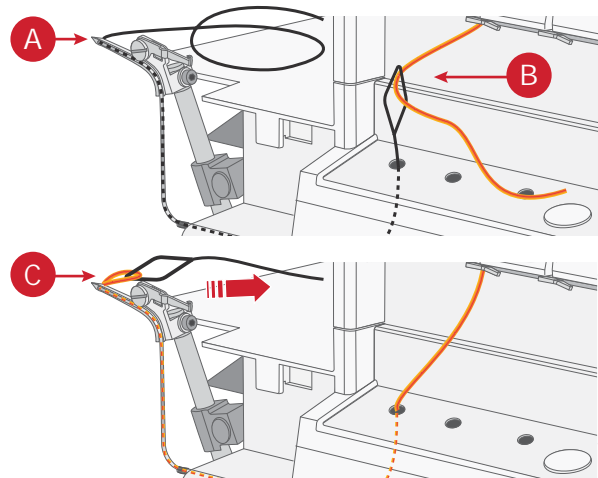

Using a Standard Thread

Prepare 12" (30 cm) of a standard thread and tie it 5 cm from the end of the looper thread as shown (A).

Note: When tying the standard thread to the looper thread, tie a knot as small as possible and cut any excess standard thread.

Using the tweezers, insert the end of the thread 2 cm or more into the looper threading hole (B).

Push the Threading Button to thread the looper (C).

Make sure that the thread comes out from the hole of the looper tip. Carefully pull the standard thread until the knot is about to go into the looper threader hole.

Then fold the loose end of the specialty thread as illustrated (D). Continue pulling the standard thread until the specialty thread is pulled through the threading channel and is threaded through the hole in the looper tip (E).

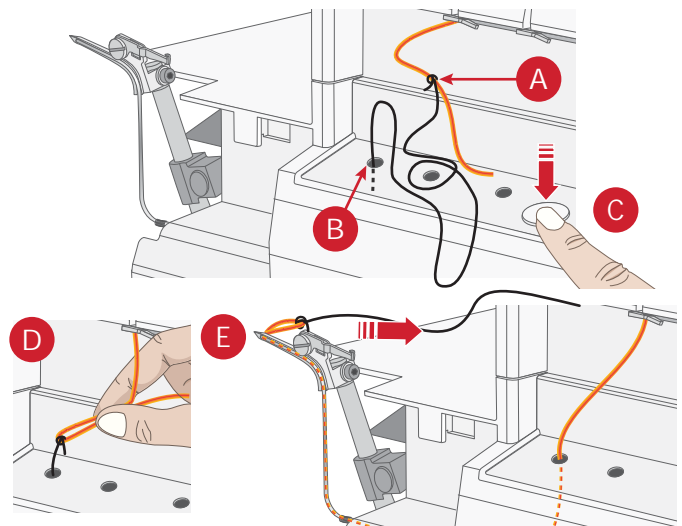

5 Stitches and Sewing Techniques

Stitch Overview

The settings shown in the stitch overview are our recommendations based on normal conditions. Each stitch has a pre-set stitch length and thread tension. It may be necessary to adjust the settings according to the stitch, type of fabric and thread you are using. For best results make adjustments in small steps of no greater than half a number at a time. Always test sew on a sample of your fabric before sewing on your project.

Different stitches are obtained by combining different needle positions, threading methods, and the use of the 2-thread converter.

Icon Explanation



Needle Position

N/R Stitch Finger Lever Setting



2-Thread Converter



Cutting Width

A/B A or B Setting
Position for Upper Cutter/Upper
Looper and usage of Cutter Cover A or
Coverstitch Table B



Threading Path
Color dots indicate what
threading paths that shall be
used

5-Thread Safety Stitch, Wide

For joining with a reinforced stitch and overcasting in one step. A durable chainstitch seam with overlock edge for garment sewing, quilt piecing and other projects.

			N/R		A/B	
	D, A	6.5	N	—	A	







5-Thread Safety Stitch, Narrow

For joining with a reinforced stitch and overcasting in one step. A durable chainstitch seam with overlock edge for garment sewing, quilt piecing and other projects.

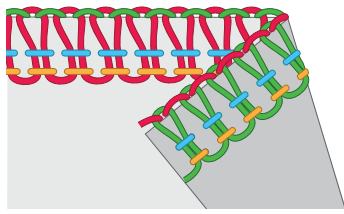
			N/R		A/B	
	D, B	6.5	N	—	A	







4-Thread Overlock

For all seams where stretch or give is needed, such as neck edges, side seams, sleeves, etc. Specialty techniques can be done with a 4-thread overlock seam such as gathering, applying piping with the optional piping foot and elastic with the optional elastic foot.

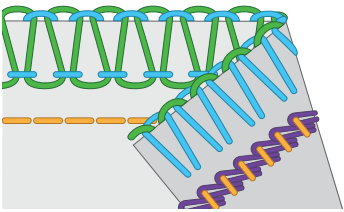
3				N/R		A/B	
		A, B	6.5	N	—	A	







4-Thread Safety Stitch, Wide

For joining with reinforced stitch and overcasting in one step.

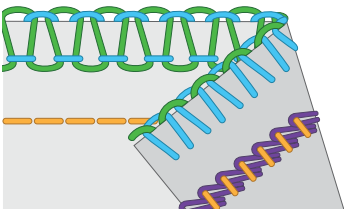
4				N/R		A/B	
		D, A	6.0	N	YES	A	







4-Thread Safety Stitch, Narrow

For joining with reinforced stitch and overcasting in one step.

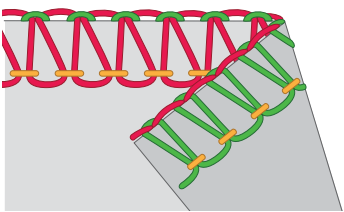
5				N/R		A/B	
		D, B	6.5	N	YES	A	







3-Thread Overlock, Wide

For sewing two layers of stretchy fabric or overcasting a single layer of light to medium fabric. Use heavier threads in the loopers to create decorative braids. (Hold your hand behind the presser foot and gently and slowly pull the thread chain as you sew, trying to keep the same tension as it has been sewn onto fabric.)

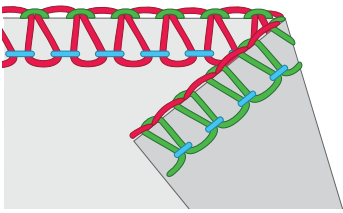
6				N/R		A/B	
		A	6.5	N	—	A	

3-Thread Overlock, Narrow







For sewing two layers of stretchy fabric or overcasting a single layer of light fabric. Popular for creating decorative tucks. Use decorative threads in the loopers and regular thread in the needle. Use different colors in the loopers to get an interesting effect.

7				N/R		A/B	
		B	6.5	N	—	A	

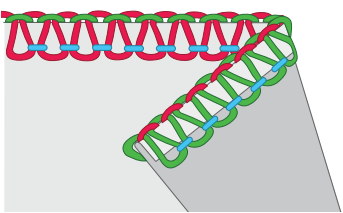
3-Thread Narrow Edge







For edging lightweight fabrics. It gives a nice finish on silky scarves, pillow ruffles and napkins. Thread the upper looper with a decorative thread, such as 40 weight rayon for a beautiful satin edge. Read more on page 43.

Note: Not recommended for heavyweight woven fabrics or medium to heavyweight stretch fabrics.

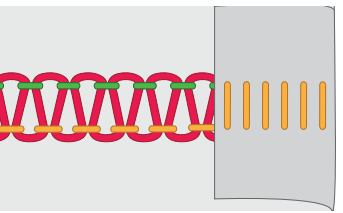
8				N/R		A/B	
		B	6.5	R	—	A	







3-Thread Flatlock, Wide

For sewing stretchy fabrics together with a decorative effect either with the flatlock side or the ladder stitch side. Create varying effects by threading the upper looper with decorative thread. Read more on page 44.

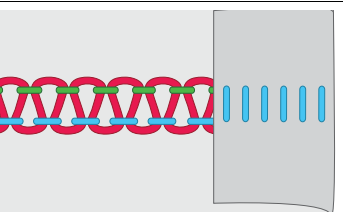
9				N/R		A/B	
		A	6.5	N	—	A	







3-Thread Flatlock, Narrow

For sewing stretchy fabrics together with a decorative effect either with the flatlock side or the ladder stitch side. Create varying effects by threading the upper looper with decorative thread. Read more on page 44.

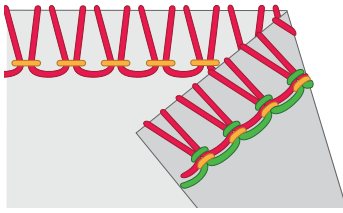
10				N/R		A/B	
		B	6.5	N	—	A	







3-Wrapped Overlock, Wide

For sewing two layers of stretchy fabrics together.

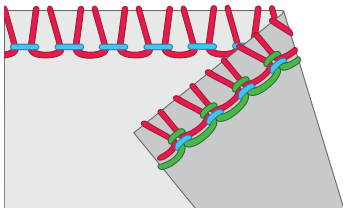
11				N/R		A/B	
		A	6.0	N	—	A	







3-Wrapped Overlock, Narrow

For sewing two layers of stretchy fabrics together.

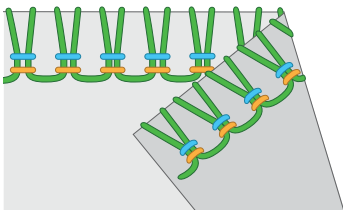
12				N/R		A/B	
		B	6.5	N	—	A	

3-Thread Stretch Overlock







For sewing extra stretchy fabrics. Add additional stretch by using a stretchy type thread in the lower looper. Change the thread tension accordingly.

13				N/R		A/B	
		A, B	6.5	N	YES	A	

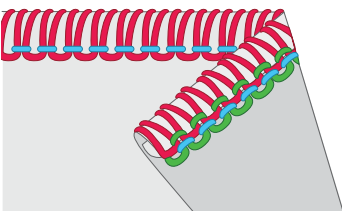
3-Thread Rolled Edge







For edging lightweight fabrics. It gives a nice finish on silky scarves, pillow ruffles and napkins. For a beautiful rolled edge, thread the upper looper with decorative thread and the needle and lower looper with lightweight regular thread. Read more on page 43.

Note: Not recommended for heavyweight woven fabrics or medium to heavyweight stretch fabrics.

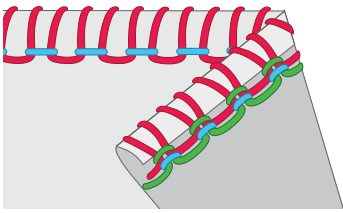
14				N/R		A/B	
		B	6.0	R	—	A	







3-Thread Picot Edge

Increased stitch length will form a picot edge on your fabric. This edge is a nice way to give a decorative finish to wedding or bridesmaid dresses.

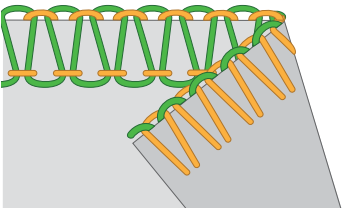
15				N/R		A/B	
		B	6.0	R	—	A	







2-Thread Overlock, Wide

For overcasting a single layer of light to medium weight fabrics.

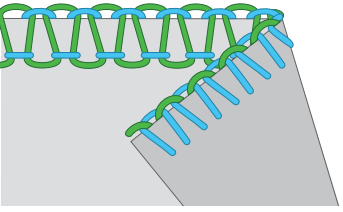
16				N/R		A/B	
		A	6.5	N	YES	A	

2-Thread Overlock, Narrow







For overcasting a single layer of light to medium weight fabrics.

17				N/R		A/B	
		B	6.5	N	YES	A	

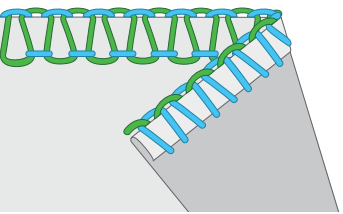
2-Thread Narrow Edge

Use for edging lightweight fabrics. Read more on page 43.

Note: Not recommended for heavyweight woven fabrics or medium to heavyweight stretch fabrics.

18				N/R		A/B	
		B	6.5	R	YES	A	

2-Thread Flatlock, Wide

For sewing stretchy fabrics together with a decorative effect either with the flatlock side or the ladder stitch side. Create varying effects by threading the lower looper with decorative thread. Read more on page 44.

19				N/R		A/B	
		A	6.5	N	YES	A	

2-Thread Wrapped Overlock, Wide

For sewing two layers of stretchy fabrics together.

20				N/R		A/B	
		A	6.0	N	YES	A	

2-Thread Wrapped Overlock, Narrow

For sewing two layers of stretchy fabrics together.

21				N/R		A/B	
		B	6.5	N	YES	A	

2-Thread Rolled Edge







For edging lightweight fabrics. It gives a nice finish on silky scarves, pillow ruffles and napkins. Thread the lower looper with a decorative thread, such as 40 weight rayon for a beautiful satin edge. Read more on page 43.

Note: Not recommended for heavyweight woven fabrics or medium to heavyweight stretch fabrics.

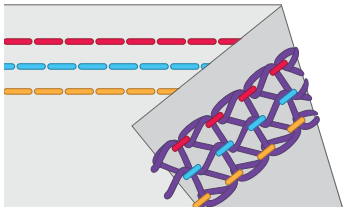
22				N/R		A/B	
		B	6.0	R	YES	A	







Coverstitch, Triple

For hems on stretch fabrics and for decorative effects on all kind of fabrics. Use decorative thread in looper for embellishment. Read more on page 45.

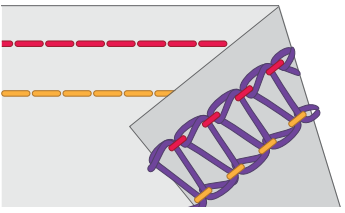
23				N/R		A/B	
		C, D, E	—	R	—	B	







Coverstitch, Wide

For hems on stretch fabrics and for decorative effects on all kind of fabrics. Use decorative thread in looper for embellishment. Read more on page 45.

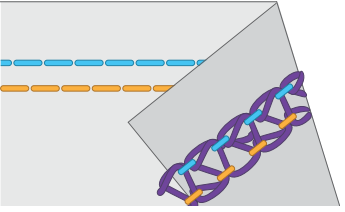
24				N/R		A/B	
		C, E	—	R	—	B	







Coverstitch, Narrow

For hems on stretch fabrics and for decorative effects on all kind of fabrics. Use decorative thread in looper for embellishment. Read more on page 45.

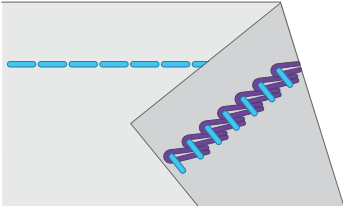
25				N/R		A/B	
		C, D	—	R	—	B	

Chainstitch

For all types of sewing such as construction, hemming and piecing quilts. Baste with ease for construction as it is an easily unraveled stitch, and never run out of bobbin thread. Use decorative thread in looper for embellishment. Read more on page 46.

26				N/R		A/B	
		D	—	R	—	B	

Start Sewing

Tip: Some fabrics have a lot of excess dye which can cause discoloration on other fabric but also on your machine. This discoloring may be very difficult or impossible to remove. Fleece and denim fabric, especially red and blue, often contain a lot of excess dye. If you suspect that your fabric/ready-to-wear garment contains a lot of excess dye, always pre-wash it before sewing to avoid the discoloring of your machine.

When the machine is completely threaded, close the front cover and bring all of the threads over the stitch plate and slightly to the left under the presser foot.

Ensure that the upper cutter moves against the stationary cutter correctly by turning the hand wheel slowly toward you. If the upper cutter blade does not move correctly, check if there are any fabric or waste thread stuck between the blades.

Hold the threads and apply a slight tension.

Turn the hand wheel toward you 2 or 3 complete turns to start making a thread chain. Check if all threads wind around the stitch finger of the stitch plate. If the threads do not wind around the finger, make sure each thread is threaded correctly.

- A. Continue holding the thread chain while pressing the foot control. Sew until the chain is 2"-3" (5-8cm) long.

Place fabric under the front of the presser foot and sew a test sample. Guide the fabric slightly with your left hand while sewing. Do not pull on the fabric as this may deflect the needle, causing it to break.

- B. When you reach the end of the fabric, continue sewing while drawing the finished fabric gently backwards and to the left. This is called chaining off. It prevents the threads from coming undone and prepares for next sewing.
- C. Cut the threads with the thread cutter, leaving a thread chain approximately 2"-3" (5-8cm) long at the end of the fabric. Pull the threads around the thread cutter from the back, then toward you.

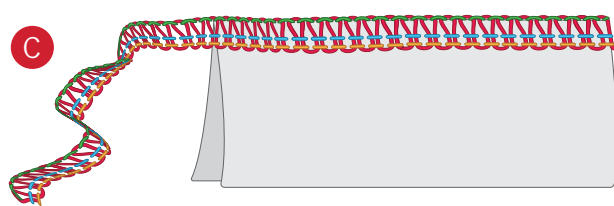
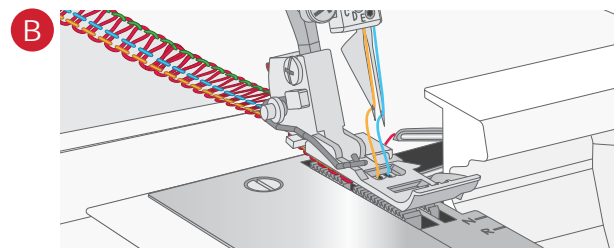
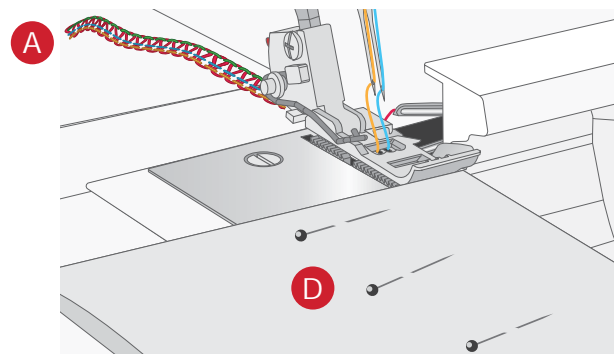

Pin Placement

Insert straight pins to the left of the presser foot (D). The pins will be easy to remove and are away from the cutters.

Note: Sewing over pins will damage and might destroy the edge of the cutters.

Securing the Thread Chain

Tie a Knot

To avoid the thread chain from ravelling, separate and tie the thread ends together.

Use a Sewing Needle

Thread the chain into a large eyed, hand sewing needle.

Insert the needle into the end of the seam and pull the chain into the seam to secure the threads.

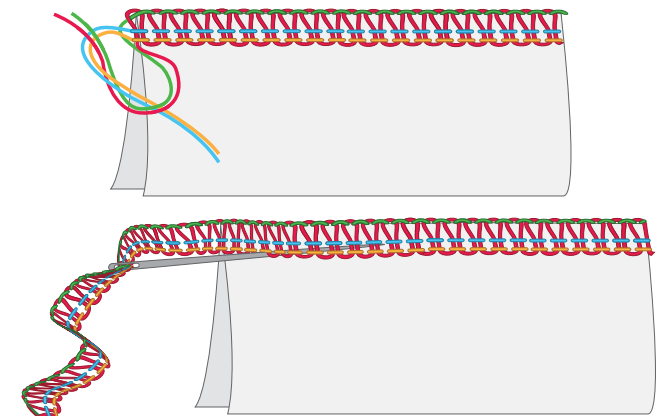

Use the Machine at the Start of a Seam

1. Before placing the fabric in the machine, sew a thread chain approximately 2"-3" (5-8cm) long.
Place your fabric in front of the presser foot. Sew a few stitches and stop.
2. Raise the presser foot and bring the thread chain to the left around and under the presser foot.
Place the thread chain between the presser foot and upper knife, holding it in position as you lower the presser foot to sew.
3. After sewing approximately 1" (2.5 cm), move the chain to the right and under the upper knife, cutting the chain as you sew.

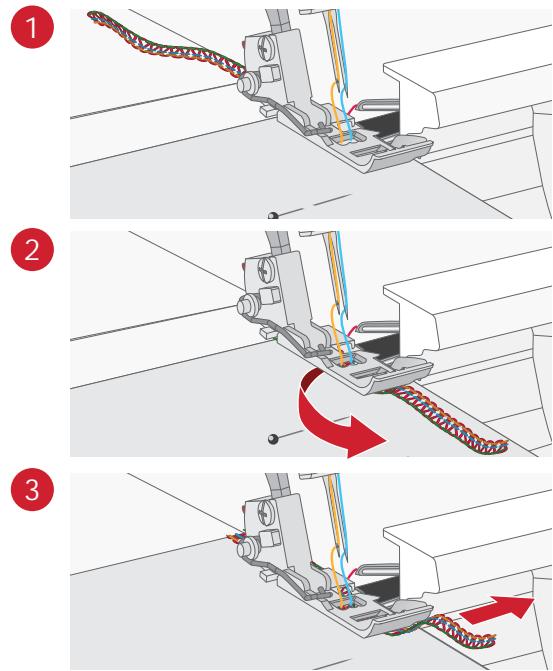

Use the Machine at the End of a Seam

1. Serge one stitch off the end of the seam.
Raise the needle and presser foot, and gently pull the threads off the stitch finger.
2. Turn the fabric over so that the under side is up.
3. Serge approximately 1" (2.5cm) over the stitching and angle off the fabric.

Note: Not for Coverstitch, see page 45.

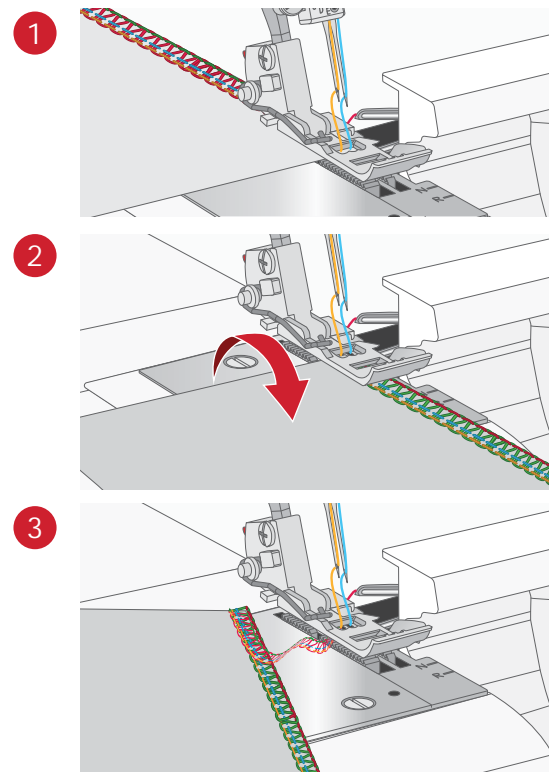

Cutting the Seams Open

Cut the upper looper thread with a seam ripper (not included with the machine) to cut the seams.

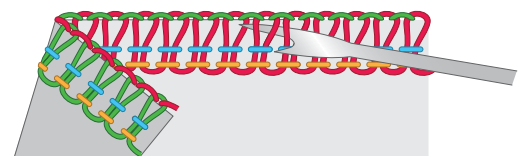

Rolled Edge Sewing

The rolled edge stitch is appropriate for light weight fabrics such as lawn, voile, organdy, crepe, etc. The rolled edge is achieved by adjusting the thread tension to make the fabric edge roll under the fabric while overlocking. Adjust the thread tension to change the degree of rolling. To sew rolled edge you need to set the stitch finger lever to "R".

Tip: For a beautiful rolled edge, thread the upper looper with a decorative thread and the needle and lower looper with lightweight regular thread.

2-Thread Rolled Edge

Select the 2-thread rolled edge stitch.

Engage the 2-thread overlock converter (see page 14).

Use the right needle thread and lower looper thread.

Move the stitch finger lever to "R" (see page 15).

Make a thread chain and test sew on a sample of your fabric before sewing on your project. Hold the thread chain while beginning to sew to keep it from curling into the seam.

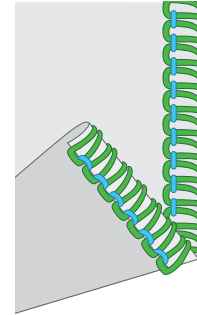

2-Thread Rolled Edge

3-Thread Rolled Edge/Narrow Edge

A variant of the rolled edge stitch is the narrow edge.

Due to different thread tension, the seams get a different appearance and density.

Select the 3-thread rolled edge stitch or the 3-thread narrow edge stitch.

Use the right needle thread and the upper and lower looper threads.

Move the stitch finger lever to "R" (see page 15).

Set the stitch length to "1.2-1.3" for a fine seam.

Make a thread chain and test sew on a sample of your fabric before sewing on your project. Hold the thread chain while beginning to sew to keep it from curling into the seam.

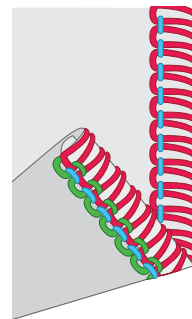

3-Thread Rolled Edge

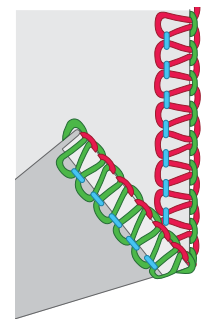

3-Thread Narrow Edge

Flatlock Sewing

A flatlock is made by adjusting the tension of the 3-thread overlock stitch, sewing the seam and pulling the fabrics apart to flatten the seam. The tensions must be adjusted correctly for the fabric to pull flat properly.

A flatlock can be used both as a decorative construction stitch, sewing two pieces together (Standard Flatlock), or for decoration only on one piece of fabric (Decorative Flatlock).

There are two ways to sew a Flatlock. Either with the wrong sides of the fabric together to create a decorative look, or with the right sides together, to create a Ladder Stitch.

Standard Flatlock, Wide

Thread the lower and upper looper and the left needle.

Place the wrong sides of the two pieces of fabric together to sew a decorative stitch on the right side of the project.

Sew the seam, trimming the excess fabric. The needle thread will form a V on the underside of the fabric. The lower looper thread will pull into a straight line at the fabric edge.

Unfold the fabric and pull on opposite sides of the seam to pull the stitches flat.

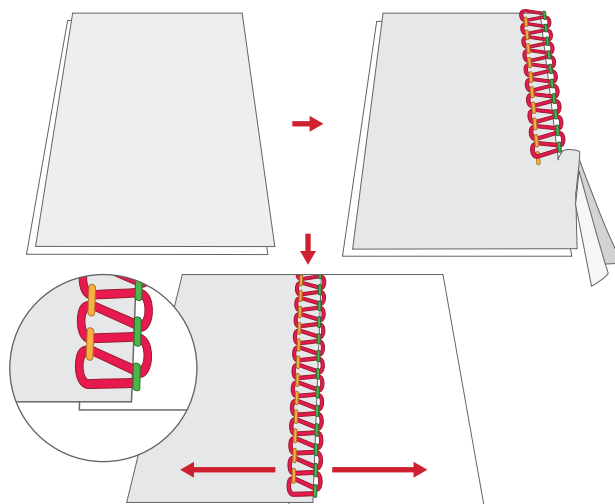

Decorative Flatlock, Wide

Deactivate the upper cutter (see page 14). The fabric should not be trimmed on this stitch.

Thread the lower looper, upper looper and the left needle.

Fold the fabric piece, wrong sides together, to sew a decorative stitch on the right side of the project.

Position the fabric so the seam is sewn with part of the stitch extending off the fabric.

Unfold the fabric and pull on opposite sides of the stitch to flatten.

Tip: The upper looper thread is the prominent thread in the flatlock stitch. Place a decorative thread in the upper looper and regular threads in the lower looper and needle.

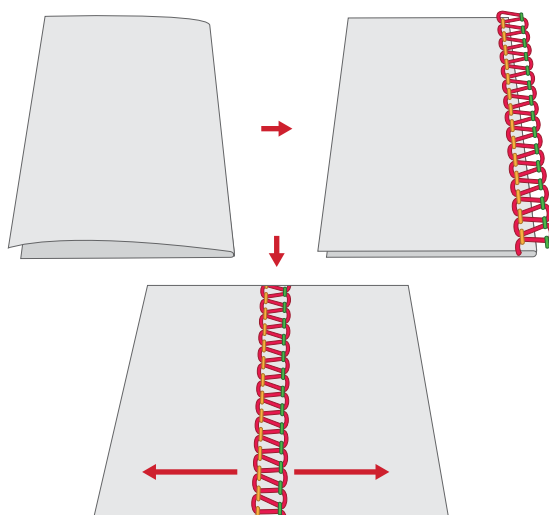

Ladder Stitch

A ladder stitch is sewn as a decorative flatlock, but is sewn with the right sides of the fabric together. The needle thread will be the prominent thread that creates the ladder.

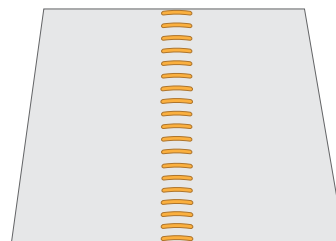

Coverstitch Sewing

The coverstitch can be used for covering, binding or top-stitching necklines and for hemming the bottom of T-shirts and sweatsuits, etc., in addition to flat joining seams (plain seaming). The coverstitch is most suitable for stretchy fabrics. It can also be used for woven fabrics.

Note: The free arm is convenient for sewing trousers legs and other small areas such as children's garments (see page 11).

Machine Set Up

Deactivate the upper cutter (see page 14). The fabric should not be trimmed on this stitch.

Set the stitch finger lever to R (see page 15).

If inserted, remove needle A and needle B.

Install needles C, D and/or E depending on desired coverstitch.

Deactivate the upper looper (see page 15).

Remove Cutter Cover A and install Coverstitch Table B (see page 12). The markings on Coverstitch Table B indicate the distance, in cm and inches, from the coverstitch middle needle. Use it as a guide when positioning the fabric edge.

Set the machine in Threading Position (page 15) and thread the machine.

Set the machine in Sewing Position (page 15) and close the front cover.

Start Sewing

Raise the presser foot.

Place fabric under the presser foot behind the needle.

Lower the presser foot.

Press the foot control to start sewing.

Note: When you start to sew from the middle of the fabric, place the fabric at the desired starting point of sewing.

Securing the Coverstitch Seam End

Chaining off is not possible after sewing coverstitch because it causes the seam to unravel when the looper thread is pulled out at the end of sewing. Therefore, secure the seam end in the following manner.

When Sewing Through to the Edge of Fabric

1. Separate the thread ends.
2. Knot the needle threads (2 or 3 threads) together first.
3. Tie these threads with the looper threads.

Cut extra threads.

When Sewing is Stopped Halfway

Raise the presser foot and turn the handwheel one full rotation away from you. Pull the fabric under and behind the presser foot while securing the thread ends with your thumb and your forefinger to prevent the seam from unraveling.

Pull out the needle threads (2 or 3 threads) on the underside of the fabric and knot the threads in the same manner as described above.

Cut extra threads.

Note: Normally, the seams at the start of sewing do not unravel, but it is wise to secure the seam end following the same steps as described when sewing through to the edge of the fabric.

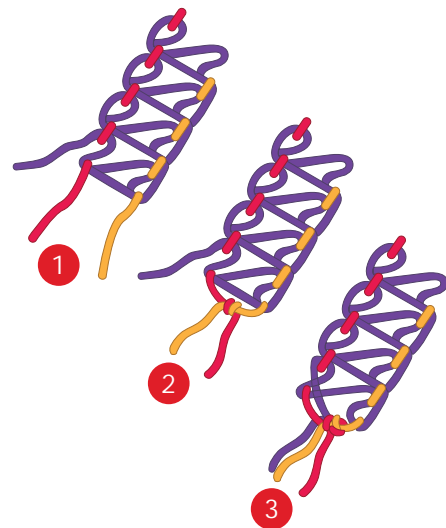

Chainstitch Sewing

The chainstitch is sewn with two threads, one needle and one looper. Normally, the machine trims the fabric edge while the seam is being sewn. However, a chainstitch seam can be placed at a desired distance from edge of fabric by putting the upper cutter in B position, disengaging the upper looper and installing coverstitch table B (see page 12).

 *Turn off the main power switch and unplug the machine.*

Machine Set Up

Deactivate the upper cutter (see page 14). The fabric should not be trimmed on this stitch.

If inserted, remove needle A, B, C and E.

Install needle D.

Deactivate the upper looper (see page 15).

Remove Cutter Cover A and install Coverstitch Table B (see page 12). The markings on Coverstitch Table B indicate the distance, in cm and inches, from the coverstitch middle needle. Use it as a guide when positioning the fabric edge.

Set the machine in Threading Position (page 15) and thread the machine.

Set the machine in Sewing Position (page 15) and close the front cover.

Start and End Sewing

When starting to sew after threading the machine, sew 2-3 cm on a scrap fabric and chain off to make a chain.

At end of sewing, pull the fabric lightly to the rear of machine and chain off.

Sewing Tips & Hints

Sewing with Decorative Thread in the Loopers

Heavy decorative threads can be a beautiful highlight to your sewing project. Thread the loopers as described in the threading section (see page 33).

When using decorative threads, remove the spool holder and place the spool caps as shown, to prevent the thread from getting caught on the edge of the spool.

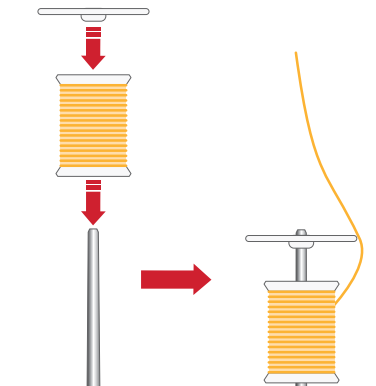

Gathering with Differential Feed

The differential feed can be used to gather lightweight fabrics. Use it for sleeves, making ruffles, and more.

Set the differential feed between 1.5 and 2 to obtain the best gathering effect for your project. Always test sew on a scrap piece of your fabric first. See page 49, to learn how to adjust the differential feed.

Set the stitch length to 4-5 depending on the fabric.

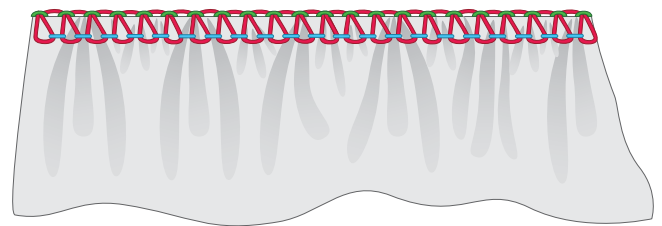

Sewing Corners

Outer Corners

Trim three of the corners approximately 1¼" (3cm) as illustrated (A). Start sewing at the corner that is not trimmed.

When you reach a corner, stop the machine. Raise the needle and the presser foot. Remove the threads from the stitch finger. Turn the fabric and align the cutting line with the upper knife (B).

Lower the presser foot lifter. Continue to sew from where the previous stitches on the corner ended.

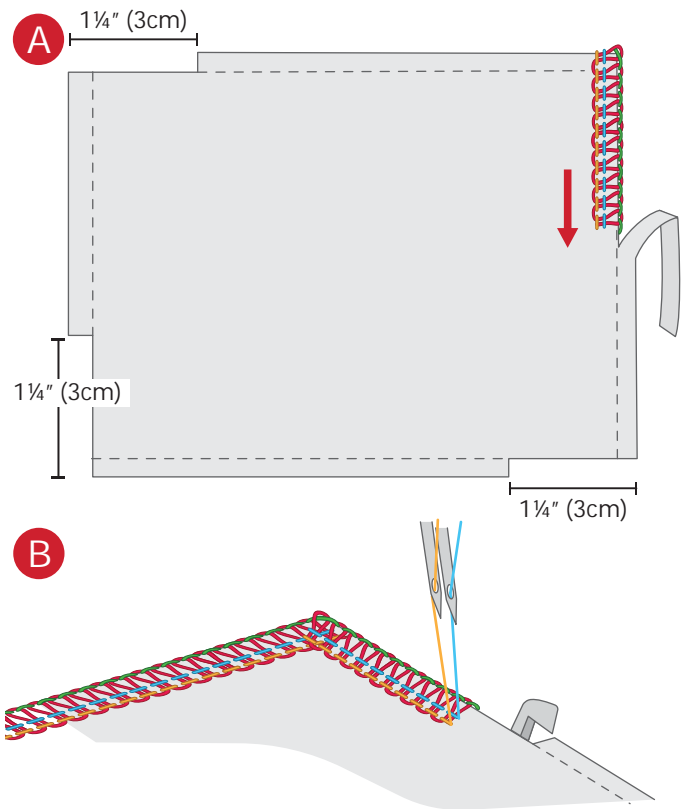

Inner Corners

Cut the inner corner as illustrated (A). Sew and stop approximately 1¼" (3 cm) before the inner corner.

Turn the fabric so that the cutting lines are straight (B).

Continue sewing.

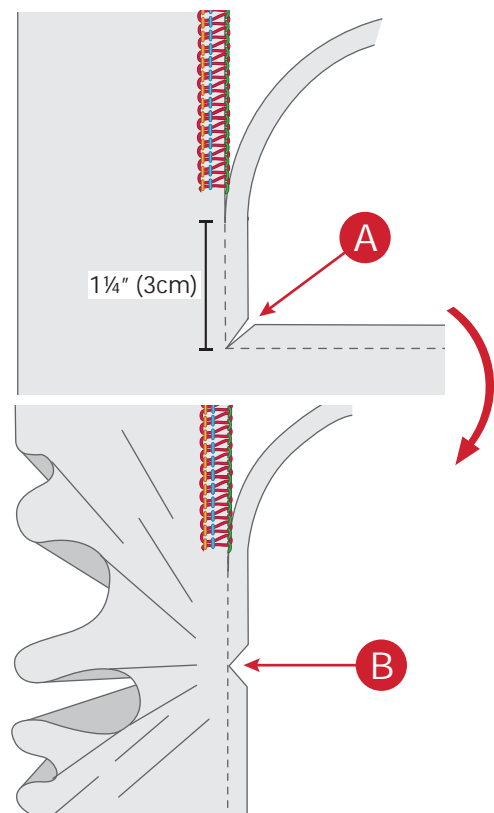

6 Stitch Adjustments

Presser Foot Pressure

The presser foot pressure for sewing based on normal conditions should be set to "N" (A). Adjustments may be necessary due to fabric type and weight. Increase or decrease the pressure until you are satisfied with the result. Always test sew on a sample of your fabric before sewing on your garment.

Less pressure: Decrease the pressure by turning the dial in counter-clockwise direction to a value between N and 1.

More pressure: Increase the pressure by turning the dial in clockwise direction to a value between N and 7.

Back to standard setting: Turn the adjustment dial until the mark on the knob is set to N.

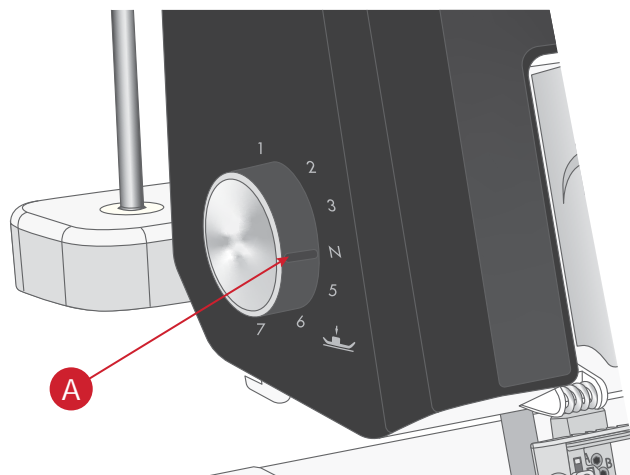

Stitch Width Adjustment

The stitch width can be increased or decreased by changing the needle position or with the cutting width dial.

Adjustment Using Needle Position

When only the left needle, or when both needles are used the stitch width is 6 mm (A).

When only the right needle is used the stitch width is 4 mm (B).

When using the chainstitch needle the stitch width is 9 mm (C).

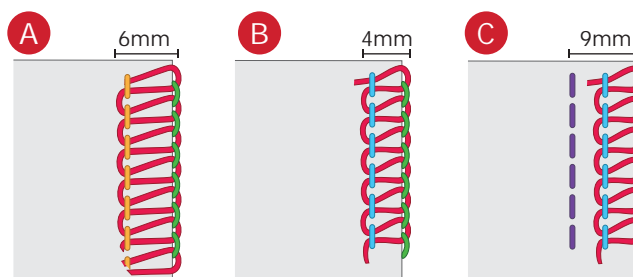

Adjustment Using Cutting Width Dial

The cutting width can be fine tuned by turning the cutting width dial (A). By doing so, the upper cutter position and cutting width can be adjusted within the range shown below.

When only the left needle is used: 5 - 7 mm

When only the right needle is used: 3 - 5 mm

When using the chainstitch needle: 8 - 10 mm

For standard setting the dial should be set to 6.0.

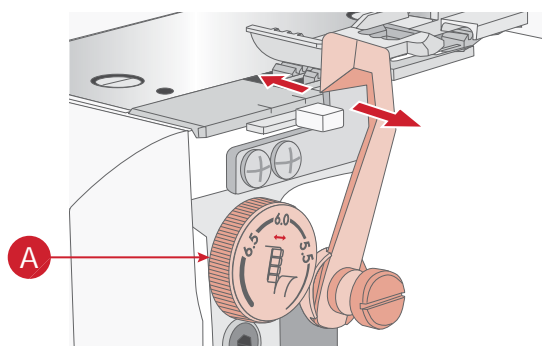

Stitch Length Adjustments

Stitch length is automatically set when selecting a stitch but it may have to be adjusted depending on fabric type. Adjust the stitch length to 4 mm when sewing on heavyweight fabrics. Adjust the stitch length to 2 mm when sewing on lightweight fabrics.

To adjust the stitch length, touch + or -. The value number becomes highlighted, indicating that the standard setting has been changed.



Stitch length icon

Differential Feed Adjustment

The differential feed system consists of two sets of feed teeth arranged one behind the other. Both feed teeth work independently of each other to give perfect results when sewing on speciality fabrics. When the amount of feed by the front feed teeth is changed in relation to the feed by the rear feed teeth it will "stretch" or "gather" the fabric.

Use the differential feed to prevent stretching of knit fabrics and puckering of lightweight fabrics.

The differential feed is automatically set to 1.0 when any of the stitches is selected. This is the setting for overlock stitching on normal fabric. To adjust the differential feed, touch + or - (the value number becomes highlighted, indicating that the standard setting has been changed).

Normally, the seam and fabric should lay flat (A).

If the sewn fabric stretches (B), adjust the value toward 2.0.

If the sewn fabric is gathered (C), adjust the value toward 0.5.



Differential feed icon

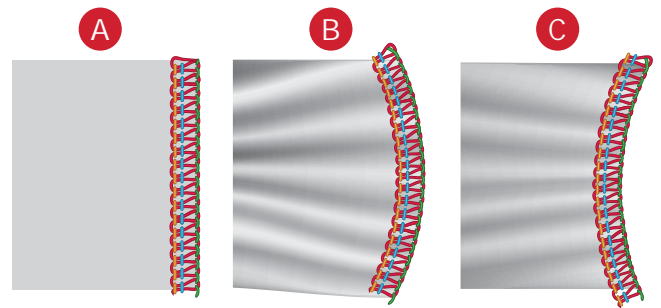

Thread Tension

Thread tension is automatically set when selecting a stitch but it may have to be fine tuned depending on:

- Type and thickness of the fabric
- Needle size
- Size, type and fiber content of the thread

See page 17 for how to adjust the thread tension settings.

The below describes how the tension settings can be adjusted for 4-thread overlock stitch.

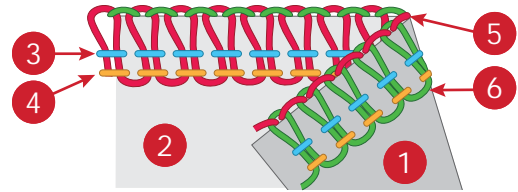

- 1. Wrong side of fabric
- 2. Right side of fabric
- 3. Right needle thread
- 4. Left needle thread
- 5. Upper looper thread
- 6. Lower looper thread

Correct Tension

Lower looper thread and upper looper thread should be well balanced with the same tension (both looper threads should cross at the edge of the fabrics). Needle threads should not be too loose or too tight, but equally balanced tension.

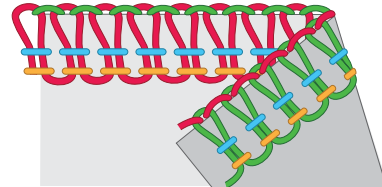

Upper Looper Tension

When the upper looper thread is too loose (A): Tighten the thread tension of the upper looper or loosen the thread tension of the lower looper.

When the upper looper thread is too tight (B): Loosen the thread tension of the upper looper or tighten the thread tension of the lower looper.

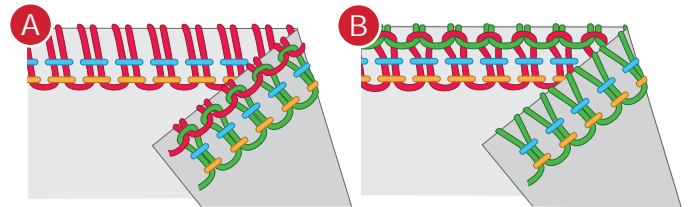

Lower Looper Tension

When the lower looper thread is too loose (C): Tighten the thread tension of the lower looper or loosen the thread tension of the upper looper.

When the lower looper thread is too tight (D): Loosen the thread tension of the lower looper or tighten the thread tension of the upper looper.

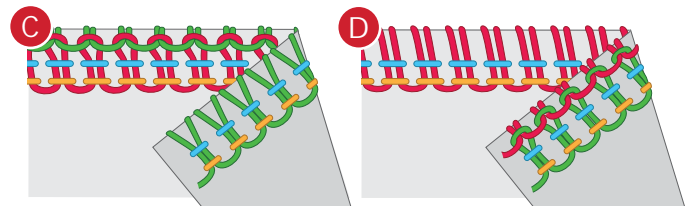

Left Needle Tension

When the left needle thread is too loose (E): Tighten the thread tension of the left needle or loosen both looper threads.

When the left needle thread is too tight (F): Loosen the thread tension of the left needle.

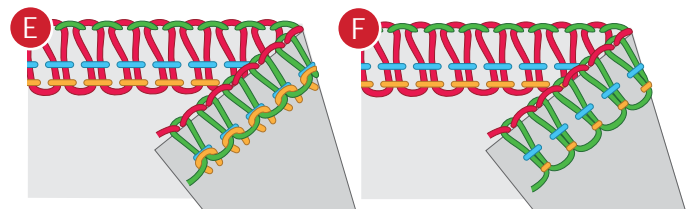

Right Needle Tension

When the right needle thread is too loose (G): Tighten the thread tension of the right needle.

When the right needle thread is too tight (H): Loosen the thread tension of the right needle.

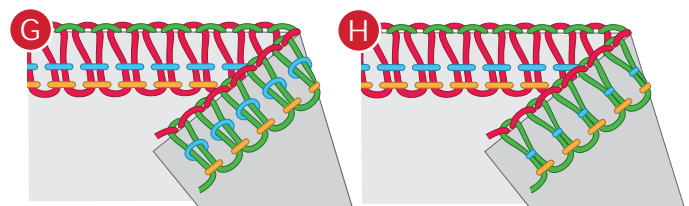

7 Maintenance

Cleaning

After use, wipe the exterior surface of your machine and the touch screen with a soft and damp cloth to remove any dust or lint built up.

Cleaning the Looper Area

 Turn off the main power switch and unplug the machine.

Open the front cover.

With a forward brushing movement, use the lint brush to remove any lint.

Note: You may use a vacuum cleaner to clean the upper knife area or feed teeth.

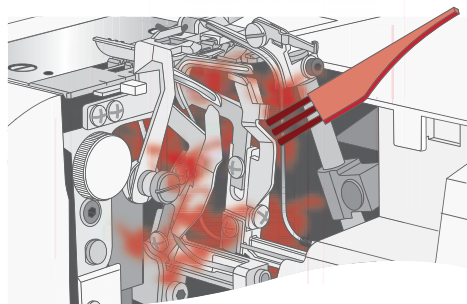

Cleaning the Looper Threading Pipes

Use the looper threading wire to clean the pipe of the looper threader device.

Set the Threading/Sewing lever to "Threading" position by sliding it to the left.

Turn the handwheel slowly toward you until it will click and is locked in threading position.

Take the looper threading wire and push the straight end (not the loop end) through the looper threader hole until it comes out from the hole of the looper tip (A).

Use a 60wt thread about 24" (60cm) long to clean the looper threader pipes. Pass the thread through the loop of the looper threading wire until the loop is at the halfway point of the thread (B).

Carefully pull the end of the looper threading wire until the thread comes out from the hole of the looper tip (C).

Pull the thread until it is all the way through the threader pipe.

Repeat the above procedure 2-3 times.

With the machine unthreaded, push the looper threader button 4-5 times to clean out the remaining lint (D).

Set the Threading/Sewing lever to "Sewing" position.

Close the front cover.

Note:

Clean the looper threader pipe once every 10 hours of use or when the looper threader does not work well.

You can also use an compressed air duster or camera dust blower to clean the looper threader pipe.



Threading Position

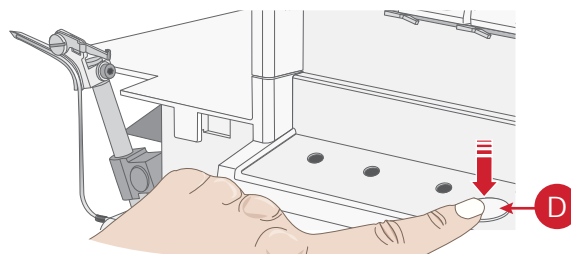
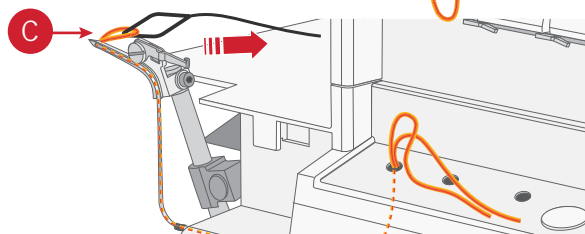
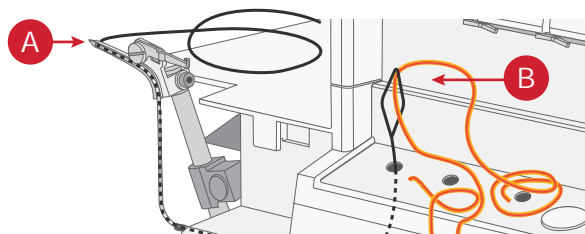

Sewing Position

Oiling

 Turn off the main power switch and unplug the machine.

To keep the machine running smoothly and quietly the moving parts (on the upper looper), pointed out in the picture, must be lubricated often. We recommend lubricating once a week for normal use or once every 10 hours of continuous use.

Use sewing machine oil. Do not use any other oil, it could damage the machine.

With the machine unthreaded, place a scrap of fabric under the presser foot and run the machine for a few minutes.

Wipe the machine surface to remove all excess oil before sewing.

 Important when oiling!
Never inject oil into the looper threader holes, or the looper tips.

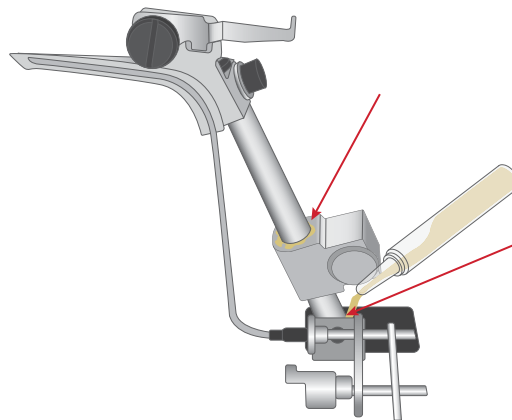

Replace the Upper Cutter

 Turn off the main power switch and unplug the machine.

The movable upper cutter should be changed when it becomes dull. The upper cutter can be replaced according to the following directions. If you are having any difficulties, consult your authorized service technician.

Open the front cover and set the movable upper cutter (A) in A position (see page 14).

Loosen the set screw (B), by turning it towards you, and remove the upper cutter.

Turn the handwheel until the upper cutter holder is in its lowest position.

Place a new upper cutter in the groove of the upper cutter holder and tighten the set screw (C).

Make sure the front edge of the movable upper cutter is 0.5-1.0 mm lower than the cutting edge of the stationary cutter (D).

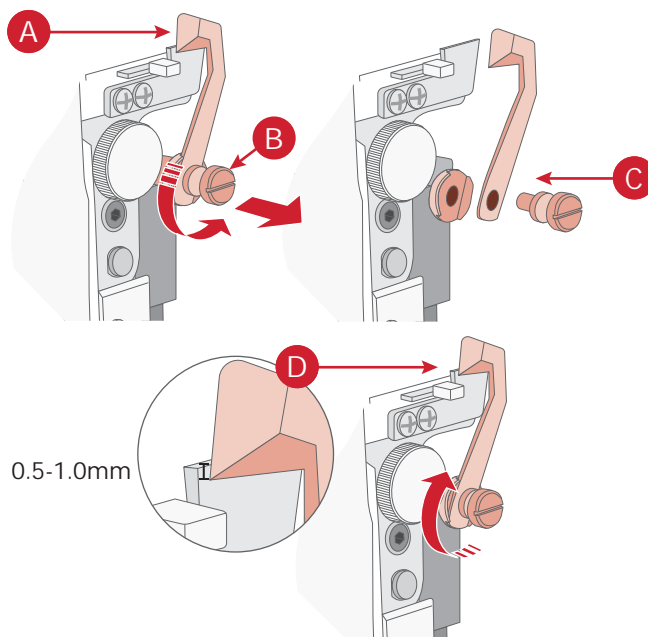

Storage

When the machine is not in use, be sure to keep it unplugged. Cover the machine with the soft dust cover to protect it and store the machine, so it is not exposed to direct sunlight or humidity.

Servicing

If you have any questions regarding service and/or operation, contact our Customer Care department.

Trouble Shooting

Machine Does Not Run

Possible Cause: Machine not properly connected to power source.

Solution: *Check that machine has been properly connected to power source (page 9).*

Possible Cause: The safety device is activated.

Solution: Close open covers and lower the presser foot.

Fabric Does Not Feed Well

Possible Cause: Stitch length is set too short for the fabric being sewn.

Solution: *Increase the stitch length setting (page 18, page 49).*

Possible Cause: Differential feed is not set in the correct position for the fabric being sewn.

Solution: *Adjust the differential feed (page 17, page 49).*

Possible Cause: Presser foot pressure not correctly set for fabric being sewn.

Solution: *Adjust presser foot pressure (page 48).*

Needle Breaks

Possible Cause: Needle may not be properly seated in the needle clamp.

Solution: *Insert needle so that it is all the way up in the needle clamp, then tighten the screw securely (page 13).*

Possible Cause: Manually pulling fabric from behind presser foot while sewing which causes needles to deflect.

Solution: *Refrain from pulling fabric manually; allow feed teeth to draw fabric under presser foot.*

Possible Cause: Needle may not be the correct size for the fabric being sewn.

Solution: *Use a needle size that is compatible for the fabric (page 21).*

Thread Breaks

Possible Cause: Machine may not be threaded correctly; threads threaded in the incorrect sequence.

Solution: *Check that machine is threaded in correct order (from left to right).*

Possible Cause: Thread is not unreeling smoothly off the thread spool.

Solution: *Check the thread spool to ensure thread is not getting caught.
Place the thread spool and spool cap as shown on page 22.*

Possible Cause: Needle(s) may have a bent, dull or broken point.

Solution: *Replace needle(s) (page 13).*

Possible Cause: The needle is inserted incorrectly.

Solution: *Insert the needle correctly (page 13).*

Possible Cause: Using thread that is poor quality or has uneven filament.

Solution: *Use good quality thread with a smooth, even filament.*

Possible Cause: Thread tension is set too tight.

Solution: *Loosen thread tension (page 17, page 50).*

Possible Cause: Thread is caught in one of the thread guides.

Solution: *Check threading path to ensure all threads are feeding smoothly.*

Stitches Skipping

Possible Cause: Needle(s) may have a bent, dull or broken point.

Solution: *Replace needle(s) (page 13).*

Possible Cause: Needle may not be properly seated in the needle clamp.

Solution: *Insert needle so that it is all the way up in the needle clamp, then tighten the screw securely.*

Possible Cause: Needle may not be the correct size for the fabric being sewn.

Solution: *Use a needle size that is compatible for the fabric (page 21).*

Possible Cause: Machine may not be threaded correctly or threads were threaded in the incorrect sequence.

Solution: *Check that machine is threaded in correct order as shown in machine manual (from left to right).*

Possible Cause: Using thread that is poor quality or has uneven filament.

Solution: *Use good quality thread with a smooth, even filament.*

Irregular Stitches

Possible Cause: Stitches are not balanced.

Solution: *Adjust thread tensions and possibly cutting width (page 17, page 48).*

Possible Cause: Thread is not unreeling smoothly off the thread spool.

Solution: *Check the thread spool to ensure thread is not getting caught.*

Place the thread spool and spool cap as shown on page 22.

Possible Cause: Machine may not be threaded correctly or threads threaded in the incorrect sequence.

Solution: *Check that machine is threaded in correct order (from left to right).*

Fabric Puckers

Possible Cause: Thread tensions are set too tightly.

Solution: *Loosen thread tensions (page 17, page 50).*

Possible Cause: Thread is not unreeling smoothly off the thread spool.

Solution: *Check the thread spool to ensure thread is not getting caught.*

Place the thread spool and spool cap as shown on page 22.

Possible Cause: Using thread that is poor quality or has uneven filament.

Solution: *Use good quality thread with a smooth, even filament.*

Possible Cause: Stitch length is set too short.

Solution: *Adjust stitch length to a longer setting (page 49,).*

Possible Cause: Differential Feed is not set in the correct position for the fabric being sewn.

Solution: *Adjust the differential feed (page 17, page 49).*

Irregular Trimming

Possible Cause: Upper – and stationary cutters are not in proper position.

Solution: *Check alignment of cutters (page 52).*

Possible Cause: Cutter(s) are damaged or worn out.

Solution: *Replace one or both cutters (page 52).*

Fabric Jams

Possible Cause: Upper – and stationary cutters are not in proper position.

Solution: *Check alignment of cutters (page 52).*

Possible Cause: Thread is not unreeling smoothly off the thread spool.

Solution: *Check the thread spool to ensure thread is not getting caught.*

Place the thread spool and spool cap as shown on page 22.

Possible Cause: Too much fabric thickness.

Solution: *Compress thick layers with conventional sewing machine before sewing on your overlock machine.*

The Looper Threader Does Not Work

Possible Cause: The Threading/Sewing lever is not set to the “Threading” position.

Solution: *Set the Threading/Sewing position lever to threading position (page 15).*

Possible Cause: The thread is not correctly inserted into the looper threader hole.

Solution: *Insert at least 2cm of thread into the looper hole.*

Possible Cause: The thread is not long enough.

Solution: *Pull out approximately 22" (56 cm) of thread before putting it in the looper threading hole.*

Possible Cause: The thread is tangled, wet or frayed.

Solution: *Trim the thread end.*

Possible Cause: Lint is accumulated in the looper threader pipe.

Solution: *Clean the looper threading pipe (page 51).*

Technical Specifications

Sewing Speed Maximum 1100 ± 150rpm	Stitch Length 1-5mm	Presser Foot Rise 6mm
Needles PFAFF® ELx705 #90/14, #12/80	Stitch Width 3-7mm	Weight 10.8g
Number of Needles 1-3	Differential Feed Ratio 0.6-2.0	Machine Dimensions Width: ≈418mm Depth: ≈295mm Height: ≈301mm
Number of Threads 2-5	Type of Lamp LED light x5	Rated Voltage 120V/60Hz (North America) 230V/50Hz (Europe)
Protection Class II (Europe)	Power Rating Machine: 90Watt LED Light: 1.6Watt	