

*ellageo*<sup>®</sup>  
PLUS

*Instruction and  
Reference Guide*

Model BLL2



**FOR THE LOVE OF SEWING**

---

To register your warranty and receive product updates and offers, register your Baby Lock machine on [babylock.com/profile](http://babylock.com/profile). If you have questions with registration, visit your Authorized Baby Lock Retailer.

Baby Lock Consumer Helpline: 800-313-4110

[www.babylock.com](http://www.babylock.com)



# IMPORTANT SAFETY INSTRUCTIONS

When using this machine, basic safety precautions should always be taken, including the following:  
Read all instructions before using.

**DANGER** - To reduce the risk of electric shock:

1. The machine should never be left unattended while plugged in. Always unplug the machine from the electrical outlet immediately after using and before cleaning.

**WARNING** - To reduce the risk of burns, fire, electric shock, or injury to persons:

1. Do not allow this machine to be used as a toy. Close attention is necessary when the machine is used by or near children.
2. Use this machine only for its intended use as described in this manual. Use only accessories recommended by the manufacturer as contained in this manual.
3. Never operate this machine if it has a damaged cord or plug, if it is not working properly, if it has been dropped or damaged, or dropped into water. Return the machine to the nearest authorized retailer or service center for examination, repair, electrical or mechanical adjustment.
4. Never operate the machine with any air openings blocked. Keep ventilation openings of the machine and foot control free from the accumulation of lint, dust, and loose cloth.
5. Never drop or insert any object into any opening.
6. Do not use outdoors.
7. Do not operate where aerosol (spray) products are being used or where oxygen is being administered.
8. To disconnect, turn the main switch to the symbol "○" position which represents off, then remove plug from outlet.
9. Do not unplug by pulling on cord. To unplug, grasp the plug, not the cord.
10. Keep fingers away from all moving parts. Special care is required around the machine needle.
11. Always use the proper needle plate. The wrong plate can cause the needle to break.
12. Do not use bent needles.
13. Do not pull or push fabric while stitching. It may deflect the needle causing it to break.
14. Switch the machine to the symbol "○" position when making any adjustments in the needle area, such as threading needle, changing needle, threading bobbin, or changing presser foot, and the like.
15. Always unplug the machine from the electrical outlet when removing covers, lubricating, or when making any other user servicing adjustments mentioned in the instruction manual.
16. This sewing machine is not intended for use by young children or infirm persons without supervision.
17. Young children should be supervised to ensure that they do not play with this machine.
18. If the LED light unit (light-emitting diode) is damaged, it must be replaced by authorized dealer.
19. Hold the foot controller plug when rewinding into cord reel. Do not allow the plug to whip when rewinding.

**SAVE THESE INSTRUCTIONS**

**This machine is intended for household use.**

# FOR USERS IN THE UK, EIRE, MALTA AND CYPRUS ONLY

If this machine is fitted with a three-pin non-rewireable BS plug, then please read the following.

## IMPORTANT

If the available socket outlet is not suitable for the plug supplied with this equipment, it should be cut off and an appropriate three-pin plug fitted. With alternative plugs, an approved fuse must be fitted in the plug.

## NOTE

The plug severed from the main lead must be destroyed, as a plug with bared flexible cords is hazardous if engaged in a live socket outlet. In the event that the plug fuse must be replaced, use a fuse approved by ASTA to BS 1362, i.e., carrying the  mark, rated as marked on the plug.

Always replace the fuse cover; never use plugs with the fuse cover omitted.

## WARNING

**DO NOT CONNECT EITHER WIRE TO THE EARTH TERMINAL, WHICH IS MARKED WITH THE LETTER 'E', BY THE EARTH SYMBOL (  ) OR COLOURED GREEN OR GREEN AND YELLOW.**

The wires in this main lead are coloured in accordance with the following code:

Blue	Neutral
Brown	Live

As the colours of the wiring in the main lead of this appliance may not correspond with the coloured markings identifying the terminals in your plug, proceed as follows.

The wire that is coloured blue must be connected to the terminal that is marked with the letter 'N' or coloured black or blue.

The wire that is coloured brown must be connected to the terminal that is marked with the letter 'L' or coloured red or brown.

# Federal Communications Commission (FCC)

## Declaration of Conformity (For USA Only)

Responsible Party: Tacony Corporation  
1760 Gilsinn Lane,  
Fenton, Missouri 63026

declares that the product

Product Name: Baby Lock Sewing Machine  
Model Number: BLL2

Complies with Part 15 of the FCC Rules. Operation is subject to the following two conditions: (1) this device may not cause harmful interference, and (2) this device must accept any interference received, including interference that may cause undesired operation.

This equipment has been tested and found to comply with the limits for a Class B digital device, pursuant to Part 15 of the FCC Rules. These limits are designed to provide reasonable protection against harmful interference in a residential installation. This equipment generates, uses, and can radiate radio frequency energy and, if not installed and used in accordance with the instructions, may cause harmful interference to radio communications. However, there is no guarantee that interference will not occur in a particular installation. If this equipment does cause harmful interference to radio or television reception, which can be determined by turning the equipment off and on, the user is encouraged to try to correct the interference by one or more of the following measures:

- Reorient or relocate the receiving antenna
- Increase the separation between the equipment and receiver.
- Connect the equipment into an outlet on a circuit different from that to which the receiver is connected.
- Consult the retailer or an experienced radio/TV technician for help.
- The included interface cable should be used in order to ensure compliance with the limits for a Class B digital device.
- Changes or modifications not expressly approved by Tacony Corporation could void the user's authority to operate the equipment.

# CONGRATULATIONS ON CHOOSING OUR MACHINE

Your machine is the most advanced computerized household embroidery and sewing machine. To fully enjoy all the features incorporated, we suggest that you study the manual.

## PLEASE READ BEFORE USING THIS MACHINE

### For safe operation

1. Be sure to keep your eye on the needle while sewing. Do not touch the handwheel, thread take-up lever, needle, or other moving parts.
2. Remember to turn off the power switch and unplug the cord when:
  - Operation is completed
  - A power failure occurs during use
  - Maintaining the machine
  - Leaving the machine unattended.
3. Do not store anything on the foot controller.
4. Plug the machine directly into the wall. Do not use extension cords.

### For a longer service life

1. When storing this machine, avoid direct sunlight and high humidity locations. Do not use or store the machine near a space heater, iron, halogen lamp, or other hot objects.
2. Use only neutral soaps or detergents to clean the case. Benzene, thinner, and scouring powders can damage the case and machine, and should never be used.
3. Do not drop or hit the machine.
4. Always consult the operation manual when replacing or installing any assemblies, the presser feet, needle, or other parts to assure correct installation.

### For repair or adjustment

In the event a malfunction occurs or adjustment is required, first follow the troubleshooting table in the back of the operation manual to inspect and adjust the machine yourself. If the problem persists, please consult your local authorized Baby Lock retailer.

**For additional product information and updates, visit our web site at [www.babylock.com](http://www.babylock.com)**

**The contents of this manual and specifications of this product are subject to change without notice.**

# HOW TO USE THIS MANUAL

Chapters 1 and 2 describe to the first-time user the initial operations for using this machine and the basic sewing operations.

## To sew utility stitches

Continue with chapter 3 to learn how to select a stitch and sew using the various stitches.

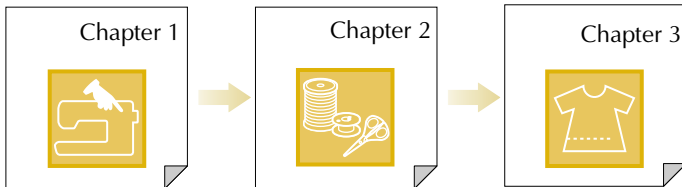

## To sew characters and patterns

Continue with chapter 4 to learn basic operations, from selecting patterns to sewing, in addition to operations such as combining and editing patterns to rotate or resize them, and storing combined patterns.

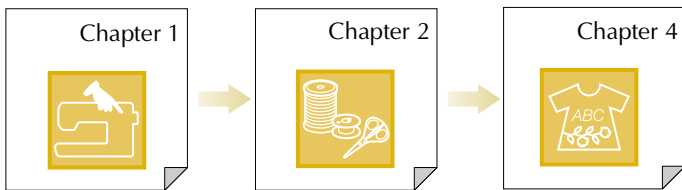

## To embroider

Continue with chapter 5 to learn basic embroidering operations, from selecting patterns to sewing, as well as operations such as editing patterns to rotate or resize them and utilizing more useful functions or techniques. In chapter 6, you can learn how to edit more advanced embroidery patterns and combine patterns.

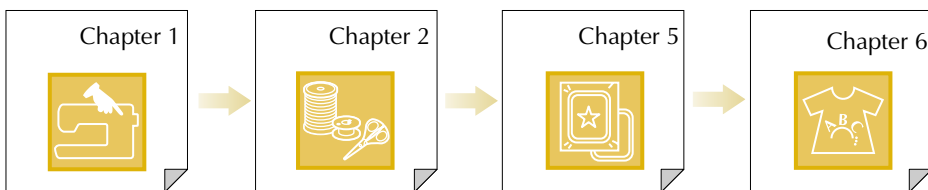

- Parts related to operations described in the procedures are highlighted in gold. Perform the operations while comparing the screens in the procedures with those that appear on the machine.
- If, while using the machine, you have questions about an operation or you would like to know more about a specific function, refer to the index (P.207) and the table of contents to find the section of the manual to refer to.

# CONTENTS

NAMES OF MACHINE PARTS AND THEIR FUNCTIONS.....	9	Top Stitching.....	74
Machine .....	9	Smocking.....	74
Needle and Presser Foot Section.....	10	Fagoting.....	75
Embroidery Unit .....	10	Tape or Elastic Attaching.....	76
Operation Buttons .....	11	Heirloom Stitching.....	77
Included Accessories .....	11	Buttonhole Stitches .....	79
Options .....	14	Bar Tacks.....	84
<b>Chapter 1 Getting Ready</b> .....	<b>15</b>	Button Sewing.....	86
TURNING THE MACHINE ON/OFF.....	16	Eyelets .....	87
LCD SCREEN.....	17	Multi-Directional Sewing (Straight Stitch and Zigzag Stitch) .....	88
Using the Machine Setting Mode Key .....	20	Zipper Insertion .....	89
Using the Machine Operation Mode Key .....	22	<b>Chapter 4 Character/Decorative Stitches</b> .....	<b>93</b>
Using the Pattern Explanation Key .....	23	SELECTING STITCH PATTERNS .....	94
LOWER/UPPER THREADING.....	24	Selecting Decorative Stitch Patterns/ 7 mm Decorative Stitch Patterns/ Satin Stitch Patterns/ 7 mm Satin Stitch Patterns/Cross Stitch Patterns/ Utility Decorative Stitch Patterns.....	95
Winding the Bobbin .....	24	Alphabet Patterns.....	95
Setting the Bobbin .....	27	SEWING STITCH PATTERNS .....	97
Pulling Up the Bobbin Thread .....	28	Sewing Attractive Finishes.....	97
Upper Threading .....	29	Basic Sewing.....	97
Using the Twin Needle .....	32	Adjusting Patterns .....	98
CHANGING THE PRESSER FOOT.....	34	EDITING STITCH PATTERNS .....	100
Removing the Presser Foot.....	34	Changing the Pattern Size .....	101
Attaching the Presser Foot.....	34	Changing the Pattern Length (7 mm Satin Stitch Patterns Only).....	101
CHANGING THE NEEDLE .....	35	Creating a Vertical Mirror Image .....	101
<b>Chapter 2 Sewing Basics</b> .....	<b>39</b>	Creating a Horizontal Mirror Image .....	101
SEWING.....	40	Selecting a Single/Repeating Pattern.....	102
Sewing a Stitch .....	40	Changing the Thread Density (Satin Stitch Patterns Only).....	102
Sewing Reinforcement Stitches .....	42	Checking the Image .....	103
Sewing Curves .....	42	COMBINING STITCH PATTERNS.....	104
Changing Sewing Direction .....	42	Before Combining Patterns.....	104
Sewing Heavyweight Fabric.....	43	Combining Patterns From Different Categories.....	104
Sewing Lightweight Fabric .....	43	Combining Stitch Patterns of Different Sizes.....	106
ADJUSTING STITCH SETTINGS.....	44	Combining Stitch Patterns of Different Orientations.....	106
Adjusting the Stitch Width .....	44	Combining Stitch Patterns of Different Lengths.....	107
Adjusting the Stitch Length .....	44	Creating Step Patterns (7 mm Satin Stitch Patterns Only).....	108
Adjusting the Thread Tension .....	45	USING THE MEMORY FUNCTION .....	110
USEFUL FUNCTIONS .....	46	Stitch Data Precautions .....	110
Automatic Reinforcement Stitching.....	46	Saving Stitch Patterns in the Machine's Memory .....	112
Automatic Thread Cutting.....	46	Saving Stitch Patterns to USB Media (Commercially Available).....	113
Locking the Screen .....	47	Saving Stitch Patterns to the Computer.....	114
<b>Chapter 3 Utility Stitches</b> .....	<b>49</b>	Retrieving Stitch Patterns from the Machine's Memory .....	115
SELECTING A UTILITY STITCH.....	50	Retrieving stitch pattern from USB Media.....	116
Selecting a Stitch Pattern.....	51	Retrieving Stitch Patterns from the Computer .....	117
Saving Stitch Settings .....	52		
Using the Sewing Type Selection Key .....	53		
SEWING THE STITCHES .....	54		
Straight Stitches .....	54		
Darts Seams .....	58		
Gathering .....	58		
Flat Fell Seams.....	59		
Pintucks.....	60		
Zigzag Stitches.....	61		
Elastic Zigzag Stitches.....	62		
Overcasting .....	63		
Quilting .....	67		
Blind Hem Stitches .....	71		
Appliqués .....	72		
Shell Tuck Stitching .....	73		
Scalloping.....	73		



<b>Chapter 5 Embroidery</b>	<b>119</b>	<b>Chapter 6 Embroidery Edit</b>	<b>165</b>
BEFORE EMBROIDERING .....	120	AVAILABLE EDITING FUNCTIONS .....	166
Attaching Embroidery Foot “U” .....	121	SELECTING PATTERNS TO EDIT .....	167
Attaching the Embroidery Unit .....	122	Selecting Embroidery Patterns/ Floral Patterns/Frame Patterns/ Baby Lock Exclusive Embroidery Designs .....	167
SELECTING EMBROIDERY PATTERNS .....	124	Alphabet Patterns .....	168
Embroidery Patterns/Floral Patterns/ Baby Lock Exclusive Embroidery Designs .....	125	EDITING PATTERNS.....	170
Alphabet Patterns .....	125	Moving the Pattern .....	171
Frame Patterns.....	126	Rotating the Pattern .....	171
Embroidery Cards.....	127	Changing the Size of the Pattern .....	172
Selecting Patterns from the Machine’s Memory/ USB Media/Computer.....	127	Deleting the Pattern.....	173
VIEWING THE SEWING SCREEN .....	128	Changing the Configuration of Character Patterns....	173
PREPARING THE FABRIC .....	129	Changing the Character Spacing.....	174
Attaching Stabilizer to Fabric.....	129	Changing the Color of Each Character in a Pattern ..	174
Hooping Fabric in the Embroidery Frame .....	130	Changing the Thread Color.....	174
Embroidering Small Fabrics and Fabric Edges .....	132	Creating a Custom Thread Table.....	176
ATTACHING THE EMBROIDERY FRAME..	133	Choosing a Color from the Custom Thread Table ....	177
EDITING THE PATTERN .....	134	After Editing.....	178
Changing the Embroidery Frame Display.....	134	COMBINING PATTERNS.....	179
Changing the Pattern Position.....	135	Editing Combined Patterns.....	179
Rotating the Pattern .....	135	Sewing Combined Patterns .....	182
Changing the Pattern Size.....	136	USING THE MEMORY FUNCTION.....	182
Creating a Horizontal Mirror Image.....	137		
Changing the Stitching Density (Alphabet and Frame Patterns Only) .....	138	<b>Chapter 7 Appendix</b>	<b>183</b>
Changing the Color of Single Characters.....	138	CARE AND MAINTENANCE.....	184
CHECKING THE PATTERN .....	139	Cleaning the LCD .....	184
Checking the Embroidering Position .....	139	Cleaning the Machine Casing .....	184
Previewing the Pattern.....	140	Cleaning the Race .....	184
SEWING AN EMBROIDERING PATTERN ..	141	Cleaning the Bobbin Case .....	185
Sewing Attractive Finishes .....	141	ADJUSTING THE SCREEN .....	186
Sewing Embroidery Patterns .....	142	Screen Visibility Is Low.....	186
Embroidering Appliqué Patterns .....	143	Touch Panel Is Malfunctioning .....	186
ADJUSTMENTS DURING THE EMBROIDERY PROCESS.....	145	TROUBLESHOOTING .....	188
If the Bobbin Runs Out of Thread .....	145	ERROR MESSAGES .....	191
If the Thread Breaks During Sewing .....	146	SPECIFICATIONS.....	197
Restarting from the Beginning.....	147	UPGRADING YOUR MACHINE’S SOFTWARE .....	198
Automatically Resuming Embroidery When the Power Goes Off.....	147	Upgrade Procedure Using USB Media.....	198
Manually Resuming Embroidery After Turning Off the Power.....	148	Upgrade Procedure Using Computer .....	199
Adjusting the Thread Tension .....	149	STITCH SETTING CHART .....	201
Automatic Thread Cutting (End Color Trim).....	150	INDEX .....	207
Changing the Embroidering Speed.....	151		
Changing the Thread Color Display.....	151		
USING THE MEMORY FUNCTION .....	153		
Embroidery Data Precautions .....	153		
Saving Embroidery Patterns in the Machine’s Memory.....	155		
Saving Embroidery Patterns to USB Media (Commercially Available) .....	156		
Saving Embroidery Patterns to the Computer .....	157		
Retrieving Embroidery Patterns from the Machine’s Memory.....	158		
Retrieving Embroidery Patterns from USB Media (Commercially Available).....	159		
Retrieving Embroidery Patterns from the Computer..	160		
EMBROIDERY APPLICATIONS .....	162		
Using a Frame Pattern to Make an Appliqué (1).....	162		
Using a Frame Pattern to Make an Appliqué (2).....	163		



1



2



3



4



5



6



7



# NAMES OF MACHINE PARTS AND THEIR FUNCTIONS

## Machine

### ■ Front View

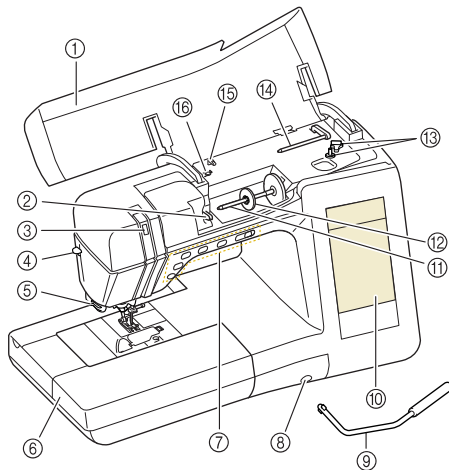

- ① **Top cover**  
Open the top cover to thread the machine and wind the bobbin.
- ② **Thread guide plate**  
Pass the thread around the thread guide plate when threading the upper thread.
- ③ **Thread take-up lever check window**  
Look through the window to check the position of the take-up lever.
- ④ **Needle threader lever**  
Use the needle threader lever when threading the needle automatically.
- ⑤ **Thread cutter**  
Pass the threads through the thread cutter to cut them.
- ⑥ **Flat bed attachment with accessory compartment**  
Store presser feet and bobbins in the accessory compartment of the flat bed attachment. Remove the flat bed attachment when sewing cylindrical pieces such as sleeve cuffs.
- ⑦ **Operation buttons (5 buttons) and sewing speed controller**  
Use these buttons to perform various operations, such as starting sewing and raising or lowering the needle. Slide the sewing speed controller to adjust the sewing speed while using utility stitches.
- ⑧ **Knee lifter slot**  
Insert the knee lifter into the slot.
- ⑨ **Knee lifter**  
Use the knee lifter to raise and lower the presser foot.
- ⑩ **LCD (liquid crystal display)**  
Stitch settings can be viewed and edited, and operations for using the machine can be displayed, and error messages appear in the LCD.
- ⑪ **Spool pin**  
Place a spool of thread on the spool pin.
- ⑫ **Spool cap**  
Use the spool cap to hold the spool in place.
- ⑬ **Bobbin winder**  
Use the bobbin winder when winding the bobbin.
- ⑭ **Supplemental spool pin**  
Use this spool pin to wind the bobbin thread while sewing or to sew with the twin needle.
- ⑮ **Thread guide**  
Pass the thread through this thread guide when winding the bobbin thread.
- ⑯ **Bobbin winding pretension disk and guide**  
Pass the thread through the pretension disk and guide when winding the bobbin thread.

### ■ Right-side/Rear View

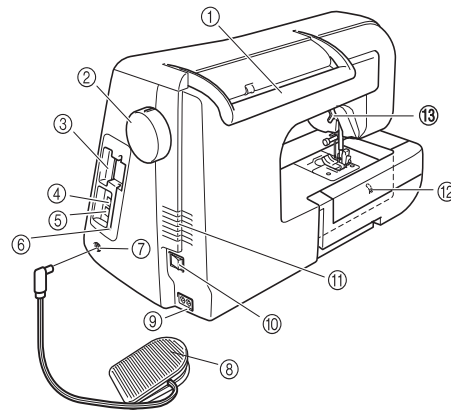

- ① **Handle**  
When transporting the machine, carry it by this handle.
- ② **Handwheel**  
Turn the handwheel toward you to sew one stitch or to raise or lower the needle.
- ③ **Embroidery card slot**  
Insert the embroidery cards (sold separately) into the embroidery card slot.
- ④ **USB port connector for media**  
In order to send patterns from/to USB media, plug the USB media into the USB port connector.
- ⑤ **USB port connector for computer**  
In order to import/export patterns between a computer and the machine, plug the USB cable into the USB port connector.
- ⑥ **Touch pen holder**  
Use the touch pen holder to hold the touch pen when it is not being used.
- ⑦ **Foot controller jack**  
Insert the plug on the end of the foot controller cord into the foot controller jack.
- ⑧ **Foot controller with retractable cord**  
Press the foot controller to control the speed of the machine.
- ⑨ **Jack connector**  
Insert the power cord into the connector jack.
- ⑩ **Main power switch**  
Use the main power switch to turn the machine ON and OFF.
- ⑪ **Air vent**  
Do not cover the air vent while the sewing machine is being used.
- ⑫ **Feed dog position switch**  
Use the feed dog position switch to lower the feed dogs.
- ⑬ **Presser foot lever**  
Raise and lower the presser foot lever to raise and lower the presser foot.

## Needle and Presser Foot Section

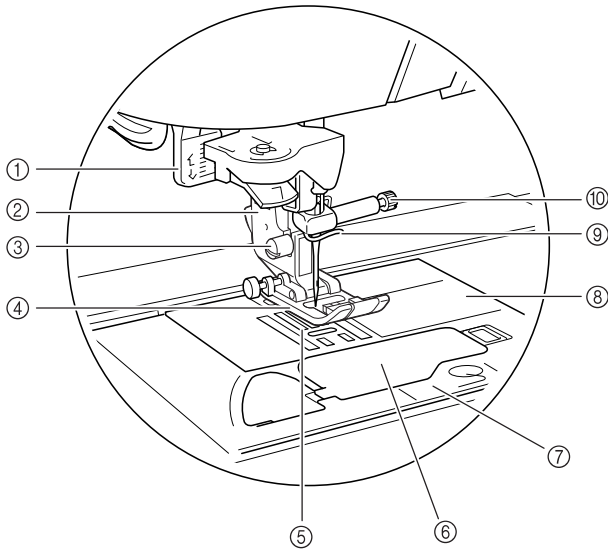

- ① **Buttonhole lever**  
Lower the buttonhole lever when sewing buttonholes and bar tacks.
- ② **Presser foot holder**  
The presser foot is attached to the presser foot holder.
- ③ **Presser foot holder screw**  
Use the presser foot holder screw to hold the presser foot holder in place.
- ④ **Presser foot**  
The presser foot consistently applies pressure to the fabric as it is sewn. Attach the appropriate presser foot for the selected stitch.
- ⑤ **Feed dogs**  
The feed dogs feed the fabric in the sewing direction.
- ⑥ **Bobbin cover**  
Open the bobbin cover to insert the bobbin.
- ⑦ **Needle plate cover**  
Remove the needle plate cover to clean the bobbin case and race.
- ⑧ **Needle plate**  
The needle plate is marked with guides to help sew straight seams.
- ⑨ **Needle bar thread guide**  
Pass the upper thread through the needle bar thread guide.
- ⑩ **Needle clamp screw**  
Use the needle clamp screw to hold the needle in place.

## Embroidery Unit

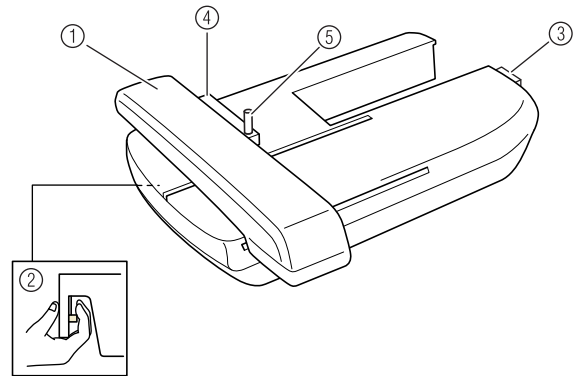



- ① **Carriage**  
The carriage moves the embroidery frame automatically when embroidering.
- ② **Release button (located under the embroidery unit)**  
Press the release button to remove the embroidery unit.
- ③ **Embroidery unit connector**  
Insert the embroidery unit connector into the connection port to attach the embroidery unit.
- ④ **Embroidery frame holder**  
Attach the embroidery frame to the embroidery frame holder to hold the frame in place.
- ⑤ **Frame-securing lever**  
Press down the frame-securing lever to secure the embroidery frame.

### CAUTION

- After the embroidery frame is set in the frame holder, be sure the frame-securing lever is correctly lowered.

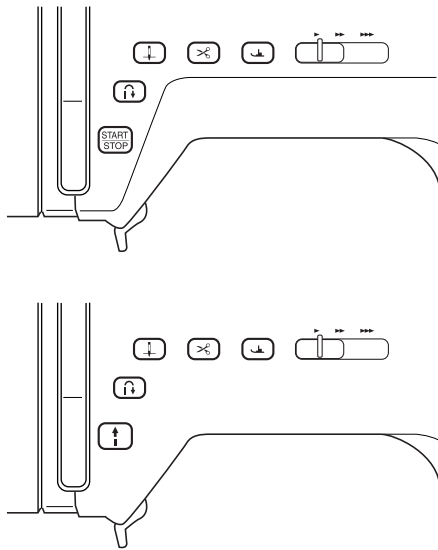
## Operation Buttons



① **“Start/Stop” button**  

When this button is pressed, the machine sews a few stitches at a low speed, then begins sewing at the speed set by the sewing speed controller. Press this button again to stop sewing. This button lights up in a different color depending on the machine's operating condition.

- Green: The machine is ready to sew or is sewing.
- Red: The machine cannot sew.

② **“Reverse/Reinforcement Stitch” button** 

This button is used to sew reinforcement stitches at the beginning and end of stitching. When this button is pressed, the machine sews 3 to 5 stitches in the same spot, then stops automatically. For straight and zigzag stitch patterns that take reverse stitches, the machine sews reverse stitches (stitches sewn in the opposite direction) at low speed only while the “Reverse/Reinforcement Stitch” button is held down.

③ **“Needle Position” button** 

Use this button to change the sewing direction or for detailed sewing in small areas. Press this button to raise or lower the needle position. Press this button twice to sew a single stitch.

④ **“Thread Cutter” button** 

Press this button after sewing to automatically trim the excess thread.

⑤ **“Presser Foot Lifter” button** 

Press this button to lower the presser foot and apply pressure to the fabric. Press this button again to raise the presser foot.

⑥ **Sewing speed controller** 

Slide the sewing speed controller to the left or right to adjust the sewing speed. Slide the controller to the left to sew at lower speeds. Slide the controller to the right to sew at higher speeds. Beginners should sew at a lower speed until they become familiar with the machine.

### CAUTION

- Do not press the “Thread Cutter” button after the threads have already been cut. Otherwise, the needle may break, the threads may become tangled, or damage to the machine may occur.

## Included Accessories

The accessories are stored in the flat bed attachment. Open the flat bed attachment as shown below.

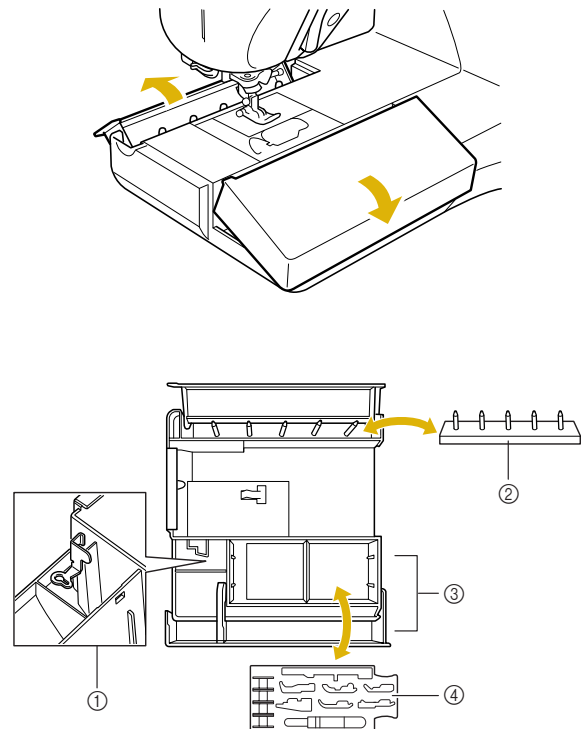

- ① **Embroidery foot “U” storage space**
- ② **Bobbin stand**  
(Place the bobbins on the pins to store them.)
- ③ **Storage space**
- ④ **Presser foot storage tray**  
(Store presser feet marked A, G, I, J, M, N, and R.)

Included accessories 33,34,35 are contained in the embroidery unit carrying case. To open the embroidery unit carrying case, raise the lock and unlock the latch out of the position. To hook the latches and securely close the case, position the latch on the case and lower the lock till it snaps.

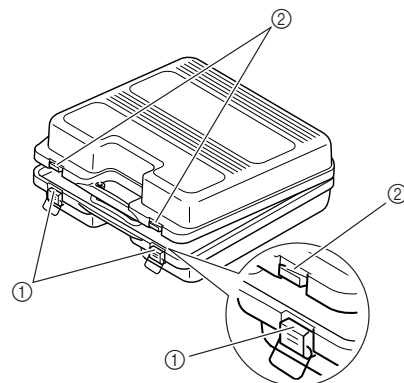

- ① **Latches**
- ② **Locks**

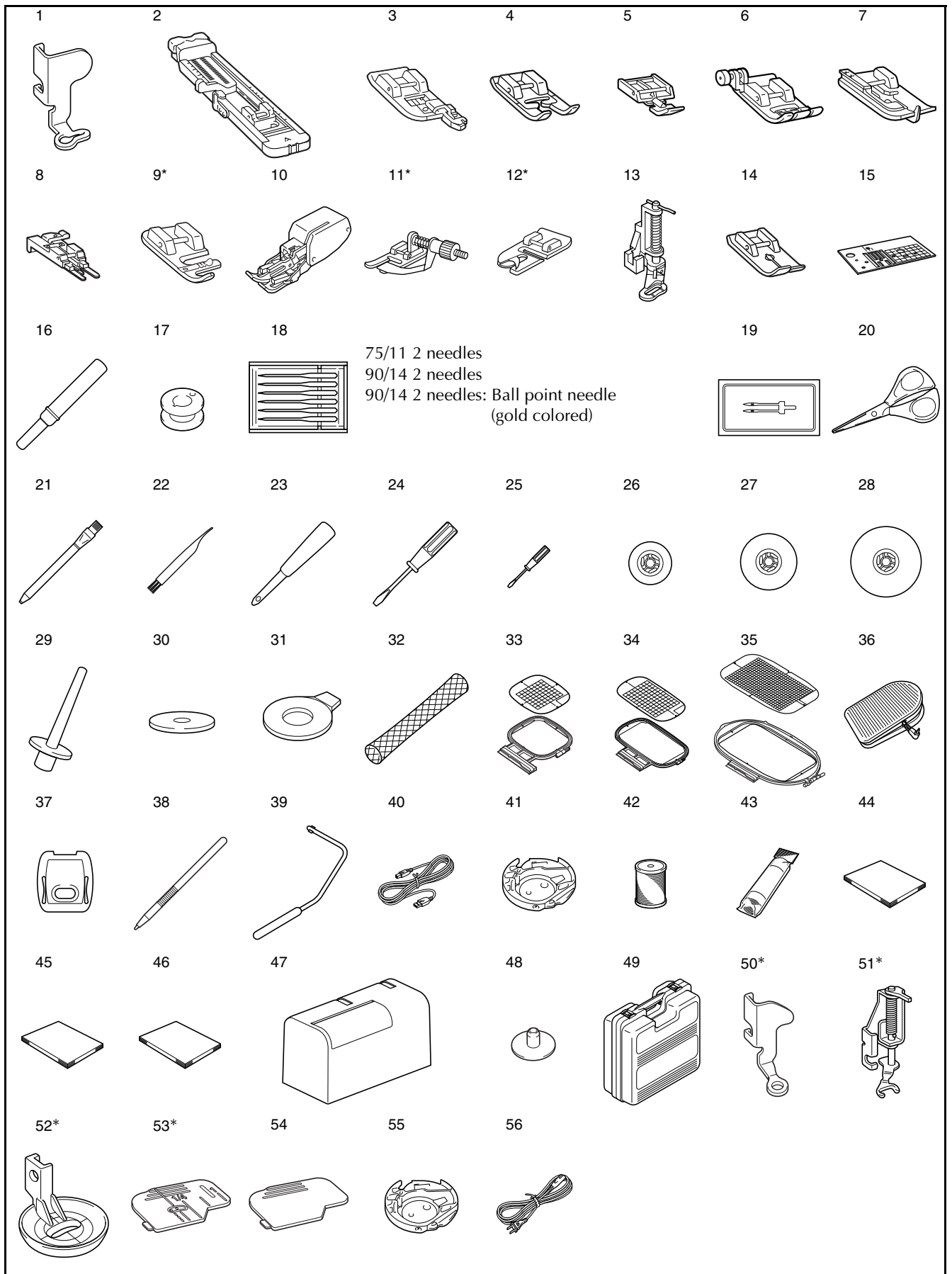

No.	Part Name	Part Code
1	Embroidery foot "U"	XD0313-051
2	Buttonhole foot "A"	X57789-151
3	Overcasting foot "G"	XC3098-051
4	Monogramming foot "N"	X53840-351
5	Zipper foot "I"	X59370-051
6	Zigzag foot "J" (on machine)	XC3021-051
7	Blind stitch foot "R"	X56409-051
8	Button fitting foot "M"	130489-001
9	Cording foot (3 cord guide)*	XA6871-001
10	Walking foot	X59816-104
11	Blind stitch foot (with guide)*	XA0059-001
12	Narrow hemmer foot*	184600-001
13	Free-motion quilting foot	XA4322-001
14	Straight stitch foot	XD0826-051
15	Straight stitch needle plate	XC8362-051
16	Seam ripper	X54243-051
17	Bobbin × 10	X52800-150
18	Needle set	X58358-051
19	Twin Needle	X59296-151
20	Scissors	XC1807-121
21	Chalk pen	184944-001
22	Cleaning brush	X59476-051
23	Eyelet punch	135793-001
24	Screwdriver (large)	XC8349-021
25	Screwdriver (small)	X55468-021
26	Spool cap (small)	130013-154
27	Spool cap (medium) × 2	X55260-153
28	Spool cap (large)	130012-054
29	Vertical spool pin	XC8619-051
30	Spool felt	X57045-051
31	Disc-shaped screwdriver	XC1074-051
32	Spool net	XA5523-050
33	Embroidery frame set (medium) 10 cm (H) × 10 cm (W) (4 inches (H) × 4 inches (W))	EF74: Frame EF78: Embroidery sheet
34	Embroidery frame set (large) 18 cm (H) × 13 cm (W) (7 inches (H) × 5 inches (W))	EF75: Frame EF79: Embroidery sheet
35	Embroidery frame set (extra large) 26 cm (H) × 16 cm (W) (10-1/4 inches (H) × 6-1/4 inches (W))	EF81: Frame EF86: Embroidery sheet
36	Foot controller	XC8028-051
37	Embroidery needle plate cover	XA9939-051
38	Touch pen (stylus)	XA9940-051
39	Knee lifter	XA6941-052
40	USB cable	XD0745-051
41	Alternate bobbin case (no color on the screw)	XC8167-451
42	Embroidery bobbin thread	BBT-W
43	Stabilizer material	X81176-001
44	Instruction and Reference Guide	XE6350-001
45	Quick Reference Guide	XE6351-001
46	Instruction and Reference Guide Addendum	XE6352-001
47	Hard case	XC9640-152
48	Bobbin center pin (for pre-wound bobbin)	XD0835-051
49	Embroidery unit carrying case	BLG-EUC
50	Free motion quilting foot "C"*	XE0765-101

No.	Part Name	Part Code
51	Free motion open toe quilting foot "O"*	XE0767-001
52	Free motion echo quilting foot "E"*	XE0766-001
53	Bobbin cover (with mark) (on machine)*	XE0715-001
54	Bobbin cover	XD1645-021
55	Bobbin case (green marking on the screw) (on machine)	XC3153-251
56	Power cord	XC6052-051

\* See Instruction and Reference Guide Addendum for detailed instruction.



**Memo**

(For U.S.A. only)

Foot controller: Model S

This foot controller can be used with this machine model BLL2.



**Memo**

- Always use accessories recommended for this machine.
- The screw for the presser foot holder is available through your authorized retailer (part code: XA4813-051).
- See the additional accessories guide.
- This operation manual and the foot controller can be stored in the machine's hard case.

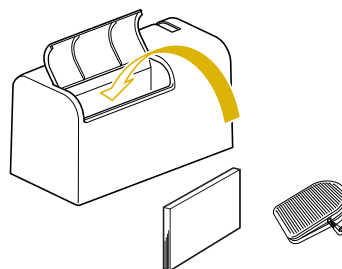

## Options

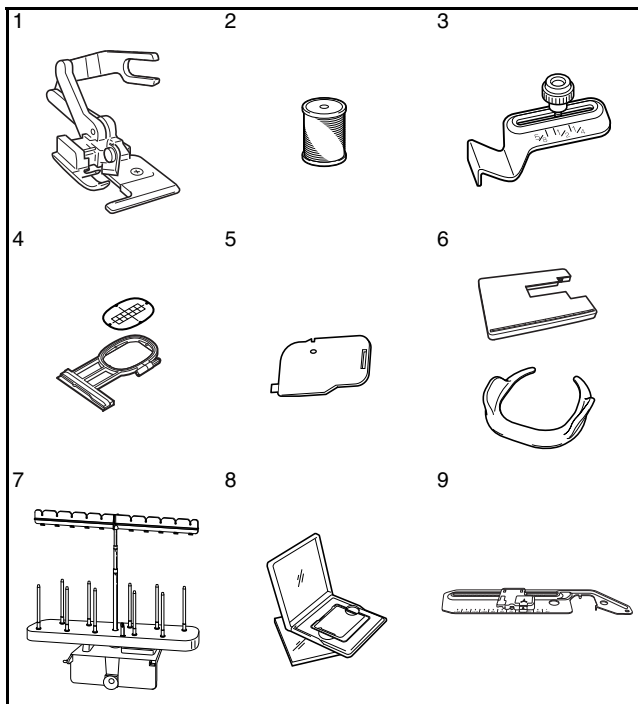

No.	Part Name	Part Code
1	Side cutter foot	XC3923-001
2	Embroidery bobbin thread (White)	BBT-W
	Embroidery bobbin thread (Black)	BBT-B
3	Seam guide	BLG-SG
4	Embroidery frame set (small)	
	2 cm (H) × 6 cm (W) (1 inch (H) × 2-1/2 inches (W))	EF73: Frame EF77: Embroidery sheet
5	Cord guide bobbin cover (with single hole)	XC8449-051
6	Table and free motion grip	BLG-ET
7	Spool stand	BLG-TS
8	Embroidery card	
9	Circular attachment	BLCSA



### Memo

- All specifications are correct at the time of printing.
- Please be aware that some specifications may change without notice.



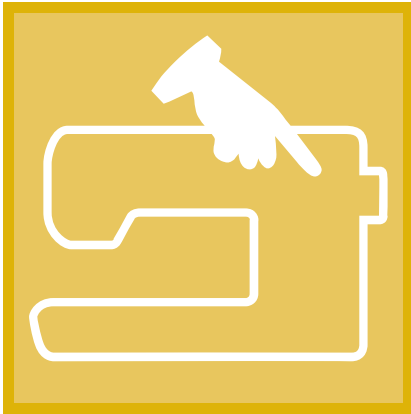

# Chapter 1

## Getting Ready

<b>TURNING THE MACHINE ON/OFF.....</b>	<b>16</b>
<b>LCD SCREEN.....</b>	<b>17</b>
■ Display Precautions.....	17
■ Key Functions.....	18
Using the Machine Setting Mode Key.....	20
Using the Machine Operation Mode Key.....	22
■ Contents of Each Category.....	22
Using the Pattern Explanation Key.....	23
<b>LOWER/UPPER THREADING.....</b>	<b>24</b>
Winding the Bobbin.....	24
■ Using the Supplemental Spool Pin.....	24
■ Winding the Bobbin Using the Spool Pin.....	26
Setting the Bobbin.....	27
Pulling Up the Bobbin Thread.....	28
Upper Threading.....	29
Using the Twin Needle.....	32
<b>CHANGING THE PRESSER FOOT.....</b>	<b>34</b>
Removing the Presser Foot.....	34
Attaching the Presser Foot.....	34
<b>CHANGING THE NEEDLE.....</b>	<b>35</b>
■ Checking the Needle.....	35
■ About the Needle.....	37
■ Fabric/Thread/Needle Combinations.....	37

# TURNING THE MACHINE ON/OFF

## ⚠ WARNING

- Use only regular household electricity as the power source. Using other power sources may result in fire, electric shock, or damage to the machine.
- Turn the main power to OFF and remove the plug in the following circumstances:  
When you are away from the machine  
After using the machine  
When the power fails during use  
When the machine does not operate correctly due to a bad connection or a disconnection  
During electrical storms

## ⚠ CAUTION

- Do not use extension cords or multi-plug adapters with many other appliances plugged in to them. Fire or electric shock may result.
- Do not touch the plug with wet hands. Electric shock may result.
- When unplugging the machine, always turn the main power to OFF first. Always grasp the plug to remove it from the outlet. Pulling on the cord may damage the cord, or lead to fire or electric shock.
- Do not allow the power cord to be cut, damaged, modified, forcefully bent, pulled, twisted, or bundled. Do not place heavy objects on the cord. Do not subject the cord to heat. These things may damage the cord, or cause fire or electric shock. If the cord or plug is damaged, take the machine to your authorized retailer for repairs before continuing use.
- Unplug the power cord if the machine is not to be used for a long period of time. Otherwise, a fire may result.
- When leaving the machine unattended, either the main switch of the machine should be turned to OFF or the plug must be removed from the socket-outlet.
- When servicing the machine or when removing covers, either the machine or the electrical set must be unplugged.
- For U.S.A. only  
This appliance has a polarized plug (one blade wider than the other). To reduce the risk of electrical shock, this plug is intended to fit in a polarized outlet only one way.  
If the plug does not fit fully in the outlet, reverse the plug. If it still does not fit, contact a qualified electrician to install the proper outlet. Do not modify the plug in any way.

- 1** Insert the power cord into the power cord jack connector, then insert the plug into a wall outlet.

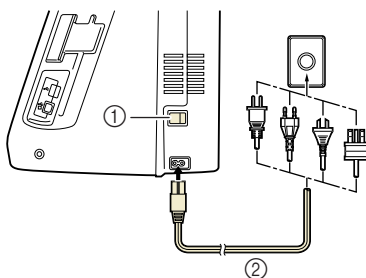

- ① Main power switch  
② Power cord

- 2** Turn the main power switch to "I" to turn ON the machine.

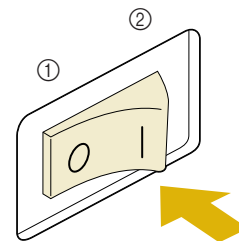

- ① OFF  
② ON

- 3** Turn the main power switch to "O" to turn OFF the machine.

# LCD SCREEN

## ■ Display Precautions

- Only touch the display with your finger or the touch pen included with the machine. Do not use a mechanical pencil, screwdriver or any other hard or sharp objects. In addition, do not press the display with extreme pressure, otherwise damage to the display may result.
- All or part of the display may sometimes become darker or lighter due to fluctuations in the surrounding temperature or other changes in the environment. This is not a sign of a malfunction. If the display is difficult to read, adjust its brightness (see page 21).
- The display may be dark immediately after the machine is turned on. This is a normal characteristic of the backlight and is not a sign of a malfunction. After approximately 10 minutes, the display should reach its normal level of brightness.
- If you are not directly facing the display, the colors may be distorted or the screen may be difficult to read. This is a normal characteristic of the display and is not a malfunction. Be sure to sit in front of the display while using it.

When the machine is turned on, the opening screen appears. The machine can be set so that the opening screen is not displayed (see page 21).

Lightly press the display with your finger. Depending on the setting either, "1-01 Straight stitch (Left)" or "1-03 Straight stitch (Middle)" is automatically selected (see page 20).



### Memo

It may take some time until the opening screen appears. This is not a sign of a malfunction.

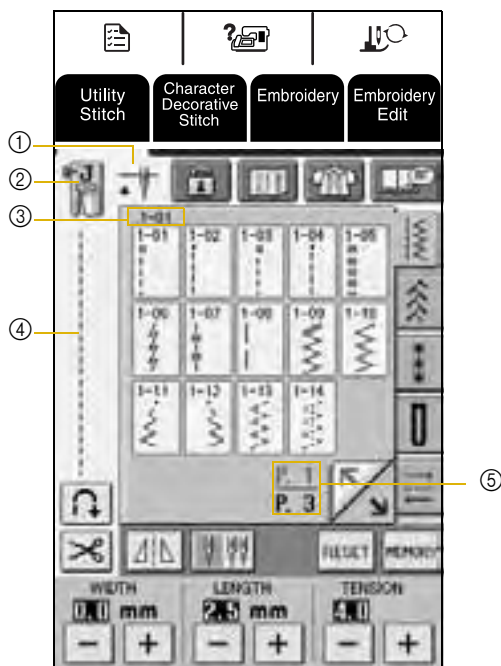

- ① Shows whether the machine is set for a single needle or twin needle, and the needle position when the machine is stopped. The desired needle position can be set (see page 20).

For a single needle



Single needle/down position



Single needle/up position

For a twin needle



Twin needle/down position



Twin needle/up position

- ② Presser foot code  
Attach the indicated presser foot before sewing.
- ③ Shows the number for the selected stitch (only for utility stitches).
- ④ Shows a preview of the selected stitch.
- ⑤ Shows the current page number and the total number of pages available.





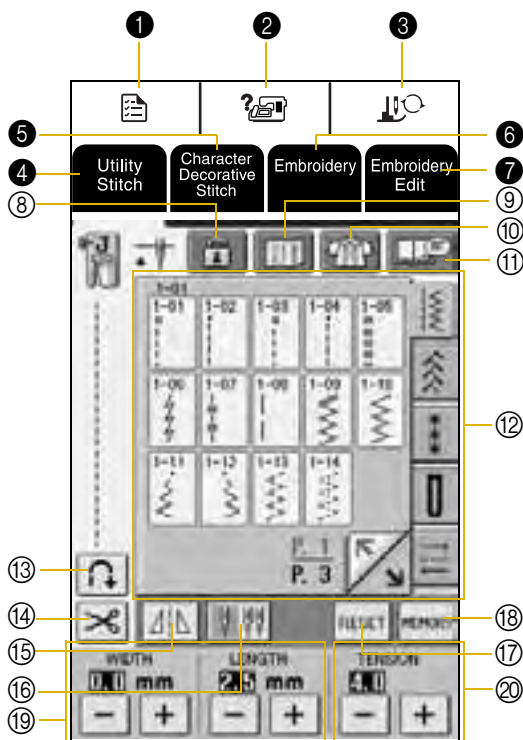

## ■ Key Functions



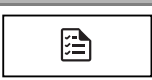



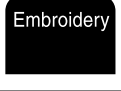
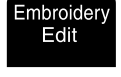













With your finger or the touch pen, press a key at the top of the display (  ) to change the screen that is displayed.



Operation panel

No.	Key	Name	Function	Page
1		Machine setting mode key	Press this key to change the needle stop position, turn the buzzer on/off, adjust the pattern or screen, and change other machine settings.	20
2		Machine operation mode key	Press this key to see descriptions for upper threading, winding the bobbin, changing the presser foot, and other operations for using the machine.	22
3		Presser foot/Needle exchange key	Press this key when changing the needle or presser foot. Pressing this key locks all keys and operation buttons so that parts can safely be changed. Press this key again to unlock the keys and buttons. When operations are displayed, the screen for the presser foot/needle replacement mode is not displayed.	34,35
4		Utility stitch key	Press this key to select a straight stitch, zigzag stitch, buttonhole, blind hem stitch, or other stitch (utility stitch) commonly used in garment sewing.	50
5		Character/Decorative stitch key	Press this key to select character or decorative stitch patterns.	94
6		Embroidery key	Press this key to sew embroidery.	124
7		Embroidery edit key	Press this key to combine embroidery patterns. By editing embroidery patterns, you can create original emblems and name tags.	167

## Screen

No.	Key	Name	Function	Page
⑧		Screen lock key	Press this key to lock the screen. When the screen is locked, the various settings, such as the stitch width and stitch length, are locked and cannot be changed. Press this key again to unlock the settings.	47
⑨		Image key	Press this key to display an enlarged image of the selected stitch pattern.	51
⑩		Sewing type selection key	Press this key when you need help selecting the appropriate stitch pattern for the sewing application and when you need instructions on how to sew the selected stitch pattern. This key is very helpful for beginners.	53
⑪		Pattern explanation key	Press this key to see how the selected stitch pattern can be used.	23
⑫		Stitch selection display	Press the key for the stitch pattern that you want to sew. Press one of the  keys to change the pattern selection screen.	50
⑬		Automatic reinforcement stitch key	Press this key to select the automatic reinforcement stitching (reverse stitching) setting. If you select this setting before sewing, the machine will automatically sew reinforcement stitches at the beginning and end of stitching (depending on the selected stitch pattern, reverse stitches may be sewn). Press this key again to cancel the setting.	46
⑭		Automatic thread cutting key	Press this key to select the automatic thread cutting setting. If you select this setting before sewing, the machine will automatically sew reinforcement stitches (or reverse stitches, depending on the selected stitch) and trim the threads when the "Reverse/Reinforcement Stitch" button is pressed. Press this key again to cancel the setting.	46
⑮		Mirror image key	Press this key to create a mirror image of the selected stitch pattern. • If this key appears as  , it cannot be used.	51
⑯		Needle mode selection key (single/twin)	Before sewing with the twin needle, press this key to select the setting for twin needle sewing. Each time this key is pressed, the setting switches between that for single needle sewing and twin needle sewing. • If this key appears as  , it cannot be used.	32
⑰		Reset key	Press this key to return the selected stitch pattern's saved settings to the original settings.	52
⑱		Manual memory key	Change the stitch pattern settings (zigzag width and stitch length, thread tension, automatic thread cutting or automatic reinforcement stitching, etc.), then save them by pressing this key.	52
⑲		Stitch width and stitch length keys	Shows the stitch width (zigzag width) and the stitch length settings of the currently selected stitch pattern. Press  or  to adjust the stitch width and stitch length settings. • If  appears, the setting cannot be adjusted.	44
⑳		Thread tension keys	Shows the thread tension setting of the currently selected stitch pattern. The thread tension is usually set automatically. Press  or  to adjust the thread tension setting.	45



## Using the Machine Setting Mode Key

Press  to change the needle stop position, turn the buzzer on/off, adjust the pattern or screen, and change other basic machine settings.

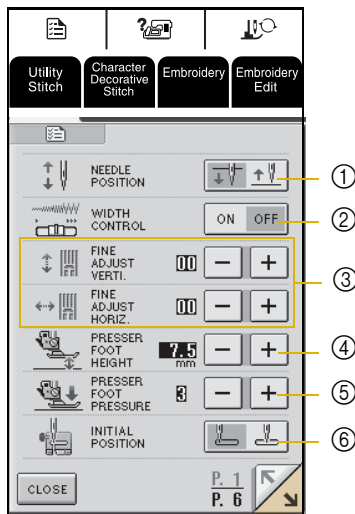

- ① Select whether the needle stops in the raised or lowered position when the machine is stopped.
- ② Select whether to use the sewing speed controller or to adjust the zigzag width (see page 69).
- ③ Make adjustments to the character and decorative stitch patterns (see page 99).
- ④ Adjust the presser foot height (select the height of the presser foot when the presser foot is raised) (see page 43).
- ⑤ Adjust the presser foot pressure between 1 (weak) and 4 (strong).
  - \* The higher the number, the greater the pressure will be. Set the pressure to 3 for normal sewing.
- ⑥ Select whether “1-01 Straight stitch (Left)” or “1-03 Straight stitch (Middle)” is the utility stitch that is automatically displayed when utility stitch is selected.

\* Press  to display the next page.

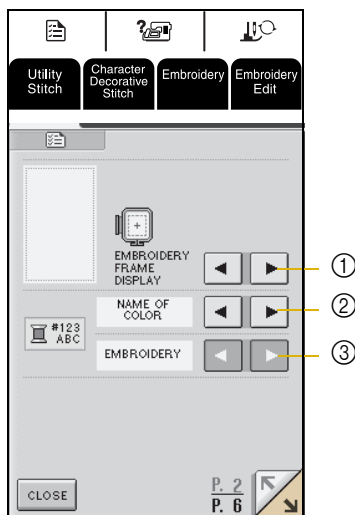

- ① Select from among 10 embroidery frame displays (see page 134).
- ② Select whether the thread color name, thread color number or sewing time appears for the thread color display in the embroidery screen (see page 151).
- ③ Select the thread brand available when selecting a thread color number in the thread color display of the Embroidery screen. (see page 151).

\* Press  to display the next page.

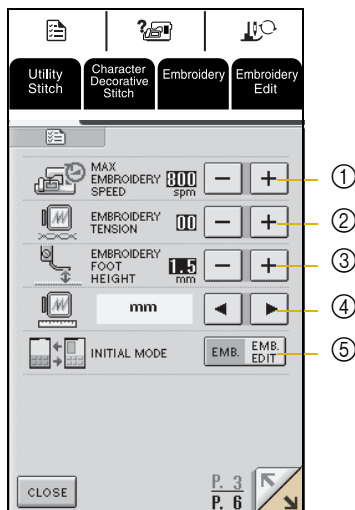

- ① Adjust the maximum embroidering speed (see page 151).
- ② Adjust the thread tension for embroidering (see page 149).
- ③ Adjust the height of embroidery foot “U” (see page 129).
- ④ Select the units (mm/inch) for displaying distances and the sizes of embroidery patterns.
- ⑤ Select the initial screen (Embroidery/Embroidery Edit) when the embroidery unit is installed.

\* Press  to display the next page.

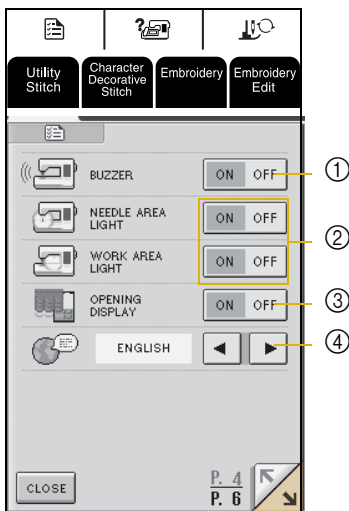

- ① Turn on/off the buzzer (see page 196).
- ② Turn on/off the needle area and work area lights.
- ③ Select whether or not the opening screen appears when the machine is turned on.
- ④ Select one of the three display languages: [English], [French], [Spanish]

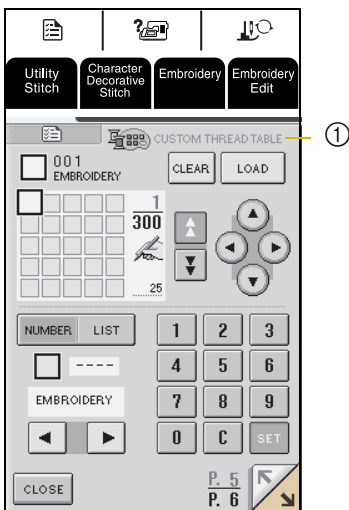

\* Press  to display the next page.

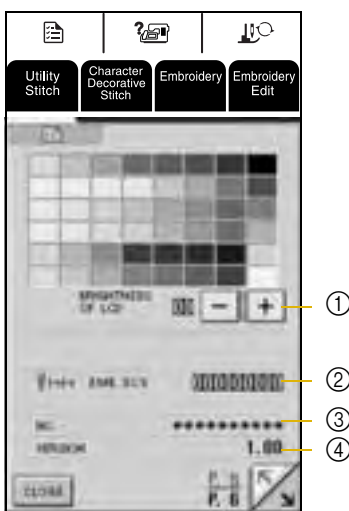

- ① Customize the thread color numbers (see page 176).

\* Press  to display the next page.



- ① Adjust the brightness of the LCD.
  - \* Press  to make the screen lighter.
  - \* Press  to make the screen darker.
- ② Display the service count of embroidery stitches. The service count is a reminder to take your machine in for regular servicing. (Contact your authorized retailer for details.)
- ③ Shows the product identification number for this machine.
- ④ Shows the version of the software installed on this machine.



**Memo**































The latest version of software is installed in your machine. Check with your local authorized Baby Lock retailer or at [www.babylock.com](http://www.babylock.com) for notification of available updates (see page 198).

## Using the Machine Operation Mode Key

Basic machine operations and other information based on the contents of this Operation Manual are stored in this machine.

Press  to open the screen shown below. Six categories are displayed at the top of the screen. Press a key to see more information about that category.

### ■ Contents of Each Category

Names of Machine Parts and Their Functions	Sewing Basics	Troubleshooting
 <ul style="list-style-type: none"> <li> Presser foot lever</li> <li> Sewing speed controller</li> <li> Handwheel</li> <li> Feed dog position switch</li> <li> Flat bed attachment with accessory compartment</li> <li> Knee lifter</li> <li> Foot controller</li> </ul>	 <ul style="list-style-type: none"> <li> Upper threading</li> <li> Bobbin winding</li> <li> Changing the needle</li> <li> Changing the presser foot</li> <li> Setting the bobbin</li> </ul>	
Main Buttons	Basic Embroidering Operations	Maintenance
 <ul style="list-style-type: none"> <li> "Thread Cutter" button</li> <li> "Presser Foot Lifter" button</li> <li> "Start/Stop" button</li> <li> "Reverse/Reinforcement Stitch" button</li> <li> "Needle Position" button</li> </ul>	 <ul style="list-style-type: none"> <li> Attaching iron-on stabilizers (backing) to the fabric</li> <li> Inserting the fabric</li> <li> Attaching &amp; removing the embroidery frame</li> <li> Attaching the embroidery unit</li> <li> Attaching embroidery foot "U"</li> <li> Correct stabilizer to use</li> </ul>	 <ul style="list-style-type: none"> <li> Cleaning the race and bobbin case</li> </ul>



**Example:** Displaying information about upper threading

1 Press  .

2 Press  .

→ A list of basic operations appears in the lower half of the screen.

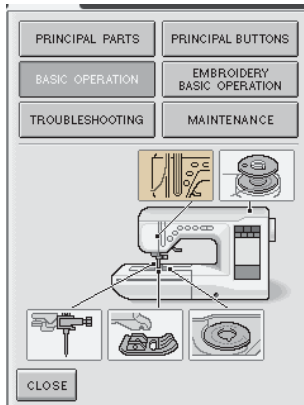

3 Press  (upper threading).

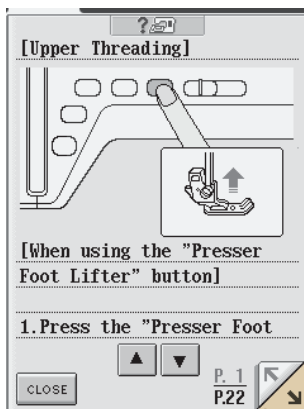

→ The instructions for threading the machine appear.

4 Press  to view the next page.





\* Press  or  to view additional information for that page.

5 When you are finished with the instructions, press  .

## Using the Pattern Explanation Key



To learn more about the uses for a stitch pattern, select the stitch, and then press  to see a description of the selected stitch.

**Example:** Displaying information on the use for  .

1 Select  , and then press  .

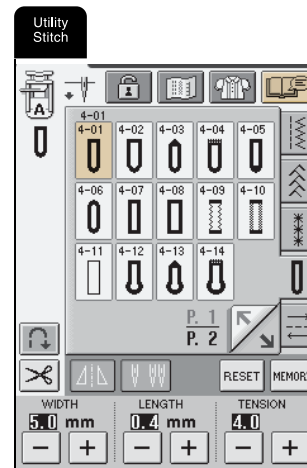

→ Uses for  appear.

2 When you are finished with the instructions, press  .

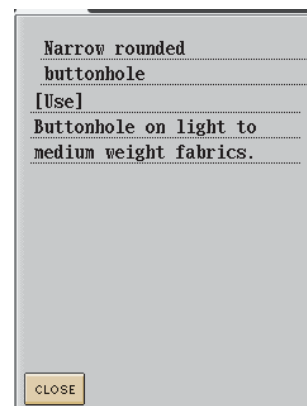

1

Getting Ready

# LOWER/UPPER THREADING

## Winding the Bobbin

This section describes how to wind thread onto a bobbin. With this machine, you can use the supplemental spool pin to wind the bobbin while sewing using the main spool pin.

### CAUTION

- The included bobbin was designed specifically for this sewing machine. If bobbins from other models are used, the machine will not operate correctly. Use only the included bobbin or bobbins of the same type (part code: X52800-150).

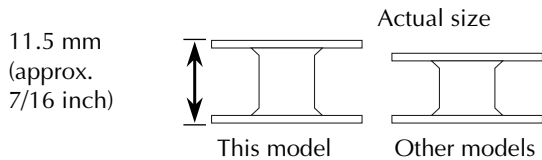

### Using the Supplemental Spool Pin

While sewing embroidery, the bobbin can conveniently be wound.

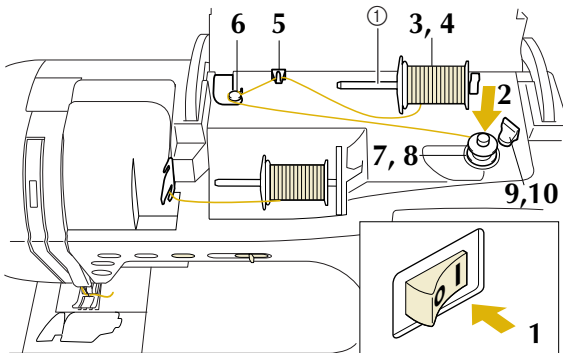

① Supplemental spool pin

- Turn on the machine, and then open the top cover.
- Align the groove in the bobbin with the spring on the bobbin winder shaft, and then set the bobbin on the shaft.

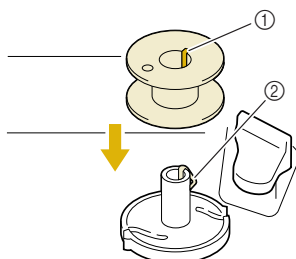

① Groove in bobbin  
② Spring on bobbin winder shaft

- Set the supplemental spool pin in the “up” position.

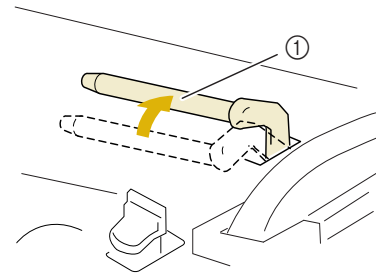

① Supplemental spool pin

- Place the spool of thread on the supplemental spool pin so that the thread unwinds from the front. Then, slide the spool cap as far as possible onto the supplemental spool pin to secure the thread spool.

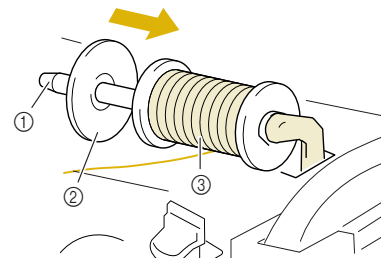

① Supplemental spool pin  
② Spool cap  
③ Thread spool

### CAUTION

- If the thread spool and/or spool cap are set incorrectly, the thread may tangle on the spool pin and cause the needle to break.
- Use the spool cap (large, medium, or small) that is closest in size to the thread spool. If a spool cap smaller than the thread spool is used, the thread may become caught in the slit on the end of the spool.

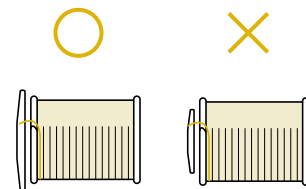

**Note**

When using cross-wound thread on a thin spool, use the small spool cap, and leave a small gap between the cap and the thread spool.

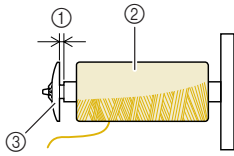

- ① Gap
- ② Cross-wound thread
- ③ Spool cap (small)

**5** While holding the thread from the spool in your right hand, hold the end of the thread with your left hand, and then pass the thread through the thread guide.

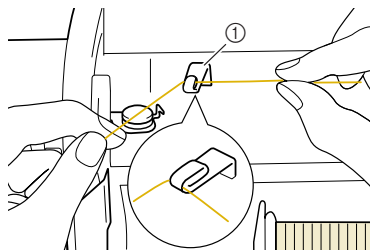

- ① Thread guide

**6** Pass the thread under the pin on the bobbin winding pretension disk and guide, and then pass it around the pretension disk.

\* Make sure that the thread passes under the pretension disk.

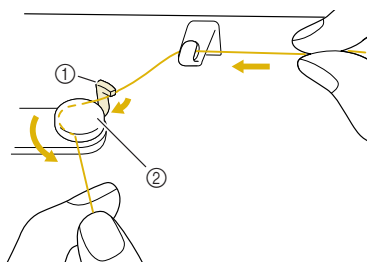

- ① Pin
- ② Pretension disk

**7** Wind the thread clockwise around the bobbin four or five times.

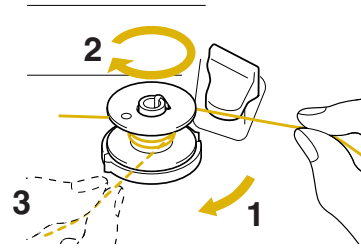

**Note**

- Make sure that the thread between the spool and the bobbin is pulled tight.
- Be sure to wind the thread clockwise around the bobbin, otherwise the thread will become wrapped around the bobbin winder shaft.

**8** Pass the end of the thread through the guide slit in the bobbin winder seat, and then pull the thread to the right to cut it with the cutter.

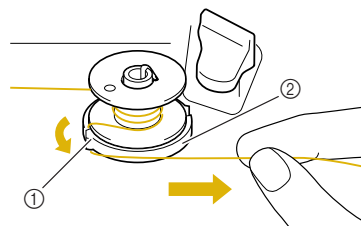

- ① Guide slit
- ② Bobbin winder seat

**CAUTION**

- Be sure to follow the process described. If the thread is not cut with the cutter, and the bobbin is wound, when the thread runs low, it may tangle around the bobbin.

**9** Slide the bobbin holder to the left until it snaps into place.

\* When the bobbin holder is set to the left, it works as a switch to make the bobbin wind automatically.

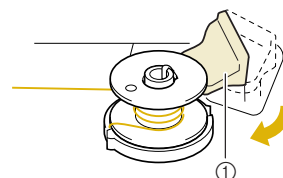

- ① Bobbin holder (switch)

→ The bobbin stops spinning automatically when it is full, and the bobbin holder returns to its original position.



Getting Ready  
1

**10** Cut the thread, and then remove the bobbin.

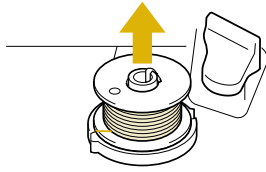

**Note**

When removing the bobbin, pull up only on the bobbin. Do not pull on the bobbin winder seat, otherwise it may become loose, resulting in damage to the machine.

**CAUTION**

- Winding the bobbin thread improperly may cause the thread tension to loosen, breaking the needle and possibly resulting in injury.

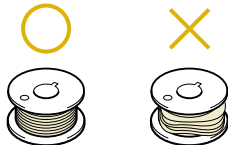

**Winding the Bobbin Using the Spool Pin**

The main spool pin cannot be used to wind the bobbin while sewing. For details, see “Using the Supplemental Spool Pin” on page 24.

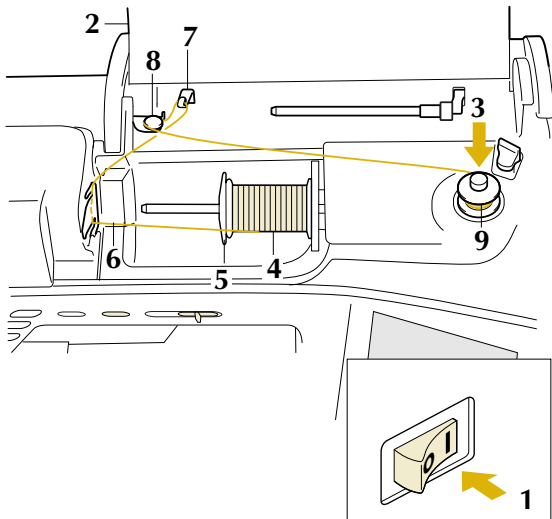

**1** Turn on the machine.

**2** Open the top cover.

**3** Align the groove in the bobbin with the spring on the bobbin winder shaft, and then slide the bobbin onto the shaft.

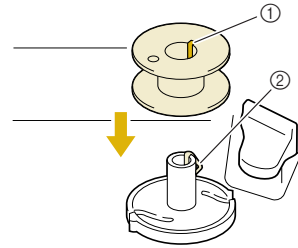

- ① Groove in bobbin
- ② Spring on bobbin winder shaft

**4** Pivot the spool pin so that it angles upward, and then place the spool of thread on the spool pin.

\* Make sure that the thread unwinds from the front.

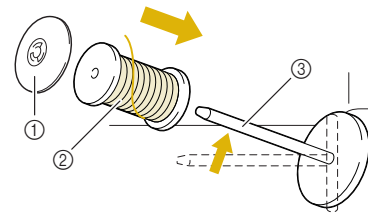

- ① Spool cap
- ② Thread spool
- ③ Spool pin

**5** Slide the spool cap as far as possible onto the spool pin, and then return the spool pin to its original position.

**6** While holding the thread from the spool with both hands, pull the thread through the lower notch in the thread guide plate, then through the upper notch.

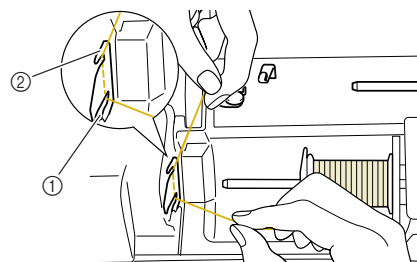

- ① Lower notch in the thread guide plate
- ② Upper notch in the thread guide plate

**7** Pass the thread through the thread guide.

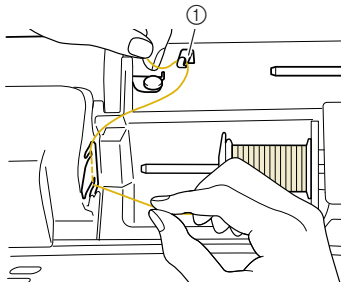

① Thread guide

**8** Pass the thread under the pin on the bobbin winding pretension disk and guide, and then pass it around the pretension disk.

\* Make sure that the thread passes under the pretension disk.

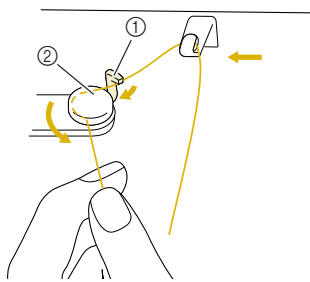

① Pin  
② Pretension disk

**9** Follow steps 7 through 10 on page 25.

### Setting the Bobbin

This section describes how to set a bobbin wound with thread into the machine. You can begin sewing without pulling up the bobbin thread. If you wish to pull up the bobbin thread, for example, when sewing gathers, follow the procedure described in the next section.

#### CAUTION

- Use a bobbin thread that has been correctly wound. Otherwise, the needle may break or the thread tension will be incorrect.

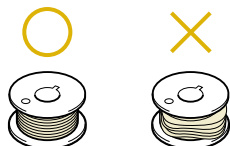

**1** Press the “Presser Foot Lifter” button to raise the presser foot.

**2** Slide the bobbin cover latch to the right, and then remove the bobbin cover.

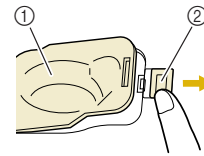

① Bobbin cover  
② Latch

**3** Hold the bobbin with your right hand and hold the end of the thread with your left hand.

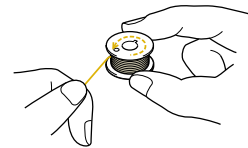

**4** Insert the wound bobbin into the bobbin case so that the thread unwinds in the direction of the arrow.

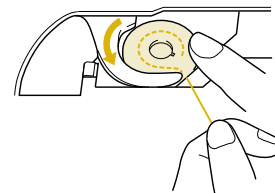

#### CAUTION

- Be sure to hold down the bobbin with your finger and unwind the bobbin thread correctly. Otherwise, the thread may break or the thread tension will be incorrect.

**5** Lightly hold down the bobbin with your right hand, and then, while slightly pulling the thread with your left hand, guide it through the groove.

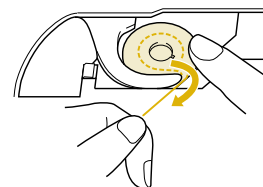

1

Getting Ready

- 6** After guiding the thread completely through the groove, pull it toward you to cut it with the cutter.

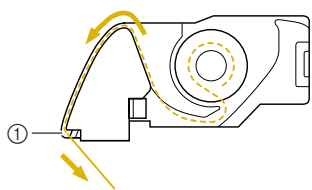

① Cutter

- 7** Attach the bobbin cover by inserting the tab in the lower-left corner of the bobbin cover, then lightly press down on the right side of the cover until it snaps into place.

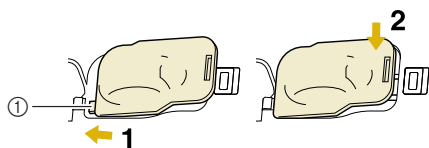

① Tab

## Pulling Up the Bobbin Thread

There may be some sewing applications where you may want to pull up the bobbin thread, for example, when making gathers or with free-motion quilting. Follow the procedure described below to pull up the bobbin thread.



### Memo

Thread the upper thread before pulling up the bobbin thread. For details, see "Upper Threading" on page 29.

- 1** Follow steps **1** through **4** from the previous section to insert the bobbin into the bobbin case.
- 2** Guide the bobbin thread through the groove, following the arrow in the illustration.



### Note

- Do not cut the thread with the cutter.
- Do not attach the bobbin cover.

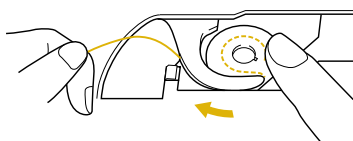

- 3** While lightly holding the upper thread, press the "Needle Position" button twice to lower, then raise the needle.

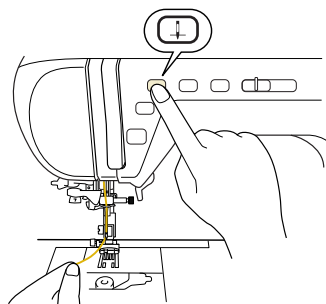

- 4** Gently pull the upper thread to pull up the bobbin thread.

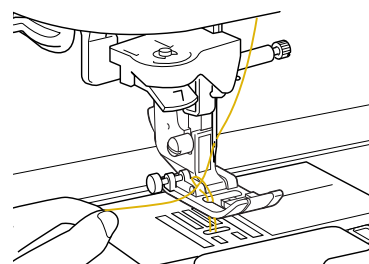

→ A loop of the bobbin thread comes out from the hole in the needle plate.

- 5** Pull out about 100 mm (approx. 3-4 inches) of the bobbin thread, and then pass it under the presser foot toward the rear of the machine, making it even with the upper thread.

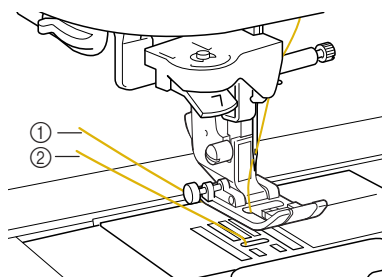

- ① Upper thread  
② Bobbin thread

- 6** Attach the bobbin cover.

## Upper Threading

This section describes how to thread the machine and the needle. The machine is marked with numbers that indicate the threading order.

### CAUTION

- Be sure to thread the machine properly. Improper threading can cause the thread to tangle and break the needle, leading to injury.
- When using accessories not included with this machine, attach the accessory to the machine after threading the machine.

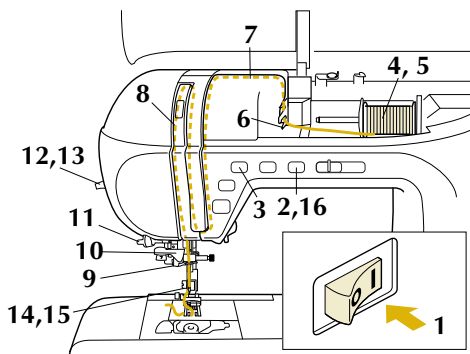

**1** Turn on the machine.

**2** Press the “Presser Foot Lifter” button to raise the presser foot.

→ The upper thread shutter opens so the machine can be threaded.

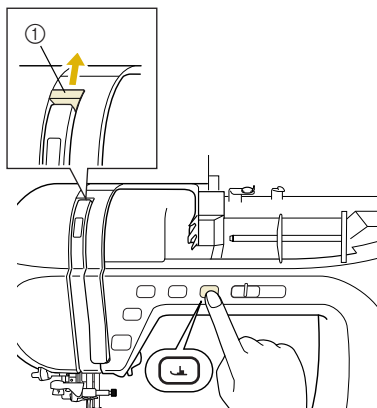

① Upper thread shutter



### Memo

This machine is equipped with an upper thread shutter, allowing you to check that the upper threading is performed correctly.

**3** Press the “Needle Position” button to raise the needle.

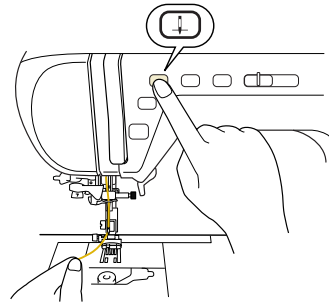

### Note

If you try to thread the needle with the needle threader lever without raising it, damage to the machine may result.

**4** Pivot the spool pin so that it angles upward, and then place the spool of thread on the spool pin.

\* Make sure that the thread unwinds from the front.

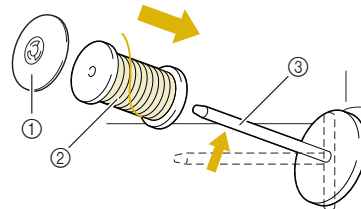

- ① Spool cap
- ② Thread spool
- ③ Spool pin

**5** Slide the spool cap as far as possible onto the spool pin, and then return the spool pin to its original position.

### CAUTION

- If the thread spool and/or spool cap are set incorrectly, the thread may tangle on the spool pin and cause the needle to break.
- Use the spool cap (large, medium, or small) that is closest in size to the thread spool. If a spool cap smaller than the thread spool is used, the thread may become caught in the slit on the end of the spool and cause the needle to break.

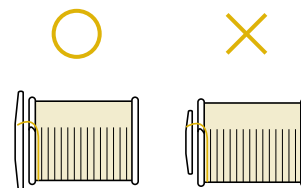

- 6** While holding the thread from the spool with both hands, pull the thread through the lower notch in the thread guide plate, then through the upper notch.

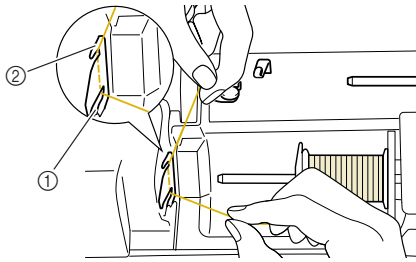

- ① Lower notch in the thread guide plate
- ② Upper notch in the thread guide plate

- 7** While holding the thread from the spool in your right hand, hold the end of the thread with your left hand, and then guide the thread through the groove, following the arrows in the illustration.

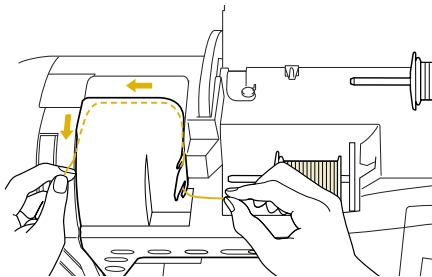

- 8** Guide the thread down, up, then down through the groove, as shown in the illustration.

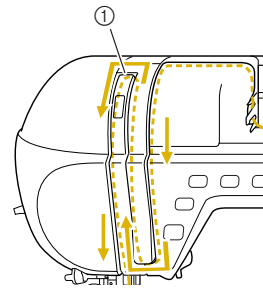

- ① Upper thread shutter



**Memo**

Look through the take-up lever check window to check the position of the take-up lever. Before threading the machine, make sure that the take-up lever is in the raised position.

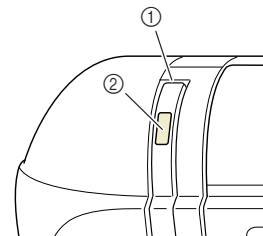

- ① Upper thread shutter
- ② Thread take-up lever check window

- 9** Pass the thread through the needle bar thread guide (marked "6").

\* Hold the thread with both hands and guide it as shown in the illustration.

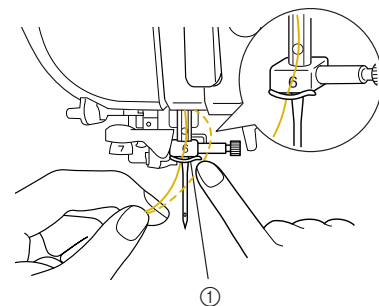

- ① Needle bar thread guide

- 10** Pass the thread through the thread guide disks (marked "7").

\* Make sure that the thread passes through the groove in the thread guide.  
 \* Make sure that the thread securely enters the thread guide disks, otherwise the needle may not be threaded.

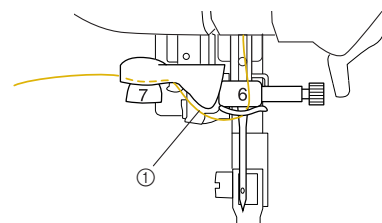

- ① Groove in thread guide



- 11** Pull the thread up through the thread cutter to cut the thread, as shown in the illustration.

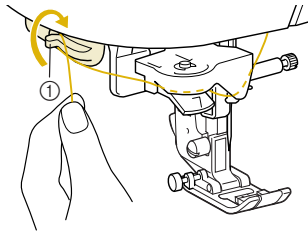

① Thread cutter



**Note**  
When using thread that quickly winds off the spool, such as metallic thread, it may be difficult to thread the needle if the thread is cut. Therefore, instead of using the thread cutter, pull out about 80 mm (approx. 3 inches) of thread after passing it through the thread guide disks (marked “7”).

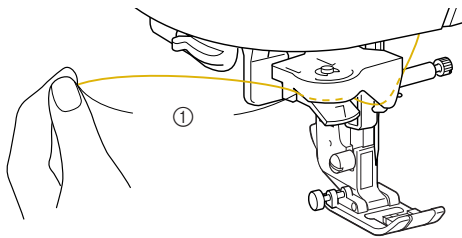

① 80 mm or more

- 12** Lower the needle threader lever slowly until it clicks.

\* The hook is rotated and passes through the eye of the needle.



- Note**
- If the needle threader lever is lowered quickly, the needle may not be threaded.
  - Make sure that no objects, such as the fabric, are touching the hook.

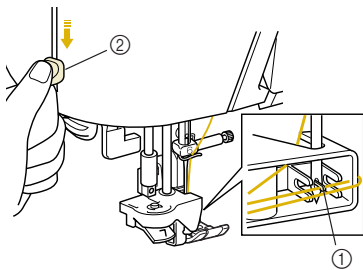

① Hook  
② Needle thread lever

- 13** Release the needle threader lever.  
→ The thread passes through the eye of the needle.

- 14** Carefully pull the end of thread that was passed through the eye of the needle.



**Note**  
Do not pull the thread strongly. Otherwise, the needle may bend or break.

\* If a loop was formed in the thread passed through the eye of the needle, carefully pull on the loop of thread through to the back of the needle.

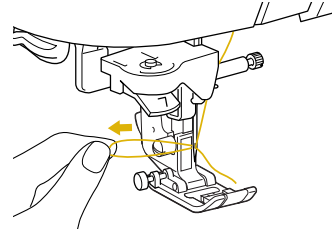

- 15** Pull out about 100 mm (approx. 3-4 inches) of the thread, and then pass it under the presser foot toward the rear of the machine.

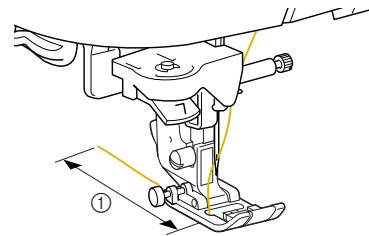

① 100 mm

- 16** Press the “Presser Foot Lifter” button to lower the presser foot before starting to sew.



**Memo**  
This completes the upper threading procedure.



- Note**
- The needle threader can be used with home sewing machine needles 75/11 through 100/16. For details on appropriate needle and thread combinations, see “Fabric/Thread/Needle Combinations” on page 37.
  - If automatic needle threading could not be completed correctly, repeat the procedure, starting with the needle bar thread guide (marked “6”).
  - Some needles cannot be threaded with the needle threader. In this case, instead of using the needle threader after passing the thread through the needle bar thread guide (marked “6”), manually pass the thread through the eye of the needle from the front.



## Using the Twin Needle

Using the twin needle, you can sew two parallel lines of the same stitch. Although the same bobbin thread is used, interesting patterns can be sewn by threading each needle with a different color of thread. Both upper threads should have the same thickness and quality. The twin needle can only be used with patterns where



appears when they are selected. Check the “STITCH SETTING CHART” at the end of this manual for patterns that can be used with the twin needle.

### CAUTION

- Use only twin needles made for this machine (part code X59296-151). Other needles could break, resulting in damage.
- Be sure to set the twin needle mode when using the twin needle. Using the twin needle while the machine is in single needle mode could cause the needle to break, resulting in damage.
- Do not sew with bent needles. The needle could break and cause injury.
- When using the twin needle, be sure to use presser foot “J”. In case bunched stitches may occur, use the presser foot “N”.

- 1 Press , and then install the twin needle (see “CHANGING THE NEEDLE” on page 35).

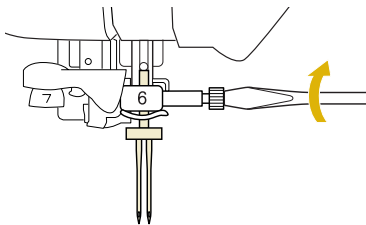

- 2 Thread the machine for the first needle according to the procedure for threading a single needle (see “Upper Threading” on page 29).

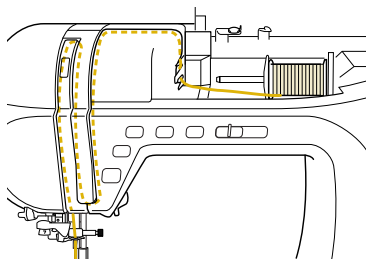

- 3 Pass the thread through the needle bar thread guide, and then thread the needle on the left side.

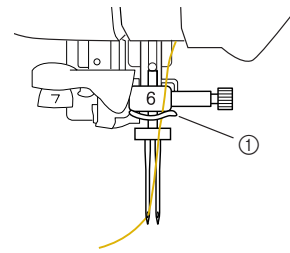

① Needle bar thread guide



### Note

The needle threader cannot be used. Manually pass the thread through the eye of the needle from the front. If the needle threader is used, damage to the machine may result.

- 4 Set the supplemental spool pin in the “up” position.

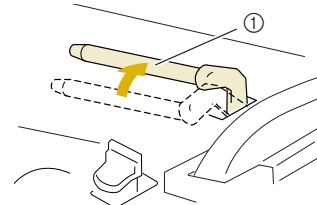

① Supplemental spool pin

- 5 Place the additional spool of thread on the supplemental spool pin so that the thread unwinds from the top. Then, slide the spool cap as far as possible onto the supplemental spool pin to secure the thread spool.

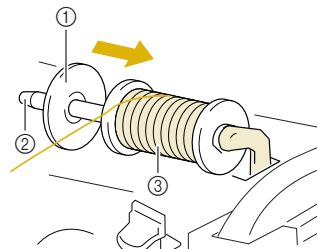

① Spool cap  
② Supplemental spool pin  
③ Thread spool

- 6 While holding the thread from the spool in your right hand, hold the end of the thread with your left hand, and then pass the thread through the thread guide.

\* Do not pass the thread through the bobbin winding pretension disk and guide.

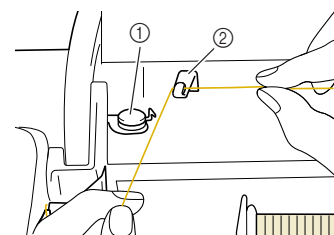

① Bobbin winding pretension disk and guide  
② Thread guide

- 7** While holding the thread from the spool with both hands, pull the thread through the lower notch in the thread guide plate, then through the upper notch. Hold the end of the thread with your left hand, and then guide the thread through the groove, following the arrows in the illustration.

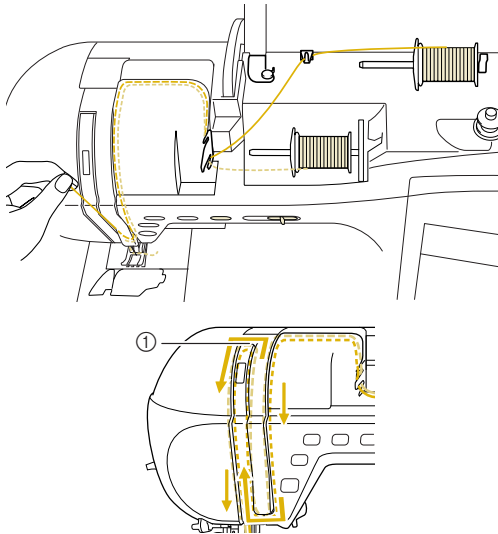

① Shutter

- 8** Without passing the thread through the needle bar thread guide, thread the needle on the right side.

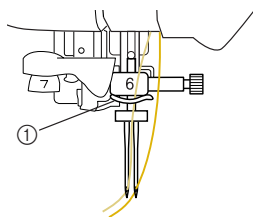

① Needle bar thread guide

**Note**  
The needle threader cannot be used. Manually pass the thread through the eye of the needle from the front. If the needle threader is used, damage to the machine may result.

- 9** Press , or press in the screen.

- 10** Select a stitch pattern.

**Note**  
If appears as after a stitch is selected, the twin needle cannot be used with the selected stitch.

- 11** Press to select the setting for twin needle sewing.

\* The stitch width becomes narrower than with single needle sewing.

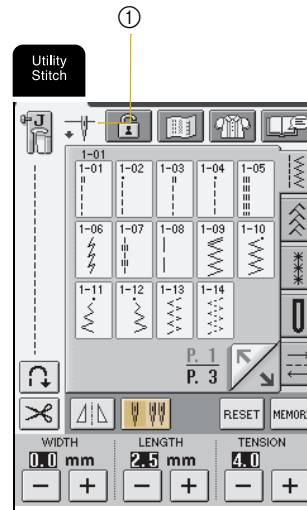

① Single needle/twin needle setting

→ appears.

**CAUTION**

- Be sure to set the twin needle mode when using the twin needle. Using the twin needle while the machine is in single needle mode could cause the needle to break, resulting in damage.

- 12** Press the “Start/Stop” button after lowering the presser foot lever.

**Memo**

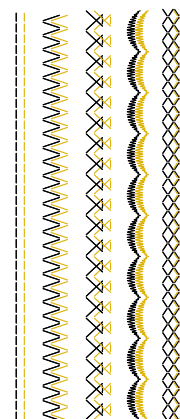

To change the sewing direction with the twin needle, raise the needle from the fabric, raise the presser foot lever, and then turn the fabric.



Getting Ready

# CHANGING THE PRESSER FOOT

## CAUTION

- Always press  in the operation panel before changing the presser foot. If  is not pressed and the “Start/Stop” button or another button is pressed, the machine will start and may cause injury.
- Always use the correct presser foot for the selected stitch pattern. If the wrong presser foot is used, the needle may strike the presser foot and bend or break, and may cause injury.
- Only use presser feet made for this machine. Using other presser feet may lead to accident or injury.

### Removing the Presser Foot

1 Press the “Needle Position” button to raise the needle.

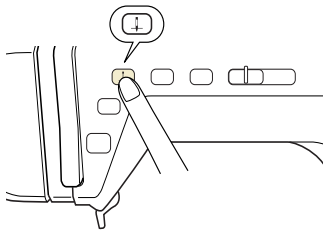

2 Press .

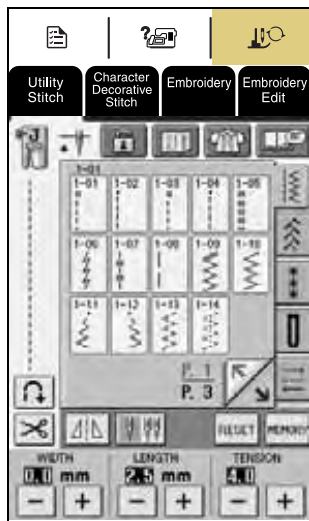

→ The screen changes, and all keys and operation buttons are locked.



3 Raise the presser foot lever.

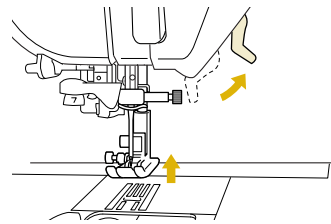

4 Press the black button on the presser foot holder to remove the presser foot.

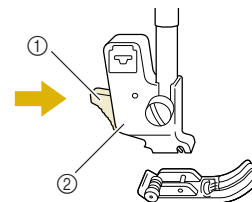



- ① Black button
- ② Presser foot holder

### Attaching the Presser Foot

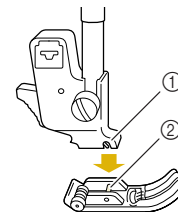
1 Place the presser foot under the holder, aligning the pin on the foot with the notch in the holder, and then lower the presser foot lever so that the presser foot pin snaps into the notch in the holder.



- ① Notch
- ② Pin



2 Press , or press  END in the screen.

→ All keys and operation buttons are unlocked, and the previous screen is displayed.

3 Raise the presser foot lever.

# CHANGING THE NEEDLE

## ⚠ CAUTION

- Always press  in the operation panel before changing the needle. If  is not pressed and the “Start/Stop” button or another operation button is pressed accidentally, the machine will start and injury may result.
- Use only sewing machine needles made for home use. Other needles may bend or break and may cause injury.
- Never sew with a bent needle. A bent needle will easily break and may cause injury.

### ■ Checking the Needle

Place the flat side of the needle on a flat surface (such as the needle plate or a piece of glass) and check that the gap between the needle and the flat surface is even.



**Note**  
Never use bent or blunt needles.

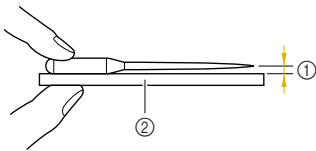

- ① Even gap
- ② Flat surface (bobbin cover, glass, etc.)

### 1 Press the “Needle Position” button to raise the needle.

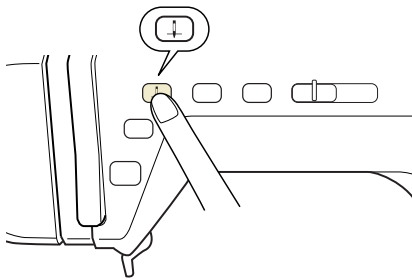

### 2 Press .



→ The screen changes, and all keys and operation buttons are locked.



### Memo

Before replacing the needle, cover the hole in the needle plate with fabric or paper to prevent the needle from falling into the machine.

- 3** Use the included screwdriver to turn the needle clamp screw toward the front of the machine to loosen it, and then remove the needle.

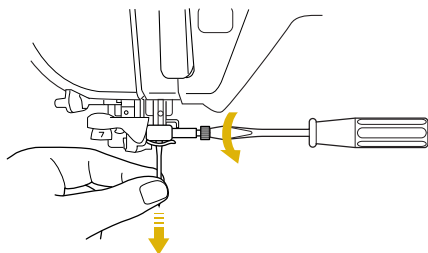

**Note**

Do not apply extreme force when loosening or tightening the needle clamp screw, otherwise damage to the machine may result.

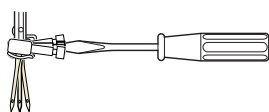

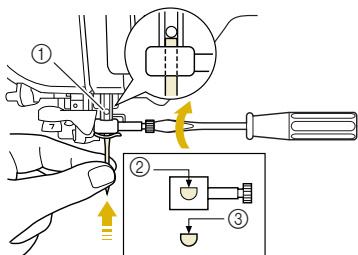

- 4** With the flat side of the needle facing the back, insert the new needle until it touches the needle stopper. Use the screwdriver to securely tighten the needle clamp screw.



- ① Needle stopper
- ② Hole for setting the needle
- ③ Flat side of needle

**! CAUTION**

- Be sure to push in the needle until it touches the stopper, and securely tighten the needle clamp screw with a screwdriver. If the needle is not completely inserted or the needle clamp screw is loose, the needle may break or the machine may be damaged.

- 5** Press , or press  END in the screen.

→ All keys and operation buttons are unlocked, and the previous screen is displayed.

## ■ About the Needle

The sewing machine needle is probably the most important part of the sewing machine. Choosing the proper needle for your sewing project will result in a beautiful finish and fewer problems. Below are some things to keep in mind about needles.

- The smaller the needle number, the finer the needle. As the numbers increase, the needles get thicker.
- Use fine needles with lightweight fabrics, and thicker needles with heavyweight fabrics.
- To avoid skipped stitches, use ball point needle (gold colored) 90/14 with stretch fabrics.
- To avoid skipped stitches, use ball point needle (gold colored) 90/14 when sewing character or decorative stitches.
- Use needle 75/11 for embroidery. Ball point needles (gold colored) 90/14 are not recommended for embroidery, as they may bend or break, causing injury.
- It is recommended that a 90/14 needle should be used when embroidering on heavyweight fabrics or stabilizing products (for example, denim, puffy foam, etc.). A 75/11 needle may bend or break, which could result in injury.
- A home sewing machine needle 75/11 is inserted in the sewing machine.

## ■ Fabric/Thread/Needle Combinations

The following table provides information concerning the appropriate thread and needle for various fabrics. Please refer to this table when selecting a thread and needle for the fabric you wish to use.

Fabric		Thread		Size of needle
		Type	Size	
Medium weight fabric	Broadcloth	Cotton	60 - 80	75/11 - 90/14
	Taffeta	Synthetic mercerized	60 - 80	
	Flannel, Gabardine	Silk or silk finished	50	
Lightweight fabric	Lawn, Batiste	Cotton	60 - 80	65/9 - 75/11
	Georgette	Synthetic mercerized	60 - 80	
	Challis, Satin	Silk	50	
Heavyweight fabric	Denim	Cotton	30 - 50	90/14 - 100/16
	Corduroy	Synthetic mercerized	50	
	Tweed	Silk	50	
Stretch fabric	Jersey	Thread for knits	50 - 60	Ball point needle (gold colored) 75/11 - 90/14
	Tricot			
For top stitching	Synthetic mercerized		30	90/14 - 100/16
	Silk		30	



### Memo

For transparent nylon thread, always use needle 90/14 - 100/16.  
The same thread is usually used for the bobbin thread and upper threading.

## ⚠ CAUTION

- Be sure to follow the needle, thread, and fabric combinations listed in the table. Using an improper combination, especially a heavyweight fabric (i.e., denim) with a small needle (i.e., 65/9 - 75/11), may cause the needle to bend or break, and lead to injury. Also, the seam may be uneven, the fabric may pucker, or the machine may skip stitches.







# Chapter 2

## Sewing Basics

<b>SEWING .....</b>	<b>40</b>
<b>Sewing a Stitch.....</b>	<b>40</b>
■ Using the Foot Controller.....	41
■ Using the Knee Lifter.....	42
<b>Sewing Reinforcement Stitches .....</b>	<b>42</b>
<b>Sewing Curves.....</b>	<b>42</b>
<b>Changing Sewing Direction.....</b>	<b>42</b>
■ Sewing a Seam Allowance of 0.5 cm or Less .....	42
<b>Sewing Heavyweight Fabric .....</b>	<b>43</b>
■ If the Fabric Does Not Fit Under the Presser Foot.....	43
■ If the Fabric Does Not Feed .....	43
<b>Sewing Lightweight Fabric .....</b>	<b>43</b>
<b>ADJUSTING STITCH SETTINGS .....</b>	<b>44</b>
<b>Adjusting the Stitch Width .....</b>	<b>44</b>
<b>Adjusting the Stitch Length .....</b>	<b>44</b>
<b>Adjusting the Thread Tension.....</b>	<b>45</b>
■ Correct Thread Tension.....	45
■ Upper Thread Is Too Tight .....	45
■ Upper Thread Is Too Loose .....	45
<b>USEFUL FUNCTIONS .....</b>	<b>46</b>
<b>Automatic Reinforcement Stitching .....</b>	<b>46</b>
<b>Automatic Thread Cutting.....</b>	<b>46</b>
<b>Locking the Screen .....</b>	<b>47</b>

# SEWING

## ⚠ CAUTION

- To avoid injury, pay special attention to the needle while the machine is in operation. Keep your hands away from moving parts while the machine is in operation.
- Do not stretch or pull the fabric during sewing. Doing so may lead to injury.
- Do not use bent or broken needles. Doing so may lead to injury.
- Take care that the needle does not strike basting pins or other objects during sewing. Otherwise, the needle may break and cause injury.
- If stitches become bunched, lengthen the stitch length setting before continuing sewing. Otherwise, the needle may break and cause injury.

## Sewing a Stitch

- 1 Turn on the machine, and then press the “Needle Position” button to raise the needle.
- 2 Select a stitch pattern.



→ The symbol for the correct presser foot appears in the upper-left corner of the LCD.

- 3 Install the presser foot (see “CHANGING THE PRESSER FOOT” on page 34).

## ⚠ CAUTION

- Always use the correct presser foot. If the wrong presser foot is used, the needle may strike the presser foot and bend or break, possibly resulting in injury.

- 4 Place the fabric under the presser foot, hold the fabric and thread ends with your left hand, and then turn the handwheel to lower the needle into the fabric at the starting point of the stitching.

\* The black button on the left side of presser foot “J” should be pressed only if the fabric does not feed or when sewing thick seams. Normally, you can sew without pressing the black button.

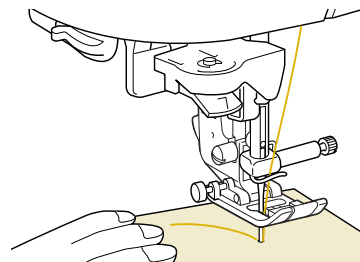

- 5 Lower the presser foot lever.



### Memo

You can start sewing without pulling up the bobbin thread.

- 6 Slide the sewing speed controller to adjust the sewing speed.



### Memo

The sewing speed can also be adjusted during sewing.

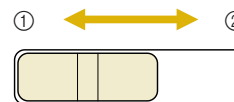

- ① Slow
- ② Fast

- 7 Lightly place your hands on the fabric to guide it, and then press the “Start/Stop” button to start sewing.

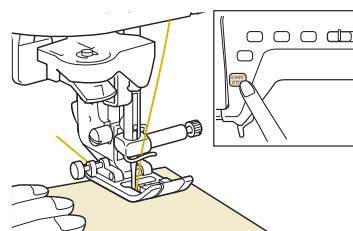

- 8** To stop sewing, press the “Start/Stop” button again.

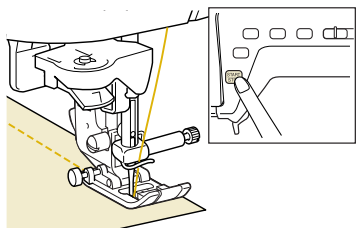

- 9** Press the “Thread Cutter” button to trim the threads.

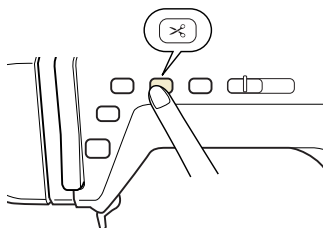

→ The needle automatically stops in the raised position.

### CAUTION

- Do not press the “Thread Cutter” button after the threads have been cut. Doing so could tangle the thread or break the needle and damage the machine.
- Do not press the “Thread Cutter” button when there is no fabric set in the machine or during machine operation. The thread may tangle, possibly resulting in damage.

### Note

When cutting thread thicker than #30, nylon thread or other decorative threads, use the thread cutter on the side of the machine.

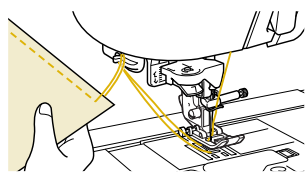

- 10** When the needle has stopped moving, raise the presser foot and remove the fabric.

### Note

This machine is equipped with a bobbin thread sensor that warns you when the bobbin thread is almost empty. When the bobbin thread is nearly empty, the machine stops automatically and a message appears in the screen. When this message appears, change the bobbin with one full of thread. However, if the “Start/Stop” button is pressed, a few stitches can be sewn.

## Using the Foot Controller

You can also use the foot controller to start and stop sewing.

### CAUTION

- Do not allow fabric pieces and dust to collect in the foot controller. Doing so could cause a fire or an electric shock.

### Memo

- When the foot controller is being used, the “Start/Stop” button has no effect on sewing.
- The foot controller cannot be used when embroidering.

- 1** Pull the retractable cord out from the foot controller to the desired length, and then insert the foot controller plug into its jack on the machine.

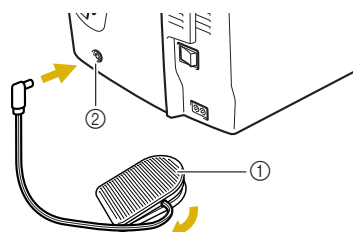

- ① Foot controller  
② Foot controller jack

### Note

Do not pull retractable cord out beyond the red mark.

- 2** Slowly press the foot controller to start sewing.

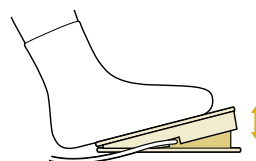

### Memo

The speed set using the sewing speed controller is the foot controller's maximum sewing speed.

- 3** Release the foot controller to stop the machine.



2

Sewing Basics

### ■ Using the Knee Lifter

Using the knee lifter, you can raise and lower the presser foot with your knee, leaving both hands free to handle the fabric.

- 1 **Align the tabs on the knee lifter with the notches in the jack, and then insert the knee lifter as far as possible.**

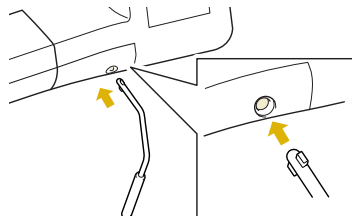

**Note**  
If the knee lifter is not pushed into the mounting slot as far as possible, it may come out during use.

- 2 **Use your knee to move the knee lifter to the right in order to raise the presser foot. Release the knee lifter to lower the presser foot.**

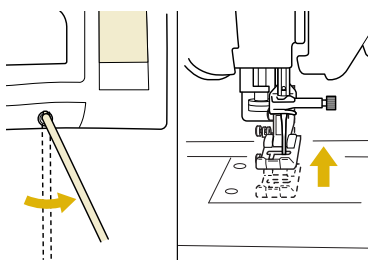

**Note**  
When the presser foot is in raised position, move the knee lifter further to the right for the presser foot to lower.

### ⚠ CAUTION

- Be sure to keep your knee away from the knee lifter during sewing. If the knee lifter is pushed during machine operation, the needle may break or the thread tension may loosen.

## Sewing Reinforcement Stitches

Generally stitching must be secured at the beginning and end with reverse/reinforcement stitches. Press the "Reverse/Reinforcement Stitch" button to sew reverse/reinforcement stitches.

Depending on the selected stitch pattern, reverse or reinforcement stitches are sewn while the "Reverse/Reinforcement Stitch" button is kept pressed. With reinforcement stitches, 3 to 5 stitches are sewn at the same place. With reverse stitches, the stitching is sewn at a low speed in the opposite direction. In addition, this machine can be set to sew reinforcement stitches (or reverse stitches) automatically. For details, see "Automatic Reinforcement Stitching" on page 46.

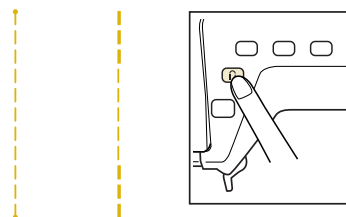

## Sewing Curves

Sew slowly while keeping the seam parallel with the fabric edge as you guide the fabric around the curve.

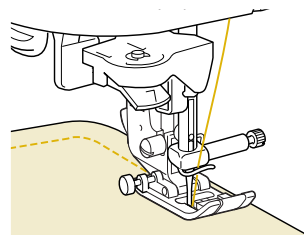

## Changing Sewing Direction

Stop the machine with the needle in the fabric at the point where you want to change the sewing direction, and then raise the presser foot lever. Using the needle as a pivot, turn the fabric, lower the presser foot lever, and then continue sewing.

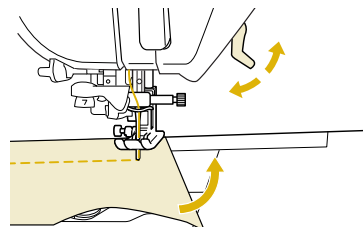

### ■ Sewing a Seam Allowance of 0.5 cm or Less

Baste the corner before sewing, and then, after changing the sewing direction at the corner, pull the basting thread toward the back while sewing.

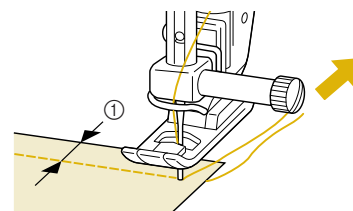

① 0.5 cm (approx. 3/16 inch)

## Sewing Heavyweight Fabric

### ■ If the Fabric Does Not Fit Under the Presser Foot

The presser foot lever can be raised to two different positions. If the fabric is too thick to fit under the presser foot, raise the presser foot lever to its highest position so that the fabric can be placed under the presser foot.

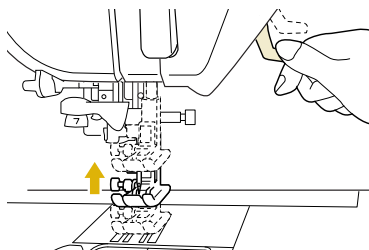

#### Memo

If the fabric cannot be smoothly placed under the presser foot, select the presser foot height higher on the setting screen (see page 20).

The default is 7.5 mm from the needle plate when the presser foot is raised.

### ■ If the Fabric Does Not Feed

If the fabric does not feed when starting to sew or when sewing thick seams, press the black button on the left side of presser foot "J".

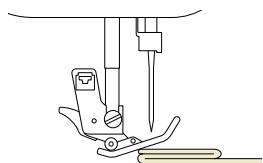

1

#### Raise the presser foot lever.

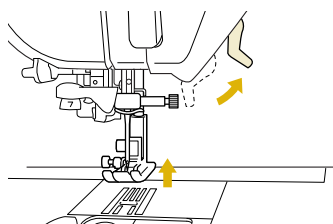

2

While keeping the black button on the left side of presser foot "J" pressed in, lower the presser foot lever.

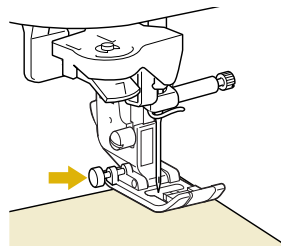

\* The presser foot remains level, enabling the fabric to be fed. Once the trouble spot has been sewn, the presser foot will return to its normal operation.

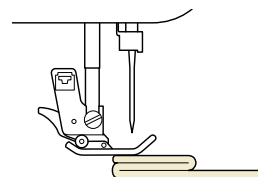

### ! CAUTION

- Do not forcefully push fabrics more than 6 mm (approx. 1/4 inch) thick through the sewing machine. This may cause the needle to break and cause injury.

## Sewing Lightweight Fabric

Iron the fabric with starch or place thin paper or tear away embroidery stabilizer under thin fabrics to make sewing easier. Gently tear off the paper or the stabilizer after sewing.

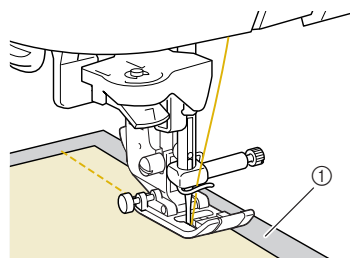

① Thin paper



2

Sewing Basics

# ADJUSTING STITCH SETTINGS

When a stitch is selected, the most appropriate stitch width, stitch length, and upper thread tension are automatically set. However, if needed, you can change any of the settings as described in this section.

**Note**

- Settings for some stitches cannot be changed.  indicates no change is possible (see the “STITCH SETTING CHART” at the end of this manual).
- If a stitch setting is changed, but not saved, the stitch setting returns to its default when the machine is turned off or a different stitch is selected.

## Adjusting the Stitch Width

The stitch width (zigzag width) can be adjusted to make the stitch wider or narrower.

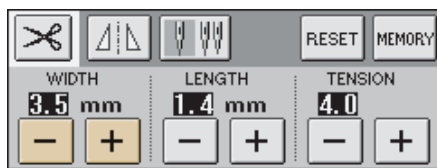

**Memo**

If the foot controller is connected, the sewing speed controller can be used to adjust the zigzag width (see page 69).

Each press of  makes the zigzag stitch narrower.

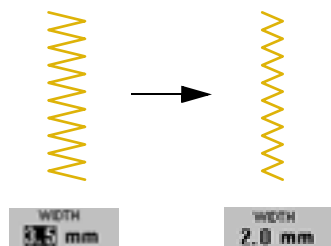

Each press of  makes the zigzag stitch wider.

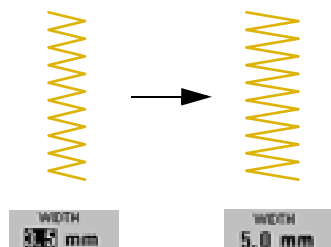

Press  to return the setting to its default.

## Adjusting the Stitch Length

The stitch length can be adjusted to make the stitch coarser or finer.

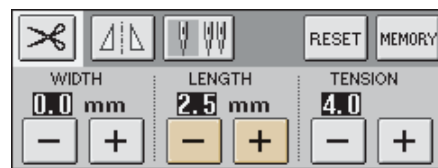

Each press of  makes the stitch finer (shorter).

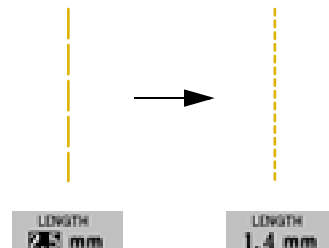

Each press of  makes the stitch coarser (longer).

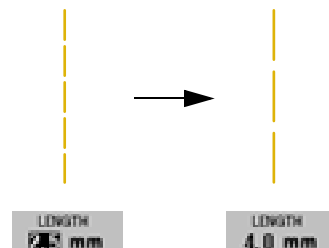

Press  to return the setting to its default.

**CAUTION**

- If the stitches get bunched together, lengthen the stitch length and continue sewing. Do not continue sewing without lengthening the stitch length. Otherwise, the needle may break and cause injury.

## Adjusting the Thread Tension

The default thread tension, which is automatically set, can normally be used regardless of the type of thread or fabric being sewn. However, with some fabric and thread combinations, the thread tension may need to be adjusted.

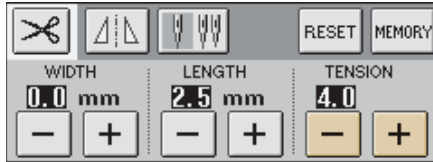

### Memo

If the upper thread is not threaded correctly or the bobbin is not set correctly, the correct thread tension cannot be set. If the correct thread tension cannot be achieved, rethread the upper thread and reset the bobbin correctly.

### Correct Thread Tension

The upper thread and the bobbin thread should cross near the center of the fabric. If the thread tension is incorrectly set, the seam may have a poor finish or the fabric may pucker.

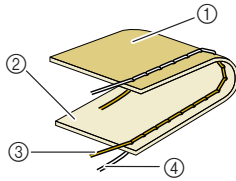

- ① Wrong side of fabric
- ② Surface of fabric
- ③ Upper thread
- ④ Bobbin thread

### Upper Thread Is Too Tight

If the bobbin thread can be seen on the surface of the fabric, press **-**. Each press of the key reduces the setting and makes the thread tension looser.

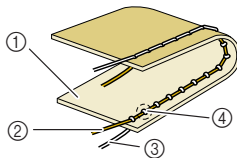

- ① Surface of fabric
- ② Upper thread
- ③ Bobbin thread
- ④ Locks appear on the surface of the fabric.

### Upper Thread Is Too Loose

If the upper thread can be seen on the wrong side of the fabric, press **+**. Each press of the key increases the setting and makes the thread tension tighter.

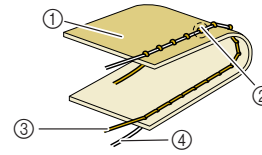

- ① Wrong side of fabric
- ② Locks appear on the wrong side of the fabric.
- ③ Upper thread
- ④ Bobbin thread

Press **RESET** to return the setting to its default.



2

Sewing Basics

# USEFUL FUNCTIONS

## Automatic Reinforcement Stitching

After selecting a stitch pattern, turn on the automatic reinforcement stitching setting before sewing, and the machine will automatically sew reinforcement stitches (or reverse stitches, depending on the stitch pattern) at the beginning and end of sewing.

- 1 Select a stitch pattern.
- 2 Press  to select the automatic reinforcement/reverse stitching setting.



### Memo

The automatic reinforcement/reverse stitching setting is already selected with some stitches, such as buttonholes and bar tacks.

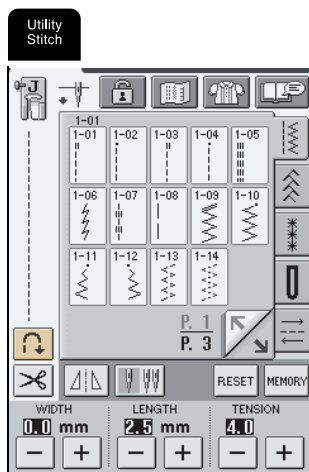

→ The key appears as .

- 3 Place the fabric under the presser foot with the needle at the starting point of the stitching, and then press the “Start/Stop” button. The machine will automatically sew reverse stitches (or reinforcement stitches), and then begin sewing.

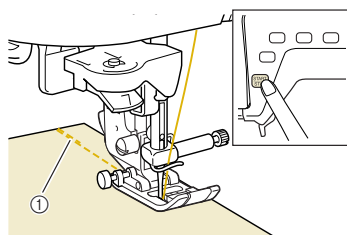

① Reverse stitches (or reinforcement stitches)



### Memo

If you press the “Start/Stop” button to pause sewing, then press it again to continue, reverse stitches (or reinforcement stitches) will not be sewn.

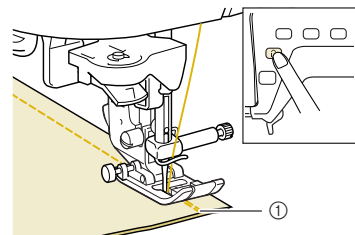

- 4 If the “Reverse/Reinforcement Stitch” button is pressed, the machine automatically sews reverse stitches (or reinforcement stitches), then stops.



① Reverse stitches (or reinforcement stitches)



### Memo

To cancel the automatic reverse/reinforcement stitching setting, press  again so that it appears as .

## Automatic Thread Cutting

If the automatic thread cutting setting is selected before sewing, the machine will automatically sew reinforcement stitches (or reverse stitches, depending on the selected stitch pattern) and cut the thread when the “Reverse/Reinforcement Stitch” button is pressed at the end of stitching. This is useful when sewing buttonholes and bar tacks.



### Memo

- The automatic thread cutting setting can be selected when the automatic reinforcement/reverse stitching setting is selected.
- The automatic thread cutting setting is already selected with embroidery patterns.

- 1 Select a stitch pattern.



- 2 Press  to select the automatic thread cutting setting.

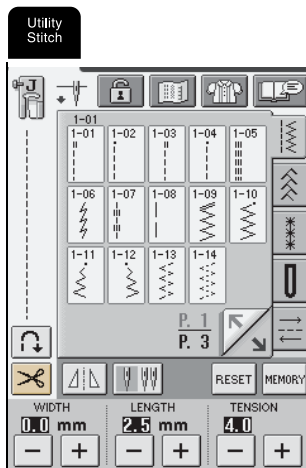

→ The key appears as .

- 3 Place the fabric under the presser foot with the needle at the starting point of the stitching, and then press the “Start/Stop” button. The machine will automatically sew reverse stitches (or reinforcement stitches), and then begin sewing.

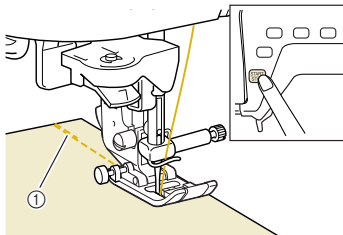

① Reverse stitches (or reinforcement stitches)

 **Memo**

If you press the “Start/Stop” button to pause sewing, then press it again to continue, reverse stitches (or reinforcement stitches) will not be sewn.

- 4 If the “Reverse/Reinforcement Stitch” button is pressed, the machine automatically sews reverse stitches (or reinforcement stitches), then cuts the thread.

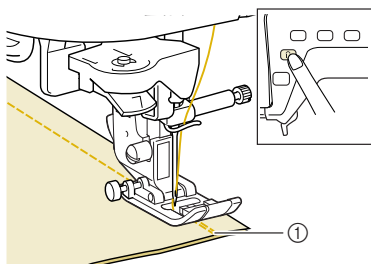

① Reverse stitches (or reinforcement stitches)

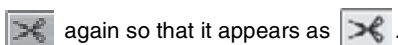

 **Memo**

To cancel the automatic thread cutting setting, press















## Locking the Screen

If the screen is locked before starting to sew, the various settings, such as the stitch width and stitch length, are locked and cannot be changed. This prevents screen settings from accidentally being changed or the machine from being stopped while large pieces of fabric or other projects are being sewn. The screen can be locked while sewing utility stitches and character/ decorative stitches.

- 1 Select a stitch pattern.
- 2 If necessary, adjust any settings, such as the stitch width and stitch length.
- 3 Press  .  
→ The key appears as .
- 4 Sewing begins.
- 5 When you are finished sewing, press  to unlock the screen.

 **Note**

- When the screen is locked (  ), no key other than  and the     keys can be operated. To select a different stitch pattern or change the settings, press  so that it appears as  to unlock the screen.
- When the screen is locked, pressing any of the     keys unlocks the screen.
- The screen is unlocked when the machine is turned off.



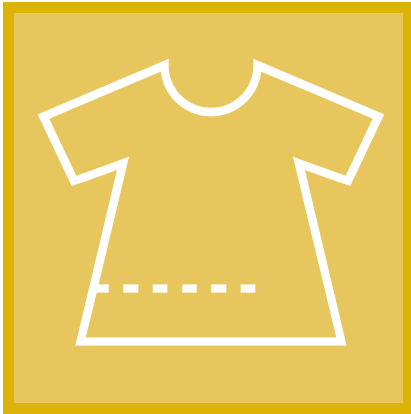

# Chapter 3

## Utility Stitches

### SELECTING A UTILITY STITCH .....50

- Stitch Selection Screens .....50
- Selecting a Stitch Pattern..... 51
  - Using the Mirror Image Key .....51
  - Using the Image Key .....51
- Saving Stitch Settings..... 52
- Using the Sewing Type Selection Key ..... 53

### SEWING THE STITCHES .....54

- Straight Stitches..... 54
  - Changing the Needle Position (Left or Middle Needle Position Stitches Only) ....55
  - Using the Straight Stitch Needle Plate and the Straight Stitch Foot.....56
  - Basting .....57
- Darts Seams..... 58
- Gathering ..... 58
- Flat Fell Seams..... 59
- Pintucks..... 60
- Zigzag Stitches ..... 61
  - Overcasting.....61
  - Appliqués .....61
  - Patchwork (Crazy Quilts).....62
  - Sewing Curves.....62
- Elastic Zigzag Stitches ..... 62
  - Tape attaching.....62
  - Overcasting.....62
- Overcasting..... 63
  - Overcasting Using Presser Foot “G” .....63
  - Overcasting Using Presser Foot “J” .....64
  - Overcasting Using the Optional Side Cutter .....65
  - When Sewing Straight Stitches While Using the Side Cutter .....66
- Quilting..... 67
  - Piecing .....67
  - Quilting.....68
  - Appliqués .....68
  - Satin Stitching .....69
  - Free-motion Quilting.....70
- Blind Hem Stitches..... 71
  - If the Needle Does Not Catch the Fold .....72
  - If the Needle Catches Too Much of the Fold .....72
- Appliqués ..... 72
  - Sewing Sharp Curves.....73
- Shell Tuck Stitching..... 73
- Scalloping..... 73
- Top Stitching ..... 74
- Smocking..... 74
- Fagoting..... 75

### Tape or Elastic Attaching .....76

### Heirloom Stitching.....77

- Heirloom stitching/Hemstitching (1) (Daisy Stitch).....77
- Heirloom stitching/Hemstitching (2) (Drawn Work (1)).....77
- Heirloom stitching/Hemstitching (3) (Drawn Work (2)).....78

### Buttonhole Stitches.....79

- Sewing Stretch Fabrics .....82
- Buttons That Do Not Fit into the Button Holder Plate .....82
- Darning .....83

### Bar Tacks .....84

- Bar Tacks on Thick Fabrics .....85

### Button Sewing.....86

- Attaching a 4-Hole Button.....87
- Attaching a Button with a Shank .....87

### Eyelets.....87

### Multi-Directional Sewing

### (Straight Stitch and Zigzag Stitch) ..... 88

### Zipper Insertion .....89

- Centered Zipper .....89
- Side Zipper .....90

# SELECTING A UTILITY STITCH

## ■ Stitch Selection Screens

Press  to display the previous or next page.

### Straight/Overcasting/Quilting Stitches

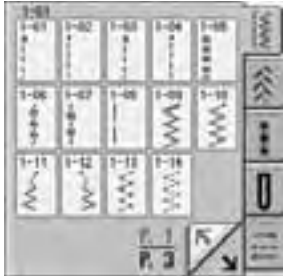

### Decorative Stitches



### Heirloom Stitches

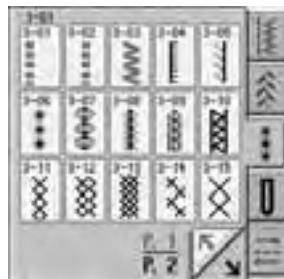

### Buttonholes/Bar tacks



### Multi-Directional Sewing



## Selecting a Stitch Pattern

- 1 Turn on the machine, and then lightly press the display.

→ Depending on the setting, either "1-01 Straight stitch (Left)" or "1-03 Straight stitch (Middle)" is automatically selected.

- 2 Press  to display a screen of the stitches in the selected category, and then select a stitch pattern.

\* If a different screen is displayed, press .

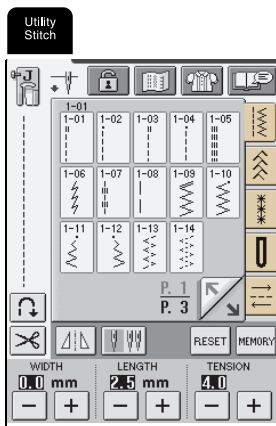



→ An image of the selected stitch pattern is displayed below the symbol of the appropriate presser foot.

### Memo

For details on the stitch patterns, refer to the "STITCH SETTING CHART" at the end of this manual.

## Using the Mirror Image Key

Press  so that it appears as . A mirror image of the selected stitch pattern is created.

### Note

If  appears as  after a stitch (buttonholes, multi-directional sewing patterns, etc.) is selected, a mirror image of the selected stitch cannot be created.

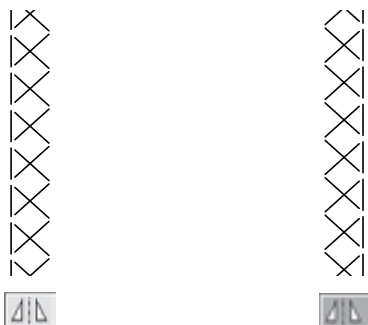

## Using the Image Key

You can display an image that is an approximate size of the selected stitch. You can also check and change the colors of the image on the screen.

- 1 Press .

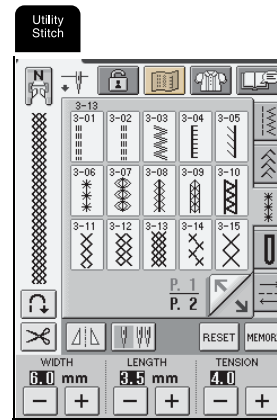

→ An image of the selected stitch is displayed.

- 2 Press  to change the thread color of the stitch on the screen.

### Memo

- The color changes every time you press .
- The units of the stitch display area are in mm.

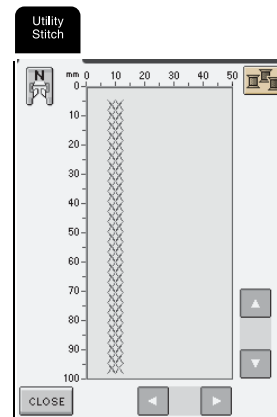

① Stitch screen



Utility Stitches

3 Press **CLOSE** to go back to the original screen.

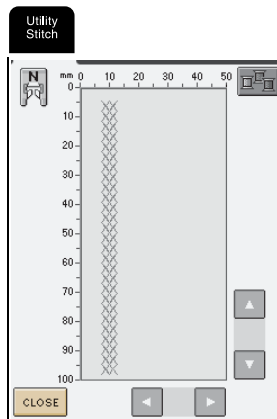

## Saving Stitch Settings

This machine is preset with the default settings for the stitch width (zigzag width), stitch length, thread tension, automatic thread cutting, automatic reverse/reinforcement stitching, etc. However, if you wish to save specific settings for a stitch so that they can be used later, press **MEMORY** after changing the settings to save the new settings with the selected stitch.

**Example:** Using a stitch length of 2.0 mm for the straight stitch

1 Select a straight stitch.



### Memo

The default stitch length is 2.5 mm.

2 Set the stitch length to 2.0 mm.

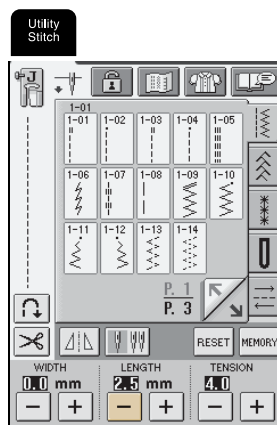

3 Press **MEMORY**.

\* To reset the selected stitch pattern to its default settings, press **RESET**, and then press **MEMORY**.

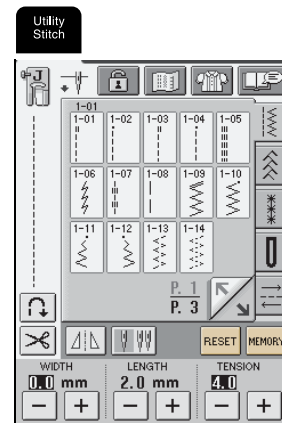

→ The confirmation message appears.

4 Press **OK**.

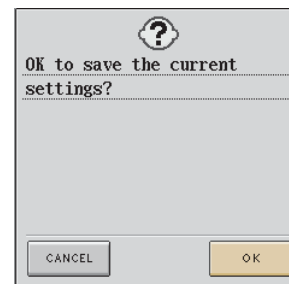



### Memo

- The next time that the same straight stitch is selected, the stitch length is set to 2.0 mm.
- All stitch settings (stitch width (zigzag width), stitch length, thread tension, automatic thread cutting, and automatic reverse/reinforcement stitching) are saved, not just the setting that was changed. When the same stitch pattern is selected, the last settings saved are displayed even if the machine was turned off. If the settings are changed again and **MEMORY** is pressed, or if **RESET** is pressed to reset the setting to its default, the new settings are not saved unless **MEMORY** is pressed another time.
- Even if **RESET** is pressed, the settings for automatic thread cutting and automatic reverse/reinforcement stitch cannot be reset.

## Using the Sewing Type Selection Key



By pressing , a utility stitch can also be selected according to its desired use. When you are not sure which stitch to select for your application or when you need information on how certain stitches are used, press , select the appropriate stitch for your project, and then follow the instructions to sew the selected stitch.

We recommend that beginners use this method to select stitches.

**Example:** Displaying information about overcasting

**1** Press  .

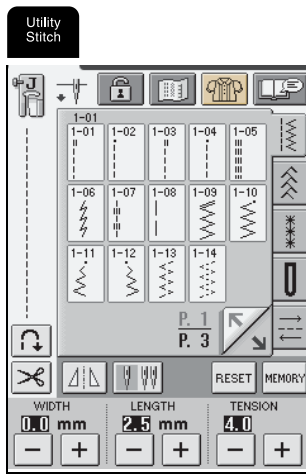

→ The advice screen is displayed.

**2** Press  .

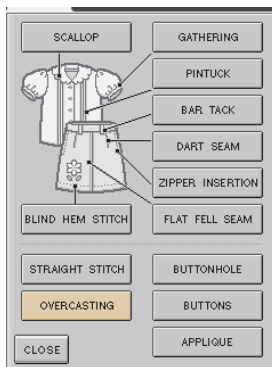

→ The upper part of the screen displays a selection of overcasting stitches with explanations.

**3** Read the descriptions, and then select the appropriate stitch.

\* Press  or  to scroll the page.

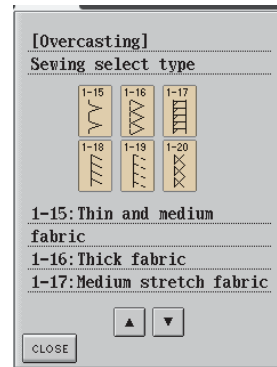



→ The screen displays directions for sewing the selected stitch.

**4** Follow the directions to sew the stitch.

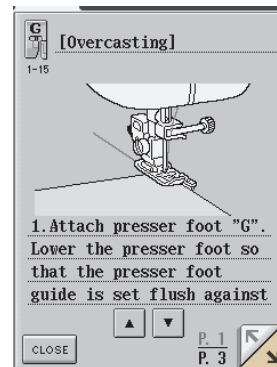
\* Press  to display the next page.



\* Press  or  to view additional instructions for that page.

**5** When you have finished sewing, press  .



















3

Utility Stitches

# SEWING THE STITCHES

## Straight Stitches

 **Note** When using the twin needle (see page 32), be sure to attach presser foot “J”.

Stitch Key	Stitch Name	Presser Foot	Applications	Stitch width [mm (inch.)]		Stitch length [mm (inch.)]		Twin needle
				Auto.	Manual	Auto.	Manual	
	<b>Straight stitch (Left)</b>		General sewing, gather, pintuck, etc. Reverse stitch is sewn while pressing “Reverse/Reinforcement Stitch” button.	<b>0.0 (0)</b>	0.0 - 7.0 (0 - 1/4)	<b>2.5 (3/32)</b>	0.2 - 5.0 (1/64 - 3/16)	OK (J)
	<b>Straight stitch (Left)</b>		General sewing, gather, pintuck, etc. Reinforcement stitch is sewn while pressing “Reverse/Reinforcement Stitch” button.	<b>0.0 (0)</b>	0.0 - 7.0 (0 - 1/4)	<b>2.5 (3/32)</b>	0.2 - 5.0 (1/64 - 3/16)	OK (J)
	<b>Straight stitch (Middle)</b>		General sewing, gather, pintuck, etc. Reverse stitch is sewn while pressing “Reverse/Reinforcement Stitch” button.	<b>3.5 (1/8)</b>	0.0 - 7.0 (0 - 1/4)	<b>2.5 (3/32)</b>	0.2 - 5.0 (1/64 - 3/16)	OK (J)
	<b>Straight stitch (Middle)</b>		General sewing, gather, pintuck, etc. Reinforcement stitch is sewn while pressing “Reverse/Reinforcement Stitch” button.	<b>3.5 (1/8)</b>	0.0 - 7.0 (0 - 1/4)	<b>2.5 (3/32)</b>	0.2 - 5.0 (1/64 - 3/16)	OK (J)
	<b>Triple stretch stitch</b>		General sewing for reinforcement and decorative top stitching	<b>0.0 (0)</b>	0.0 - 7.0 (0 - 1/4)	<b>2.5 (3/32)</b>	1.5 - 4.0 (1/16 - 3/16)	OK (J)
	<b>Stem stitch</b>		Reinforced stitching, sewing and decorative applications	<b>1.0 (1/16)</b>	1.0 - 3.0 (1/16 - 1/8)	<b>2.5 (3/32)</b>	1.0 - 4.0 (1/16 - 3/16)	OK (J)
	<b>Decorative stitch</b>		Decorative stitching, top stitching	<b>0.0 (0)</b>	0.0 - 7.0 (0 - 1/4)	<b>2.5 (3/32)</b>	1.0 - 4.0 (1/16 - 3/16)	OK (J)
	<b>Basting stitch</b>		Basting	<b>0.0 (0)</b>	0.0 - 7.0 (0 - 1/4)	<b>20.0 (3/4)</b>	5.0 - 30.0 (3/16 - 1-3/16)	NO

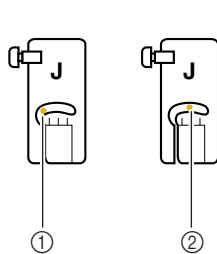

- ① Left needle position
- ② Middle needle position

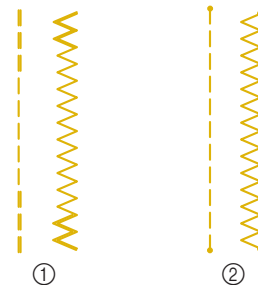

- ① Reverse stitch
- ② Reinforcement stitch

 **Memo**

“■” at the beginning of the stitch shown on the key indicates that reverse stitches are sewn when the “Reverse/Reinforcement Stitch” button is pressed. “-” at the beginning of the stitch shown on the key indicates that reinforcement stitches are sewn when the “Reverse/Reinforcement Stitch” button is pressed.



**1** Select a stitch pattern.

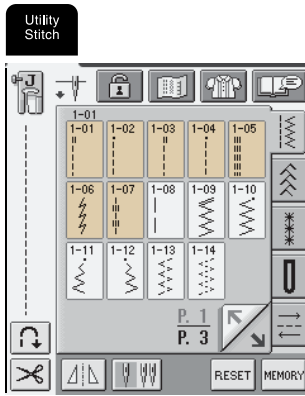

**2** Attach presser foot "J".

**3** Hold the thread ends and the fabric with your left hand, and turn the handwheel toward you with your right hand to insert the needle into the fabric at the starting point of the stitching.

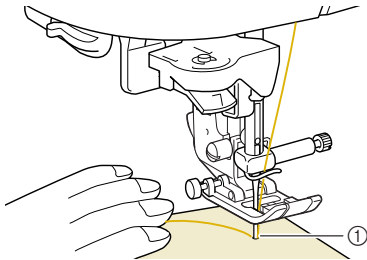

① Starting point of stitching

**4** Lower the presser foot lever.

**5** Hold the "Reverse/Reinforcement Stitch" button pressed to sew reverse stitches (or reinforcement stitches), and then press the "Start/Stop" button to start sewing slowly.

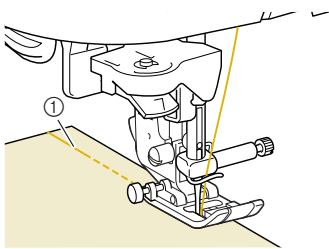

① Reverse stitches

**CAUTION**

- Be sure the needle does not strike a basting pin, or any other objects, during sewing. The thread could tangle or the needle could break, causing injury.

**6** At the end of the stitching, hold the "Reverse/Reinforcement Stitch" button pressed to sew reverse stitches (or reinforcement stitches).

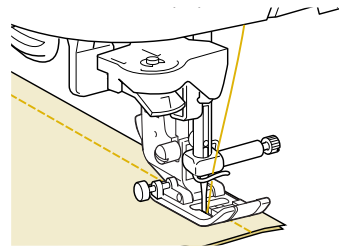

**7** Press the "Thread Cutter" button to trim the threads.

- \* If the automatic thread cutting setting is selected before sewing, the machine will automatically sew reverse stitches (or reinforcement stitches) at the beginning of stitching. When the "Reverse/Reinforcement Stitch" button is pressed at the end of stitching, the machine will automatically sew reverse stitches (or reinforcement stitches) and cut the thread.

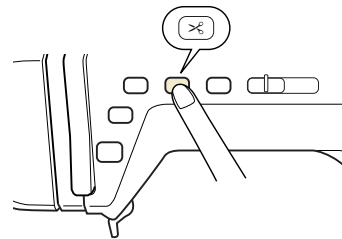

**Changing the Needle Position (Left or Middle Needle Position Stitches Only)**

When you select left or middle needle position stitches, you can use **-** and **+** in the stitch width display to change the position of the needle. Match the distance from the right edge of the presser foot to the needle with the stitch width, then align the edge of the presser foot with the edge of the fabric during sewing for an attractive finish.

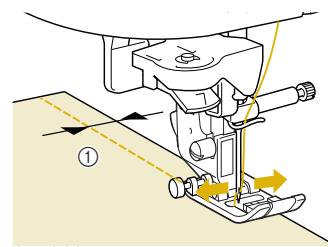

① Stitch width

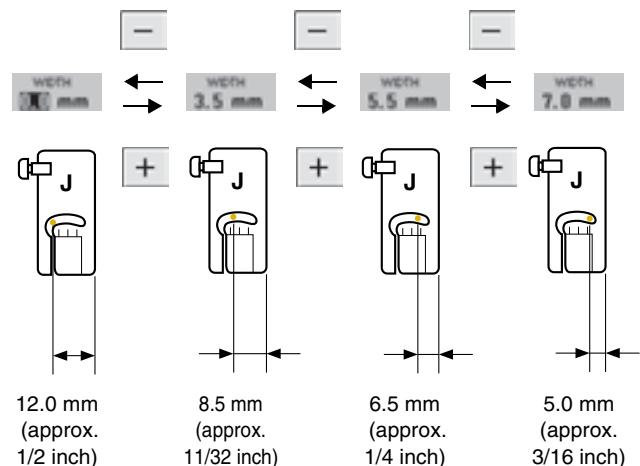

3

Utility Stitches



**Memo**

For a standard 16 mm (approx. 5/8 inch) seam allowance, set the width to 0 mm on the screen. While sewing, align the edge of the fabric with the 16mm (approx. 5/8 inch) mark on the needle plate.

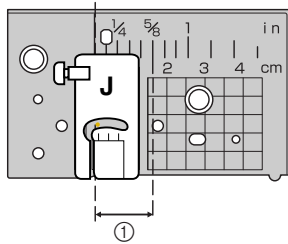

① 16 mm (approx. 5/8 inch)

**Using the Straight Stitch Needle Plate and the Straight Stitch Foot**

The straight stitch needle plate and the straight stitch foot can only be used for straight stitches (middle needle position stitches). Use the straight stitch needle plate and the straight stitch foot when sewing thin fabrics or when sewing small pieces which tend to sink into the hole of the regular needle plate during sewing. The straight stitch foot is perfect to reduce puckering on lightweight fabrics. The small opening on the foot provides support for the fabric as the needle goes through the fabric.

**CAUTION**

- Always use the straight stitch foot in combination with the straight stitch needle plate.

- 1 Press the “Presser Foot Lifter” button to raise the presser foot and turn the main power to OFF.
- 2 Remove the flat bed attachment or the embroidery unit if either are attached.
- 3 Grasp both sides of the needle plate cover, and then slide it toward you.

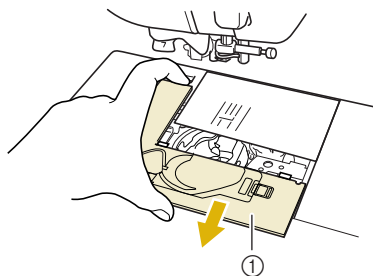

① Needle plate cover

- 4 Grasp the bobbin case, and then pull it out.

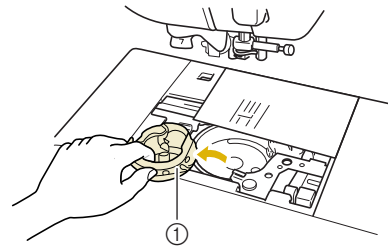

① Bobbin case

- 5 Use the screwdriver included with the machine to unscrew and remove the regular needle plate.

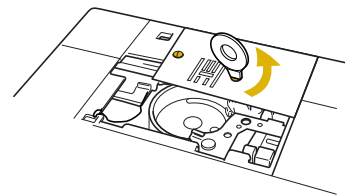

- 6 Set the straight stitch needle plate in place and use the screwdriver to tighten the plate.

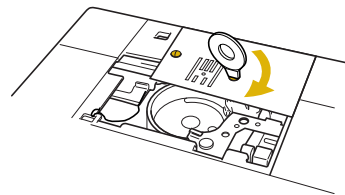

**Note**

Align the two screw holes on the needle plate with the two holes on the machine and screws in the needle plate.

- 7 Insert the bobbin case in its original position (see page 185), and then attach the needle plate cover.
- 8 After reinstalling the needle plate cover, select any of the straight stitches.



**Memo**

- When using the straight stitch needle plate, all straight stitches become middle needle position stitches. You cannot change the needle position using the width display.
- Selecting other stitches will cause an error message to be displayed.

- 9 Attach the straight stitch foot and align the edge of the fabric with a specific marking on the straight stitch foot.

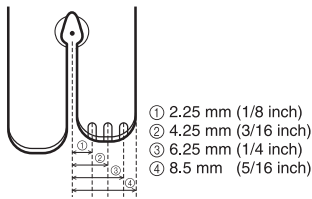

## CAUTION

- Be sure to turn the handwheel slowly in your direction before sewing and make sure that the needle is not contacting the straight stitch foot and straight stitch needle plate.

- 10 Start sewing.

\* After sewing, make sure to remove the straight stitch needle plate and the straight stitch foot, and reinstall the regular needle plate, the needle plate cover and the presser foot "J".



### Memo

To prevent puckering on fine fabrics, use a fine needle, size 75/11, and a short stitch length. For heavier fabrics, use a heavier needle, size 90/14, and longer stitches.

## Basting

- Press , and then attach presser foot "J".
- Press the "Reverse/Reinforcement Stitch" button to sew reinforcement stitches at the beginning of the stitching.

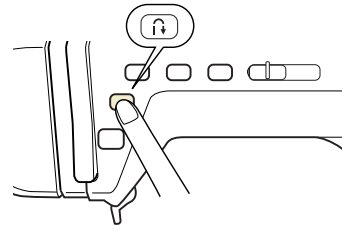

### Memo

The stitch length can be set between 5 mm and 30 mm (approx. 3/16 and 1-3/16 inches).

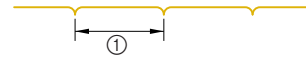

- ① Between 5 mm (approx. 3/16 inch) and 30 mm (approx. 1-3/16 inches)

- 3 Sew while lightly guiding the fabric.

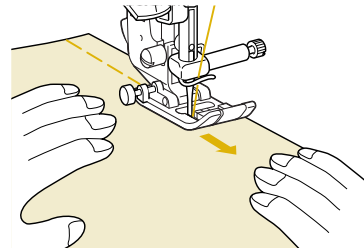

### Memo

This is easy to do if the foot controller is used (see page 41).

- 4 End the basting with reinforcement stitches.



3

Utility Stitches

## Darts Seams

- 1 Press , and then attach presser foot "J".
- 2 Press the "Reverse/Reinforcement Stitch" button to sew reverse stitches at the beginning of the stitching, and then sew from the wide end to the other end without stretching the fabric.

\* If the automatic reverse/reinforcement stitching setting is selected before sewing, reverse stitches will be sewn at the beginning of the stitching.

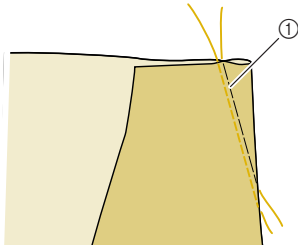

① Basting

- 3 Without sewing reverse stitches at the end of the stitching, pull out 50 mm (approx. 1-15/16 inches) of the threads, cut them, and then tie the two ends together.

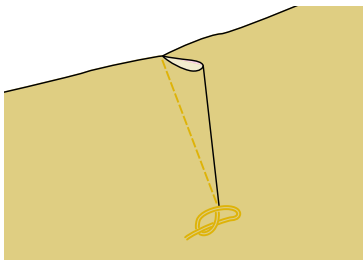

- 4 Insert the ends of the thread into the dart with a sewing needle.

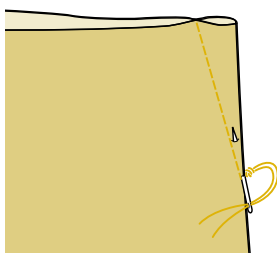

- 5 Iron the dart to one side.

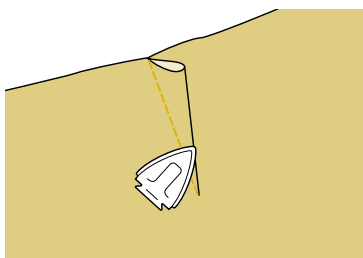

## Gathering

Sew gathers on sleeves, the waist of a gathered skirt, etc.

- 1 Select a straight stitch, and then attach presser foot "J".

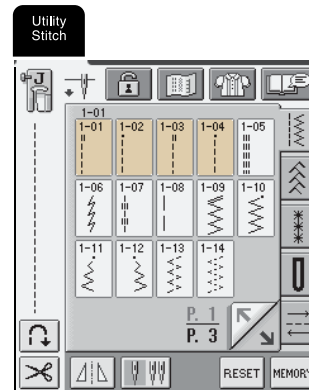

- 2 Set the stitch length to 4.0 mm (approx. 3/16 inch) and the thread tension to 2.0 (weaker tension).

### Memo

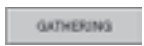
If you press , then , the stitch length is automatically set to 4.0 mm (approx. 3/16 inch) and the thread tension is automatically set to 2.0.

- 3 Pull out 50 mm (approx. 1-15/16 inches) of both the upper and bobbin threads (see "Pulling Up the Bobbin Thread" on page 28).

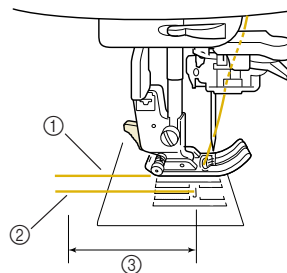

- ① Upper thread
- ② Bobbin thread
- ③ 50 mm (approx. 1-15/16 inches)

- 4 Sew a row of straight stitches along each side of the seam line, pull out 50 mm (1-15/16 inches) of the upper and bobbin threads, and then cut the threads.

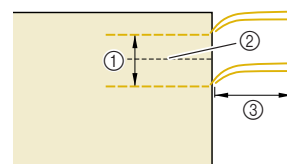

- ① 10 to 15 mm (approx. 3/8 to 9/16 inch)
- ② Seam line
- ③ 50 mm (approx. 1-15/16 inches)

- 5** Pull the bobbin threads to create the desired amount of gathering, and then tie the threads.

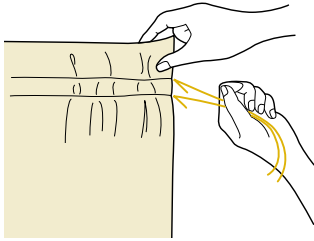

- 6** Smooth the gathers by ironing them.

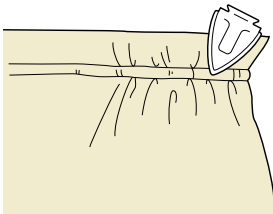

- 7** Sew along the seam line, and then remove the basting stitch.

## Flat Fell Seams

Use flat fell seams to reinforce seams and finish edges neatly.

- 1** Press , and then attach presser foot "J".
- 2** With the surfaces of the two pieces of fabric facing each other, sew the seam line, and then cut off half the seam allowance from the side on which the flat fell seam will lie.

\* If the automatic reverse/reinforcement stitching and automatic thread cutting settings are selected before sewing, reverse stitches will automatically be sewn at the beginning and end of the stitching and the thread will be cut.

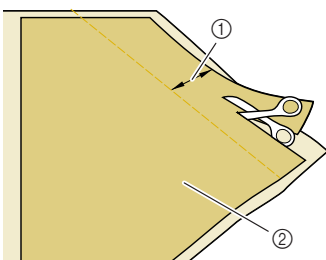

- ① About 12 mm (approx. 1/2 inch)  
② Wrong side of fabric

- 3** Spread out the fabric along the seam line.

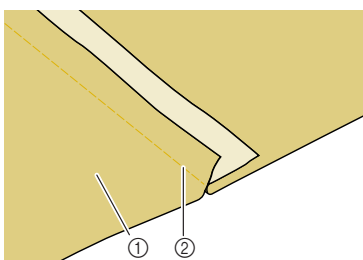

- ① Wrong side of fabric  
② Seam line

- 4** Lay both seam allowances on the side of the shorter one (cut seam allowance) and iron them flat.

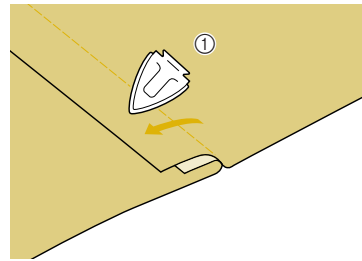

- ① Wrong side of fabric

- 5** Fold the longer seam allowance around the shorter one, and then sew along the edge of the fold.

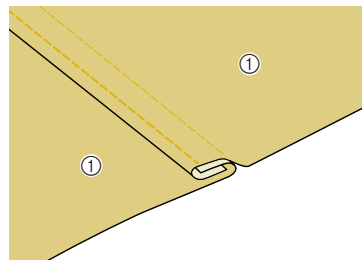

- ① Wrong side of fabric

Finished flat fell seam

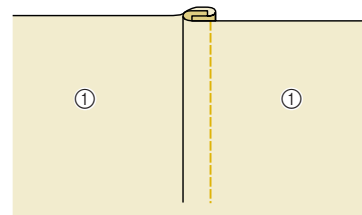

- ① Surface of fabric



3

Utility Stitches

## Pintucks

Use pin tucks to decorate blouses.

- 1 Mark the positions of the folds on the wrong side of the fabric.

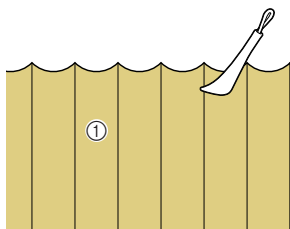

① Wrong side of fabric

- 2 Turn the fabric over, and then iron only the folds with the tip of the iron.

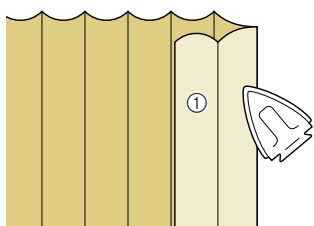

① Surface of fabric

- 3 Press , and then attach presser foot "I".

- 4 Attach the pin on the right side of presser foot "I" to the presser foot holder, and then sew along the folds.

\* If the automatic reverse/reinforcement stitching and automatic thread cutting settings are selected before sewing, reverse stitches will automatically be sewn at the beginning and end of the stitching and the thread will be cut.

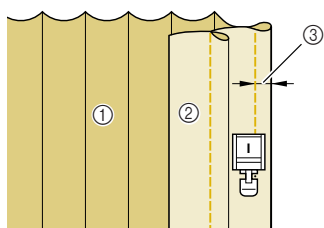

① Wrong side of fabric  
② Surface of fabric  
③ Width of pin tuck

- 5 Iron the folds in the same direction.

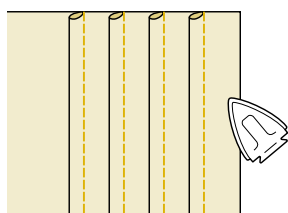

# Zigzag Stitches

Zigzag stitches are useful for a variety of applications, including overcasting and sewing appliqués and patchwork.



**Note**

When using the twin needle (see page 32), be sure to attach presser foot “J”.

Stitch Key	Stitch Name	Presser Foot	Applications	Stitch Width [mm (inch)]		Stitch Length [mm (inch)]		Twin Needle
				Auto.	Manual	Auto.	Manual	
	Zigzag stitch (Middle)		For overcasting, mending. Reverse stitch is sewn while pressing “Reverse/Reinforcement Stitch” button.	<b>3.5 (1/8)</b>	0.0 - 7.0 (0 - 1/4)	<b>1.4 (1/16)</b>	0.0 - 4.0 (0 - 3/16)	OK (J)
	Zigzag stitch (Middle)		For overcasting, mending. Reinforcement stitch is sewn while pressing “Reverse/Reinforcement Stitch” button.	<b>3.5 (1/8)</b>	0.0 - 7.0 (0 - 1/4)	<b>1.4 (1/16)</b>	0.0 - 4.0 (0 - 3/16)	OK (J)
	Zigzag stitch (Right)		Start from right needle position, zigzag sew at left.	<b>3.5 (1/8)</b>	2.5 - 5.0 (3/32 - 3/16)	<b>1.4 (1/16)</b>	0.3 - 4.0 (1/64 - 3/16)	OK (J)
	Zigzag stitch (Left)		Start from left needle position, zigzag sew at right.	<b>3.5 (1/8)</b>	2.5 - 5.0 (3/32 - 3/16)	<b>1.4 (1/16)</b>	0.3 - 4.0 (1/64 - 3/16)	OK (J)



Utility Stitches

- 1 Select a stitch, and then attach presser foot “J”.

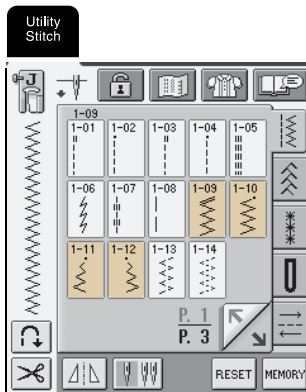

**Memo**

“■” at the beginning of the stitch shown on the key indicates that reverse stitches are sewn when the “Reverse/Reinforcement Stitch” button is pressed.  
 “•” at the beginning of the stitch shown on the key indicates that reinforcement stitches are sewn when the “Reverse/Reinforcement Stitch” button is pressed.

■ **Overcasting**

Sew while making sure that the needle drops slightly off the edge of the fabric.

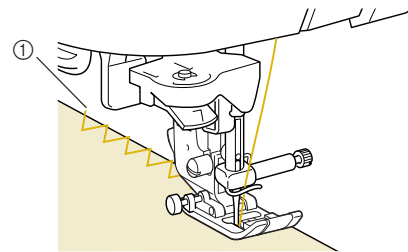

① Needle drop point

■ **Appliqués**

Attach the appliqué using a temporary spray adhesive or basting, and then sew along the edge of the appliqué, making sure that the needle drops slightly off the edge.

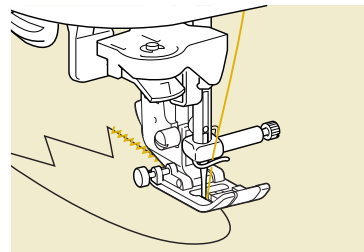

**■ Patchwork (Crazy Quilts)**

Turn back the desired width of fabric, place it over a different piece of fabric, and then sew the two fabric pieces together so the stitching bridges both pieces.

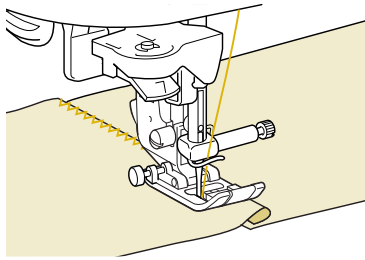

**■ Sewing Curves**

Shorten the stitch length setting to obtain a fine stitch. Sew slowly, keeping the seams parallel with the fabric edge as you guide the fabric around the curve.

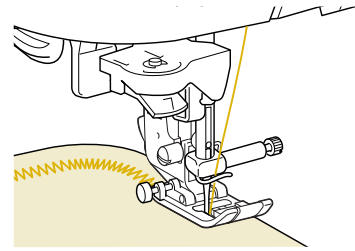

**Elastic Zigzag Stitches**

Use elastic zigzag stitches for a wide variety of applications, including overcasting, tape attaching, and darning.

Stitch Key	Stitch Name	Presser Foot	Applications	Stitch Width [mm (inch)]		Stitch Length [mm (inch)]		Twin Needle
				Auto.	Manual	Auto.	Manual	
	<b>2 step elastic zigzag</b>		Overcasting (medium weight and stretch fabrics), tape and elastic	<b>5.0 (3/16)</b>	1.5 - 7.0 (1/16 - 1/4)	<b>1.0 (1/16)</b>	0.2 - 4.0 (1/64 - 1/16)	OK (J)
	<b>3 step elastic zigzag</b>		Overcasting (medium, heavyweight and stretch fabrics), tape and elastic	<b>5.0 (3/16)</b>	1.5 - 7.0 (1/16 - 1/4)	<b>1.0 (1/16)</b>	0.2 - 4.0 (1/64 - 1/16)	OK (J)

**1** Select a stitch, and then attach presser foot “J”.

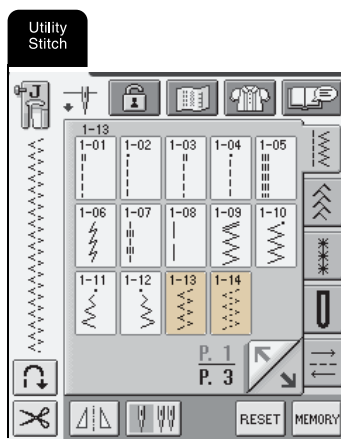

**■ Tape attaching**

Stretch the tape flat. While stretching the tape flat, sew the tape to the fabric.

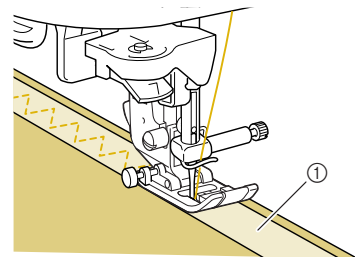

① Elastic tape

**■ Overcasting**

Use this stitch to sew overcasting on the edge of stretch fabrics. Sew while making sure that the needle drops slightly off the edge of the fabric.

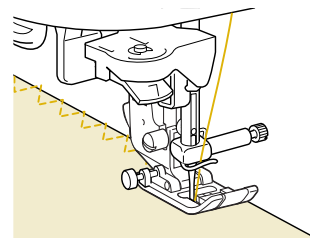









## Overcasting

Sew overcasting at the beginning and end of seams for skirts or pants, and at the beginning and end of all cuttings. Depending on the selected stitch, use presser foot "G" or "J" or the side cutter attachment (sold separately).

### Overcasting Using Presser Foot "G"

Stitch Key	Stitch Name	Presser Foot	Applications	Stitch Width [mm (inch)]		Stitch Length* [mm (inch)]		Twin Needle
				Auto.	Manual	Auto.	Manual	
	Overcasting stitch		Reinforcing of light and medium weight fabrics	3.5 (1/8)	2.5 - 5.0 (3/32 - 3/16)	2.0 (1/16)	1.0 - 4.0 (1/16 - 3/16)	NO
	Overcasting stitch		Reinforcing of heavyweight fabric	5.0 (3/16)	2.5 - 5.0 (3/32 - 3/16)	2.5 (3/32)	1.0 - 4.0 (1/16 - 3/16)	NO
	Overcasting stitch		Reinforcing of medium, heavyweight and easily frayed fabrics or decorative stitching.	5.0 (3/16)	3.5 - 5.0 (1/8 - 3/16)	2.5 (3/32)	1.0 - 4.0 (1/16 - 3/16)	NO

- 1 Select a stitch, and then attach presser foot "G".

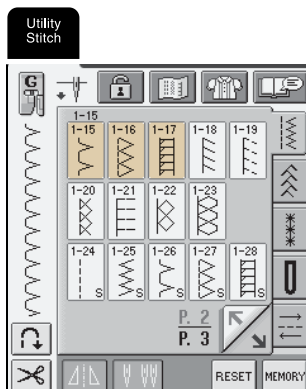

- 2 Lower the presser foot so that the presser foot guide is flush against the edge of the fabric.

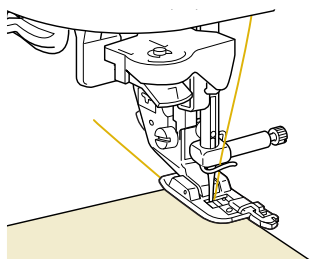

- 3 Sew along the presser foot guide.

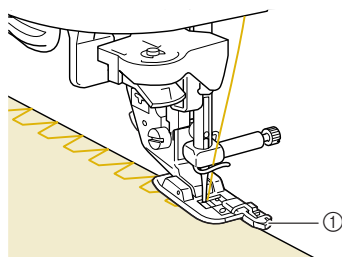

① Presser foot guide

### CAUTION

- After the stitch width is adjusted, turn the handwheel toward you by hand and check that the needle does not touch the presser foot. If the needle hits the presser foot, the needle may break and cause injury.

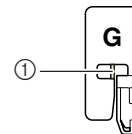

- ① The needle should not touch
- If the presser foot is raised to its highest level, the needle may strike the presser foot.



3

Utility Stitches

## Overcasting Using Presser Foot “J”

Stitch Key	Stitch Name	Presser Foot	Applications	Stitch width [mm (inch.)]		Stitch length [mm (inch.)]		Twin needle
				Auto.	Manual	Auto.	Manual	
	Overcasting stitch		Reinforced seaming of stretch fabric	5.0 (3/16)	0.0 - 7.0 (0 - 9/32)	2.5 (3/32)	0.5 - 4.0 (1/32 - 3/16)	OK (J)
	Overcasting stitch		Reinforcing of medium stretch fabric and heavyweight fabric, decorative stitching	5.0 (3/16)	0.0 - 7.0 (0 - 9/32)	2.5 (3/32)	0.5 - 4.0 (1/32 - 3/16)	OK (J)
	Overcasting stitch		Reinforcement of stretch fabric or decorative stitching	4.0 (3/16)	0.0 - 7.0 (0 - 1/4)	4.0 (3/16)	1.0 - 4.0 (1/16 - 3/16)	OK (J)
	Overcasting stitch		Stretch knit seam	5.0 (3/16)	0.0 - 7.0 (0 - 1/4)	4.0 (3/16)	1.0 - 4.0 (1/16 - 3/16)	NO
	Single diamond overcast		Reinforcement and seaming stretch fabric	6.0 (15/64)	1.0 - 7.0 (1/16 - 1/4)	3.0 (1/8)	1.0 - 4.0 (1/16 - 3/16)	OK (J)
	Single diamond overcast		Reinforcement of stretch fabric	6.0 (15/64)	1.0 - 7.0 (1/16 - 1/4)	1.8 (1/16)	1.0 - 4.0 (1/16 - 3/16)	OK (J)

**1** Select a stitch, and then attach presser foot “J”.

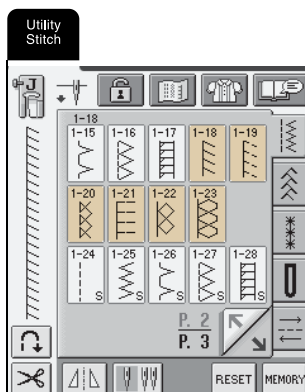

**2** Sew while making sure that the needle drops slightly off the edge of the fabric.



### Memo

For best results when sewing stretch fabrics, decrease the pressure of the presser foot.

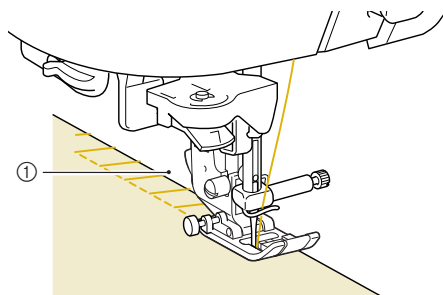

① Needle drop point

## Overcasting Using the Optional Side Cutter

By using the side cutter, you can do overcasting while cutting the fabric.

### CAUTION

- Make sure to only select one of the stitches listed below. Using another stitch may cause the needle to hit the presser foot and break, possibly causing injury.



#### Memo

Do not use the needle threader when the side cutter is attached. Thread the needle manually, or only attach the side cutter after threading the needle using the needle threader.

Stitch	Stitch name	Presser foot	Applications	Stitch width [mm (inch.)]		Stitch length [mm (inch.)]		Twin needle
				Auto.	Manual	Auto.	Manual	
	With side cutter		Straight stitch while cutting fabrics	0.0 (0)	0.0 - 2.5 (0 - 3/32)	2.5 (3/32)	0.2 - 5.0 (1/64 - 3/16)	NO
	With side cutter		Zigzag stitch while cutting fabrics	3.5 (1/8)	3.5 - 5.0 (1/8 - 3/16)	1.4 (1/16)	0.0 - 4.0 (0 - 3/16)	NO
	With side cutter		Overcasting stitch while cutting fabrics	3.5 (1/8)	3.5 - 5.0 (1/8 - 3/16)	2.0 (1/16)	1.0 - 4.0 (1/16 - 3/16)	NO
	With side cutter		Overcasting stitch while cutting fabrics	5.0 (3/16)	3.5 - 5.0 (1/8 - 3/16)	2.5 (3/32)	1.0 - 4.0 (1/16 - 3/16)	NO
	With side cutter		Overcasting stitch while cutting fabrics	5.0 (3/16)	3.5 - 5.0 (1/8 - 3/16)	2.5 (3/32)	1.0 - 4.0 (1/16 - 3/16)	NO

- Follow the steps on page 34 to remove the presser foot.
- Position the fork on the side cutter's operating lever onto the needle clamp screw.

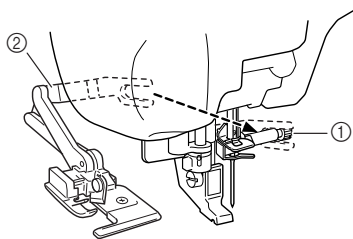

- Needle clamp screw
- Operating lever



#### Memo

Make sure that the fork of the operating lever is set onto the needle clamp screw firmly.

- Position the side cutter so that the side cutter pin is aligned with the notch in the presser foot holder, and then lower the presser foot.

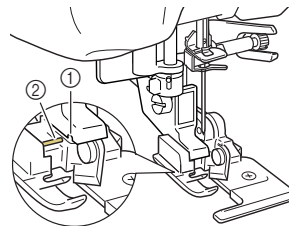

- Notch in presser foot holder
- Pin

→ The side cutter is attached.



3

Utility Stitches

**4** Select a stitch.

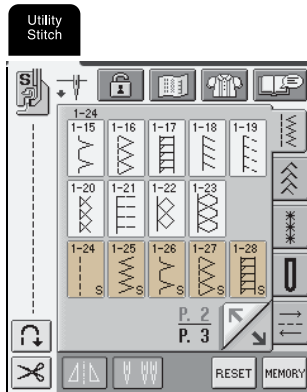

**5** Make a cut of approximately 20 mm (approx. 3/4 inch) in the fabric.

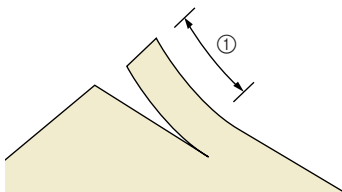

① 20 mm (approx. 3/4 inch)

**6** Position the fabric so that the right side of the cut is on top of the guide plate and the left side of the cut is underneath the presser foot.

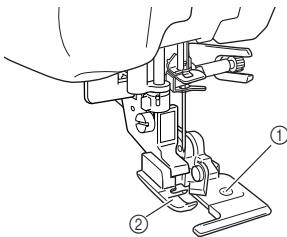

① Guide plate (lower knife)  
② Presser foot

**7** Thread the needle manually and pull out a long section of the upper thread. Pass it below the presser foot and pull it out in the fabric feed direction.

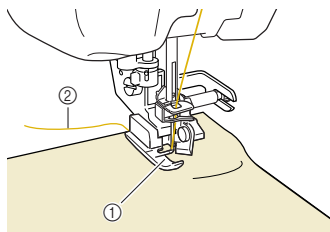

① Presser foot  
② Upper thread

**8** Start sewing.

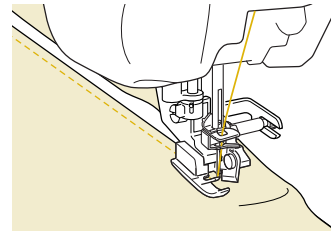

→ A seam allowance is cut while the stitching is sewn.



**Note**

If the width has been adjusted, turn the handwheel by hand to check that the needle does not touch the side cutter. If the needle touches the side cutter, it might cause the needle to break.

**■ When Sewing Straight Stitches While Using the Side Cutter**

The seam margin should be approximately 5 mm (approx. 3/16 inch).

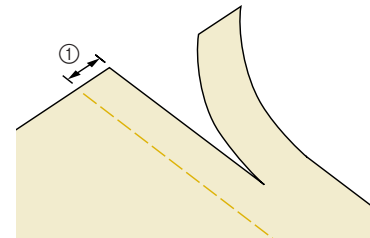

① Seam margin



**Memo**

- The fabric will not be cut if the whole fabric is simply spread out underneath the presser foot guide plate. Set the fabric as explained in step 6 from the previous section, and then start sewing.

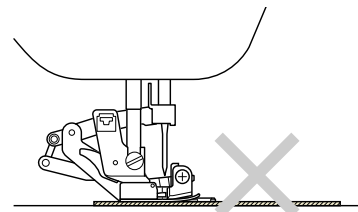

- One layer of 13 oz. denim can be cut.
- Clean the side cutter after use to avoid having dust and scraps of thread build up on it.
- Add a small amount of oil as required to the cutting edge of the cutter.

## Quilting

You can make beautiful quilts quickly and easily with this machine. When making a quilt, you will find it convenient to use the knee lifter and foot controller to free your hands for other tasks (see "Using the Foot Controller" on page 41 and/or see "Using the Knee Lifter" on page 42).

Patterns with "P" or "Q" in the lower-right corner of the key are intended for quilting.

Stitch Key	Stitch Name	Presser Foot	Applications	Stitch width [mm (inch.)]		Stitch length [mm (inch.)]		Twin needle
				Auto.	Manual	Auto.	Manual	
	Piecing stitch (Right)		Piecework/patchwork 6.5 mm (approx. 1/4 inch) right seam allowance	5.5 (7/32)	0.0 - 7.0 (0 - 1/4)	2.0 (1/16)	0.2 - 5.0 (1/64 - 3/16)	NO
	Piecing stitch (Middle)		Piecework/patchwork	—	—	2.0 (1/16)	0.2 - 5.0 (1/64 - 3/16)	NO
	Piecing stitch (Left)		Piecework/patchwork 6.5 mm (approx. 1/4 inch) left seam allowance	1.5 (1/16)	0.0 - 7.0 (0 - 1/4)	2.0 (1/16)	0.2 - 5.0 (1/64 - 3/16)	NO
	Hand-look quilting		Quilting stitch made to look like hand quilting stitch	0.0 (0)	0.0 - 7.0 (0 - 1/4)	2.5 (3/32)	1.0 - 4.0 (1/16 - 3/16)	NO
	Quilting appliqué zigzag stitch		Zigzag stitch for quilting and sewing on appliqué quilt pieces	3.5 (1/8)	0.0 - 7.0 (0 - 1/4)	1.4 (1/16)	0.0 - 4.0 (0 - 3/16)	NO
	Quilting appliqué stitch		Quilting stitch for invisible appliqué or attaching binding	1.5 (1/16)	0.5 - 5.0 (1/64 - 3/16)	1.8 (1/16)	1.0 - 4.0 (1/16 - 3/16)	NO
	Quilting stippling		Background quilting	7.0 (1/4)	1.0 - 7.0 (1/16 - 1/4)	1.6 (1/16)	1.0 - 4.0 (1/16 - 3/16)	NO

### ■ Piecing

Sewing two pieces of fabric together is called piecing. When cutting pieces for quilt blocks, make sure the seam allowance is 6.5 mm (approx. 1/4 inch).

#### Memo

To change the width of the seam allowance, adjust the stitch width to change the needle position.

- 1 Press or , and then attach presser foot "J".
- 2 Sew with the edge of the fabric aligned with the side of the presser foot.

Stitch width when is selected

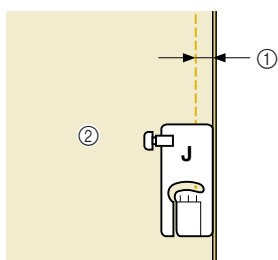

- ① 6.5 mm (approx. 1/4 inch)
- ② Align with right side of presser foot.

Stitch width when is selected

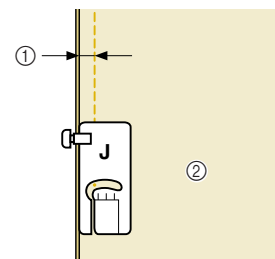

- ① 6.5 mm (approx. 1/4 inch)
- ② Align with left side of presser foot.

#### Memo

- The stitch width refers to the needle position, not the width of the seam allowance.
- To change the needle position, press or in the width display.
- After the stitch length and needle position are set as desired, the settings can be saved (see page 52).



3

Utility Stitches

## ■ Quilting

Sewing together the quilt top, batting, and backing is called quilting. You can sew the quilt with the walking foot to keep the quilt top, batting, and backing from sliding. The walking foot has a set of feed dogs that move together with the feed dogs in the needle plate during sewing.

- 1 Follow the steps on page 34 to remove the presser foot.
- 2 Loosen the screw of the presser foot holder to remove the presser foot holder.

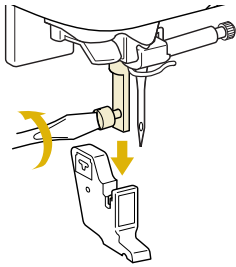

- 3 Set the operation lever of the walking foot so that the needle clamp screw is set between the fork, and position the walking foot on the presser foot bar.

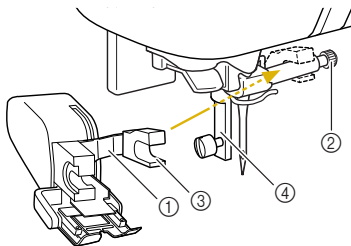

- ① Operation lever
- ② Needle clamp screw
- ③ Fork
- ④ Presser foot bar

- 4 Lower the presser foot lever. Tighten the screw securely with the screwdriver.

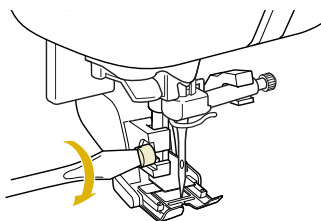

- 5 Place one hand on each side of the presser foot to hold the fabric secure while sewing.



### Memo

- Sew at slow to medium speed.
- Do not sew in reverse or use stitches that require side ways or reverse feeding.
- Always check to be sure that your quilting surface is securely basted before beginning to sew. Specialized machine quilt needles and threads are also available for machine quilting.

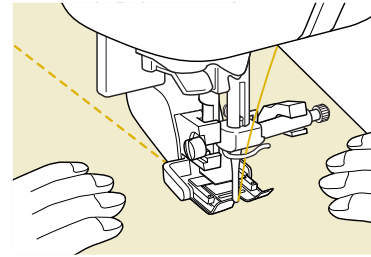

## ■ Appliqués

The seam will blend in if transparent nylon thread is used for the upper thread.

- 1 Trace the pattern onto the appliqué fabric, and then cut around it.

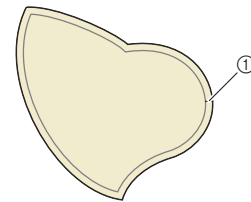

- ① Seam allowance: 3 to 5 mm

- 2 Cut a piece of thick paper or stabilizer to the finished size of the appliqué design, place it on the back of the appliqué, and then fold over the seam allowance using an iron.

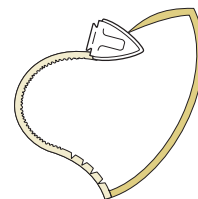

- 3 Turn the appliqué over, and attach the stabilizer with basting pins or a basting stitch.

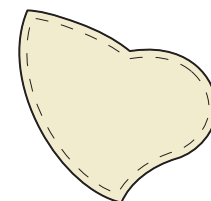

- 4 Press , and then attach presser foot "J".

- 5 Check the needle drop point, and then sew along the edge of the appliqué while making sure that the needle drops slightly off the edge of the fabric.

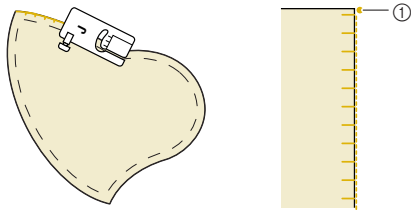



① Needle drop point

### CAUTION

- Be careful that the needle does not strike a basting pin during sewing. Striking a pin can cause the needle to break, resulting in injury.

### Satin Stitching

Use the foot controller to sew with satin stitches. If you set the speed control slide to control the stitch width, you can make subtle changes in the stitch width during sewing.

- 1 Connect the foot controller (see page 41).
- 2 Press , and then attach presser foot "J".
- 3 Press  in the length display to shorten the stitch length.

### Memo

A stitch length between 0.3 and 0.5 mm (approx. 1/64 and 1/32 inch) is best for satin stitches, although this range varies depending on the type of fabric and thickness of thread used.

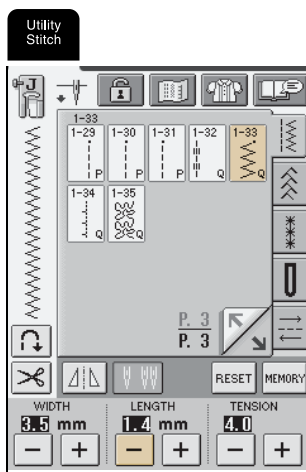

- 4 Press .

\* Change the sewing speed controller to a stitch width controller.

- 5 Set "WIDTH CONTROL" to "ON". The sewing speed will be adjusted using the foot controller.

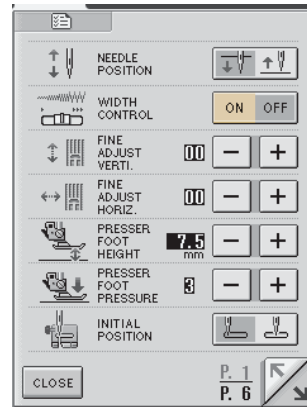

- 6 Press .

- 7 While sewing, slide the sewing speed controller to adjust the stitch width.

### Memo

- Slide the controller to the left to make the width narrower. Slide the controller to the right to make the width wider.
- The stitch width is adjusted equally from the center needle position.

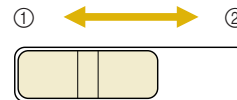

- ① Narrower
- ② Wider



- 8 When you are finished sewing, set "WIDTH CONTROL" back to "OFF".



3

Utility Stitches

## Free-motion Quilting

With free-motion quilting, the feed dogs can be lowered (using the feed dog position switch) so that the fabric can be moved freely in any direction. The quilting foot is needed for free-motion quilting. We recommend attaching the foot controller and sewing at a consistent speed.

### Memo

In order to sew a balanced stitch, it may be necessary to lower the upper thread tension (see page 45) or to loosen the presser foot pressure at the setting screen (see page 20). Test with a sample piece.

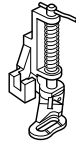

- 1 Select .
- 2 Remove the presser foot holder (see page 68).
- 3 Align the quilting foot with the lower-left side of the presser bar.

### Memo

The pin on the quilting foot should be positioned over the needle clamp screw.

- 4 Hold the quilting foot in place with your right hand, and then tighten the presser foot holder screw using the screwdriver in your left hand.

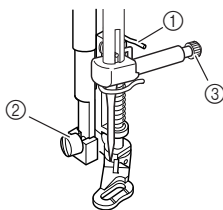

- 1 Pin on quilting foot
- 2 Presser foot holder screw
- 3 Needle clamp screw

## CAUTION

- Be sure to securely tighten the screws with the screwdriver. Otherwise, the needle may touch the presser foot, causing it to bend or break.

- 5 Lower the feed dog position switch, located at the rear of the base of the machine, to .

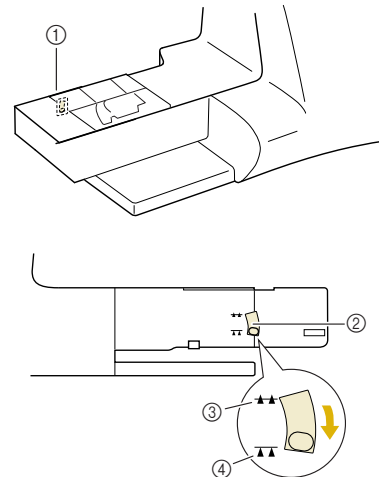

- 1 Rear of machine
- 2 Feed dog position switch (as seen from the rear of the machine)
- 3 Up
- 4 Down

- 6 Use both hands to stretch the fabric taut, and then move the fabric at a regular pace in order to sew uniform stitches roughly 2.0-2.5 mm (approx. 1/16 - 3/32 inch) in length.

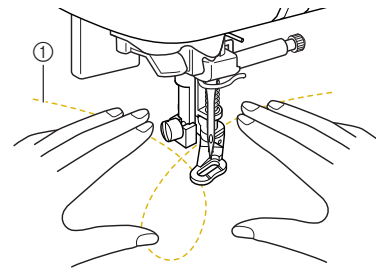

- 1 Stitch
- Reinforcement stitches are sewn at the beginning and end of sewing.

- 7 After sewing is finished, raise the feed dog position switch to  to raise the feed dogs. Reset your machine to normal setting.





### Memo

Normally, the feed dog position switch is in the up position.



## Blind Hem Stitches

Select a blind hem stitch to sew the hems or cuffs of dresses, blouses, pants, or skirts.

Stitch Key	Stitch Name	Presser Foot	Applications	Stitch Width [mm (inch)]		Stitch Length [mm (inch)]		Twin Needle
				Auto.	Manual	Auto.	Manual	
	Blind hem stitch		Hemming woven fabrics	00	3 ← → 3	2.0 (1/16)	1.0 - 3.5 (1/16 - 1/8)	NO
	Blind hem stitch stretch		Hemming stretch fabric	00	3 ← → 3	2.0 (1/16)	1.0 - 3.5 (1/16 - 1/8)	NO

### 1 Select a stitch pattern.



#### Memo

For best results when sewing stretch fabrics, decrease the pressure of the presser foot.

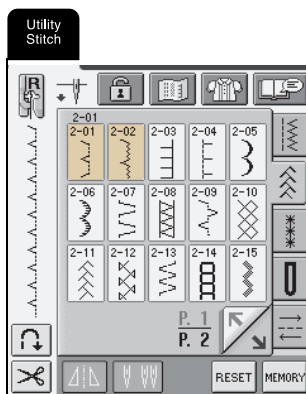

### 2 Place the fabric wrong side up, and then fold and baste the fabric as shown.

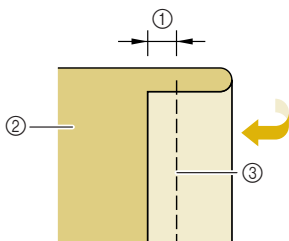

- ① 5 mm
- ② Wrong side of fabric
- ③ Basting

### 3 Fold the fabric again, as shown.

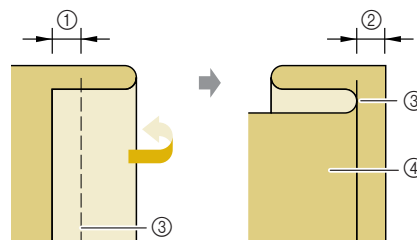

- ① 5 mm
- ② 5 mm
- ③ Basting
- ④ Wrong side of fabric

### 4 Attach presser foot "R", and then lower the presser foot so that the presser foot guide is flush against the fold of the fabric.

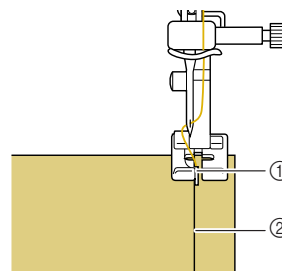

- ① Presser foot guide
- ② Fold

### 5 Sew while keeping the fold in the fabric against the presser foot guide.

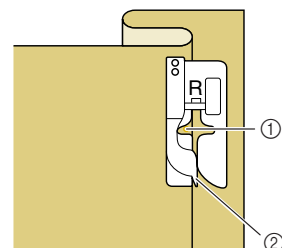

- ① Needle position
- ② Presser foot guide



3

Utility Stitches

**6 Remove the basting, and then turn over the fabric.**

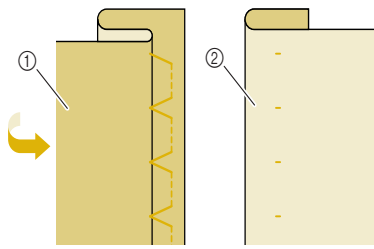

- ① Wrong side of fabric
- ② Surface of fabric

**Memo**

Blind hem stitches cannot be sewn if the needle does not catch the fold on the left side. However, if the needle catches too much of the fold, the fabric cannot be unfolded and too much of the seam will appear on the surface of the fabric, leaving an unattractive finish. If either of these occur, follow the instructions below to correct the problem.

**■ If the Needle Does Not Catch the Fold**

Press **-** in the width display so that the needle slightly catches the fold.

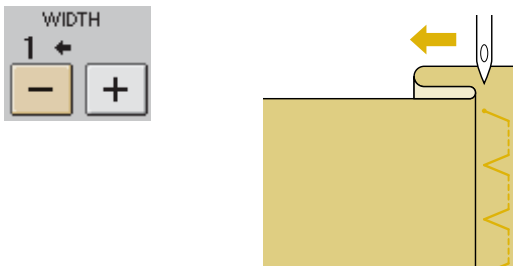

**■ If the Needle Catches Too Much of the Fold**

Press **+** in the width display so that the needle slightly catches the fold.

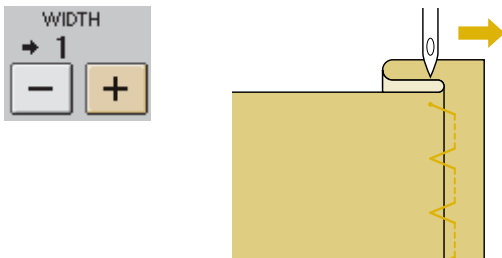

**Appliqués**

**1 Use a temporary spray adhesive or basting to attach the appliqué to the fabric.**

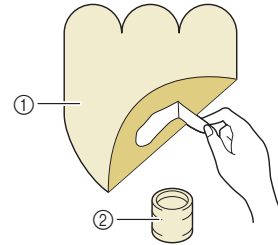

- ① Appliqué
- ② Fabric glue

**2 Press**  **or**  **.**

**Memo**

- Adjust the stitch width and length according to the shape, size and fabric quality of the appliqué (see page 44).
- For details on the stitch patterns, refer to the “STITCH SETTING CHART” at the end of this manual.

**3 Attach presser foot “J”, and then sew along the edge of the appliqué, making sure that the needle drops slightly off the edge.**

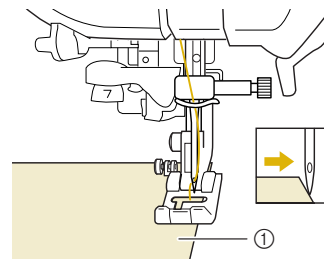

- ① Appliqué

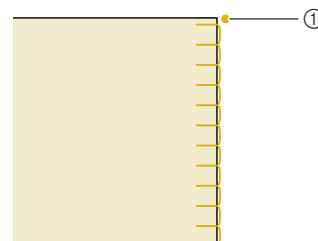

- ① Needle drop point

### ■ Sewing Sharp Curves

Stop the machine with the needle in the fabric outside the appliqué. Raise the presser foot and turn the fabric a little bit at a time while sewing for an attractive finish to the seam.

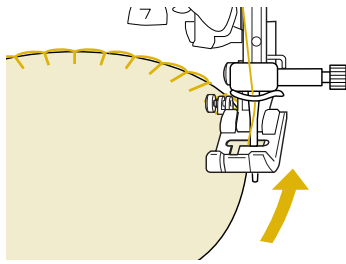

## Shell Tuck Stitching

The arched tuck that looks like shells lined up in a row is called a shell tuck. In addition to edging, this decorative stitching can be used on the neckline or sleeves of dresses and blouses.

- 1 Press .



#### Memo

For details on the stitch patterns, refer to the “STITCH SETTING CHART” at the end of this manual.

- 2 Increase the thread tension for an attractive scalloped finish to the shell tuck stitching.



#### Memo

If the thread tension is too loose, the shell tuck stitching will not scallop.

- 3 Fold the fabric in half along the bias.

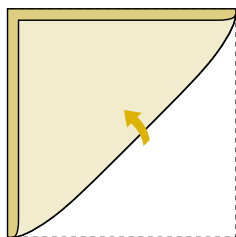

#### Note

Use a thin fabric.

- 4 Attach presser foot “J”, and then sew along the edge of the fabric, making sure that the needle drops slightly off the edge.

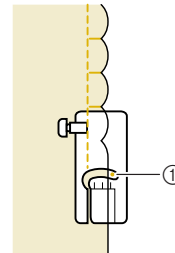
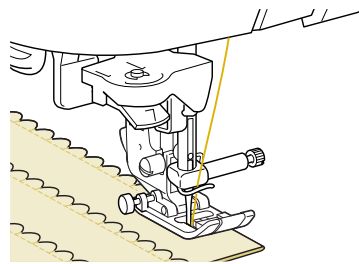

- ① Needle drop point

- 5 Unfold the fabric, and then iron the tucks down to one side.

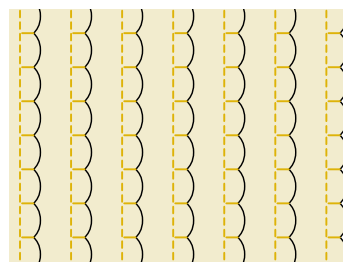

## Scalloping

Scallop stitching (wave-shaped running stitching) can be used to decorate the edges of blouse collars and handkerchiefs.

- 1 Press , and then attach presser foot “N”.



#### Memo

- If the automatic thread cutting setting is selected before sewing, the machine will automatically sew reinforcement stitches at the beginning of stitching. When the “Reverse/Reinforcement Stitch” button is pressed at the end of stitching, the machine will automatically sew reinforcement stitches and cut the thread.
- For best results, apply a temporary spray adhesive and iron the fabric before sewing.
- For details on the stitch patterns, refer to the “STITCH SETTING CHART” at the end of this manual.



3

Utility Stitches

- 2 Leave a seam when sewing the scallop stitches so that the pattern is not sewn directly on the edge of the fabric.



**Note**

Sew test stitches on the fabric before sewing on your project.

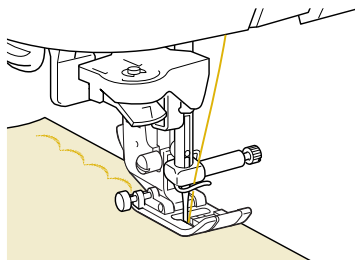

- 3 Trim along the seam, making sure not to cut the stitches.

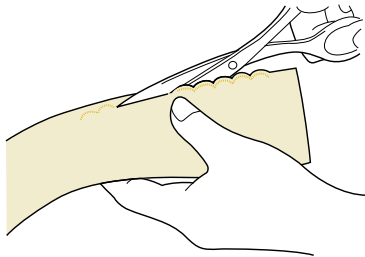

### Top Stitching

For a decorative effect in a crazy quilt, stitches can be sewn over a pressed seam allowance.

- 1 Select a straight stitch, and then attach presser foot "J".
- 2 Sew together two pieces of fabric with their surfaces facing each other, and then open the seam allowances.

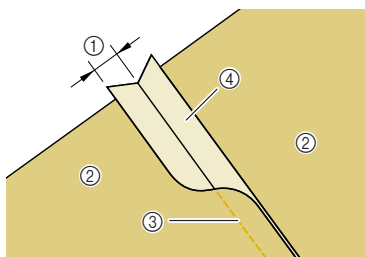

- ① 6.5 mm (1/4 inch)
- ② Wrong side of fabric
- ③ Straight stitch
- ④ Seam allowance

- 3 Turn the fabric over so that the surface faces up, and then sew over the seam with the center of the presser foot aligned with the seam.

\* Select one of the following stitch patterns.

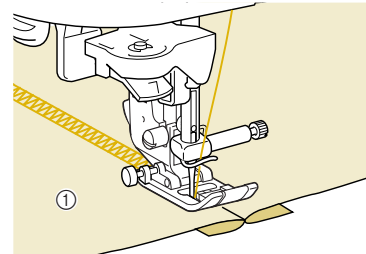

① Surface of fabric

### Smocking

The decorative stitching created by sewing or embroidering over gathers is called smocking. It is used to decorate the front of blouses or cuffs.

- 1 Select a straight stitch, and then attach presser foot "J".



**Note**

Make sure that the automatic reverse/reinforcement stitching and automatic thread cutting settings are not selected.

- 2 Set the stitch length to 4.0 mm (approx. 3/16 inch) and the thread tension to 2.0 (weaker tension).
- 3 Pull out 50 mm (approx. 1-15/16 inches) of both the upper and bobbin threads.
- 4 Sew stitching 10 mm (approx. 3/8 inch) apart.

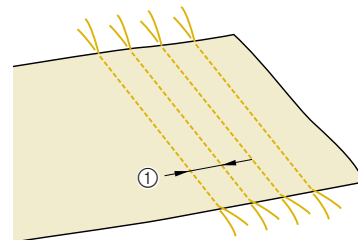

① Approximately 10mm (approx. 3/8 inch)

- 5** Pull the bobbin threads to create the desired amount of gather, and then smooth the gathers by ironing them.

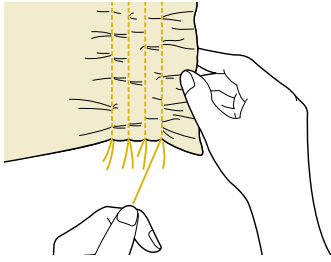

- 6** Press  or .



### Memo

For details on the stitch patterns, refer to the "STITCH SETTING CHART" at the end of this manual.

- 7** Sew between the straight stitches.

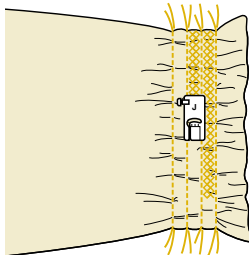

- 8** Pull out the straight stitch threads.

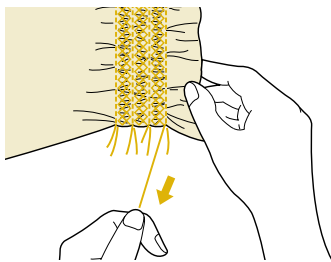



## Fagoting

Stitching across an open seam is called fagoting. It is used on blouses and children's clothing.

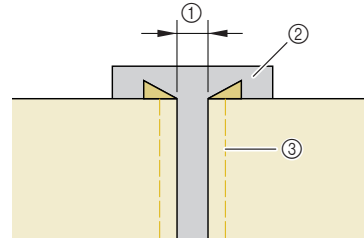
- 1** Separate the two pieces of fabric by about 4 mm (approx. 3/16 inch), and baste them onto thin paper.



- ① 4 mm  
② Thin paper  
③ Basting

- 2** Press  or , and then set the stitch width to the maximum (7.0 mm).



### Memo

For details on the stitch patterns, refer to the "STITCH SETTING CHART" at the end of this manual.

- 3** Attach presser foot "J", and then sew with the presser foot centered between the two pieces of fabric.



### Memo

This stitch is more decorative when thicker thread is used.

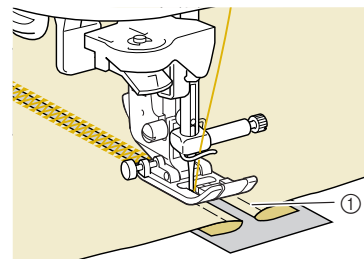

- ① Basting

- 4** When you are finished sewing, gently tear off the paper.



3

Utility Stitches

## Tape or Elastic Attaching

Elastic tape is sewn onto the fabric unstretched.

- 1 Select a straight stitch, and then attach presser foot "J".



### Note

Make sure that the automatic reverse/reinforcement stitching and automatic thread cutting settings are not selected.

- 2 Set the stitch length to 4.0 mm (approx. 3/16 inch) and the thread tension to 2.0 (weaker tension).
- 3 Pull out 50 mm (approx. 1-15/16 inches) of both the upper and bobbin threads (see "Pulling Up the Bobbin Thread" on page 28).

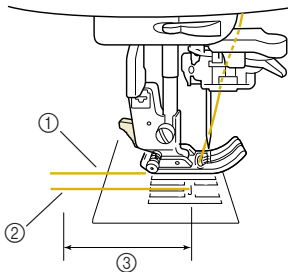

- ① Upper thread
- ② Bobbin thread
- ③ 50 mm

- 4 Sew two rows of straight stitches on the surface of the fabric, and then pull the bobbin threads to create the desired amount of gather.

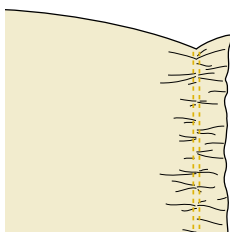

- 5 Pin the elastic tape to the wrong side of the fabric with the elastic tape evenly positioned on the gathers.

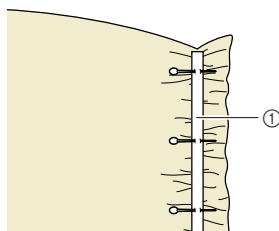

- ① Elastic tape

- 6 Press or .



### Note

For details on the stitch patterns, refer to the "STITCH SETTING CHART" at the end of this manual.

- 7 While pulling the elastic tape so that it is about the same length as the fabric, pull the fabric at the pin nearest the front of the presser foot with your right hand, and feed the fabric behind the presser foot with your left hand according to the feeding speed.



### Memo

This is easy to do if the foot controller is used.

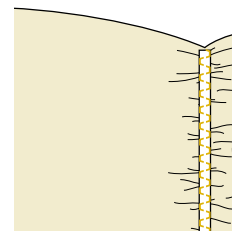
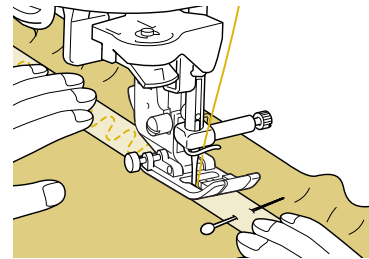

## CAUTION

- Be sure the needle does not strike a basting pin, or any other objects, during sewing. The thread could tangle or the needle could break, causing injury.

- 8 Pull out the threads for the straight stitches.

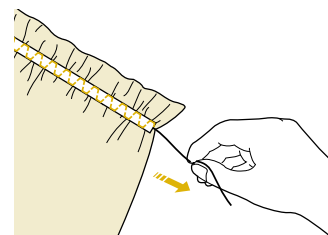

## Heirloom Stitching

By sewing with the wing needle (sold separately), the needle holes are enlarged, creating a lace-like decorative stitch.

This stitching is used to decorate tablecloths, hems, and shirt fronts.

### ■ Heirloom stitching/Hemstitching (1) (Daisy Stitch)

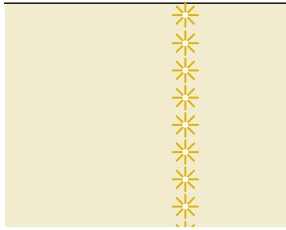

#### Note

For best results, use lightweight to medium weight homespun fabrics with a slight stretch.

### 1 Insert the wing needle (130/705H, size 100/16).



#### Note

The needle threader cannot be used. Manually pass the thread through the eye of the needle from the front. If the needle threader is used, damage to the machine may result.

### 2 Select a stitch, attach presser foot “N”, and then start sewing.

\* Select a stitch between 3-01 and 3-22.

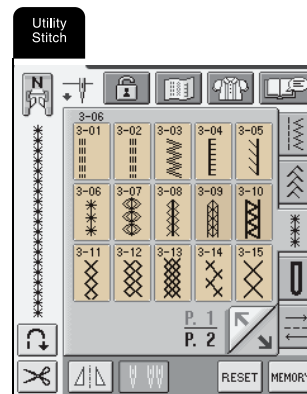

## ⚠ CAUTION

- The “Automatic Threading” button cannot be used. Thread the wing needle by hand, from front to back. Using the “Automatic Threading” button may result in damage to the machine.
- A more attractive finish can be obtained if you use a “130/705H Wing” needle when sewing these patterns. If using a wing needle and the stitch width has been set manually, check that the needle will not touch the presser foot by carefully rotating the handwheel before starting sewing.



#### Memo

For details on the stitch patterns, refer to the “STITCH SETTING CHART” at the end of this manual.

### ■ Heirloom stitching/Hemstitching (2) (Drawn Work (1))

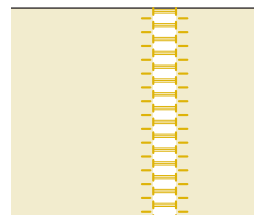

3

Utility Stitches

- 1 Pull out several threads from the fabric to leave a 3 mm (approx. 1/8 inch) area open.



**Memo**

For best result, use loosely woven fabrics.

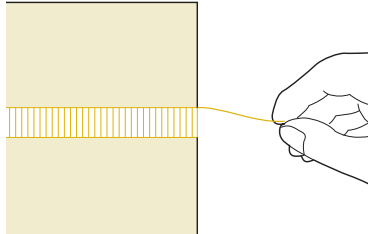

- 2 Press , and then attach presser foot "N".



**Memo**

For details on the stitch patterns, refer to the "STITCH SETTING CHART" at the end of this manual.

- 3 With the surface of the fabric facing up, sew along the right edge of the open area.

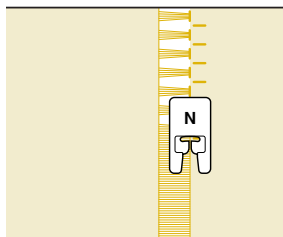

- 4 Press  to create a mirror image of the stitch.

- 5 Sew along the left edge of the open area so that the stitching looks symmetrical.

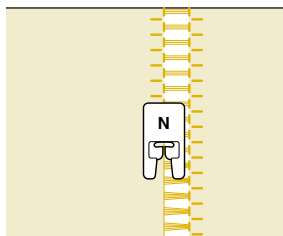

■ Heirloom stitching/Hemstitching (3) (Drawn Work (2))

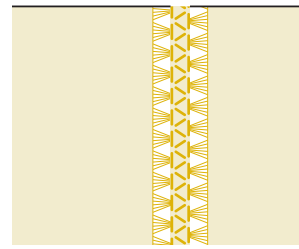

**Memo**

Drawn work can also be sewn using the wing needle (sold separately).

- 1 Pull out several threads from both sides of a 4 mm (approx. 3/16 inch) area left unopened, as shown in the illustration.

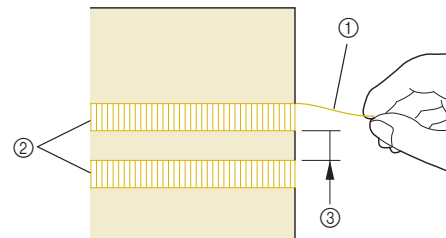

- ① Pulled out thread
- ② Pulled out area
- ③ Approximately 4 mm (approx. 3/16 inch) remaining

- 2 Press .



**Memo**

For details on the stitch patterns, refer to the "STITCH SETTING CHART" at the end of this manual.



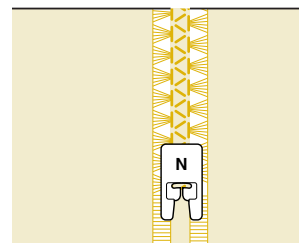

























- 3 Attach presser foot "N", and then sew along the center of the unopened area.





## Buttonhole Stitches

Select the desired buttonhole stitch according to your application and the size of the button.

Stitch Key	Stitch Name	Presser Foot	Applications	Stitch Width [mm (inch)]		Stitch Length [mm (inch)]		Twin Needle
				Auto.	Manual	Auto.	Manual	
	<b>Narrow rounded buttonhole</b>		Buttonhole on light to medium weight fabrics	<b>5.0</b> <b>(3/16)</b>	3.0 - 5.0 (1/8 - 3/16)	<b>0.4</b> <b>(1/64)</b>	0.2 - 1.0 (1/64 - 1/16)	NO
	<b>Wide round ended buttonhole</b>		Buttonholes with extra space for larger buttons	<b>5.5</b> <b>(7/32)</b>	3.5 - 5.5 (1/8 - 7/32)	<b>0.4</b> <b>(1/64)</b>	0.2 - 1.0 (1/64 - 1/16)	NO
	<b>Tapered round ended buttonhole</b>		Reinforced waist tapered buttonholes	<b>5.0</b> <b>(3/16)</b>	3.0 - 5.0 (1/8 - 3/16)	<b>0.4</b> <b>(1/64)</b>	0.2 - 1.0 (1/64 - 1/16)	NO
	<b>Round ended buttonhole</b>		Buttonholes with vertical bar tack in heavyweight fabrics	<b>5.0</b> <b>(3/16)</b>	3.0 - 5.0 (1/8 - 3/16)	<b>0.4</b> <b>(1/64)</b>	0.2 - 1.0 (1/64 - 1/16)	NO
	<b>Round ended buttonhole</b>		Buttonholes with bar tack	<b>5.0</b> <b>(3/16)</b>	3.0 - 5.0 (1/8 - 3/16)	<b>0.4</b> <b>(1/64)</b>	0.2 - 1.0 (1/64 - 1/16)	NO
	<b>Round double ended buttonhole</b>		Buttonholes for fine, medium to heavyweight fabrics	<b>5.0</b> <b>(3/16)</b>	3.0 - 5.0 (1/8 - 3/16)	<b>0.4</b> <b>(1/64)</b>	0.2 - 1.0 (1/64 - 1/16)	NO
	<b>Narrow squared buttonhole</b>		Buttonholes for light to medium weight fabrics	<b>5.0</b> <b>(3/16)</b>	3.0 - 5.0 (1/8 - 3/16)	<b>0.4</b> <b>(1/64)</b>	0.2 - 1.0 (1/64 - 1/16)	NO
	<b>Wide squared buttonhole</b>		Buttonholes with extra space for larger decorative buttons	<b>5.5</b> <b>(7/32)</b>	3.5 - 5.5 (1/8 - 7/32)	<b>0.4</b> <b>(1/64)</b>	0.2 - 1.0 (1/64 - 1/16)	NO
	<b>Stretch buttonhole</b>		Buttonholes for stretch or woven fabrics	<b>6.0</b> <b>(15/64)</b>	3.0 - 6.0 (1/8 - 15/64)	<b>1.0</b> <b>(1/16)</b>	0.5 - 2.0 (1/32 - 1/16)	NO
	<b>Heirloom buttonhole</b>		Buttonholes for heirloom and stretch fabrics	<b>6.0</b> <b>(15/64)</b>	3.0 - 6.0 (1/8 - 15/64)	<b>1.5</b> <b>(1/16)</b>	1.0 - 3.0 (1/16 - 1/8)	NO
	<b>Bound buttonhole</b>		The first step in making bound buttonholes	<b>5.0</b> <b>(3/16)</b>	0.0 - 6.0 (0 - 15/64)	<b>2.0</b> <b>(1/16)</b>	0.2 - 4.0 (1/64 - 3/16)	NO
	<b>Keyhole buttonhole</b>		Buttonholes in heavyweight or thick fabrics for larger flat buttons	<b>7.0</b> <b>(1/4)</b>	3.0 - 7.0 (1/8 - 1/4)	<b>0.5</b> <b>(1/32)</b>	0.3 - 1.0 (1/64 - 1/16)	NO
	<b>Tapered keyhole buttonhole</b>		Buttonholes in medium to heavy weight fabrics for larger flat buttons	<b>7.0</b> <b>(1/4)</b>	3.0 - 7.0 (1/8 - 1/4)	<b>0.5</b> <b>(1/32)</b>	0.3 - 1.0 (1/64 - 1/16)	NO
	<b>Keyhole buttonhole</b>		Buttonholes with vertical bar tack for reinforcement in heavyweight or thick fabrics	<b>7.0</b> <b>(1/4)</b>	3.0 - 7.0 (1/8 - 1/4)	<b>0.5</b> <b>(1/32)</b>	0.3 - 1.0 (1/64 - 1/16)	NO



3

Utility Stitches

Buttonholes are sewn from the front of the presser foot to the back, as shown below.

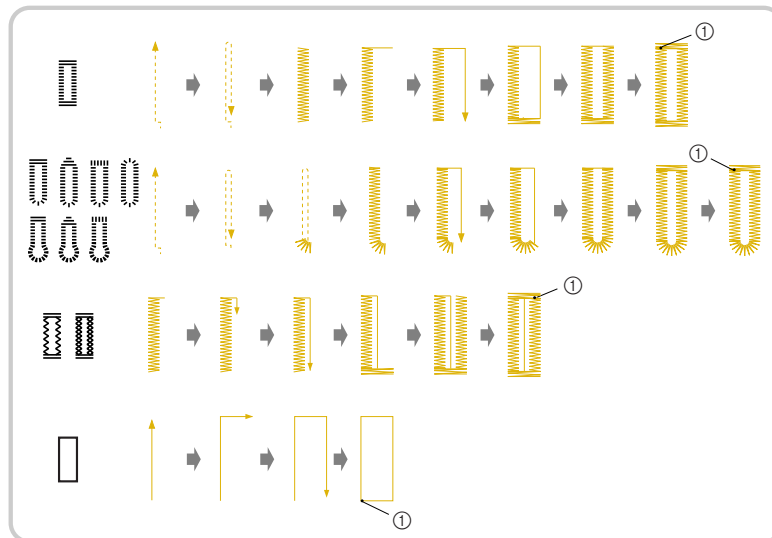

① Reinforcement stitching

- 1 Select a stitch, and then attach presser foot "A".
- 2 Mark the position and length of the buttonhole on the fabric.

**Memo**

The maximum buttonhole length is 28 mm (approx. 1-1/6 inches) (diameter + thickness of the button).

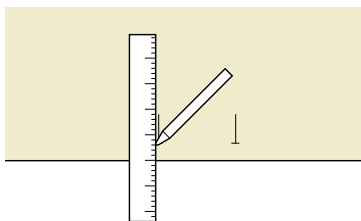

- 3 Pull out the button holder plate on the presser foot, and then insert the button that will be put through the buttonhole.

\* The size of the buttonhole is set by positioning the button in the button holder plate.

**Note**

Pass the thread under the presser foot.

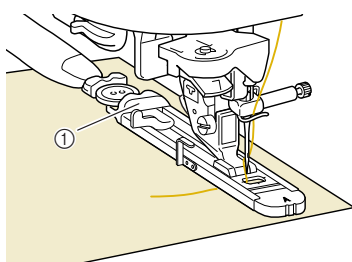

① Button holder plate

- 4 Hold the outside frame of the buttonhole foot toward the back with your finger, and then lower the presser foot so that the mark on the fabric aligns with the marks on the buttonhole foot.

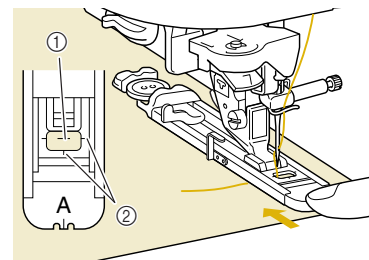

- ① Mark on fabric
- ② Marks on presser foot

**Note**

- Slide the outside frame of the buttonhole foot backward as far as possible, making sure that there is no gap behind the part of the foot marked "A", as shown in the illustration. If the buttonhole foot is not slid back as far as possible, the buttonhole will not be sewn at the correct size.
- Pass the thread under the presser foot.

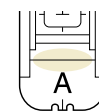

**5 Pull down the buttonhole lever.**

\* The buttonhole lever should be positioned behind the metal bracket on the buttonhole foot, as shown in the illustration.

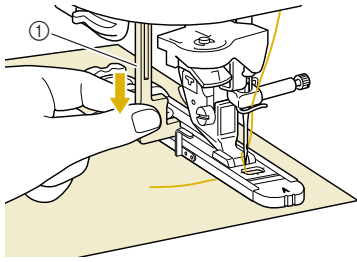

① Buttonhole lever

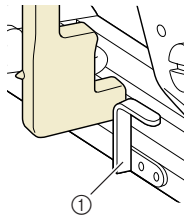

① Metal bracket

**6 Gently hold the end of the upper thread, and then start sewing.**

\* Once sewing is completed, the machine automatically sews reinforcement stitches, then stops.  
\* If the automatic thread cutting setting is selected before sewing, the machine will automatically cut the thread at the end of stitching.

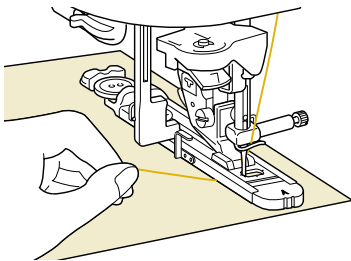

→ A buttonhole starts to sew from the front of the presser foot to the back.

**Note**

- If the fabric does not feed, for example, because it is too thick, press **+** in the length display to increase the stitch length.
- When sewing is finished, raise the buttonhole lever to its original position.

**7 Insert a pin along the inside of a bar tack at the end of the buttonhole, and then insert the seam ripper into the center of the buttonhole and cut towards the pin.****Note**

Be careful not to cut the stitches with the seam ripper.

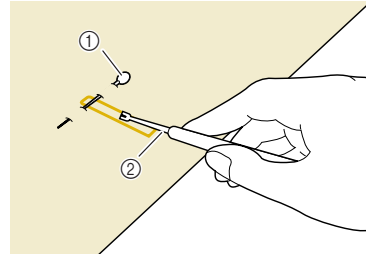

① Pin  
② Seam ripper

**CAUTION**

- When using the seam ripper to open the buttonhole, do not put your hand or finger in the path of the ripper. The ripper may slip and cause injury.

For keyhole buttonholes, use the included eyelet punch to make a hole in the rounded end of the buttonhole. Then, insert a pin along the inside of the bar tack, insert a seam ripper into the hole made with the eyelet punch, and then cut towards the pin.

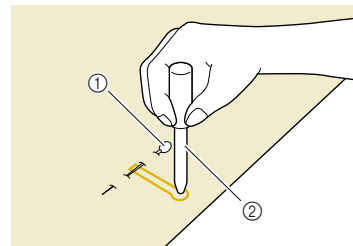

① Pin  
② Eyelet punch



3

Utility Stitches

### ■ Sewing Stretch Fabrics

When sewing a buttonhole on stretch fabrics, press

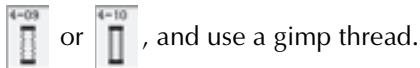

- 1 Hook the gimp thread onto the back of buttonhole foot “A”, and then pull the ends of the gimp thread under the presser foot. Pass the thread ends through the grooves at the front of the presser foot, and then temporarily tie them.**

\* Use #5 embroidery thread or lace yarn for the gimp thread.

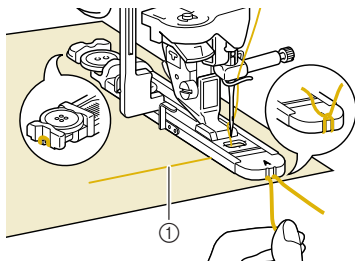

① Upper thread

- 2 Lower the presser foot lever, and then start sewing.**

\* Set the stitch width to the width of the gimp thread.

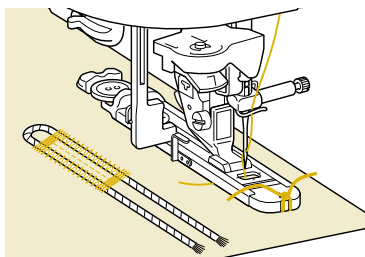

- 3 When sewing is finished, gently pull the gimp thread to remove any slack, and then use a handsewing needle with a large eye to pull the gimp thread to the wrong side of the fabric.**

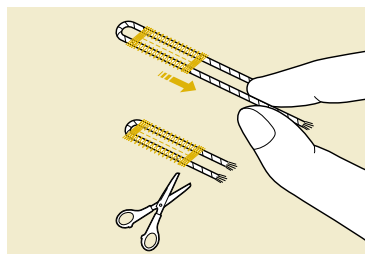

- 4 Tie the ends together, and then trim the excess.**

\* After using the seam ripper to cut the threads sewn over the buttonhole, trim the threads.

### ■ Buttons That Do Not Fit into the Button Holder Plate

Use the markings on the presser foot scale to set the size of the buttonhole. The distance between the markings on the presser foot scale is 5 mm (approx. 3/16 inch).

Add together the diameter and thickness of the button, and then set the button holder plate to the calculated value.

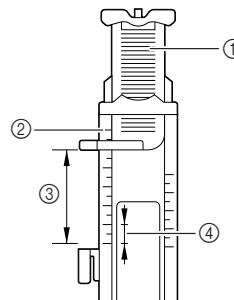

- ① Button holder plate
- ② Presser foot scale
- ③ Finished measurement (diameter + thickness)
- ④ 5 mm (approx. 3/16 inch)

**Example:** For a button with a diameter of 15 mm (approx. 9/16 inch) and a thickness of 10 mm (approx. 3/8 inch), the scale should be set at 25 mm (approx. 1 inch).

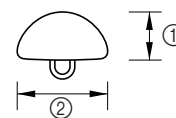

- ① Thickness: 10 mm (approx. 3/8 inch)
- ② Diameter: 15 mm (approx. 9/16 inch)

## Darning

Use darning stitches for mending and other applications.

Stitch Key	Stitch Name	Presser Foot	Applications	Stitch Width [mm (inch)]		Stitch Length [mm (inch)]		Twin Needle
				Auto.	Manual	Auto.	Manual	
	Darning		Darning of medium weight fabric	<b>7.0</b> <b>(1/4)</b>	2.5 - 7.0 (3/32 - 1/4)	<b>2.0</b> <b>(1/16)</b>	0.4 - 2.5 (1/64 - 1/16)	NO
	Darning		Darning of heavyweight fabric	<b>7.0</b> <b>(1/4)</b>	2.5 - 7.0 (3/32 - 1/4)	<b>2.0</b> <b>(1/16)</b>	0.4 - 2.5 (1/64 - 1/16)	NO

Darning is sewn from the front of the presser foot to the back, as shown below.

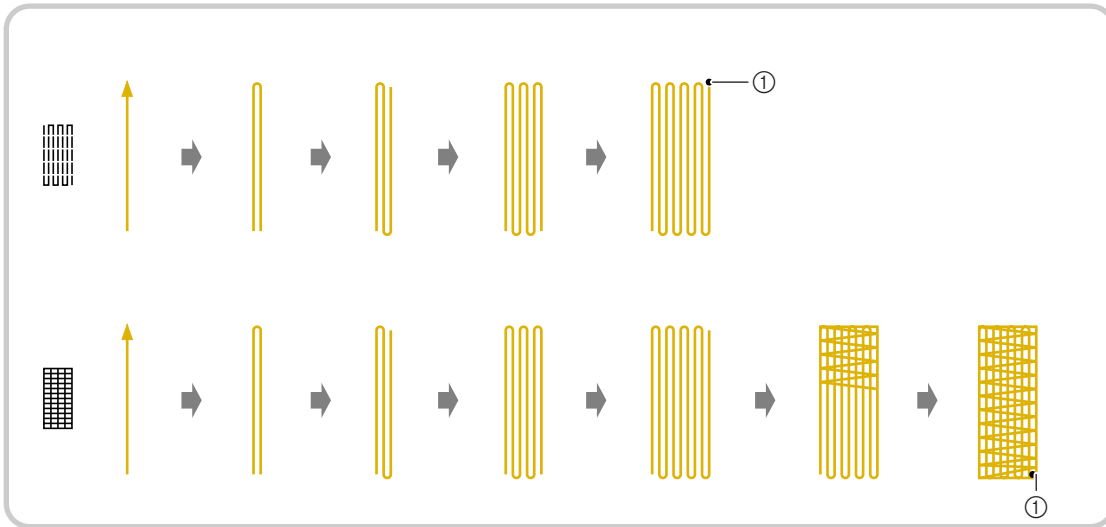

① Reinforcement stitching

- 1 Select a stitch pattern.
- 2 Set the scale on buttonhole foot "A" to the desired length of the darning, and then attach the buttonhole foot.



### Memo

The maximum length for darning is 28 mm (approx. 1-1/16 inches).

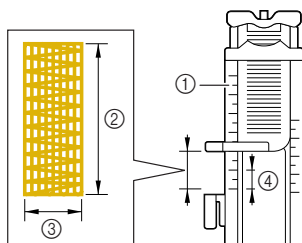

- ① Presser foot scale
- ② Finished measurement
- ③ 7 mm wide (approx. 1/4 inch)
- ④ 5 mm (approx. 3/16 inch)

- 3 Hold the outside frame of the buttonhole foot toward the back with your finger, and then lower the presser foot so that it aligns with the area to be darned.

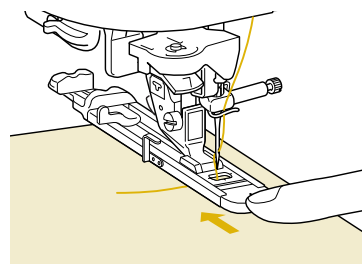

### Note

- Slide the outside frame of the buttonhole foot backward as far as possible, making sure that there is no gap behind the part of the foot marked "A", as shown in the illustration. If the buttonhole foot is not slid back as far as possible, the darning will not be sewn at the correct size.
- Pass the thread under the presser foot.

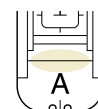

3

Utility Stitches

**4 Pull down the buttonhole lever.**

\* The buttonhole lever should be positioned behind the metal bracket on the buttonhole foot, as shown in the illustration.

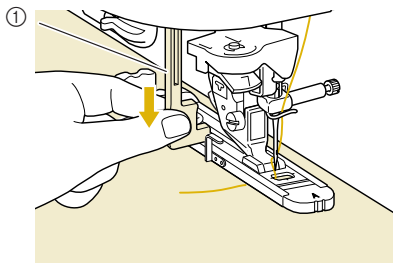

① Buttonhole lever

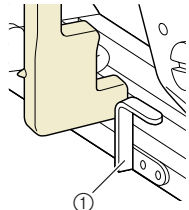

① Metal bracket

**5 Gently hold the end of the upper thread, and then start sewing.**

\* Once sewing is completed, the machine automatically sews reinforcement stitches, then stops.  
 \* If the automatic thread cutting setting is selected before sewing, the machine will automatically cut the thread at the end of stitching.

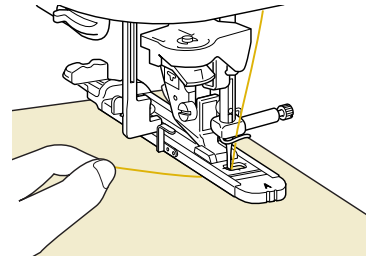

**Note**

If the fabric does not feed, for example, because it is too thick, press **+** in the length display to increase the stitch length.

**Bar Tacks**

Bar tacks are one type of reinforcement stitching used to strengthen points subject to strain, such as ends of pocket openings and slits.

Stitch Key	Stitch Name	Presser Foot	Applications	Stitch Width [mm (inch)]		Stitch Length [mm (inch)]		Twin Needle
				Auto.	Manual	Auto.	Manual	
	Bar tack		Reinforcement at opening of pocket, etc.	2.0 (1/16)	1.0 - 3.0 (1/16 - 1/8)	0.4 (1/64)	0.3 - 1.0 (1/64 - 1/16)	NO

**1** Press .

**2** Set the scale on buttonhole foot “A” to the desired length of the darning, and then attach the buttonhole foot.



**Memo**

The bar tack length can be set between 5 and 28 mm (approx. 3/16 and 1-1/16 inches). Bar tacks are usually between 5 and 10 mm (approx. 3/16 and 3/8 inch) (This differs depending on the application.)

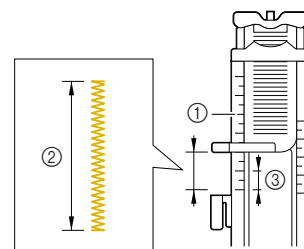

- ① Presser foot scale
- ② Finished measurement
- ③ 5 mm (approx. 3/16 inch)

- 3** Position the fabric so that the opening of the pocket moves toward you during sewing. Hold the outside frame of the buttonhole foot toward the back with your finger, check the first needle drop point, and then lower the presser foot.

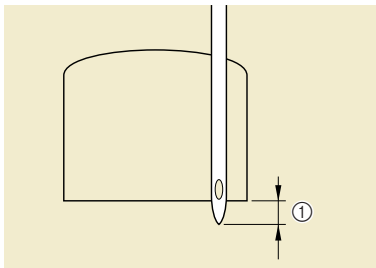
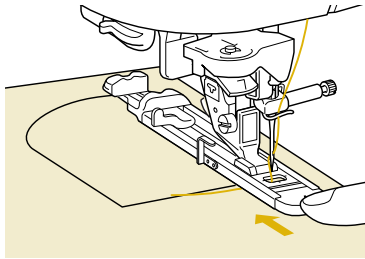

① First needle drop point: 2 mm (approx. 1/16 inch)



**Note**

- Slide the outside frame of the buttonhole foot backward as far as possible, making sure that there is no gap behind the part of the foot marked "A", as shown in the illustration. If the buttonhole foot is not slid back as far as possible, the bar tack will not be sewn at the correct size.
- Pass the thread under the presser foot.

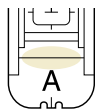

- 4** Pull down the buttonhole lever.

- \* The buttonhole lever should be positioned behind the metal bracket on the buttonhole foot, as shown in the illustration.

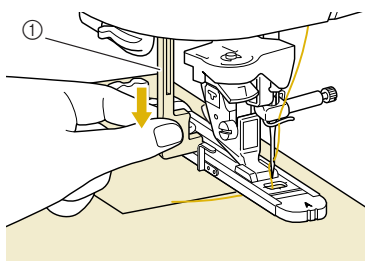

① Buttonhole lever

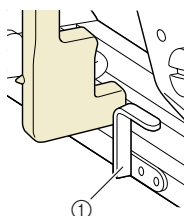

① Metal bracket

- 5** Gently hold the end of the upper thread, and then start sewing.

- \* Once sewing is completed, the machine automatically sews reinforcement stitches, then stops.
- \* If the automatic thread cutting setting is selected before sewing, the machine will automatically cut the thread at the end of stitching.

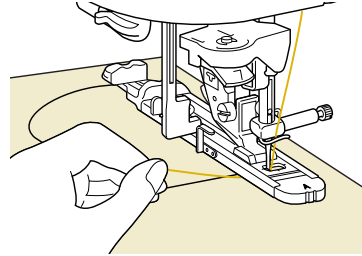

■ **Bar Tacks on Thick Fabrics**

Place a piece of folded fabric or cardboard beside the fabric being sewn to level the buttonhole foot and allow for easier feeding.

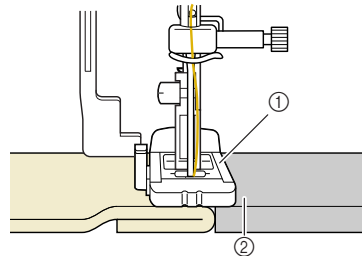

① Presser foot  
② Thick fabric



**Note**

If the fabric does not feed, for example, because it is too thick, press **+** in the length display to increase the stitch length.



3

Utility Stitches



## Button Sewing

Buttons with 2 or 4 holes can be sewn on.



### Note

Make sure that the automatic thread cutting setting is not selected when sewing on buttons.

Stitch Key	Stitch Name	Presser Foot	Applications	Stitch width [mm (inch.)]		Stitch length [mm (inch.)]		Twin needle
				Auto.	Manual	Auto.	Manual	
	Button sewing		Attaching buttons	3.5 (1/8)	2.5 - 4.5 (3/32 - 3/16)	—	—	NO

1 Press  .

2 Raise the presser foot lever, and remove the flat bed attachment.

3 Lower the feed dog position switch to  to lower the feed dogs.

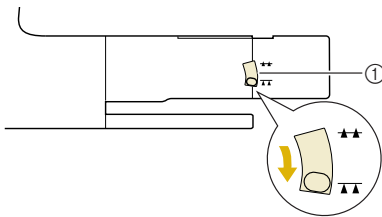

① Feed dog position switch (as seen from the rear of the machine)

4 Attach button fitting foot “M”, slide the button along the metal plate and into the presser foot, and then lower the presser foot lever.

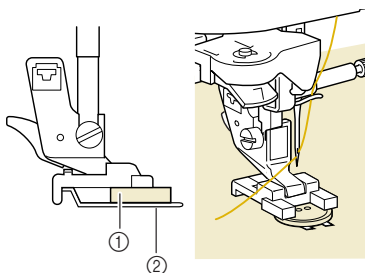

① Button  
② Metal plate

5 Turn the handwheel toward you to check that the needle correctly goes into the holes of the button without touching it.

### CAUTION

- Make sure the needle does not strike the button during sewing. The needle may break and cause injury.

6 Gently hold the end of the upper thread, and then start sewing.

- \* Once sewing is completed, the machine automatically sews reinforcement stitches, then stops.
- \* If the automatic thread cutting setting is selected before sewing, the machine will automatically cut the thread at the end of stitching.



### Note

- To attach the button more securely, repeat the procedure.
- Adjust the stitch width to the distance between the holes in the button.

7 With scissors, cut the upper and bobbin threads at the beginning of the stitching, pull the upper thread at the end of the stitching to the wrong side of the fabric, and then tie it with the bobbin thread.

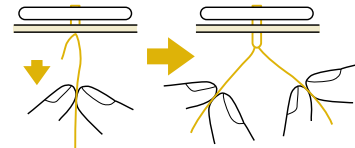

8 When button sewing is finished, raise the feed dog position switch to  to raise the feed dogs.

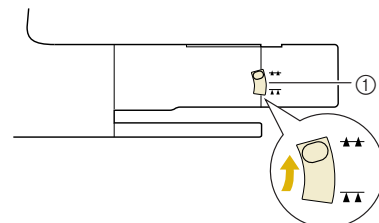

① Feed dog position switch (as seen from the rear of the machine)



### ■ Attaching a 4-Hole Button

Sew the two holes toward the front. Then, raise the presser foot, move the fabric so that the needle goes into the back two holes, and then sew them in the same way.

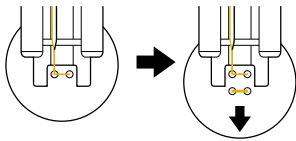

### ■ Attaching a Button with a Shank

1 Pull the shank lever toward you.

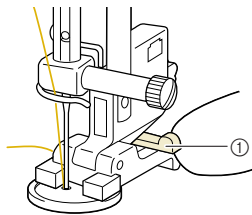

① Shank lever

2 When sewing is finished, pull the two ends of the upper thread between the button and the fabric, wind them around the shank, and then tie them together.

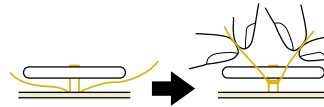

3 Tie the ends of the bobbin thread together at the beginning and end of the stitching on the wrong side of the fabric



Utility Stitches

## Eyelets

Eyelets can be used for making belt holes and other similar applications.

Stitch Key	Stitch Name	Presser Foot	Applications	Stitch width [mm (inch.)]		Stitch length [mm (inch.)]		Twin needle
				Auto.	Manual	Auto.	Manual	
	Eyelet		For making eyelets, holes on belts, etc.	7.0 (1/4)	7.0 6.0 5.0 (1/4 15/64 3/16)	7.0 (1/4)	7.0 6.0 5.0 (1/4 15/64 3/16)	NO

1 Press , and then attach presser foot “N”.

2 Press or in the width display or or in the length display to set the size of the eyelet.



3 Lower the needle into the fabric at the beginning of the stitching, lower the presser foot lever, and then start sewing.

\* Reinforcement stitches are automatically sewn at the end of the stitching.

\* If the automatic thread cutting setting is selected before sewing, the machine will automatically cut the thread at the end of stitching.

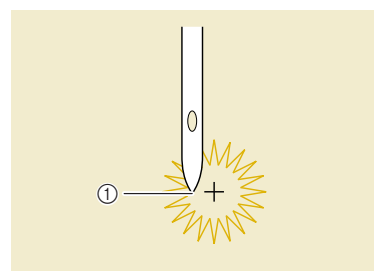

① Starting point of stitching

- 4 Use the eyelet punch to cut a hole in the center of the stitching.

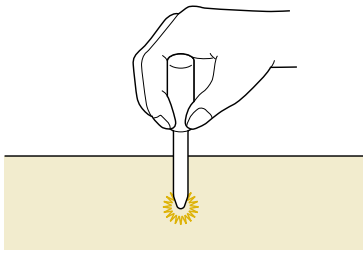

## Multi-Directional Sewing (Straight Stitch and Zigzag Stitch)

Use these stitch patterns to attach patches or emblems to pant legs, shirt sleeves, etc.

### Memo

Pass the free arm through the tubular piece of fabric, and then sew in the order shown in the illustration.

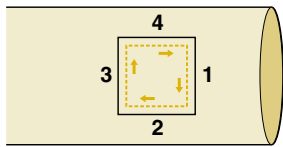

- 1 Remove the flat bed attachment to enable free-arm sewing.

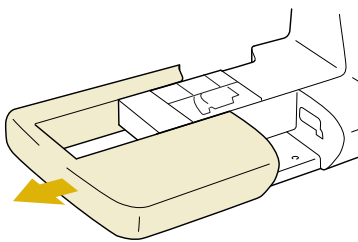

- 2 Pass the free arm through the fabric.
- 3 Press , and then attach presser foot "N".

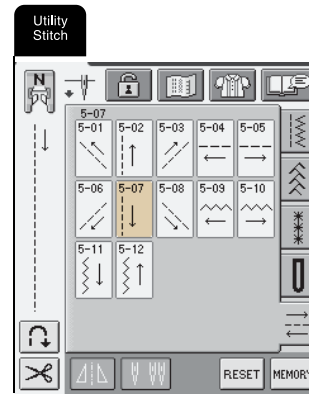

### Memo

For details on the stitch patterns, refer to the "STITCH SETTING CHART" at the end of this manual.

- 4 Insert the needle into the fabric at the starting point of the stitching, and then sew seam 1.

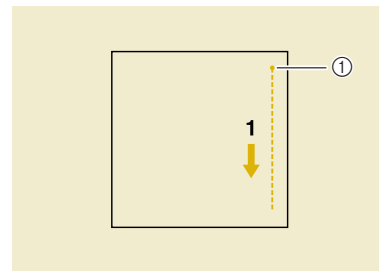

① Starting point of stitching

- 5 Press , and then sew seam 2.

\* The fabric will move sideways, so guide the fabric with your hands to sew straight.

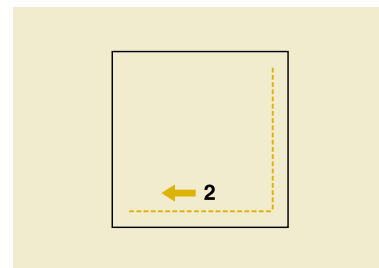

- 6 Press , and then sew seam 3.

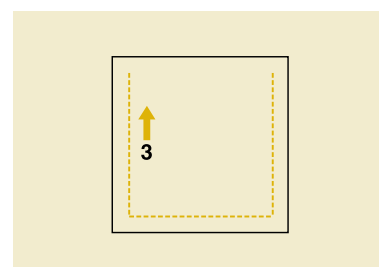

**7** Press , and then sew seam 4.

\* The fabric will move sideways, so guide the fabric with your hands to sew straight.

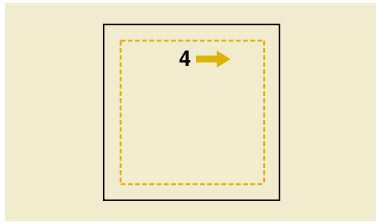

**Memo**

Zigzag stitches can also be used with multi-directional sewing.

## Zipper Insertion

### Centered Zipper

Use for bags and other such applications.

**1** Press .

\* Be sure to select the straight stitch with the middle needle position.

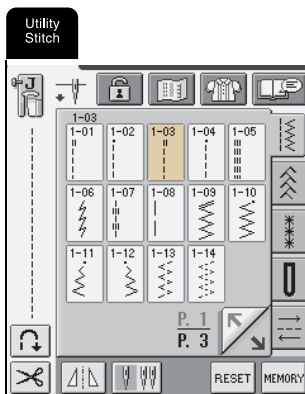

**Memo**

For details on the stitch patterns, refer to the "STITCH SETTING CHART" at the end of this manual.

**2** Attach presser foot "J", sew straight stitches up to the zipper opening, and then sew basting stitches to the top of the fabric.

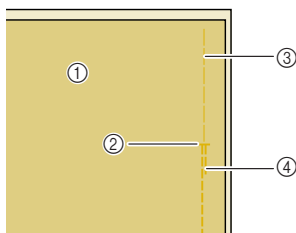

- ① Wrong side of fabric
- ② End of zipper opening
- ③ Basting
- ④ Reverse stitching

**3** Press open the seam allowance, align the seam with the center of the zipper, and then baste the zipper in place.

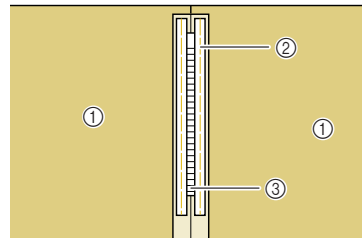

- ① Wrong side of fabric
- ② Basting
- ③ Zipper teeth

**4** Remove presser foot "J", and then attach the pin on the right side of zipper foot "I" to the presser foot holder.

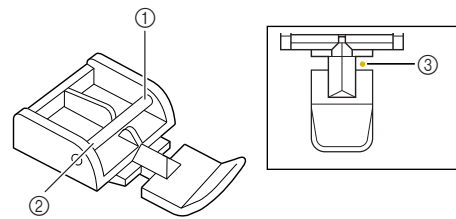

- ① Right side
- ② Left side
- ③ Needle drop point

### CAUTION

- When using zipper foot "I", make sure the straight stitch, middle needle position is selected. Turn the handwheel to make sure the needle does not strike the presser foot. If another stitch is selected, the needle will strike the presser foot, causing the needle to break and possibly causing injury.

**5** Topstitch around the zipper, and then remove the basting.

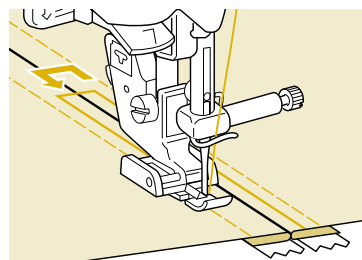

### CAUTION

- Make sure the needle does not strike the zipper during sewing. If the needle strikes the zipper, the needle may break, leading to injury.



3

Utility Stitches

## Side Zipper

Use for side zippers on skirts or dresses.

### 1 Press

\* Be sure to select the straight stitch with the middle needle position.

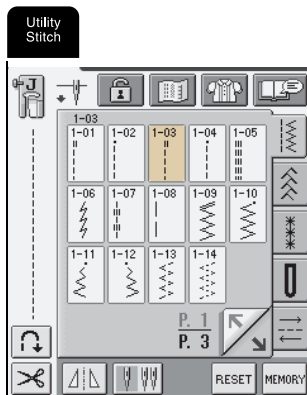

### 2 Attach presser foot "J", sew straight stitches to the zipper opening, and then sew basting stitches to the edge of the fabric.

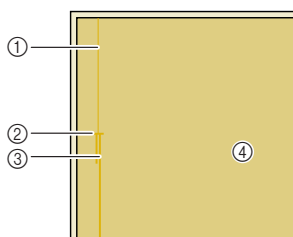

- ① Basting
- ② End of zipper opening
- ③ Reverse stitching
- ④ Wrong side of fabric

### 3 Press the seam allowance open and align the folded hem along the teeth of the zipper, while maintaining 3 mm (approx. 1/8 inch) of sewing space.

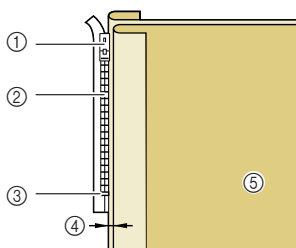

- ① Zipper pull tab
- ② Zipper teeth
- ③ End of zipper opening
- ④ 3 mm (approx. 1/8 inch)
- ⑤ Wrong side of fabric

### 4 Remove presser foot "J", and then attach the presser foot holder to the pin on the right side of zipper foot "I".

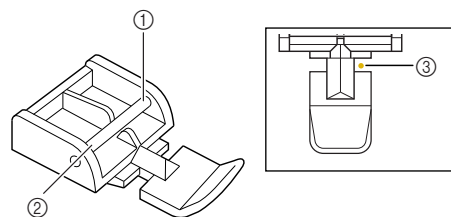

- ① Right side
- ② Left side
- ③ Needle drop point

## CAUTION

- When using zipper foot "I", make sure the straight stitch, middle needle position is selected. Turn the handwheel to make sure the needle does not strike the presser foot. If another stitch is selected, the needle will strike the presser foot, causing the needle to break and possibly causing injury.

### 5 Set the presser foot in the 3 mm (approx. 1/8 inch) margin.

### 6 Starting from the end of the zipper opening, sew to a point about 50 mm (approx. 2 inches) from the edge of the fabric, then stop the machine.

### 7 Pull down the zipper slider, then continue sewing to the edge of the fabric.

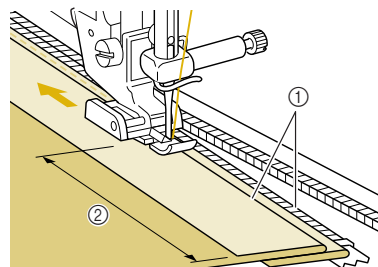

- ① 3 mm (approx. 1/8 inch)
- ② 50 mm (approx. 2 inch)

## CAUTION

- Make sure the needle does not strike the zipper during sewing. If the needle strikes the zipper, the needle may break, leading to injury.

- 8** Close the zipper, turn the fabric over so that the surface faces up, and then baste the other side of the zipper to the fabric.

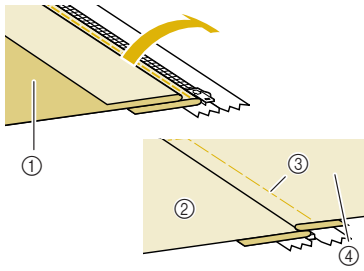

- ① Front of garment (wrong side of fabric)
- ② Back of garment (surface of fabric)
- ③ Basting
- ④ Front of garment (surface of fabric)

- 9** Remove the presser foot, and then attach the pin on the left side of the zipper foot to the presser foot holder.

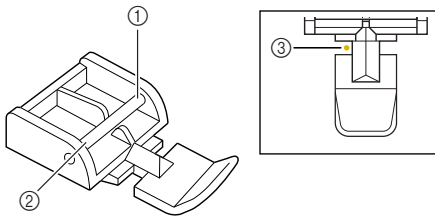

- ① Right side
- ② Left side
- ③ Needle drop point

- 10** Set the fabric so that the left edge of the presser foot touches the edge of the zipper teeth.

- 11** Sew reverse stitches at the top of the zipper, then continue sewing.

- 12** Stop sewing about 50 mm (approx. 2 inches) from the edge of the fabric, leave the needle in the fabric, and remove the basting stitches.

- 13** Open the zipper and sew the rest of the seam.

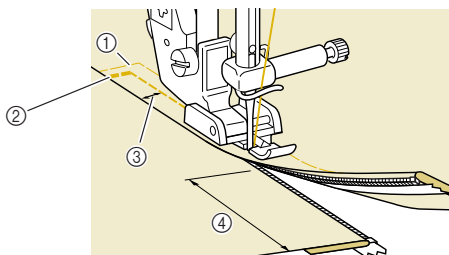

- ① Basting
- ② Reverse stitching
- ③ 7 to 10 mm (approx. 1/4 to 3/8 inch)
- ④ 50 mm (approx. 2 inches)



3

Utility Stitches





# Chapter 4

## Character/ Decorative Stitches

<b>SELECTING STITCH PATTERNS.....</b>	<b>94</b>
■ <b>Stitch Selection Screens.....</b>	<b>94</b>
<b>Selecting Decorative Stitch Patterns/7 mm Decorative Stitch Patterns/Satin Stitch Patterns/     7 mm Satin Stitch Patterns/Cross Stitch Patterns/Utility Decorative Stitch Patterns.....</b>	<b>95</b>
<b>Alphabet Patterns.....</b>	<b>95</b>
<b>SEWING STITCH PATTERNS .....</b>	<b>97</b>
<b>Sewing Attractive Finishes.....</b>	<b>97</b>
<b>Basic Sewing .....</b>	<b>97</b>
<b>Adjusting Patterns .....</b>	<b>98</b>
<b>EDITING STITCH PATTERNS.....</b>	<b>100</b>
■ <b>Key Functions .....</b>	<b>100</b>
<b>Changing the Pattern Size .....</b>	<b>101</b>
<b>Changing the Pattern Length (7 mm Satin Stitch Patterns Only) .....</b>	<b>101</b>
<b>Creating a Vertical Mirror Image .....</b>	<b>101</b>
<b>Creating a Horizontal Mirror Image.....</b>	<b>101</b>
<b>Selecting a Single/Repeating Pattern .....</b>	<b>102</b>
<b>Changing the Thread Density (Satin Stitch Patterns Only) .....</b>	<b>102</b>
<b>Checking the Image.....</b>	<b>103</b>
<b>COMBINING STITCH PATTERNS.....</b>	<b>104</b>
<b>Before Combining Patterns .....</b>	<b>104</b>
<b>Combining Patterns From Different Categories.....</b>	<b>104</b>
<b>Combining Stitch Patterns of Different Sizes.....</b>	<b>106</b>
<b>Combining Stitch Patterns of Different Orientations.....</b>	<b>106</b>
<b>Combining Stitch Patterns of Different Lengths .....</b>	<b>107</b>
<b>Creating Step Patterns (7 mm Satin Stitch Patterns Only) .....</b>	<b>108</b>
■ <b>Examples of Pattern Combinations .....</b>	<b>109</b>
<b>USING THE MEMORY FUNCTION .....</b>	<b>110</b>
<b>Stitch Data Precautions.....</b>	<b>110</b>
■ <b>Types of Stitch Data that can be Used .....</b>	<b>110</b>
■ <b>Types of USB Devices/Media that can be Used .....</b>	<b>110</b>
■ <b>Computers and Operating Systems with the Following Specifications can be Used .....</b>	<b>110</b>
■ <b>Precautions on Using the Computer to Create and Save Data .....</b>	<b>111</b>
■ <b>Trademarks.....</b>	<b>111</b>
<b>Saving Stitch Patterns in the Machine's Memory.....</b>	<b>112</b>
■ <b>If the Memory Is Full .....</b>	<b>112</b>
<b>Saving Stitch Patterns to USB Media (Commercially Available) .....</b>	<b>113</b>
<b>Saving Stitch Patterns to the Computer .....</b>	<b>114</b>
<b>Retrieving Stitch Patterns from the Machine's Memory .....</b>	<b>115</b>
<b>Retrieving stitch pattern from USB Media.....</b>	<b>116</b>
<b>Retrieving Stitch Patterns from the Computer.....</b>	<b>117</b>

# SELECTING STITCH PATTERNS

## Stitch Selection Screens

Press  to display the screen shown below.

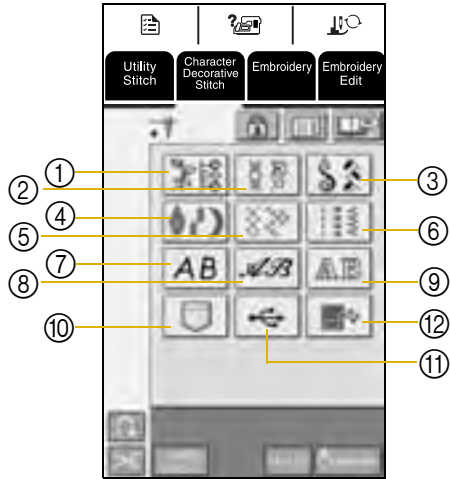

- ① Decorative stitch patterns
- ② 7 mm decorative stitch patterns
- ③ Satin stitch patterns
- ④ 7 mm satin stitch patterns
- ⑤ Cross stitch patterns
- ⑥ Utility decorative stitch patterns
- ⑦ Alphabet patterns (gothic font)
- ⑧ Alphabet patterns (handwriting font)
- ⑨ Alphabet patterns (outline style)
- ⑩ Patterns saved in the machine's memory (see page 115)
- ⑪ Patterns saved in USB media (see page 116)
- ⑫ Patterns saved on the computer (see page 117)

Press  to display the previous or next page.

\* The patterns in screens ②, ④ and ⑥ have a stitch width of 7 mm or less. Both the stitch length and width can be adjusted.

- ① Decorative stitch patterns
- ② 7 mm decorative stitch patterns
- ③ Satin stitch patterns
- ④ 7 mm satin stitch patterns
- ⑤ Cross stitch patterns

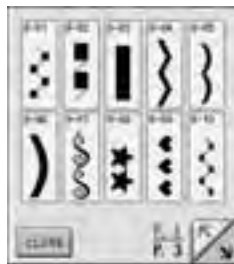
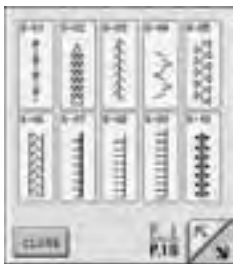

- ⑥ Utility decorative stitch patterns
- ⑦ Alphabet patterns (gothic font)
- ⑧ Alphabet patterns (handwriting font)
- ⑨ Alphabet patterns (outline style)

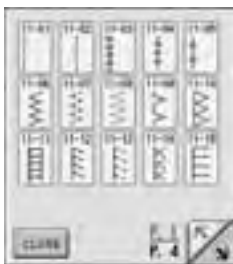

**Note**

When the screen is locked (  ), no key other than  and the     keys can be operated.



## Selecting Decorative Stitch Patterns/ 7 mm Decorative Stitch Patterns/ Satin Stitch Patterns/ 7 mm Satin Stitch Patterns/Cross Stitch Patterns/Utility Decorative Stitch Patterns

- 1 Press **Character Decorative Stitch**, and then press the key for the category containing the pattern that you want to sew.

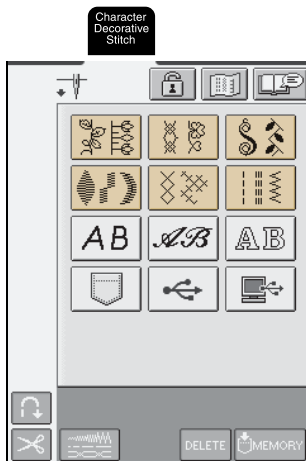

- 2 Select a stitch pattern that you want to sew.

- \* Press to display the next page.
- \* Press to display the previous page.
- \* Press **CLOSE** to return to the screen of pattern categories.

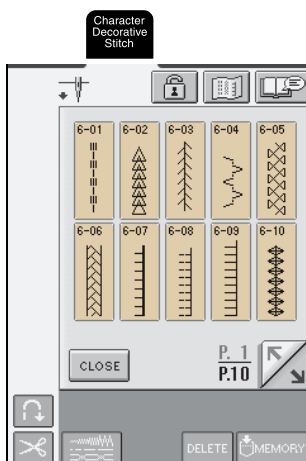

→ An image of the selected stitch pattern is displayed below the symbol of the appropriate presser foot.

- 3 To combine patterns, select the next pattern.

- \* Press to check the selected pattern combination.
- \* If the wrong pattern was selected, press **DELETE** to erase the pattern, and then select the new stitch pattern.



## Alphabet Patterns

Three alphabet patterns are available in different styles. The procedure for selecting a character is the same with all styles.

- 1 Press **Character Decorative Stitch**, and then press the key for the character style that you want to sew.

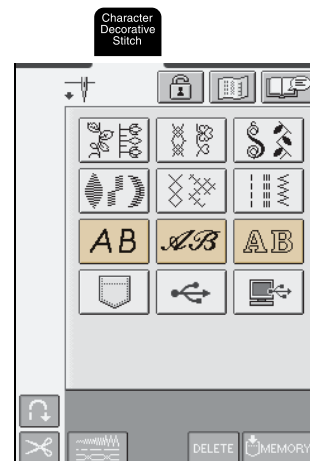

4

Character/Decorative Stitches

**2** Press **ABC abc 0-9 ?!** to display a selection screen of characters, and then select a character. Repeat this step until you have selected all of the characters.

- \* If a wrong character was selected, press **DELETE** to erase the character, and then select the new character.
- \* To select a different character style, press **CLOSE**, and then select the new character style.
- \* Press **☰** to check the selected characters.

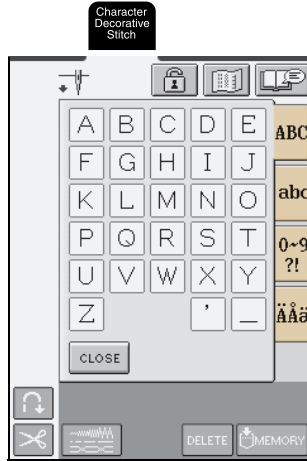

→ An image of the selected characters is displayed below the symbol of the appropriate presser foot.

**Example:** To select “Bus”

**1** Press **AB**.

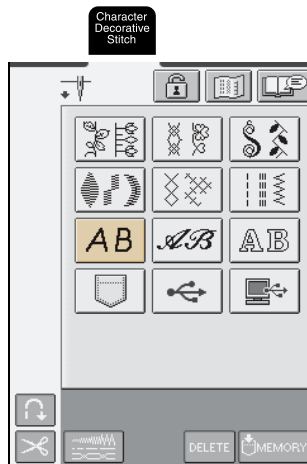

**2** Press **B**.

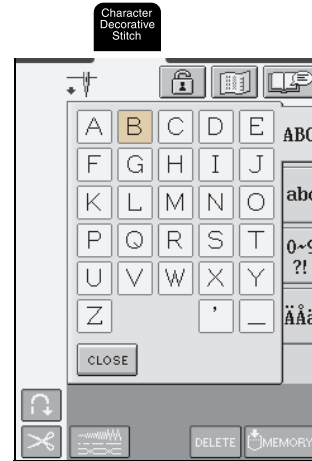

**3** Press **abc**.

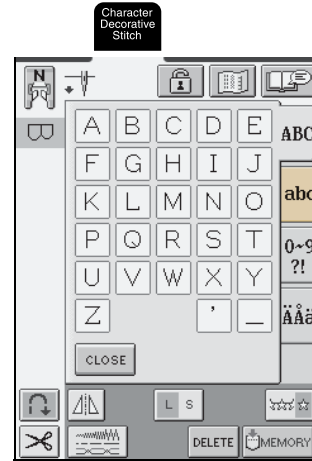

**4** Press **u**, then **s**.

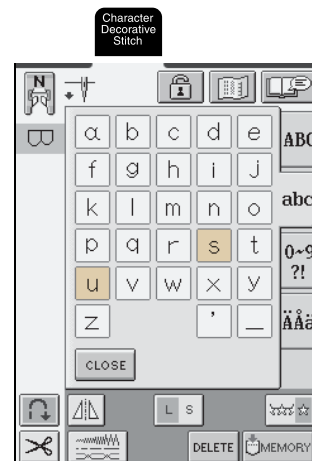

→ “Bus” appears.

- \* A maximum of 70 characters can be combined.

# SEWING STITCH PATTERNS

## Sewing Attractive Finishes



### Note

- To achieve the best results when sewing character/decorative stitches, check the table below for the proper fabric/needle/thread combinations.
- Other factors, such as the type or thickness of the fabric being sewn or the type of stabilizer material used, also affect the stitching. Therefore, be sure to sew a few trial stitches before sewing your project.
- Since shrinkage or bunched stitches may result when satin stitches are sewn, be sure to affix stabilizer material to the fabric.
- While sewing, guide the fabric with your hands so that it will be fed straight.

Fabric	When sewing on stretch fabrics, lightweight fabrics, or fabrics with coarse weaves, attach stabilizer on the wrong side of the fabric. If you do not wish to do so, place the fabric on a thin paper such as tracing paper.
	<ul style="list-style-type: none"> <li>① Fabric</li> <li>② Stabilizer</li> <li>③ Thin paper</li> </ul>
Thread	#50 - #60
Needle	With lightweight, regular, or stretch fabrics: the Ball point needle (golden colored) With heavyweight fabrics: home sewing machine needle 90/14
Presser foot	Monogramming foot "N". Using another presser foot may give inferior results.

## Basic Sewing

- 1 Select a stitch pattern.
- 2 Attach presser foot "N".
- 3 Place the fabric under the presser foot, pull the upper thread under the presser foot and to the side, and then lower the presser foot lever.

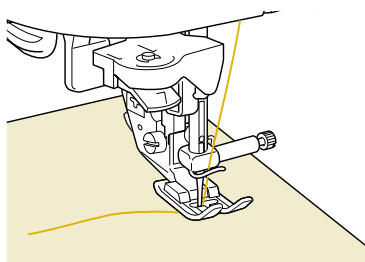

- 4 Press the "Reverse/Reinforcement Stitch" button to sew reinforcement stitches, and then press the "Start/Stop" button to start sewing.

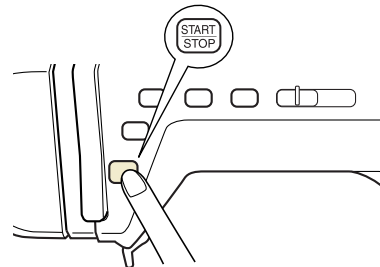

### CAUTION

- When sewing 7 mm satin stitch patterns and the stitches are bunched, lengthen the stitch length. If you continue sewing when the stitches are bunched, the needle may bend or break (see "Adjusting the Stitch Length" on page 44).



### Memo

If the fabric is pulled or pushed during sewing, the pattern may not be sewn correctly. In addition, depending on the pattern, there may be movement to the left and right as well as to the front and back. Therefore, guide the fabric with your hands so that it will be fed straight.



4

Character/Decorative Stitches

- 5 Press the “Start/Stop” button to stop the machine, and then press the “Reverse/Reinforcement Stitch” button to sew reinforcement stitches.

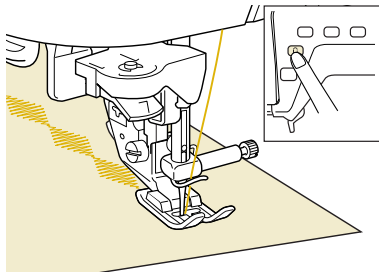

**Memo**

- When sewing character stitch patterns, the machine automatically sews reinforcement stitches at the end of the stitching, then stops (The machine is automatically set to sew reinforcement stitches at the beginning and end of each character.)

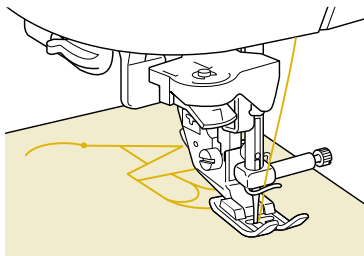



- After sewing is finished, trim any excess thread.





**Note**

When sewing some patterns, the needle will stop in the raised position while the fabric is fed due to the operation of the needle bar separation mechanism which is used in this machine. At such times, a clicking sound different from the sound generated during sewing will be heard. This sound is normal and is not the sign of a malfunction.

**Adjusting Patterns**

Depending on the type and thickness of the fabric being sewn, the sewing speed, whether or not stabilizer material is used, etc., the desired result may not be achieved. If this occurs, press , and then perform the following adjustment using the same sewing conditions as those used for your project. If the pattern is still misaligned after making adjustments with  selected, adjust each pattern separately.

- 1 Press , and then press  on P. 7 of the screen.

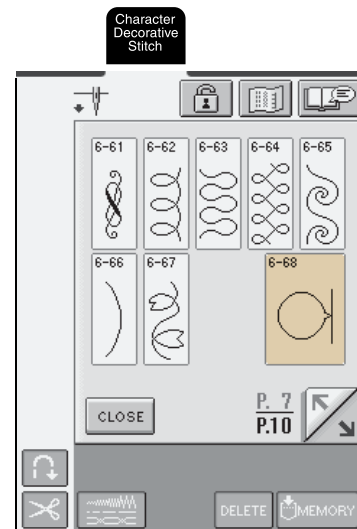

- 2 Attach presser foot “N”, and then sew the pattern.

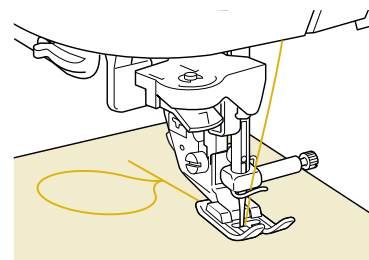

- 3 Compare the sewn pattern with the following illustration.



#### 4 Press .

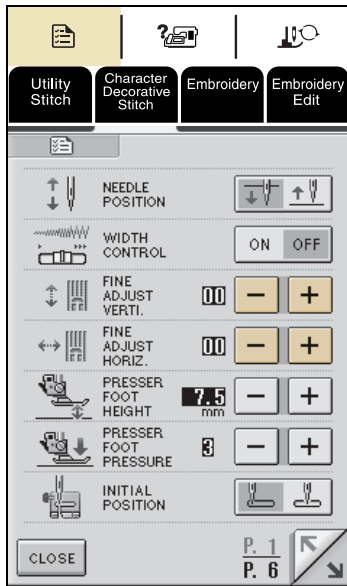

If the pattern is bunched together:

Press  in the FINE ADJUST VERTI. display. Each press of the key increases the value and lengthens the pattern.



If the pattern is stretched:

Press  in the FINE ADJUST VERTI. display. Each press of the key decreases the value and shortens the pattern.



If the pattern is skewed to the left:

Press  in the FINE ADJUST HORIZ. display. Each press of the key increases the value and moves the pattern to the right.

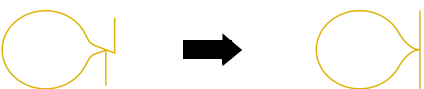

If the pattern is skewed to the right:

Press  in the FINE ADJUST HORIZ. display. Each press of the key decreases the value and moves the pattern to the left.

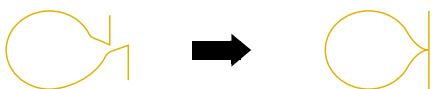

#### 5 Sew the pattern again. If the pattern still is not sewn correctly, adjust it again. Continue making adjustments until the pattern is sewn correctly.



#### Memo

You can sew with the setting screen on the display.

#### 6 After the pattern is sewn correctly, quit making adjustments. Press to return to the previous screen.



#### Note

The adjustment made will remain until changed again.



4

Character/Decorative Stitches

# EDITING STITCH PATTERNS

Using the editing functions, you can change the patterns in a variety of ways, such as resizing them or flipping them to create a mirror image.



### Memo

Depending on the pattern that is selected, some editing functions may not be available.

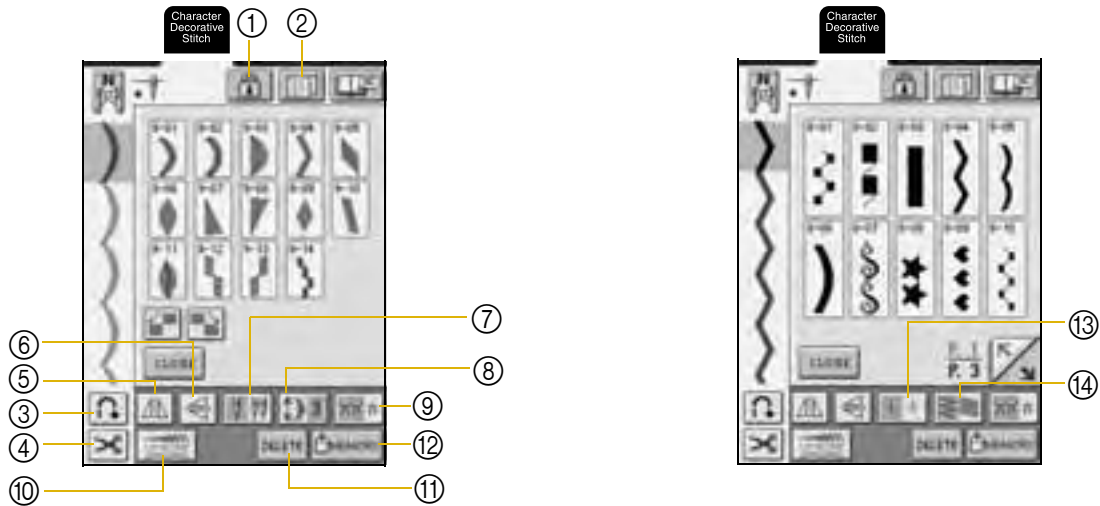

### Key Functions

No.	Key	Name	Function	Page
①		Screen lock key	Press this key to lock the screen. When the screen is locked, the various settings, such as the stitch width and stitch length, are locked and cannot be changed. Press this key again to unlock the settings.	47
②		Image key	Press this key to check an image of the selected patterns (characters). (Depending on the circumstances, this key may not be available.)	95, 96
③		Automatic reinforcement stitch key	Press this key to select the automatic reinforcement stitching setting. If you select this setting before sewing, the machine will automatically sew reinforcement stitches at the beginning and end of stitching. Press this key again to cancel the setting.	46
④		Automatic thread cutting key	Press this key to select the automatic thread cutting setting. If you select this setting before sewing, the machine will automatically cut the thread at the end of stitching. Press this key again to cancel the setting.	46
⑤		Horizontal mirror image key	Press this key to create a horizontal mirror image of the selected stitch pattern.	101
⑥		Vertical mirror image key	Press this key to create a vertical mirror image of the selected stitch pattern.	101
⑦		Needle mode selection key (single/twin)	Press this key to select the setting for twin needle sewing. Each time this key is pressed, the setting switches between that for single needle sewing and for twin needle sewing.	32
⑧		Elongation key	If a 7 mm satin stitch pattern is selected, press this key to select from five settings for changing the pattern length without changing the zigzag width or stitch length.	101
⑨		Single/repeat sewing key	Press this key to switch between sewing the pattern a single time or repeatedly.	102
⑩		Stitch settings key	Press this key to change the stitch width, stitch length and thread tension for the selected pattern. Normally, the machine has default settings.	44
⑪		Delete key	If the wrong pattern was accidentally selected, press this key to erase it. If patterns have been combined, each press of this key erases the last pattern in the combination.	95, 96
⑫		Memory key	Press this key to save the pattern combination.	112
⑬		Size key	Press this key after selecting a pattern to change the size of the pattern (large or small).	101
⑭		Thread density key	Press this key after selecting a pattern to change the stitching density of the pattern.	102

## Changing the Pattern Size

After selecting a stitch pattern, press  until the desired size is selected.



### Memo

- Stitch patterns entered after the pattern size was changed are added at the selected size until it is changed again.
- You cannot change the size of stitch patterns once they have been combined.

Actual size

L



S



## Changing the Pattern Length (7 mm Satin Stitch Patterns Only)

If 7 mm satin stitch patterns are selected, the pattern length can be changed without changing the zigzag width or stitch length. After selecting a stitch pattern, press  to select one of the five settings available.

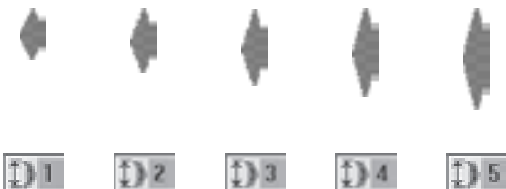

## Creating a Vertical Mirror Image

After selecting a stitch pattern, press  to flip the pattern vertically.



## Creating a Horizontal Mirror Image

After selecting a stitch pattern, press  to flip the pattern horizontally.



4



Character/Decorative Stitches

## Selecting a Single/Repeating Pattern

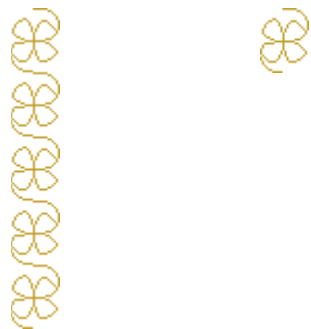
Press  to select whether the pattern is sewn repeatedly or once.



### Memo



If you press  while sewing, the key changes to  and the machine will sew one copy of the pattern, then automatically stop.

## Changing the Thread Density (Satin Stitch Patterns Only)

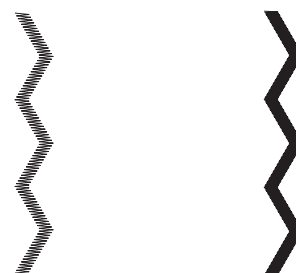
After selecting a stitch pattern, press  until the desired stitching density is selected.



### CAUTION

- If the stitches bunch when thread density is changed to , return the thread density to . If you continue sewing when the stitches are bunched, the needle may bend or break.

### Memo

- Stitch patterns entered after the stitching density was changed are added at the selected density until it is changed again.
- You cannot change the stitching density of stitch patterns once they have been combined.



## Checking the Image

You can display an image that is an approximate size of the selected stitch pattern. You can also check and change the colors of the image on the screen.

1 Press .

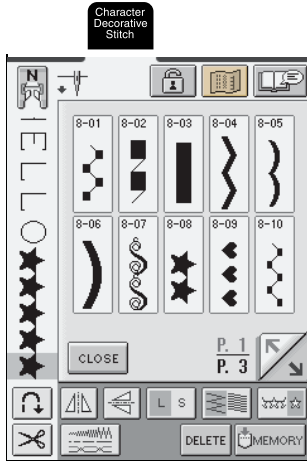



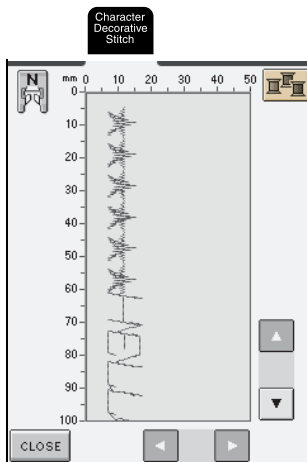

→ An image of the selected pattern is displayed.

2 Press  to change the thread color in the image.



→ The color changes every time you press the button.

3 Use     to view any part of the image that extends out of the viewable display area.

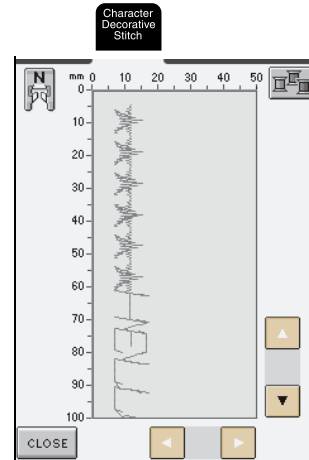

4 Press  to return to the original screen.

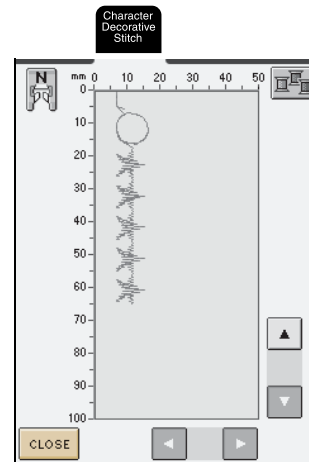

### Memo

You can also sew from this screen when the presser foot symbol is displayed.



4

Character/Decorative Stitches

# COMBINING STITCH PATTERNS

Stitch patterns, such as character stitches, satin stitches, cross stitches and decorative stitches, can be combined in a wide variety of ways. In addition, you can create interesting variations by combining stitch patterns of different categories, sizes, and orientations.

## Before Combining Patterns

 **Note**

- When stitch patterns are combined, the machine is automatically set to sew the pattern once. To repeatedly sew the combined stitch patterns, combine the patterns, and then press .
- You cannot change settings (such as the size and orientation) for stitch patterns once they have been combined. To resize or reorient the patterns, specify the settings for each pattern as it is added to the combination.

## Combining Patterns From Different Categories

Example:



1 Press .



2 Press .

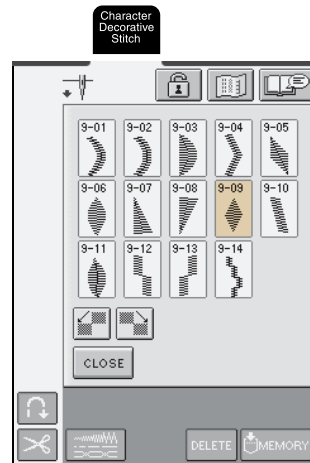

3 Press .

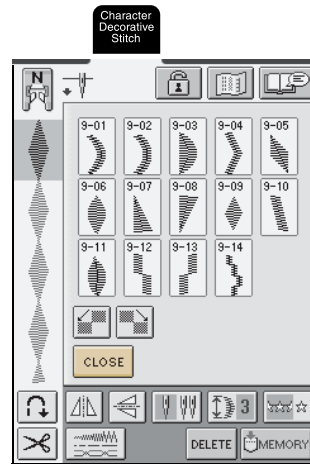



→ The screen of pattern categories appears.

4 Press .

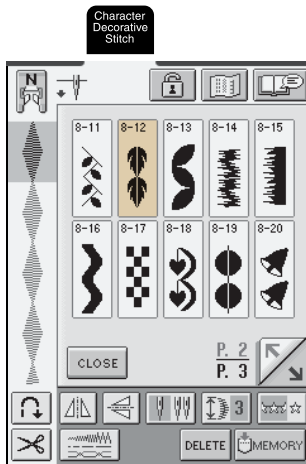

5 Press .



6 To repeatedly sew the pattern combination, press  so that it appears as .

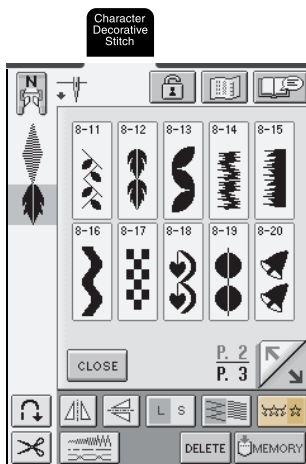

### Memo

- Press **DELETE** to erase the last pattern entered. Patterns are erased one at a time.
- If the entire combined pattern cannot be displayed, press  to view an image of the pattern. Press **CLOSE** to return to the previous screen.

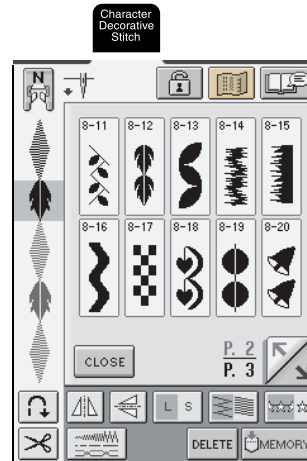

→ The image of the pattern appears.

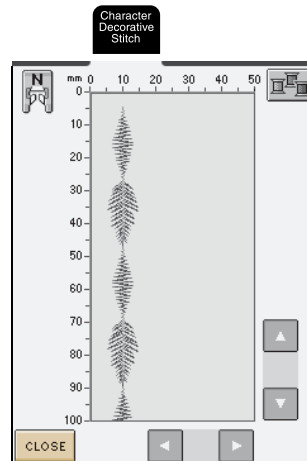

4

Character/Decorative Stitches

## Combining Stitch Patterns of Different Sizes

Example:



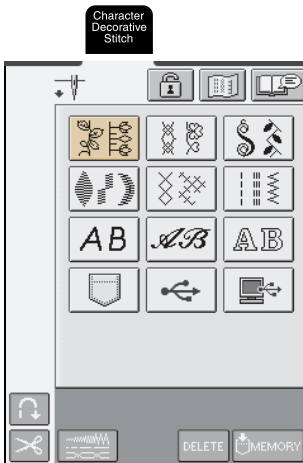

1 Press .

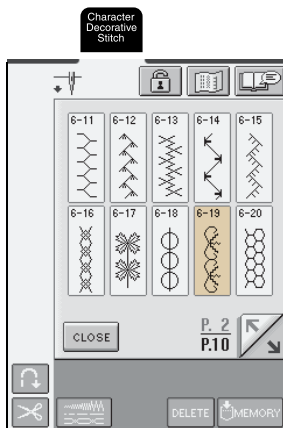

2 Press .



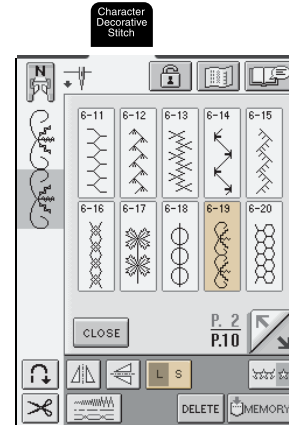

→ The larger size pattern appears.

3 Press  again, and then press  so that it appears as .



→ The second pattern is displayed in the smaller size.

4 To repeatedly sew the pattern combination, press  so that it appears as .

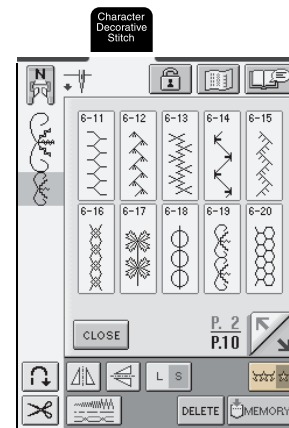

→ The combination appears as a repeating pattern.

## Combining Stitch Patterns of Different Orientations

Example:





1 Press .



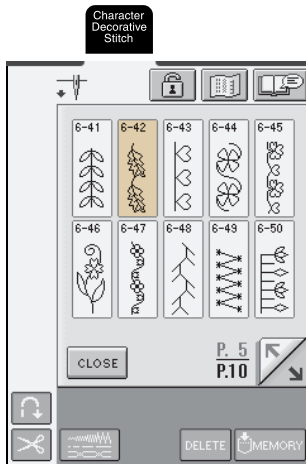

2 Press .



3 Press  again, and then press  so that it appears as .



→ The second pattern is flipped horizontally.

4 To repeatedly sew the pattern combination, press  so that it appears as .

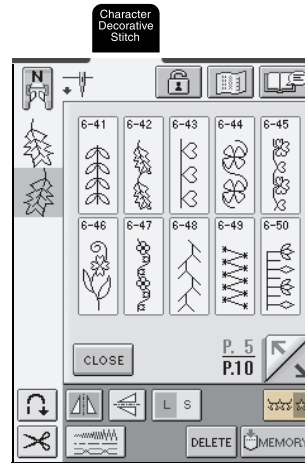

→ The combination appears as a repeating pattern.

## Combining Stitch Patterns of Different Lengths







4

Character/Decorative Stitches

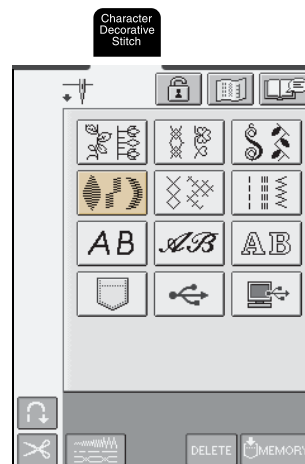



1 Press .

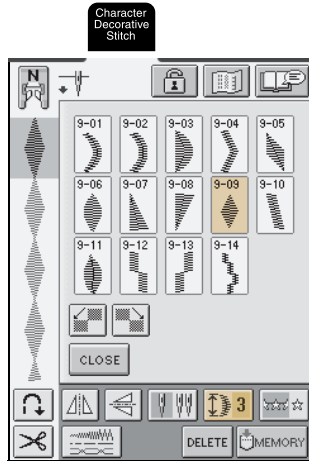

- 2 Press , and then press  once so that it appears as .



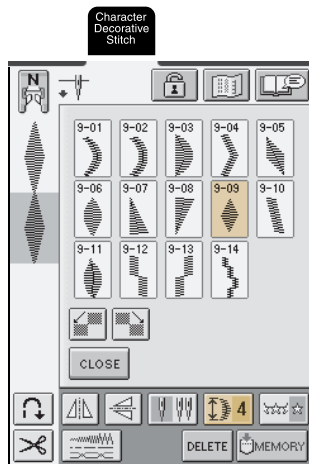

→ The pattern is displayed with a length of 4.

- 3 Press  again, and then press  three times so that it appears as .



→ The second pattern is displayed with a length of 2.

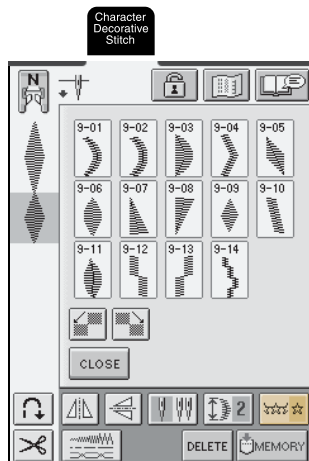

- 4 To repeatedly sew the pattern combination, press  so that it appears as .





→ The combination appears as a repeating pattern.

## Creating Step Patterns (7 mm Satin Stitch Patterns Only)

Stitch patterns that are shifted to create a step-shaped pattern are called step patterns.

Step patterns can be created by using  and  to shift 7 mm satin stitch patterns.

Press  once to move the stitch pattern to the left by half the width of the stitch pattern.

Press  once to move the stitch pattern to the right by half the width of the stitch pattern.

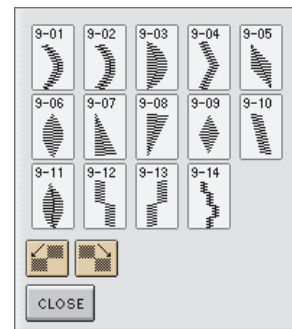



Example:



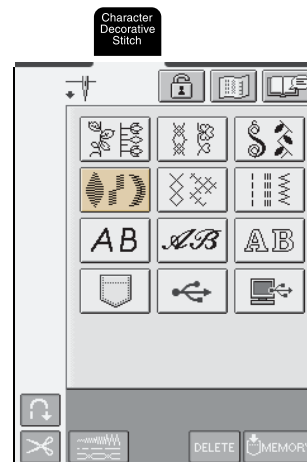

- 1 Press .



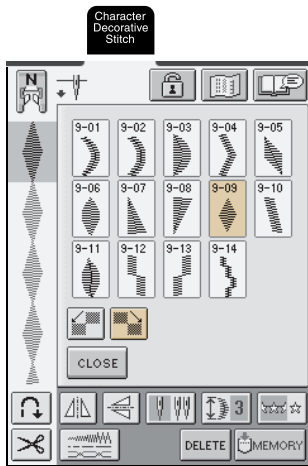

2 Press , and then press .

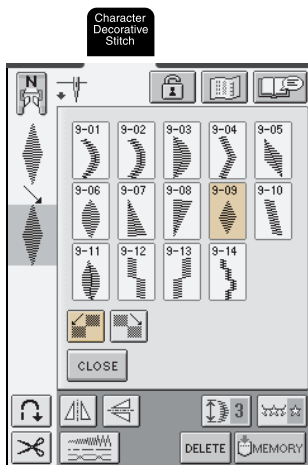

→ The next pattern is moved to the right.

3 Press  again, and then press .



4 Press  so that it appears as .

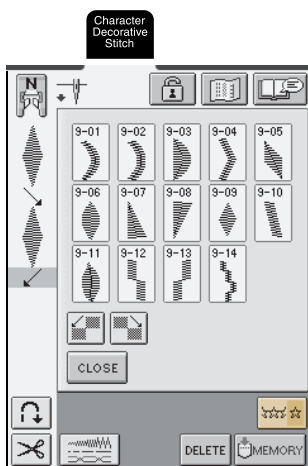

→ The combination appears as a repeating pattern.

### Examples of Pattern Combinations

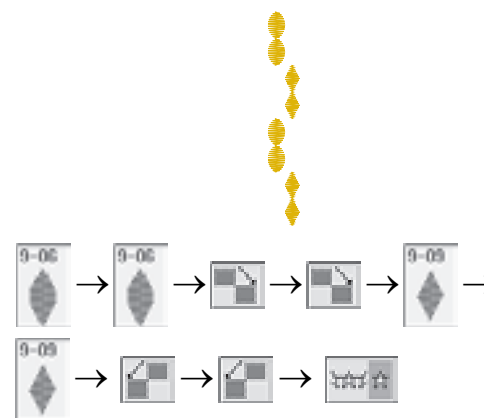
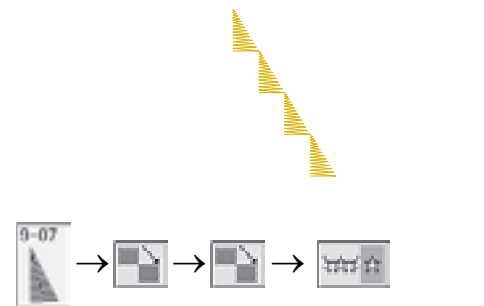
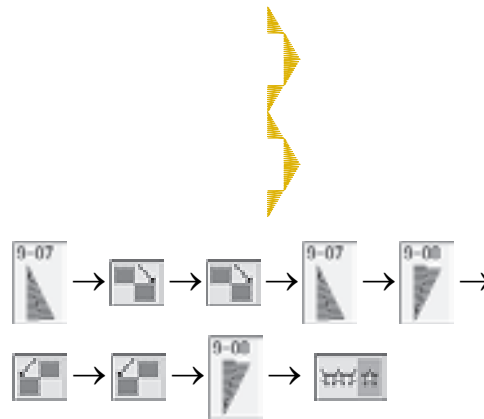
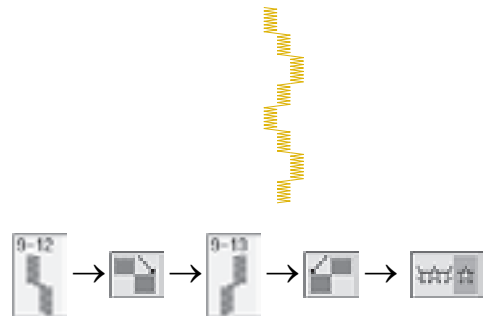

4

Character/Decorative Stitches

# USING THE MEMORY FUNCTION

## Stitch Data Precautions

Observe the following precautions when using stitch data other than that created and saved in this machine.

### ■ Types of Stitch Data that can be Used

- Only .pmu stitch data files can be used with this machine. Using data other than that created using this machine may cause the machine to malfunction.

### ■ Types of USB Devices/Media that can be Used

Stitch data can be saved to or recalled from USB media. Use media that meets the following specifications.

- USB Floppy disk drive
- USB Flash drive (USB Flash memory)
- USB CD-ROM, CD-R, CD-RW drives (recalling only)



### Memo

Stitch/embroidery data cannot be saved using a USB CD-ROM, CD-R or CD-RW drive.

You can also use the following types of USB media with the USB Memory Card Reader/Writer.

- Secure Digital (SD) Card
- CompactFlash
- Memory Stick
- Smart Media
- Multi Media Card (MMC)
- XD-Picture Card



### Note

- Some USB media may not be usable with this machine. Please visit our web site for more details.
- USB hubs cannot be used with this machine. The machine will not recognize the above USB devices or USB memory cards through a USB hub.
- The access lamp will begin blinking after inserting USB Devices/Media, and it will take about 5 to 6 seconds to recognize the Devices/Media. (Time will differ depending on the USB Device/Media).



### Memo

- When a file folder is necessary to create, use a computer.
- Letters and numerals can be used in the file names. In addition, if the file name contains no more than eight characters, the entire file name will appear on the screen.  
If the file name is more than eight characters long, only the first six characters followed by “~” and a number appear as the file name.

### ■ Computers and Operating Systems with the Following Specifications can be Used

- Compatible models:  
IBM PC with a USB port as standard equipment  
IBM PC-compatible computer equipped with a USB port as standard equipment
- Compatible operating systems:  
Microsoft Windows Me/2000/XP  
(Windows 98SE requires a driver. Download the driver from our web site ([www.babylock.com](http://www.babylock.com))).



## ■ Precautions on Using the Computer to Create and Save Data

- If the name of the stitch data file/folder cannot be identified, for example, because the name contains special characters, the file/folder is not displayed. If this occurs, change the name of the file/folder. We recommend using the 26 letters of the alphabet (uppercase and lowercase), the numbers 0 through 9, “-”, and “\_”.
- Stitch data in a folder created in USB media can be retrieved.
- Do not create folders in “Removable Disk” on a computer. If stitch data is stored in a folder in “Removable Disk”, that stitch data cannot be retrieved by the machine.

## ■ Trademarks

- Secure Digital (SD) Card is a registered trademark or a trademark of SD Card Association.
- CompactFlash is a registered trademark or a trademark of Sandisk Corporation.
- Memory Stick is a registered trademark or a trademark of Sony Corporation.
- Smart Media is a registered trademark or a trademark of Toshiba Corporation.
- Multi Media Card (MMC) is a registered trademark or a trademark of Infineon Technologies AG.
- xD-Picture Card is a registered trademark or a trademark of Fuji Photo Film Co. Ltd.
- IBM is a registered trademark or a trademark of International Business Machines Corporation.
- Microsoft and Windows are registered trademarks or trademarks of Microsoft Corporation.

Each company whose software title is mentioned in this manual has a Software License Agreement specific to its proprietary programs.

All other brands and product names mentioned in this manual are registered trademarks of their respective companies. However, the explanations for markings such as © and ™ are not clearly described within the text.



4

## Saving Stitch Patterns in the Machine's Memory

You can save often-used stitch patterns in the machine's memory. The machine's memory can hold up to 16 stitch patterns.

### Note

Do not turn off the machine while the "Saving" screen is displayed, otherwise you may lose the stitch pattern that you are saving.

### Memo

- It takes a few seconds to save a stitch pattern in the machine's memory.
- See page 115 for information on retrieving a saved stitch pattern.

1 Press **MEMORY**.



2 Press **MEMORY**.

- \* Press **CLOSE** to return to the previous screen without saving the stitch pattern.



→ The "Saving" screen appears. When the pattern is saved, the previous screen appears automatically.

## If the Memory Is Full

If this screen appears while you are trying to save a pattern on the machine's memory, the memory is too full to hold the currently selected stitch pattern. To save the stitch pattern in the machine's memory, you have to delete a previously saved stitch pattern.

1 Press **DELETE**.

- \* Press **CANCEL** to return to the previous screen without saving the stitch pattern.

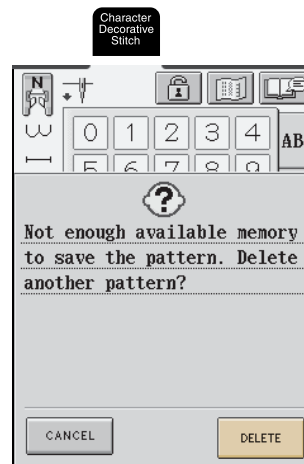

2 Select a stitch pattern to be deleted.

- \* Press **MEMORY** to display the pattern saved in that pocket.
- \* Press **CLOSE** if you do not want to delete the stitch pattern.

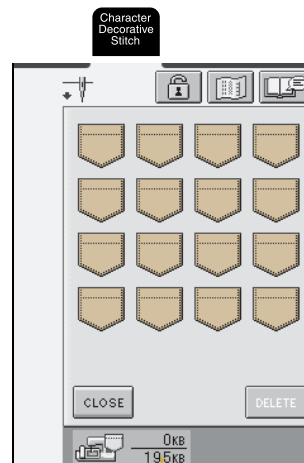

① Total amount of machine memory available for saving patterns

3 Press **DELETE**.

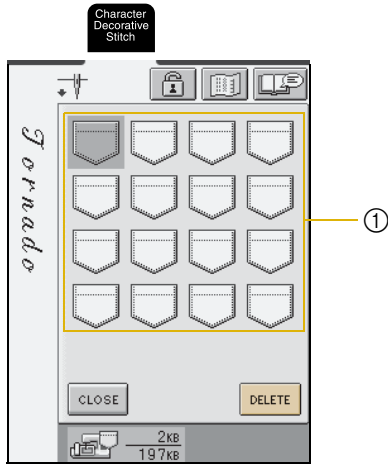

① Pockets holding saved stitch patterns  
→ A confirmation message appears.

4 Press **OK**.

\* If you decide not to delete the stitch pattern, press

**CANCEL**.

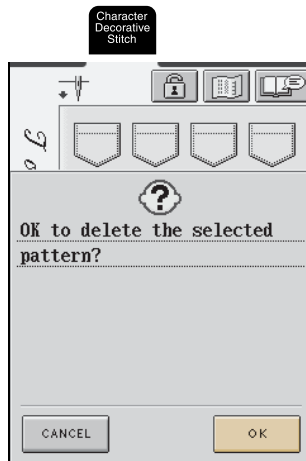

→ The old stitch pattern is deleted, and the new stitch pattern is automatically saved.

## Saving Stitch Patterns to USB Media (Commercially Available)

When sending stitch patterns from the machine to USB media, plug the USB media into the machine's USB port. Depending on the type of USB media being used, either directly plug the USB device into the machine's USB port or plug the USB Card Writer/Reader into the machine's USB port.

### Memo

Some USB media may not be usable with this machine. Please visit our web site for more details.

1 Press **MEMORY**.



2 Insert the USB media into the USB port connector on the machine.

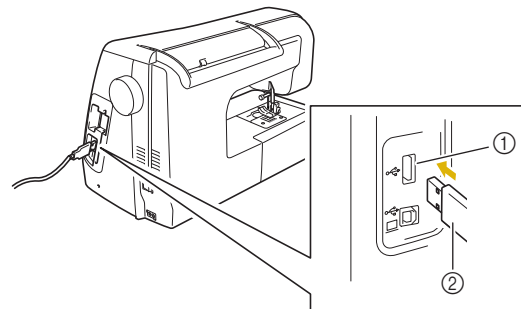

- ① USB port connector for media
- ② USB media

### Memo

Do not insert anything other than USB media into the USB media port connector. Otherwise, the USB media drive may be damaged.



4

Character/Decorative Stitches

**3** Press  .

\* Press  to return to the original screen without saving.



→ The "Saving" screen is displayed. When the pattern is saved, the display returns to the original screen automatically.



**Note**

Do not unplug the USB media or eject the floppy disk while the "Saving" screen is displayed, otherwise the USB media may be damaged or data may be lost.

## Saving Stitch Patterns to the Computer

Using the included USB cable, connect the sewing machine to your computer so that stitch patterns can be retrieved from and saved to your computer.



**Note**

Do not turn off the machine while the "Saving" screen is displayed, otherwise you may lose the stitch pattern that you are saving.

**1**

**Plug the USB cable connectors into the corresponding USB port connectors on the computer and on the machine.**

\* The USB cable can be plugged into the USB port connectors on the computer and machine whether or not they are turned on.

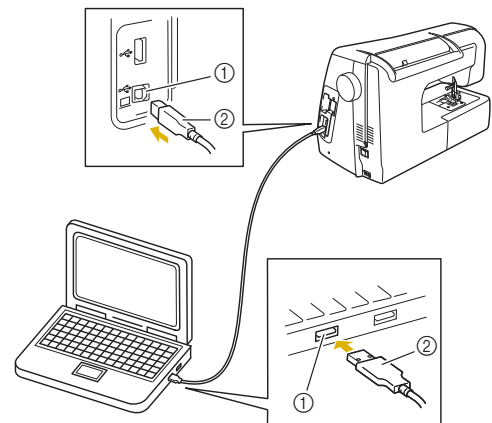

- ① USB port connector for computer
- ② USB cable connector

→ The "Removable Disk" icon appears in "My Computer" on the computer.



**Note**

- The connectors on the USB cable can only be inserted into a port in one direction. If it is difficult to insert the connector, do not insert it with force, and then check the orientation of the connector.
- For details on the position of the USB port connector on the computer, refer to the instruction manual for the corresponding equipment.

2 Press .



3 Press .

→ Press **CLOSE** to return to the previous screen without saving the stitch pattern.



→ The stitch pattern is temporarily saved to "Removable Disk" under "My Computer".

4 Select the stitch pattern's .pmu file in "Removable Disk", and copy the file to the computer.



**Note**  
Do not turn off the machine while the "Saving" screen is displayed, otherwise you may lose the data.

## Retrieving Stitch Patterns from the Machine's Memory

1 Press .

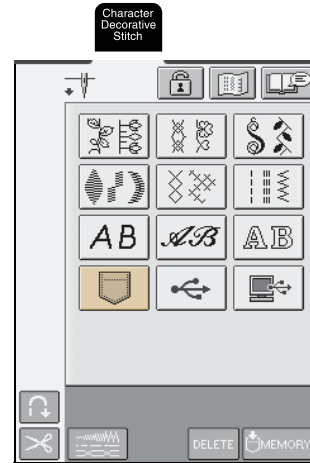

→ The pocket selection screen appears.

2 Select a stitch pattern to be retrieved.

- \* Press  so that the pattern saved in that pocket appears.
- \* Press **CLOSE** to return to the previous screen without retrieving the stitch pattern.

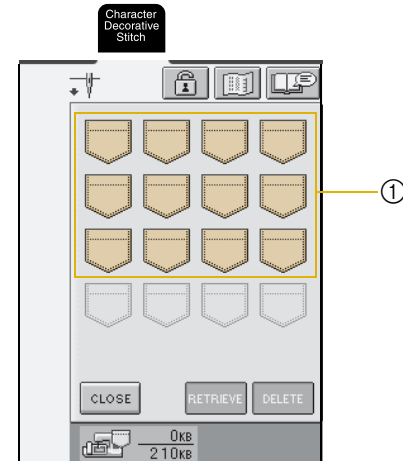

① Pockets holding saved stitch patterns



4

Character/Decorative Stitches

3 Press **RETRIEVE**.

\* Press **DELETE** to delete the stitch pattern.

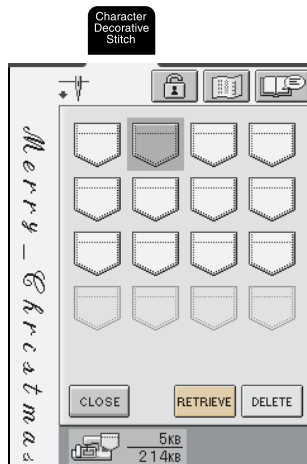

→ The selected stitch pattern is retrieved and the sewing screen appears.

## Retrieving stitch pattern from USB Media

You can retrieve a specific stitch pattern from either directly USB media or a folder in the USB media. If the stitch pattern is under the folder, move down layers of folders following a path to it.

1 Insert the USB Media into the USB port connector on the machine (see page 113).

2 Press **USB**.

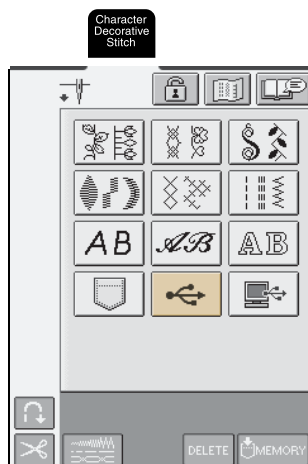

3 Press **MESSAGES** when there are subfolders to sort two or more stitch patterns to USB media, the stitch patterns in the subfolders are displayed.

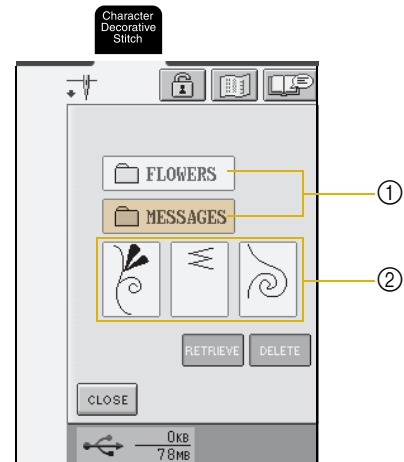

- ① Folder names
- ② Stitch patterns in a top folder ("key" shows only the first pattern over if the pattern is combined.)

→ Stitch patterns and folders in the subfolder are displayed.

4 Press the key of the stitch pattern you want to retrieve.

\* Press **CLOSE** to return to the original screen without retrieving.

\* Press **BACK** to return to the previous folder.



**5** Press **RETRIEVE**.

\* Press **DELETE** to delete the stitch pattern.

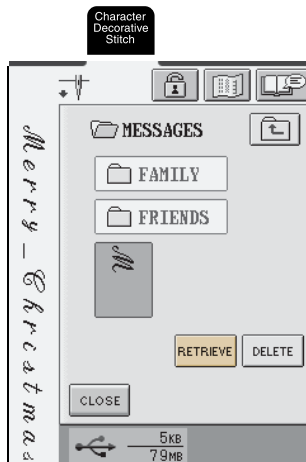

→ The selected stitch pattern is retrieved and the sewing screen appears.

**Note**

Do not unplug the USB media or eject the floppy disk or CD while a stitch pattern is being read or deleted, otherwise the USB media may be damaged or data may be lost. In addition, do not unplug the USB media or eject the floppy disk or CD while the contents of the USB media, floppy disk or CD are displayed.

## Retrieving Stitch Patterns from the Computer

**1** Plug the USB cable connectors into the corresponding USB port connectors on the computer and on the machine (see page 114).

**2** On the computer, open “My Computer”, and then go to “Removable Disk”.



**3** Move/copy the pattern data to “Removable Disk”.



→ Stitch pattern data in “Removable Disk” is written to the machine.

**Note**

- While data is being written, do not disconnect the USB cable.
- Do not create folders within “Removable Disk”. Since folders are not displayed, stitch pattern data within folders cannot be retrieved.



4

Character/Decorative Stitches

4 Press  .



→ The stitch patterns in the computer are displayed in the selection screen.

5 Select a stitch pattern to be retrieved.

\* Press  to return to the previous screen without saving the stitch pattern.

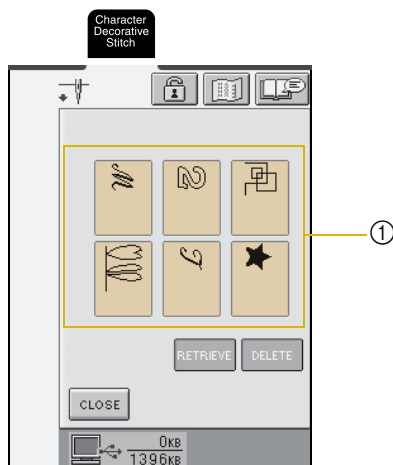

① Stitch keys holding saved stitch patterns

6 Press  .

\* Press  to delete the stitch pattern.

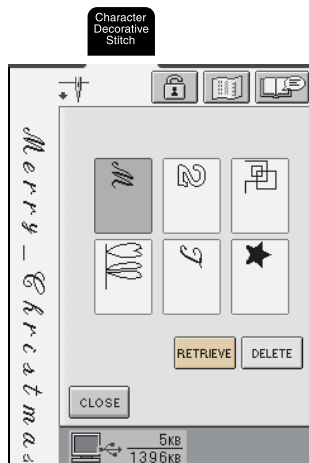

→ The selected stitch pattern is retrieved and the sewing screen appears.

## CAUTION

- When disconnecting the USB cable: Before disconnecting the USB cable, click the “Unplug or Eject Hardware” icon in the taskbar of Windows® Me/2000 or the “Safely Remove Hardware” icon in the taskbar of Windows® XP. Then, when the removable disk has been removed safely, disconnect the USB cable from the computer and the machine.



With Windows 98SE, check that the Access lamp is not flashing before disconnecting the USB cable from the computer and the machine.

## Note

The pattern retrieved from the computer is only temporarily written to the machine. It is erased from the machine when the machine is turned off. If you wish to keep the stitch pattern, store it in a pocket on the machine (see “Saving Stitch Patterns in the Machine’s Memory” on page 112).





# Chapter 5

## Embroidery

### BEFORE EMBROIDERING ..... 120

Attaching Embroidery Foot "U".....	121
Attaching the Embroidery Unit.....	122
■ Removing the Embroidery Unit.....	123

### SELECTING EMBROIDERY PATTERNS ..... 124

■ Copyright Information.....	124
■ Pattern Selection Screens.....	124
Embroidery Patterns/Floral Patterns/ Baby Lock Exclusive Embroidery Designs .....	125
Alphabet Patterns .....	125
Frame Patterns.....	126
Embroidery Cards .....	127
■ About Embroidery Cards (Sold Separately).....	127
Selecting Patterns from the Machine's Memory/ USB Media/Computer.....	127

### VIEWING THE SEWING SCREEN ..... 128

■ Key Functions.....	128
----------------------	-----

### PREPARING THE FABRIC ..... 129

Attaching Stabilizer to Fabric .....	129
Hooping Fabric in the Embroidery Frame .....	130
■ Types of Embroidery Frames .....	130
■ Inserting the Fabric .....	131
■ Using the Embroidery Sheet .....	131
Embroidering Small Fabrics and Fabric Edges .....	132
■ Embroidering Small Fabrics.....	132
■ Embroidering Edges or Corners.....	132
■ Embroidering Ribbons or Tape.....	132

### ATTACHING THE EMBROIDERY FRAME..... 133

■ Removing the Embroidery Frame .....	133
---------------------------------------	-----

### EDITING THE PATTERN ..... 134

Changing the Embroidery Frame Display.....	134
Changing the Pattern Position.....	135
Rotating the Pattern.....	135
Changing the Pattern Size.....	136
Creating a Horizontal Mirror Image .....	137
Changing the Stitching Density (Alphabet and Frame Patterns Only).....	138
Changing the Color of Single Characters .....	138

### CHECKING THE PATTERN ..... 139

Checking the Embroidering Position.....	139
Previewing the Pattern.....	140

### SEWING AN EMBROIDERING PATTERN .... 141

Sewing Attractive Finishes .....	141
■ Using Prewound Bobbins with Standard GREEN Marked Bobbin Case.....	141
■ Using Prewound Bobbins with Alternate Bobbin Case (no color on the screw) .....	141
■ Using Bobbin Center Pin (Spacer).....	141
■ Embroidery Needle Plate Cover .....	142
Sewing Embroidery Patterns .....	142
Embroidering Appliqué Patterns.....	143

### ADJUSTMENTS DURING THE EMBROIDERY PROCESS..... 145

If the Bobbin Runs Out of Thread.....	145
If the Thread Breaks During Sewing .....	146
Restarting from the Beginning .....	147
Automatically Resuming Embroidery When the Power Goes Off.....	147
Manually Resuming Embroidery After Turning Off the Power.....	148
Adjusting the Thread Tension .....	149
■ Correct Thread Tension .....	149
■ If the Upper Thread Is Too Tight.....	150
■ If the Upper Thread Is Too Loose.....	150
Automatic Thread Cutting (End Color Trim).....	150
Changing the Embroidering Speed.....	151
Changing the Thread Color Display.....	151

### USING THE MEMORY FUNCTION ..... 153

Embroidery Data Precautions .....	153
■ Types of Embroidery Data that can be Used .....	153
■ Types of USB Devices/Media that can be Used .....	153
■ Computers and Operating Systems with the Following Specifications Can Be Used .....	154
■ Precautions on Using the Computer To Create and Save Data.....	154
■ Tajima (.dst) Embroidery Data .....	154
■ Trademarks .....	154
Saving Embroidery Patterns in the Machine's Memory.....	155
■ If the Memory Is Full.....	155
Saving Embroidery Patterns to USB Media (Commercially Available) .....	156
Saving Embroidery Patterns to the Computer.....	157
Retrieving Embroidery Patterns from the Machine's Memory .....	158
Retrieving Embroidery Patterns from USB Media (Commercially Available) .....	159
Retrieving Embroidery Patterns from the Computer.....	160

### EMBROIDERY APPLICATIONS ..... 162

Using a Frame Pattern to Make an Appliqué (1) .....	162
Using a Frame Pattern to Make an Appliqué (2) .....	163

## BEFORE EMBROIDERING

The embroidering procedures are listed below.

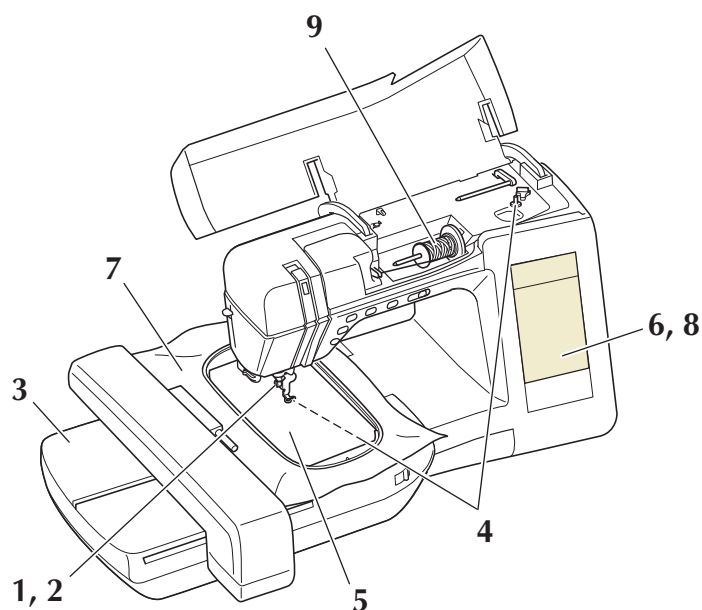

Step #	Operation	Page
1	Attach embroidery foot "U".	121
2	Insert a 75/11 home sewing machine needle.*	35
3	Attach the embroidery unit.	122
4	Wind the bobbin with embroidery bobbin thread, and then set the bobbin.	24, 27
5	Attach stabilizer material to the fabric, and then hoop it in the embroidery frame.	129
6	Turn on the machine, and then select the embroidery pattern.	124
7	Attach the embroidery frame to the embroidery unit.	133
8	Check and adjust the size and position of the embroidery pattern.	139
9	Set up embroidery thread according to the pattern (upper threading).	29

\* It is recommended that a 90/14 needle should be used when embroidering on heavy weight fabrics or stabilizing products (for example; denim, puffy foam, etc.).

## Attaching Embroidery Foot “U”

### ⚠ CAUTION

- When attaching a presser foot, always press  in the operation panel. You may accidentally press the “Start/Stop” button and possibly cause injury.
- Be sure to use embroidery foot “U” when doing embroidery. Using another presser foot may cause the needle to strike the presser foot, causing the needle to bend or break and possibly cause injury.

- 1 Press the “Needle Position” button to raise the needle.

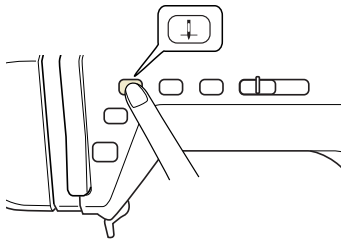

- 2 Press .

→ The Presser foot/Needle exchange screen appears and all keys and operation buttons are locked.

- 3 Raise the presser foot lever.

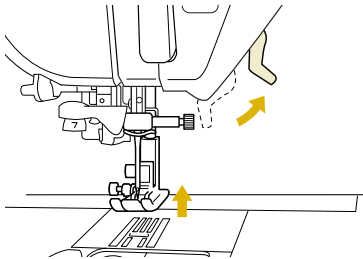

- 4 Press the black button on the presser foot holder to remove the presser foot.

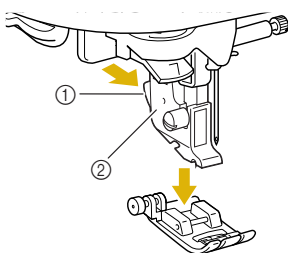

- ① Black button  
② Presser foot holder

- 5 Use the included screwdriver to loosen the presser foot holder screw, and then remove the presser foot holder.

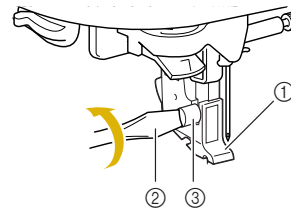

- ① Presser foot holder  
② Screwdriver  
③ Presser foot holder screw

- 6 Attach embroidery foot “U” so that the presser foot holder screw fits into the notch in the foot.

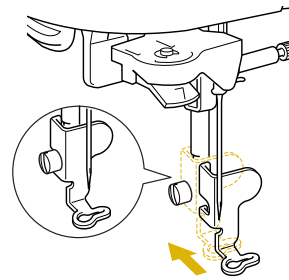

\* Make sure that embroidery foot “U” is vertical when it is installed.

- 7 Hold the embroidery foot in place with your right hand, and then use the included screwdriver to securely tighten the presser foot holder screw.

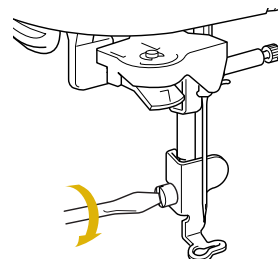

### ⚠ CAUTION

- Use the included screwdriver to firmly tighten the screw of the presser foot holder. If the screw is loose, the needle may strike the presser foot and possibly cause injury.

- 8 Press , or  in the screen that appeared.

→ All keys and operation buttons are unlocked, and the previous screen is displayed.



5

Embroidery

## Attaching the Embroidery Unit

### CAUTION

- Do not move the machine with the embroidery unit attached. The embroidery unit could fall off and cause injury.
- Keep your hands and foreign objects away from the embroidery carriage and frame when the machine is embroidering. Otherwise, injury may result.
- If the embroidery unit could not be initialized correctly, a buzzer will sound. If this happens, go through the initialization process again. This is not a malfunction.

### Note

- Do not touch the embroidery unit connector, otherwise damage to the connector pins or the machine may result.
- Do not apply extreme force to the embroidery unit carriage or pick up the unit by the carriage, otherwise damage to the embroidery unit may result.
- Store the embroidery unit in its storage box/case.

- 1 Turn off the machine, and then remove the flat-bed attachment.

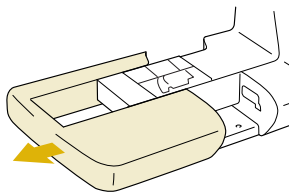

### Note

Be sure to turn off the machine before attaching the embroidery unit, otherwise damage to the machine may result.

- 2 Slide the tab on the cover of the connection port in the direction of the arrow to open the cover.

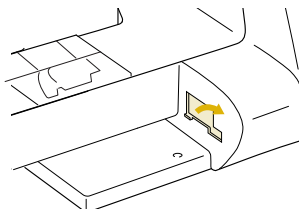

### Note

Be sure to close the cover of the connection port when the embroidery unit is not being used.

- 3 Insert the embroidery unit connector into the connection port, and then lightly push in the embroidery unit until it snaps into place.

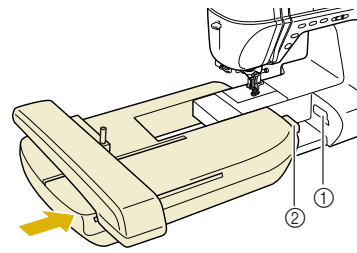

- ① Connection port
- ② Embroidery unit connector

### Note

- Make sure that there is no gap between the embroidery unit and the sewing machine, otherwise the embroidery pattern may not be sewn correctly. Be sure to fully insert the connector into the connection port.
- Do not push on the carriage when attaching the embroidery unit to the machine, otherwise damage to the embroidery unit may result.

- 4 Turn on the machine.

→ A message appears in the screen.

5 Press .

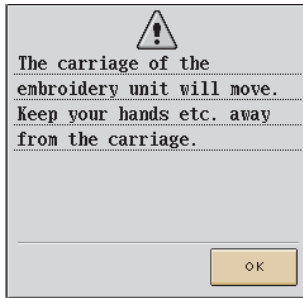

→ The carriage moves to its initial position.

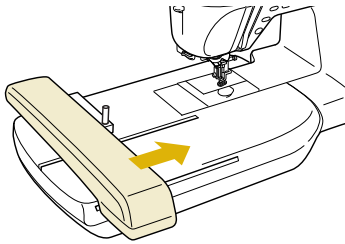

### CAUTION

- Keep your hands and foreign objects away from the embroidery carriage and frame when the machine is embroidering. Otherwise, injury may result.



#### Note

If the machine was not initialized correctly, the initial screen may not appear. This is not a sign of a malfunction. If this occurs, turn the machine off, then on again.

6 The following message will disappear after 15 seconds or press  to move to the next step.

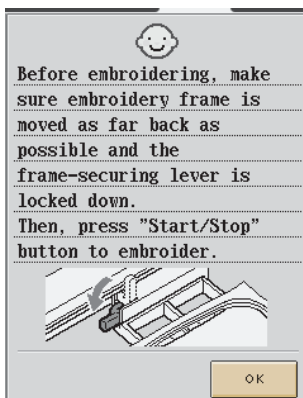

#### Note

- The confirmation message to lower the frame-securing lever after the carriage moves to its initial position is displayed.
- Continue with pattern selection and remember to lower the frame-securing lever when the embroidery frame is attached.

→ Pattern selection screen appears.

## Removing the Embroidery Unit

1 Press  or , and then press .

→ The carriage moves to the storage position.

### CAUTION

- Always remove the embroidery frame before pressing . Otherwise, the frame may strike the embroidery foot, and possibly cause injury.
- The embroidery unit will not fit in the storage box/case if this step is not done.



#### Note

If the carriage does not move to the storage position, the embroidery unit cannot be put into its storage box/case.

2 Turn off the machine.



#### Note

Be sure to turn off the machine before removing the embroidery unit, otherwise damage to the machine may result.

3 Press the release button under the end of the embroidery unit, and then pull the unit away from the machine.

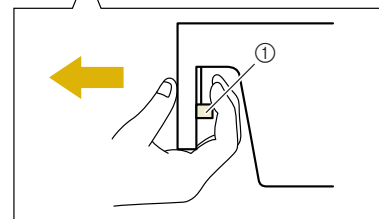
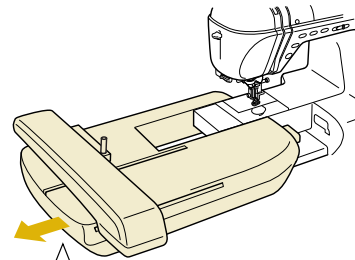

① Release button

### CAUTION

- Do not carry the embroidery unit by holding the release button compartment.

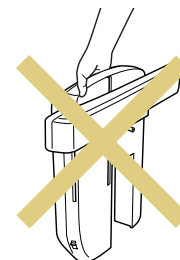

5

Embroidery

# SELECTING EMBROIDERY PATTERNS

## ■ Copyright Information

The embroidery patterns stored in the machine and on embroidery cards (sold separately) are intended for private use only. Any public or commercial use of copyrighted patterns is an infringement of copyright law and is strictly prohibited.

## ■ Pattern Selection Screens

There are many character and decorative embroidery patterns programmed in the machine. When the carriage moves to its initial position, a screen appears so that you can select a pattern. If a different screen is displayed, press .

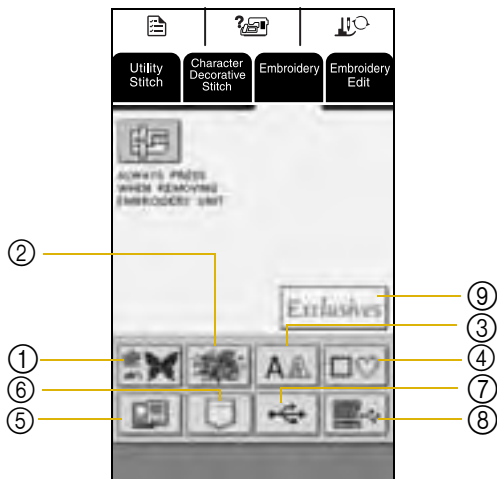

① Embroidery patterns

② Floral patterns

③ Alphabet patterns

④ Frame patterns

⑤ Embroidery cards (sold separately)

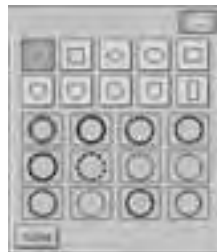

⑥ Patterns saved in the machine's memory

⑦ Patterns saved in USB media

⑧ Patterns saved on the computer

⑨ Baby Lock Exclusive Embroidery Designs

The screen that appears differs depending on the card that is inserted.



Press  to display the previous or next page.

## Embroidery Patterns/Floral Patterns/ Baby Lock Exclusive Embroidery Designs

1 Select a type of embroidery pattern.



2 Select an embroidery pattern.

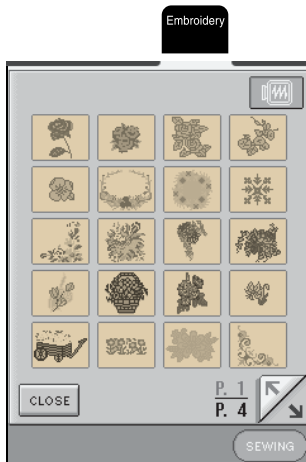

3 Press **SEWING**.

\* Press  to view an image of the embroidery pattern.

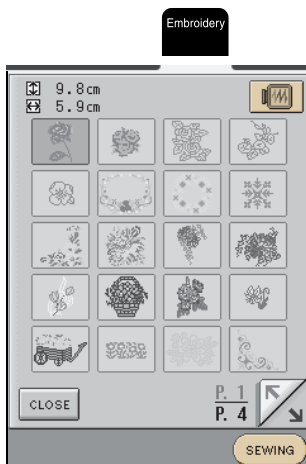

→ The sewing screen appears.

4 Continue with “VIEWING THE SEWING SCREEN” on page 128.

\* To select a different embroidery pattern, press **RETURN**. (After a confirmation message to delete the selected pattern appears, the pattern selection screen appears.)

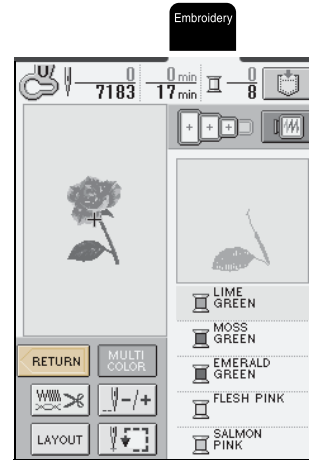

## Alphabet Patterns

1 Press **AA**.

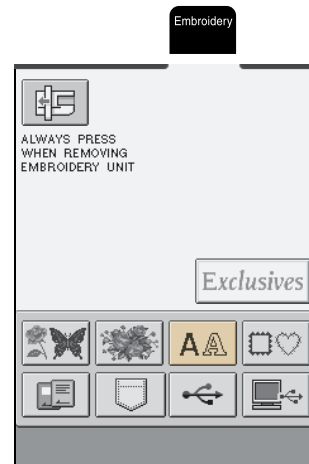



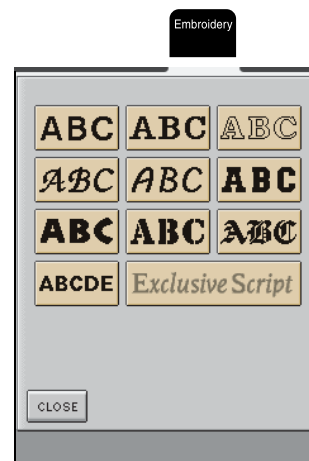

2 Select a character style.

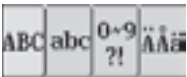

5

Embroidery

**3** Press  to display a selection screen of characters, and then select a character to be embroidered.

- \* To change the size, press  until the desired size is selected.
- \* If a wrong character was selected, press  to erase the character.
- \* Press  to display all entered characters.

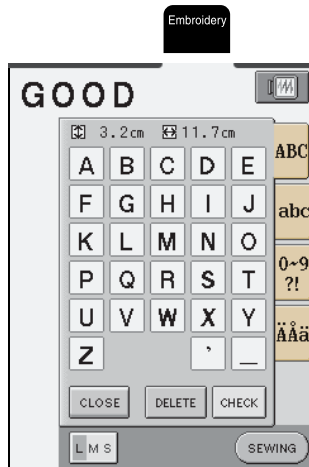

**Memo**

- The next character that is selected will have the new character size.
- You cannot change the size of characters once they have been combined.

**4** Press .

- \* Press  to view an image of the embroidery pattern.

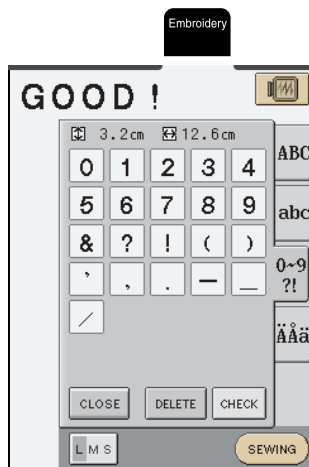

→ The sewing screen appears.

**5** Continue with “VIEWING THE SEWING SCREEN” on page 128.

- \* To select a different character, press  .  
(After a confirmation message to delete the selected pattern appears, the pattern selection screen appears.)



**Frame Patterns**

**1** Press .

**2** In the top part of the screen, select a frame shape. In the bottom part of the screen, select a frame pattern.

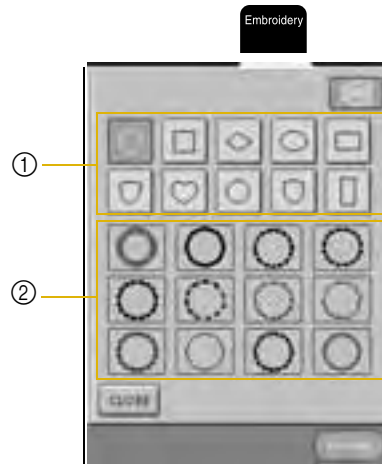

- ① Frame shapes
- ② Frame patterns



**3** Press  .

\* Press  to view an image of the embroidery pattern.

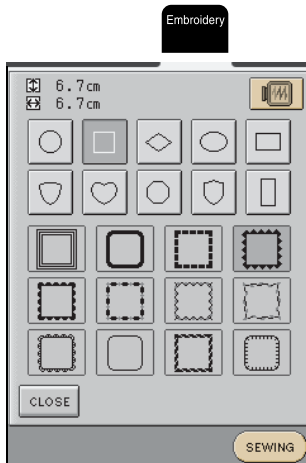

→ The sewing screen appears.

**4** Continue with “VIEWING THE SEWING SCREEN” on page 128.

\* To select a different embroidery pattern, press  . (After a confirmation message to delete the selected pattern appears, the pattern selection screen appears.)

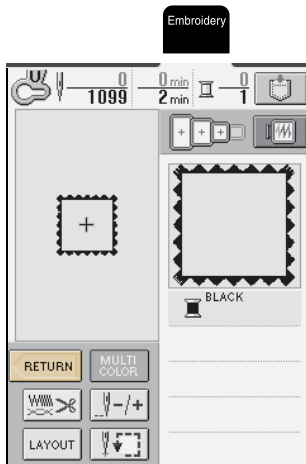

**Note**

Do not insert the embroidery card in a direction other than that shown by the arrow on the card, do not insert the card with extreme force, and do not insert any object other than embroidery cards into the slot, otherwise the machine may be damaged.

**1** With the side of the embroidery card marked with an arrow facing toward you, fully insert the card into the embroidery card slot on the right side of the machine.

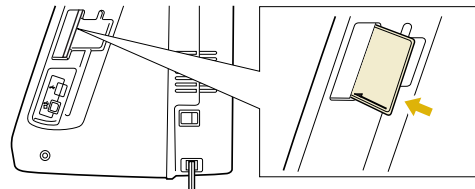

**2** Press  .

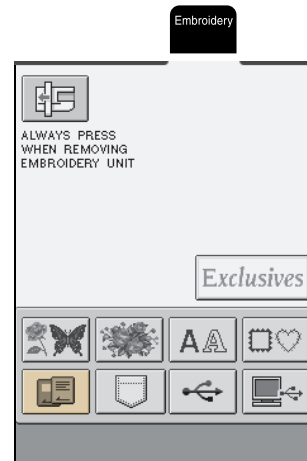

→ The pattern selection screen for the card appears.

**3** Follow the procedure described in “Embroidery Patterns/Floral Patterns/Baby Lock Exclusive Embroidery Designs” on page 125 to select a pattern.

**Embroidery Cards**

**About Embroidery Cards (Sold Separately)**

- If an embroidery card other than our original embroidery cards is used, the machine may not operate correctly. Be sure to use only embroidery cards manufactured for this machine.
- Embroidery cards purchased in foreign countries may not work with this machine.
- Only insert or remove the embroidery card when  is displayed, or when the machine is turned off.
- Store embroidery cards in their protective cases.
- Please see your Baby Lock retailer for embroidery cards available.

**Selecting Patterns from the Machine's Memory/USB Media/Computer**

To retrieve patterns from the machine's memory, USB media, or computer, see page 158.



# VIEWING THE SEWING SCREEN

Using the editing keys, you can change the patterns in a variety of ways, such as resizing them or rotating them.

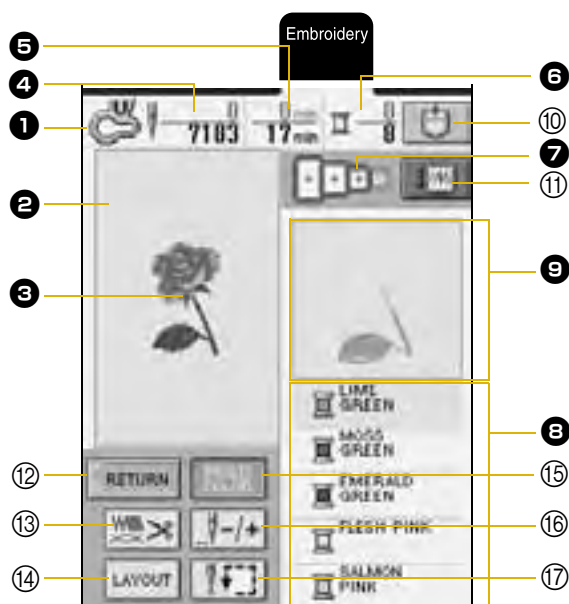

- ① Shows the code for the appropriate presser foot. When embroidering, be sure to use embroidery foot “U”.
- ② Shows the embroidering area for the extra large frame (26 cm × 16 cm (approx. 10-1/4 inches × 6-1/4 inches)).
- ③ Shows the selected pattern.
- ④ Shows the total number of stitches in the selected pattern and the number of stitches that have already been sewn.
- ⑤ Shows the total amount of time required to sew the pattern and the amount of time that has already been spent sewing (not including the amount of time required to change threads).
- ⑥ Shows the number of colors in the selected pattern and the number of the color currently being sewn.
- ⑦ Shows the embroidery frames that can be used with the selected pattern. Be sure to use the correct frame (see page 130).
- ⑧ Shows the order in which the colors are sewn. Embroider in order, starting from the top.
- ⑨ Shows the part of the embroidery that will be sewn.

## ■ Key Functions

No.	Key	Name	Function	Page
⑩		Memory key	Press this key to save the pattern.	155 – 158
⑪		Image key	Press this key to display a preview of the embroidery pattern and check the frame size.	140
⑫		Return key	Press this key to display the screen of pattern categories.	–
⑬		Thread settings key	Press this key to set trimming at the end of colors steps, or to adjust the thread tension and sewing density.	138, 149–150
⑭		Layout key	Press this key to change the pattern layout.	135 – 137
⑮		Multi color key	Press this key to change the color of each letter when sewing alphabet character patterns.	138
⑯		Forward/Back key	Press this key to move the needle forward or backward in the pattern. This is useful if the thread breaks during sewing or if you want to embroider a specific area again.	146–147, 148
⑰		Trial key	Press this key to move the embroidery frame and check the embroidering position or to change the needle position before embroidering.	139



### Memo

Depending on the pattern that is selected, some editing functions may not be available. Keys that appear in light gray are not available.

# PREPARING THE FABRIC

## ⚠ CAUTION

- Use fabrics with a thickness of less than 3 mm (approx. 1/8 inch). Using fabrics thicker than 3 mm (approx. 1/8 inch) may cause the needle to break.
- When using layers with thicker batting etc., you can sew more attractive embroidery by adjusting the embroidery presser foot height in the embroidery settings screen (see below).
- In the case of thick terry cloth towels we recommend that you place a piece of water soluble stabilizer on the top surface of the towel. This will help to reduce the nap of the toweling and result in more attractive embroidery.

### 📖 Memo

With this machine, the height of embroidery foot “U” is automatically set according to the thickness of the fabric being embroidered. When embroidering thicker fabric, for example, fabric filled with batting, adjust the height of the presser foot in the settings screen.

Press **Embroidery**, and then press **−** or **+** in the PRESSER FOOT HEIGHT display on P. 3 of the screen to adjust the height of the presser foot according to the thickness of the fabric.

To raise the presser foot, increase the setting (see page 20). (Normally, the height is set to 1.5 mm.)



## Attaching Stabilizer to Fabric

For best results, always use stabilizer material for embroidery. In order to prevent shrinkage of the stitching or misaligned patterns, observe the following. When embroidering fabrics that cannot be ironed (such as towels or fabrics with loops that expand when ironed) or when embroidering an area that is difficult to iron, place the stabilizer material under the fabric without attaching it, and then hoop the fabric and the stabilizer in the embroidery frame.

## ⚠ CAUTION

- Always use a stabilizer material for embroidery when sewing stretch fabrics, lightweight fabrics, fabrics with a coarse weave, or fabrics which cause pattern shrinkage. Otherwise, the needle may break and cause injury. Not using a stabilizer material may result in a poor finish to your project.

### 1 Prepare the stabilizer material for embroidering.

- \* Use a piece of stabilizer material that is larger than the embroidery frame. When hooping the fabric in the embroidery frame, be sure that the stabilizer material is clamped in place on all edges in order to prevent wrinkles in the fabric.

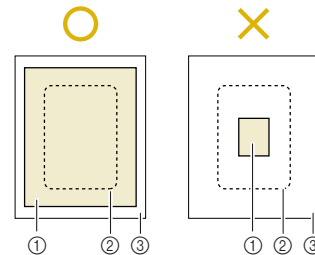

- ① Stabilizer
- ② Size of the embroidery frame
- ③ Fabric

### 2 Using a steam iron, iron the stabilizer material to the wrong side of the fabric.

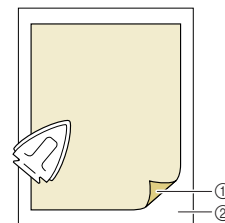

- ① Fusible side of stabilizer
- ② Fabric (wrong side)

### 📖 Memo

When embroidering lightweight fabrics, such as organdy or lawn, or when embroidering napped fabrics, such as towel or corduroy, use water-soluble stabilizer (sold separately) for best results. The water-soluble stabilizer material will dissolve completely in water, giving the embroidery a more attractive finish.

## Hooping Fabric in the Embroidery Frame

### Types of Embroidery Frames

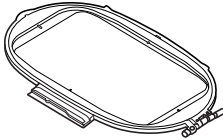
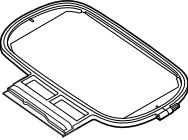
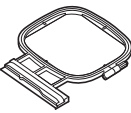
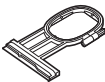
Extra Large	Large	Medium	Small (Sold Separately)
			
Embroidering area: 26 cm × 16 cm (approx. 10 - 1/4 inches × 6 - 1/4 inches)	Embroidering area: 18 cm × 13 cm (approx. 7 inches × 5 inches)	Embroidering area: 10 cm × 10 cm (approx. 4 inches × 4 inches)	Embroidering area: 2 cm × 6 cm (approx. 1 inch × 2 - 1/2 inches)
Use when embroidering connected or combined characters or patterns, or when embroidering large patterns.	Use when embroidering patterns with a size less than 18 cm × 13 cm (approx. 7 inches × 5 inches).	Use when embroidering pattern with a size less than 10 cm × 10 cm (approx. 4 inches × 4 inches)	Use when embroidering small-sized patterns, such as name tags.

Select a frame appropriate for the pattern size. The frame options are displayed in the screen.

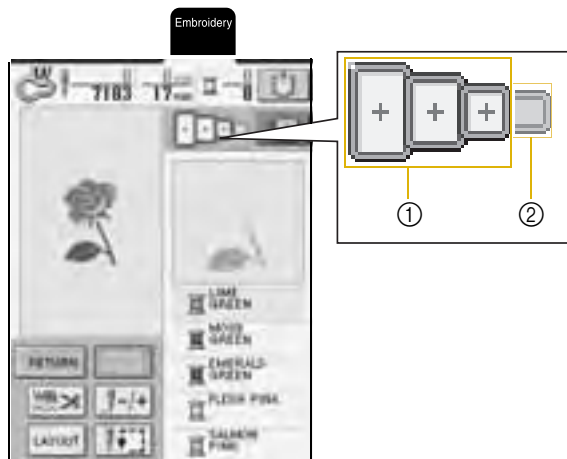

- ① Can be used
- ② Cannot be used

### CAUTION

- If you use a frame that is too small, the presser foot may strike the frame during sewing and cause injury.

## ■ Inserting the Fabric



### Note

If the fabric is not taut, the pattern may be misaligned or the fabric may pucker. Follow the procedure described below to gently stretch the fabric in the embroidery frame so that the fabric is not loose. In addition, be sure to work on a level surface when hooping the fabric in the embroidery frame.

- 1 Lift up and loosen the frame adjustment screw, and then remove the inner frame.**

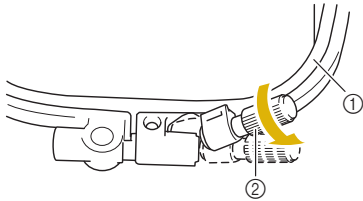

- ① Inner frame
- ② Frame adjustment screw

- 2 Lay the fabric right side up on top of the outer frame, and then place the inner frame on top.**

\* Be sure to align  $\triangle$  on the inner frame with  $\nabla$  on the outer frame.

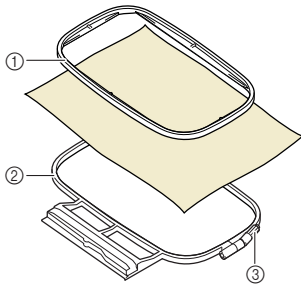

- ① Inner frame
- ② Outer frame
- ③ Frame adjustment screw

- 3 Slightly tighten the frame adjustment screw, and then gently pull the edges of the fabric to remove any slack.**

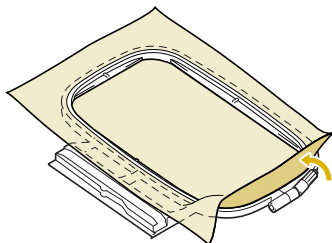

- 4 Gently stretch the fabric, and then securely tighten the frame adjustment screw so that the fabric remains stretched.**

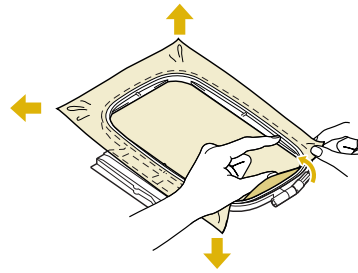

\* Make sure that the edges of the inner and outer frames are aligned.

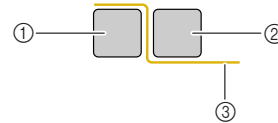

- ① Outer frame
- ② Inner frame
- ③ Wrong side of fabric



### Memo

- After stretching the fabric, lightly tapping it should produce a drum-like sound.
- While stretching the fabric from all four corners and all four edges, securely tighten the frame adjustment screw.

- 5 Return the frame adjustment screw to its original position.**

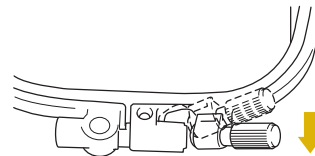

## ■ Using the Embroidery Sheet

When you want to embroider the pattern at a particular location, use the embroidery sheet to hoop the fabric in the embroidery frame.

- 1 Mark the area of the fabric to be embroidered.**

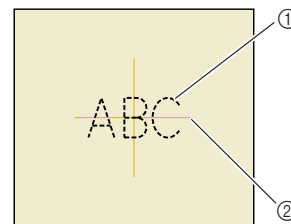

- ① Embroidery pattern
- ② Mark



5

Embroidery

- 2** Place the embroidery sheet in the inner frame, and then align the guide lines on the embroidery sheet with the marks on the fabric.

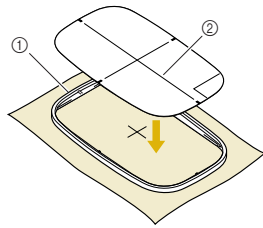

- ① Inner frame
- ② Guide lines

- 3** Stretch the fabric within the inner and outer frames so that there are no folds or wrinkles (see page 131).

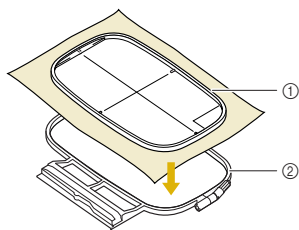

- ① Inner frame
- ② Outer frame

- 4** Remove the embroidery sheet.

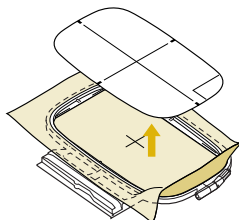

## Embroidering Small Fabrics and Fabric Edges

Use embroidery stabilizer to provide extra support. After embroidering, carefully remove the stabilizer.

### Embroidering Small Fabrics

When embroidering small pieces of fabric, use temporary spray adhesive to attach the small piece of the fabric to stabilizer, and then hoop the stabilizer in the embroidery frame. If you do not wish to use a temporary spray adhesive, attach the fabric to the stabilizer with basting stitches.

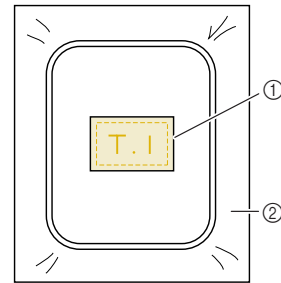

- ① Fabric
- ② Stabilizer

### Embroidering Edges or Corners

When embroidering corners or edges of fabric, use temporary spray adhesive to attach the corner or edge of the fabric to stabilizer, and then hoop the stabilizer in the embroidery frame. If you do not wish to use a temporary spray adhesive, attach the fabric to the stabilizer with basting stitches.

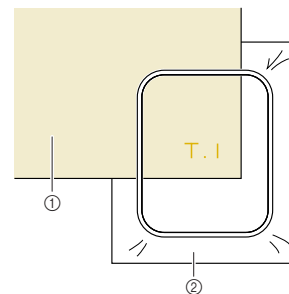

- ① Fabric
- ② Stabilizer

### Embroidering Ribbons or Tape

When embroidering narrow pieces of fabric, use temporary spray adhesive to attach the ribbon or tape to stabilizer, and then hoop the stabilizer in the embroidery frame. If you do not wish to use a temporary spray adhesive, hoop both ends of the ribbon or tape together with the stabilizer in the embroidery frame.

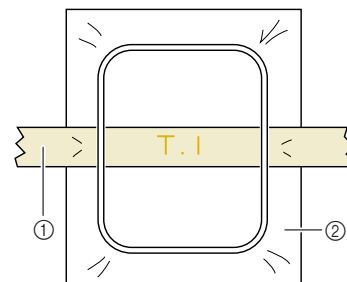

- ① Ribbon or tape
- ② Stabilizer

# ATTACHING THE EMBROIDERY FRAME



## Note

Before attaching the embroidery frame, set the bobbin.

- 1 Press the “Presser Foot Lifter” button to raise the presser foot.

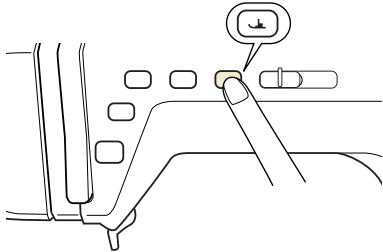

- 2 Raise the frame-securing lever.

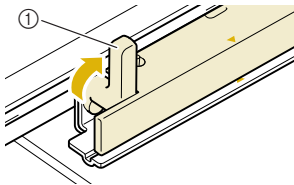

① Frame-securing lever

- 3 Align the embroidery frame guide with the right edge of the embroidery frame holder.

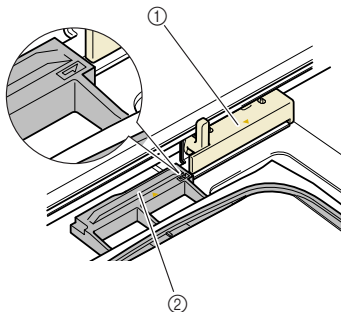

① Embroidery frame holder  
② Embroidery frame guide

- 4 Slide the embroidery frame into the holder, making sure that  $\triangle$  on the embroidery frame aligns with  $\nabla$  on the holder.

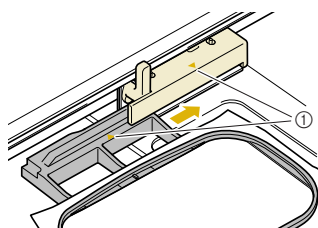

① Arrows

- 5 Lower the frame-securing lever so that it is level with the frame to secure the embroidery frame in the embroidery frame holder.

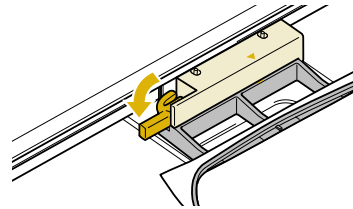

## CAUTION

- If the frame-securing lever is not lowered, the embroidery pattern may not sew out correctly or the presser foot may strike the embroidery frame and cause injury.

- 6 After the embroidery frame is attached, press the “Presser Foot Lifter” button again to lower the presser foot.

## ■ Removing the Embroidery Frame

- 1 Press the “Presser Foot Lifter” button to raise the presser foot.
- 2 Raise the frame-securing lever.

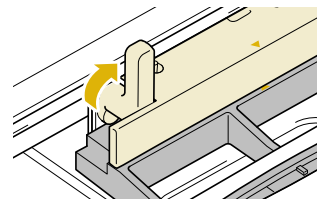

- 3 Pull off the embroidery frame toward you.

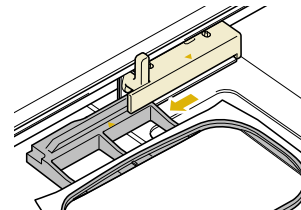

5



Embroidery

# EDITING THE PATTERN

## ! CAUTION

- After the size of the pattern has been changed, check the icons for the embroidery frames that can be used and use only the indicated frames. If a frame other those indicated is used, the presser foot may strike the embroidery frame, possibly causing injuries.

### Changing the Embroidery Frame Display

- 1 Press  .
- 2 Press  or  in the “EMBROIDERY FRAME DISPLAY” on P. 2 of the screen to select how the embroidery frame is displayed.

\* There are five embroidery frame layouts.

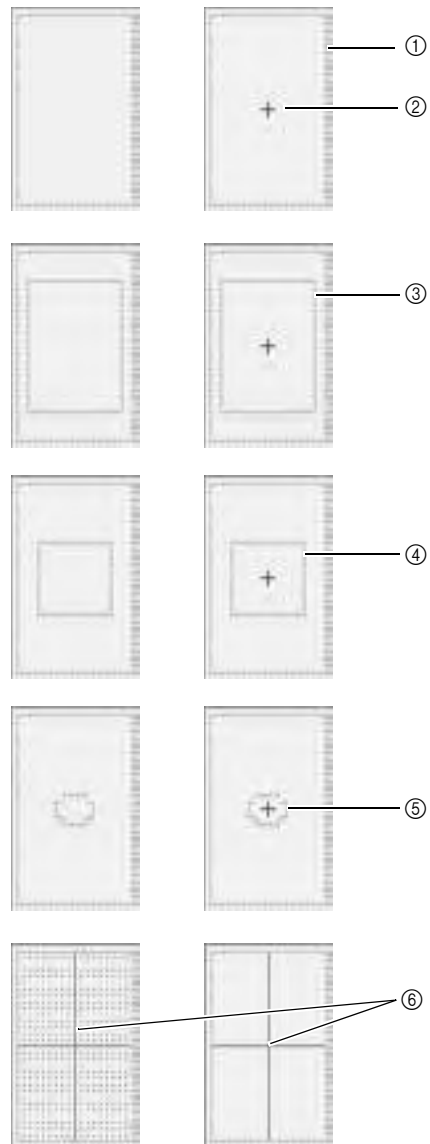
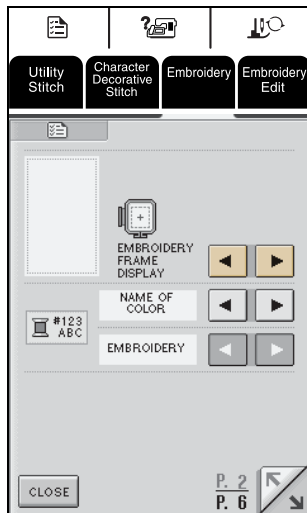

- ① Embroidering area of the extra large frame
- ② Center line
- ③ Embroidering area of the large frame
- ④ Embroidering area of the medium frame
- ⑤ Embroidering area of the small frame (sold separately)
- ⑥ Grid lines

- 3 After selecting the layout, press  .



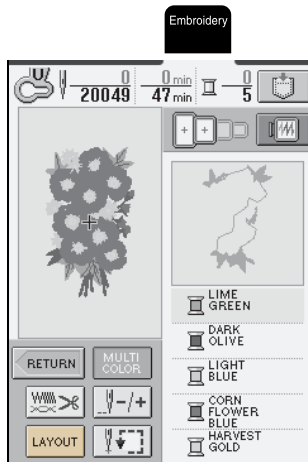

## Changing the Pattern Position

1 Press **LAYOUT**.



2 Press  to move the pattern.

\* Press  to move the pattern in the direction of the arrow on the key.

\* Press  to center the pattern.

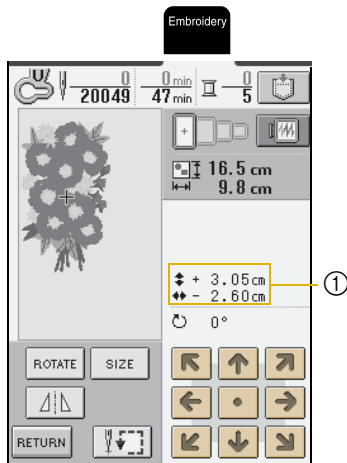

① Distance from the center

3 Press **RETURN**.

→ The sewing screen appears.

## Rotating the Pattern

1 Press **LAYOUT**.

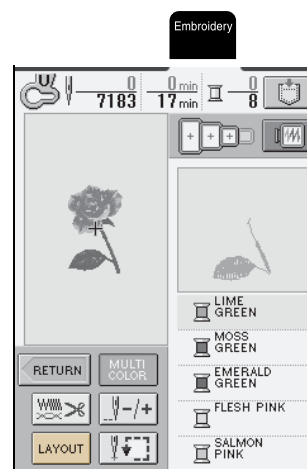

2 Press **ROTATE**.

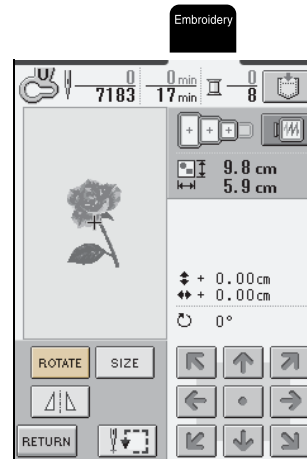

**3** Select the angle that the pattern is rotated.

- \* Press to rotate the pattern 90 degrees to the left.
- \* Press to rotate the pattern 90 degrees to the right.
- \* Press to rotate the pattern 1 degree to the left.
- \* Press to rotate the pattern 1 degree to the right.
- \* Press to return the pattern to its original position.

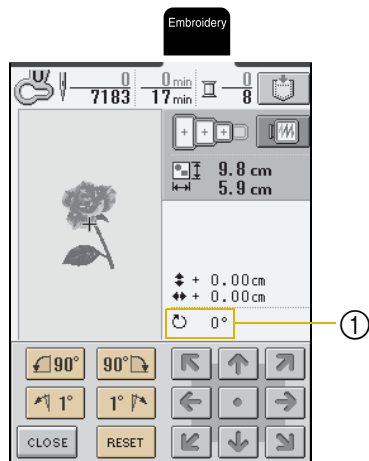

① Degree of rotation

**Note**

- With large patterns that extend out of the extra-large embroidery frame when rotated 90 degrees, each press of or rotates the pattern 180 degrees.
- With large patterns that extend out of the extra-large embroidery frame when rotated at 1 degree increments, each press of or rotates the pattern so that it fits entirely within the embroidery frame.

**4** Press .

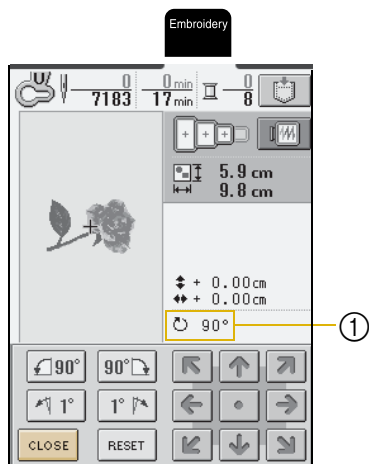

① Degree of rotation

**5** Press .

→ The sewing screen appears.

## Changing the Pattern Size

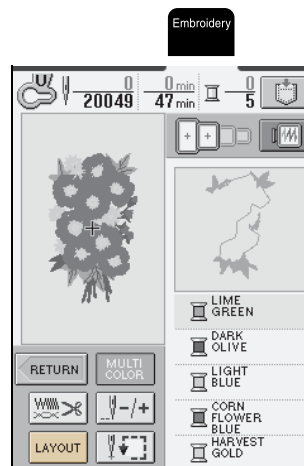

**1** Press .

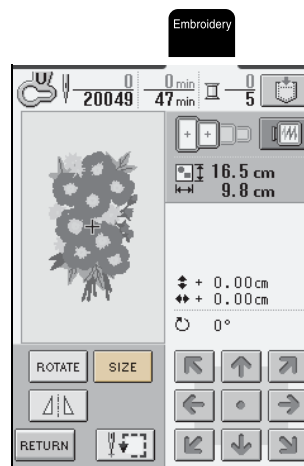

**2** Press .



### 3 Change the size of the pattern.

- \* Press  to reduce the size of the pattern.
- \* Press  to enlarge the size of the pattern.
- \* Press  to return the pattern to its original size.

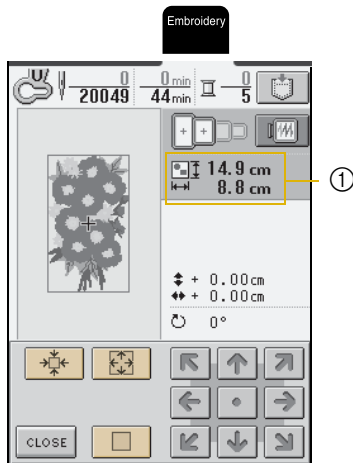

① Size of the pattern



#### Memo

- Some patterns or characters can be enlarged more than others.
- Some patterns or characters can be enlarged to a greater degree if they are rotated 90 degrees.
- Some licence/copyright patterns cannot be enlarged or reduced.

4 Press .

5 Press .

→ The sewing screen appears.

## Creating a Horizontal Mirror Image

1 Press .

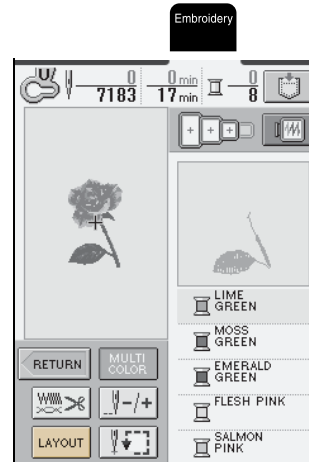

2 Press .

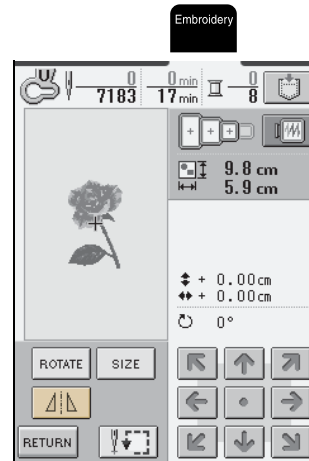

→ The key appears as .



3 Press .

→ The sewing screen appears.



#### Memo

A horizontal mirror image cannot be created from some licensed/copyrighted patterns.



5



Embroidery

## Changing the Stitching Density (Alphabet and Frame Patterns Only)

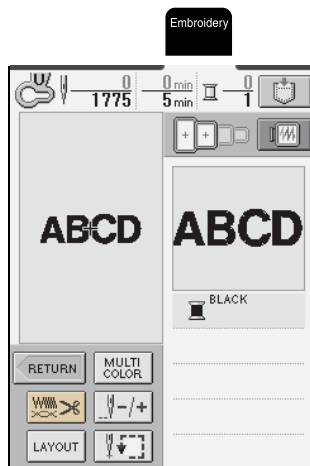
1 Press .



2 Change the stitching density.

- \* Press  to reduce the stitching density.
- \* Press  to increase the stitching density.
- \* Each press of the key changes the stitching density by 5% (The density can be set between 80% and 120%).

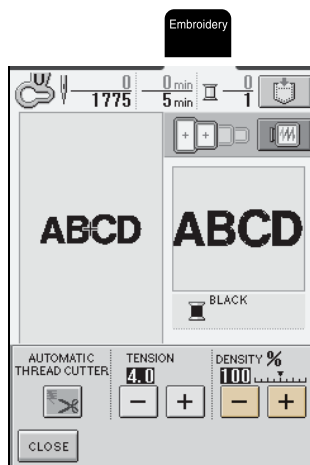

Coarse  
(stitches farther apart)

Standard

Fine  
(stitches closer together)

3 Press .

## Changing the Color of Single Characters

Combined alphabet patterns can be sewn with each letter in a different color. If "MULTI COLOR" is set, the machine stops after each character is sewn so that the thread can be changed to one of a different color.

1 Press .

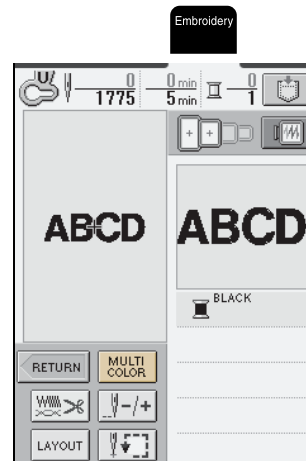

→ The key appears as .

2 After a character is sewn, change the thread color, and then sew the next character.

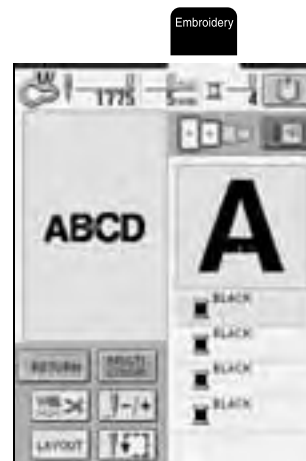



# CHECKING THE PATTERN

## Checking the Embroidering Position

The embroidery frame is moved to indicate the embroidering position. Closely watch the frame to check that the pattern will be sewn at the correct place.

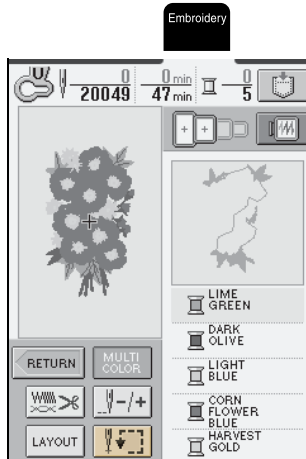
1 Press .



2 Press  to select the position to be checked.

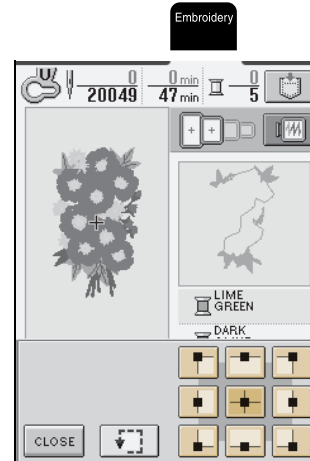

→ The frame moves to indicate the selected position.

### Memo

To view the entire embroidering area, press . The frame moves to indicate the entire embroidering area.

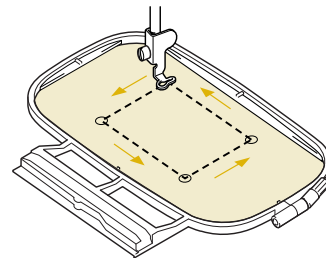

### CAUTION

- Make sure the needle is up when the embroidery frame is moving. If the needle is down, it could break and result in injury.

3 Press .



5

Embroidery

## Previewing the Pattern

1 Press .

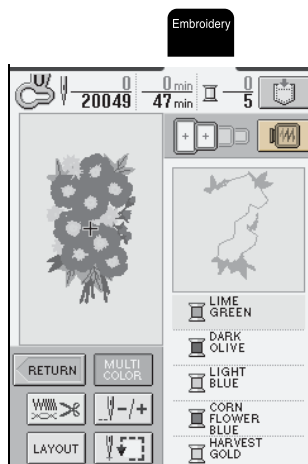

2 Press  to select the frame used in the preview.

\* Embroidery frame icons that appear in light gray cannot be selected.

\* Press  to enlarge the preview of the embroidery pattern.

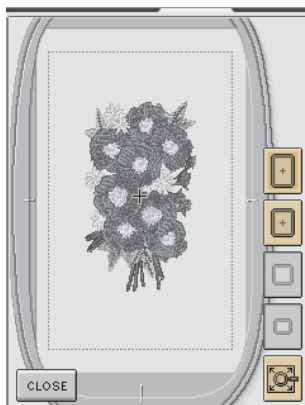

### Memo

- Press the “Start/Stop” button to sew the pattern as it appears in this screen.
- Patterns with many stitches may take some time to preview.

3 Press .

# SEWING AN EMBROIDERING PATTERN

## Sewing Attractive Finishes

There are many factors that go into sewing beautiful embroidery. Using the appropriate stabilizer (see page 129) and hooping the fabric in the frame (see page 130) are two important factors mentioned earlier. Another important point is the appropriateness of the needle and thread being used. See the explanation of threads below.

Thread	Upper thread	Rayon, polyester, or cotton embroidery threads are recommended for use with this machine. Other embroidery threads may not yield optimum results.
	Bobbin thread	Use embroidery bobbin thread intended for use with this machine. When using other kinds of embroidery bobbin thread, follow the instructions below.

### ■ Using Prewound Bobbins with Standard GREEN Marked Bobbin Case

Use the standard GREEN marked bobbin case when embroidering with the recommended bobbin thread wound on included bobbins. When using prewound bobbins (not included with this machine) it is recommended to use prewound COATS "L" type or NEBS clear plastic prewound bobbins with the standard GREEN marked bobbin case.

### ■ Using Prewound Bobbins with Alternate Bobbin Case (no color on the screw)

Use the alternate bobbin case (no color on the screw) when a tighter bobbin tension is needed. For replacing the bobbin case, see page 184.



#### Note

- The bobbin thread sensor does not work when prewound bobbins with a center core are used.
- Due to coating on prewound bobbin thread, the bobbin case may require cleaning occasionally (see page 184).

### ■ Using Bobbin Center Pin (Spacer)

The bobbin center pin (spacer) can be used with either the standard or alternate bobbin cases. Use the bobbin center pin (spacer) for better thread flow, bobbin stability and to provide the correct height for prewound bobbins in the bobbin case.



- 1 Remove the bobbin cover.
- 2 Set the bobbin center pin.

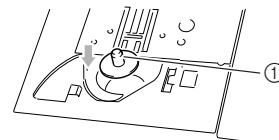

① Bobbin center pin

- 3 Set the prewound bobbin in the same direction as a regular bobbin.
- 4 When using a paper-sided prewound bobbin, remove the side paper on the top side of the prewound bobbin.

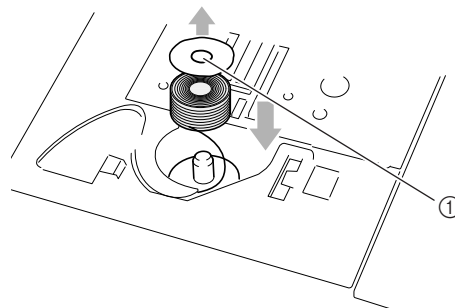

① Top paper



5

Embroidery

**5** Follow steps from “Setting the bobbin” on page 27.



**Memo**

If you use threads other than those listed above, the embroidery may not sew out correctly.



**Note**

- Before embroidering, check that there is enough thread in the bobbin. If you continue sewing without enough thread in the bobbin, the thread may tangle.
- Do not leave objects in the range of motion of the embroidery frame. The frame may strike the object and cause a poor finish to the embroidery pattern.
- When embroidering on large garments (especially jackets or other heavy fabrics), do not let the fabric hang over the table. Otherwise, the embroidery unit cannot move freely, and the pattern may not turn out as planned.

**Embroidery Needle Plate Cover**

Under some conditions, based on the type of fabric, stabilizer, or thread being used, there may be some looping in the upper thread. In this case, attach the included embroidery needle plate cover to the needle plate. Attach the cover by inserting the two projections on the underside of the cover into the notches on the needle plate as shown below.

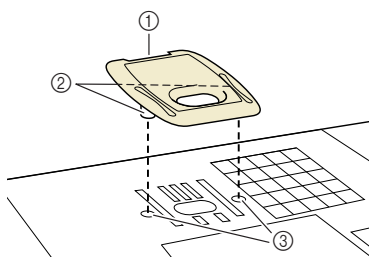

- ① Groove
- ② Projections
- ③ Notches

To remove the embroidery needle plate cover, place your fingernail in the groove and lift the plate out.

**CAUTION**

- Push the embroidery needle plate cover as far as possible to attach it. If the embroidery needle plate cover is not securely attached, it may cause the needle to break.



**Note**

Do not use the embroidery needle plate cover for any applications other than embroidery.

**Sewing Embroidery Patterns**

Example: To embroider

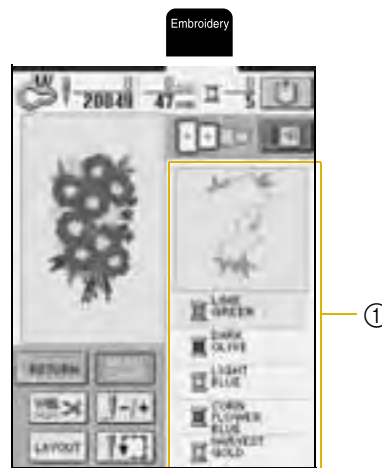

① Embroidery color order

- 1** Thread the machine with thread for the first color, pass the thread through the hole in embroidery foot “U”, pull out some thread to give it some slack, and then lightly hold the end of the thread in your left hand.

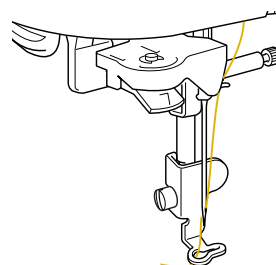

**CAUTION**

- If the thread is too tight, the needle may bend or break.

- 2** Lower the presser foot, and then press the “Start/Stop” button to start embroidering. After 5 or 6 stitches are sewn, press the “Start/Stop” button again to stop the machine.



- 3** Trim off the excess thread at the beginning of the stitching. If the thread is hidden under the presser foot, raise the presser foot, and then cut the thread.

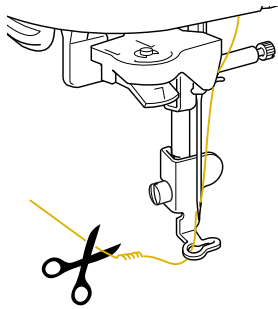

- 4** Press the “Start/Stop” button again to start embroidering.

→ When the area for the first color has been sewn, the machine automatically trims the threads, then stops, and the presser foot is automatically raised. The next color in the embroidery color order moves to the top.

- 5** Remove the thread for the first color from the machine, and then thread the machine with the thread for the second color.

- 6** Repeat these steps to embroider the remaining colors.



→ After the last stitch is sewn, the message “Finished sewing” appears. Press **OK** to return to the previous screen.

\* Depending on the pattern, a more attractive finish can be achieved by trimming the thread jumps after each color is embroidered.

- 7** When the pattern is finished, trim the excess thread jumps (thread linking parts of the pattern, etc.).

## Embroidering Appliqué Patterns

There are some patterns which call for an appliqué inside the pattern.

When sewing an embroidery pattern with an appliqué, the color sewing order display shows “APPLIQUÉ MATERIAL”, “APPLIQUÉ POSITION”, “APPLIQUÉ”, and then the sewing order of the colors around the appliqué.



### Memo

- When “Appliqué Material”, “Appliqué Position” and “Appliqué” are displayed, a specific color does not appear. Use a proper color thread to match the appliqué piece.
- The following design is not preprogrammed in the machine and is used for illustration purposes only.

- 1** Attach iron-on stabilizer to the wrong side of the appliqué fabric.

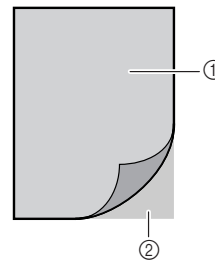

- ① Appliqué fabric (cotton, felt, etc.)  
② Stabilizer

- 2** Hoop the appliqué fabric (from step 1) in the embroidery frame, and then press the “Start/Stop” button to sew material of the appliqué design.

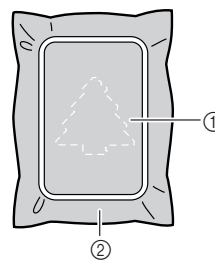

- ① Outline of appliqué  
② Appliqué fabric

→ The machine sews the outline of the appliqué, then stops.



### Memo

The embroidering procedure is the same as the basic procedure described in “Sewing Embroidery Patterns” on page 142.



5

Embroidery

- 3** After sewing is finished, remove the appliqué fabric from the embroidery frame, and then carefully cut along the stitching.



**Note**

Carefully cut out the appliqué along the outline that was sewn. If the appliqué is cut out along the inside of the outline, the appliqué fabric may not be caught by the stitching. If this step is not performed correctly, the appliqué will not be sewn correctly. In addition, carefully remove any excess threads.

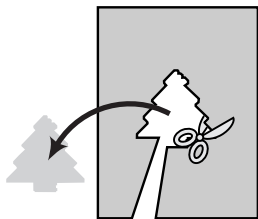

- 4** Hoop the base fabric in the embroidery frame.

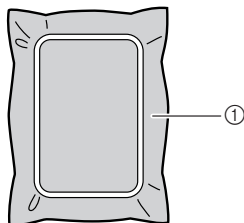

① Base fabric

- 5** Press the “Start/Stop” button to sew the position of the appliqué.

\* Use the same color of thread to be used to attach the appliqué.

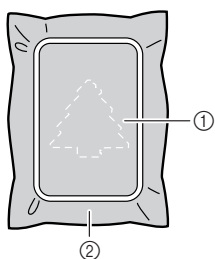

① Appliqué position  
② Base fabric

→ The machine sews around the position of the appliqué, then stops.

- 6** Apply a thin layer of adhesive or spray adhesive to the back of the appliqué piece, and then attach it to the base fabric at the appliqué position sewn in step 5.

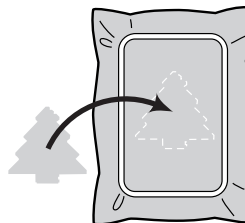

**Note**

If the appliqué fabric is a lightweight fabric, you may want to use a fusible web to stabilize the fabric and to attach it to the base fabric. Do not remove the base fabric from the embroidery frame when ironing on the appliqué piece.

- 7** After the appliqué piece is attached, press the “Start/Stop” button to sew the appliqué.



→ The appliqué is then completed.



**Memo**

Depending on the pattern that is selected, “APPLIQUÉ” may not appear, but instead will appear as a color. If “APPLIQUÉ” appears as a color, embroider using thread of that color.

- 8** Change the upper thread, and then finish embroidering the remainder of the pattern.

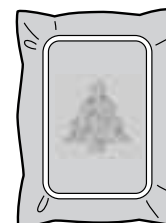



**Note**

- If glue is attached to the presser foot, needle or needle plate, finish embroidering the appliqué pattern, and then clean off the glue.
- For best results, trim all excess threads between pattern parts.

# ADJUSTMENTS DURING THE EMBROIDERY PROCESS

## If the Bobbin Runs Out of Thread

When the bobbin begins to run out of thread during embroidering, the machine will stop and the message below will appear. Press  and follow the directions below to rethread the lower threading. If very little sewing remains, you can sew 10 final stitches without rethreading the machine by pressing . The machine will stop after sewing the 10 stitches.

1 Press .



2 Press .

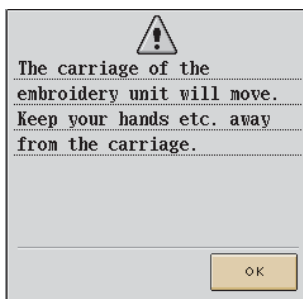

→ The carriage will move and the thread will be automatically cut.

3 Raise the frame-securing lever, and then remove the embroidery frame.

\* Be careful not to apply strong force to the fabric at this time. Otherwise, the fabric may loosen in the frame.

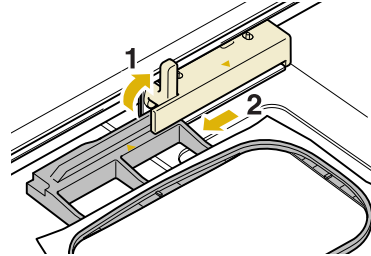

### Note

- Be careful not to apply a strong force to the hooped fabric.
- When removing and reattaching the embroidery frame, do not allow the frame to hit the carriage or the presser foot, otherwise the pattern may become misaligned.

4 Replace the bobbin with a full one.

5 Press .

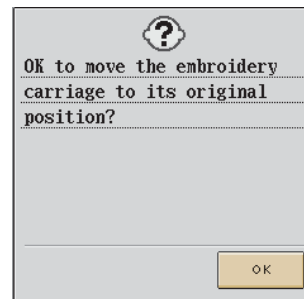

6 Reattach the embroidery frame.

7 To return to the point in the pattern where sewing was stopped, follow steps 3 through 6 in the next section.

### Memo

For best results, return to a point 2 or 3 stitches before sewing stopped.



5

Embroidery

## If the Thread Breaks During Sewing

- 1 Press the “Start/Stop” button to stop the machine.
- 2 If the upper thread broke, rethread the machine. If the bobbin thread broke, follow the instructions in steps 1 through 6 from the previous section to reinstall the bobbin.
- 3 Press .

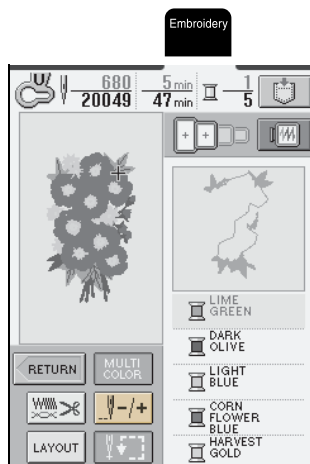

- 4 Press , or to move the needle back 2 or 3 stitches before the point where the thread broke.

\* If you cannot return to the point where the thread broke, press to select a color and return to the beginning of that color. Then, press , or to move forward slightly before the point where the thread broke.

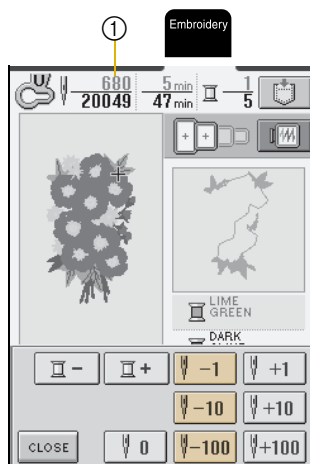

① The number of stitches that have already been sewn.

- 5 Press .

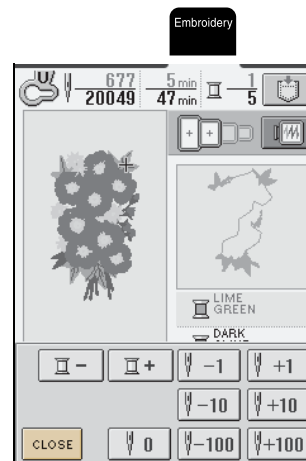

- 6 Press the “Start/Stop” button to continue embroidering.

## Restarting from the Beginning

- 1 Press .

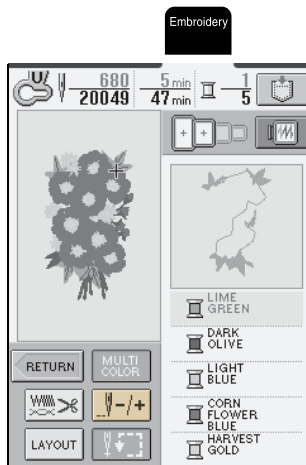

- 2 Press .

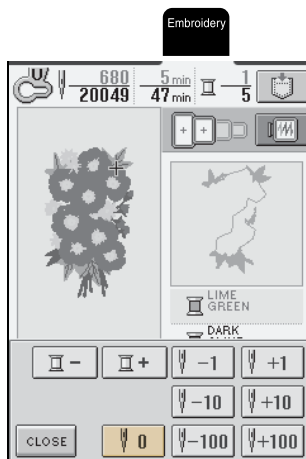

→ The embroidery frame moves, returning the needle to the beginning of the pattern.

- 3 Press .

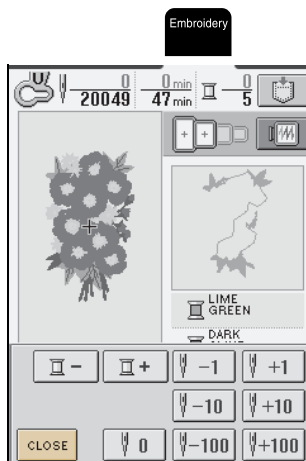

- 4 Press the "Start/Stop" button.

## Automatically Resuming Embroidery When the Power Goes Off

The current color, stitch number and design position are saved when the power is interrupted during embroidering. The next time that the machine is turned on, you can resume embroidering.

### Memo

Even if the power goes out in the middle of embroidery, the machine returns to the point where embroidery was stopped when the machine is turned on again.

### Note

Do not remove the embroidery unit or the memory will no longer remember your design.

- 1 Turn the main power to ON.

- 2 Follow the instructions shown on the screen and remove the embroidery frame.

→ The following message will appear.

- 3 Press .

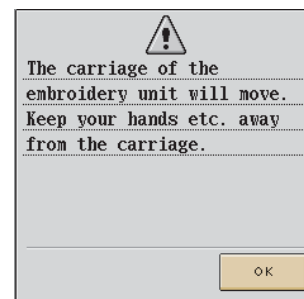

→ The carriage moves to its initial position and the following message will appear.



5

Embroidery

4 Press .

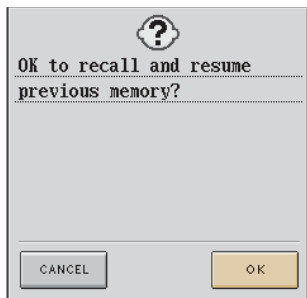

 **Memo**

If you want to start a new operation, press  so the pattern selection screen appears.

→ The confirmation message to lower the frame-securing lever appears.

5 Reattach the embroidery frame.

→ The previous sewing screen displayed before the machine was turned off appears.

6 Press the “Presser Foot Lifter” button to lower the presser foot, and press the “Start/Stop” button to continue embroidering.





① Stitch number when embroidery is resumed

## Manually Resuming Embroidery After Turning Off the Power

**Example:** If the power is turned off while sewing the second color

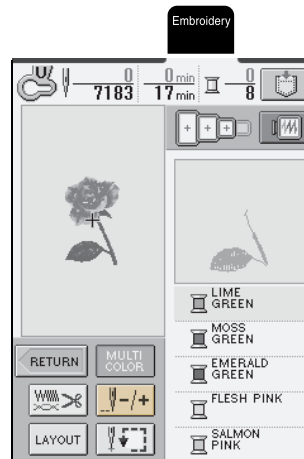
1 Select the pattern and press .



2 Press  to move the second color to the first position in the display.

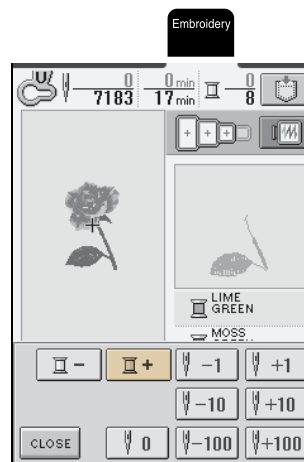

- 3 Use **+1**, **+10**, or **+100** to advance the pattern to slightly before where sewing stopped.



- 4 Press **CLOSE** to return to the original screen.
- 5 Press the "Presser Foot Lifter" button to lower the presser foot and press the "Start/Stop" button to start sewing.

**Note**

To continue a pattern that has had its position changed (see page 135), move the pattern the same amount in the layout display screen, then follow the steps above. In this case, you need to make a note of the pattern's position before turning off the power.

**Memo**

Use the **7183** display to remember the last stitch number sewn before you turn off the power. Then use the **+1**, **+10**, or **+100** keys to move the pattern to the same stitch number and continue sewing.

## Adjusting the Thread Tension

When embroidering, the thread tension should be set so that the upper thread can be slightly visible from the wrong side of the fabric. With some fabric and thread combinations, the thread tension may need to be adjusted.

### ■ Correct Thread Tension

The upper thread can be slightly visible from the wrong side of the fabric. If the thread tension is not set correctly, the stitching may be uneven, there may be puckering in the fabric, or the thread may break.



Right side of fabric



Wrong side of fabric

Follow the procedures described below to adjust the thread tension according to the current condition.

**Note**

If the thread tension is set so that it is extremely weak, the machine may stop during sewing. This is not a sign of a malfunction. Slightly increase the thread tension to begin sewing again.

**Memo**

- If the machine is turned off or a different pattern is selected, the thread tension setting returns to its default.
- When a saved pattern is retrieved, the thread tension setting changes to that set when the pattern was saved.
- If the upper thread is not threaded correctly or the bobbin is not set correctly, it may not be possible to set the correct thread tension. If the correct thread tension cannot be achieved, rethread the upper thread or reset the bobbin.



5

Embroidery

**■ If the Upper Thread Is Too Tight**

The upper thread is too tight when the bobbin thread is visible from the right side of the fabric.



Right side of fabric



Wrong side of fabric

1 Press .

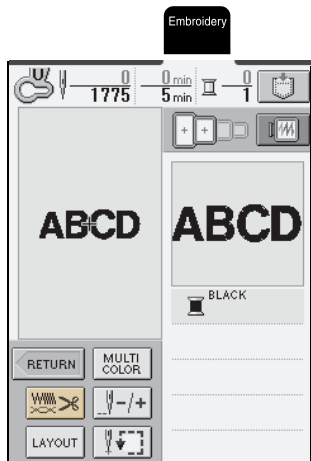

2 Press  in the tension display.

\* Each press of the key decreases the value and weakens the upper thread tension.

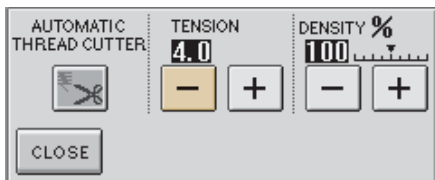

3 Press .

**■ If the Upper Thread Is Too Loose**

The upper thread is too loose when there are loose thread locks or when loops appear on the right side of the fabric.



Right side of fabric



Wrong side of fabric

1 Press .

2 Press  in the tension display.

\* Each press of the key increases the value and tightens the upper thread tension.

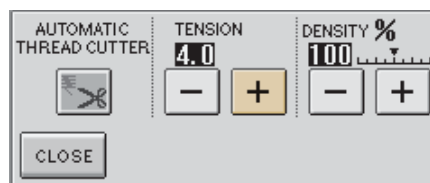

3 Press .

**Automatic Thread Cutting (End Color Trim)**

If the automatic thread cutting setting is selected, the machine will automatically cut the thread at the end of each color step sewn. To cancel the setting, press



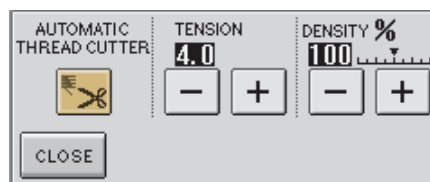

, and then press  again so that it appears as





## Changing the Embroidering Speed

- 1 Press .
- 2 Press  or  in the “MAX EMBROIDERY SPEED” display on P. 3 of the screen.

\* You can choose from 3 embroidering speed levels.



### Memo

- SPM is the number of stitches sewn in one minute.
- Decrease the sewing speed when embroidering on thin, thick, or heavy fabrics.
- The sewing speed can be changed while embroidery is being sewn.
- The maximum sewing speed setting does not change until a new setting is selected. The setting specified before the machine is turned off remains selected the next time that the machine is turned on.
- Decrease the sewing speed to 600 spm when using a specialty thread like a metallic thread.

- 3 Press .

## Changing the Thread Color Display

From the following, select the thread color that appears in the embroidery color order display. You can change the thread color display on embroidery screen to the thread color name, the time to embroider each step or the thread brand number.



### THREAD COLOR NAME

NAME OF COLOR 

### TIME

TIME 

### THREAD NUMBER

# 123 

EMBROIDERY/POLYESTER  
THREAD#

COUNTRY/COTTON THREAD#

MADEIRA POLY THREAD#

MADEIRA RAYON THREAD#

SULKY POLY THREAD#

ROBISON-ANTON POLY  
THREAD#





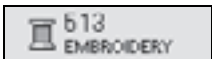









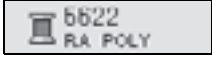







5

Embroidery



**Example:** Displaying the thread number of “EMBROIDERY”

**1** Press  .

**2** Press  or  beside  on P. 2 of the screen to select the “#123”.



→ “EMBROIDERY” appears at the bottom.

**3** Press   to select the thread brand.

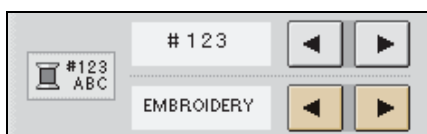

**4** Press  .

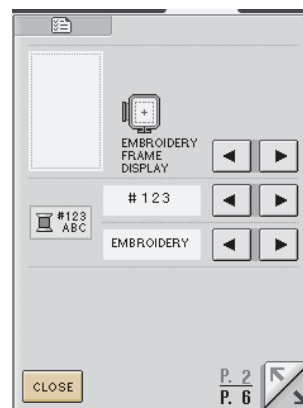

→ The thread color display is changed.



**Memo**

Colors on the screen may vary slightly from actual spool colors.

# USING THE MEMORY FUNCTION

## Embroidery Data Precautions

Observe the following precautions when using embroidery data other than that created and saved in this machine.

### CAUTION

- When using embroidery data other than our original patterns, the thread or needle may break when sewing with a stitch density that is too fine or when sewing three or more overlapping stitches. In that case, use one of our original data design systems to edit the embroidery data.

### ■ Types of Embroidery Data that can be Used

- Only .pes, .phc, and .dst embroidery data files can be used with this machine. Using data other than that saved using our data design systems or sewing machines may cause the embroidery machine to malfunction.

### ■ Types of USB Devices/Media that can be Used

Stitch data can be saved to or recalled from USB media. Use media that meets the following specifications.

- USB Floppy disk drive
- USB Flash drive (USB Flash memory).
- USB CD-ROM, CD-R, CD-RW drives (recalling only)



#### Memo

Stitch/embroidery data cannot be saved using a USB CD-ROM, CD-R or CD-RW drive.

You can also use the following types of USB media with the USB Memory Card Reader/Writer.

- Secure Digital (SD) Card
- CompactFlash
- Memory Stick
- Smart Media
- Multi Media Card (MMC)
- XD-Picture Card



#### Note

- Some USB media may not be usable with this machine. Please visit our web site for more details.
- USB hubs cannot be used with this machine. The machine will not recognize the above USB devices or USB memory cards through a USB hub.
- The access lamp will begin blinking after inserting USB Devices/Media, and it will take about 5 to 6 seconds to recognize the Devices/Media. (Time will differ depending on the USB Device/Media).



#### Memo

- When a file folder is necessary to create, use a computer.
- Letters and numerals can be used in the file names. In addition, if the file name contains no more than eight characters, the entire file name will appear on the screen.  
If the file name is more than eight characters long, only the first six characters followed by “~” and a number appear as the file name.



## ■ Computers and Operating Systems with the Following Specifications can be Used

- Compatible models:  
IBM PC with a USB port as standard equipment  
IBM PC-compatible computer equipped with a USB port as standard equipment
- Compatible operating systems:  
Microsoft Windows Me/2000/XP  
(Windows 98SE requires a driver. Download the driver from our web site ([www.babylock.com](http://www.babylock.com))).

## ■ Precautions on Using the Computer to Create and Save Data

- If the name of the embroidery data file/folder cannot be identified, for example, because the name contains special characters, the file/folder is not displayed. If this occurs, change the name of the file/folder. We recommend using the 26 letters of the alphabet (uppercase and lowercase), the numbers 0 through 9, “-”, and “\_”.
- If .pes embroidery data larger than 26 cm (H) × 16 cm (W) (approx.10-1/4 inches (H) × 6-1/4 inches (W)) is selected, a message appears asking if you wish to rotate the pattern 90 degrees. Embroidery data larger than 26 cm (H) × 16 cm (W) (approx.10-1/4 inches (H) × 6-1/4 inches (W)), even after being rotated 90 degrees, cannot be used (All designs must be within the 26 cm (H) × 16 cm (W) (approx.10-1/4 inches (H) × 6-1/4 inches (W)) design field size.)
- .pes files saved with the number of stitches, the number of colors and the number of combined patterns exceeding the specified limits cannot be displayed. Use one of our original data design systems to edit the embroidery pattern so that it meets the specifications.
- Embroidery data stored in a folder created in USB media can be retrieved.
- Do not create folders in “Removable Disk” on a computer. If embroidery data is stored in a folder in “Removable Disk”, that embroidery data cannot be retrieved by the machine.
- Even if the embroidery unit is not attached, the machine will manage embroidery data.

## ■ Tajima (.dst) Embroidery Data

- .dst data is displayed in the pattern list screen by file name (the actual image cannot be displayed). Only the first eight characters of the file name can be displayed.
- Since Tajima (.dst) data does not contain specific thread color information, it is displayed with our default thread color sequence. Check the preview and change the thread colors as desired.

## ■ Trademarks

- Secure Digital (SD) Card is a registered trademark or a trademark of SD Card Association.
- CompactFlash is a registered trademark or a trademark of Sandisk Corporation.
- Memory Stick is a registered trademark or a trademark of Sony Corporation.
- Smart Media is a registered trademark or a trademark of Toshiba Corporation.
- Multi Media Card (MMC) is a registered trademark or a trademark of Infineon Technologies AG.
- xD-Picture Card is a registered trademark or a trademark of Fuji Photo Film Co. Ltd.
- IBM is a registered trademark or a trademark of International Business Machines Corporation.
- Microsoft and Windows are registered trademarks or trademarks of Microsoft Corporation.

Each company whose software title is mentioned in this manual has a Software License Agreement specific to its proprietary programs.

All other brands and product names mentioned in this manual are registered trademarks of their respective companies. However, the explanations for markings such as ® and ™ are not clearly described within the text.

## Saving Embroidery Patterns in the Machine's Memory

You can save embroidery patterns that you have customized and will use often, for example, your name or other pattern combinations, patterns that have been rotated or resized, or patterns that have had their embroidering position changed.



### Note

Do not turn off the machine while the "Saving" screen is displayed, otherwise you may lose the pattern that you are saving.



### Memo

- It takes a few seconds to save a pattern in the machine's memory.
- See page 158 for information on retrieving a saved pattern.

- 1 With the pattern that you want to save displayed in the sewing screen, press .

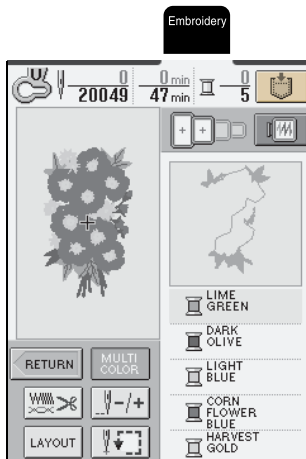

- 2 Press .

\* Press to return to the previous screen without saving the pattern.

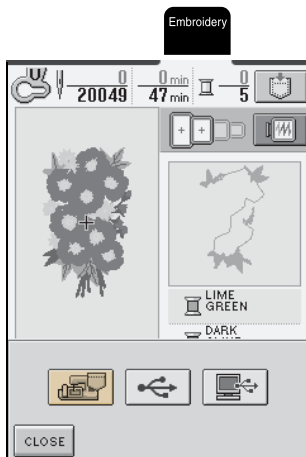

→ The "Saving" screen appears. When the pattern is saved, the previous screen appears automatically.

## ■ If the Memory Is Full

If the following screen appears, either the maximum number of patterns have been saved or the pattern that you want to save takes a lot of memory, and the machine cannot save it. To save the pattern in the machine's memory, you have to delete a previously saved pattern.

- 1 Press .

\* Press to return to the previous screen without saving the pattern.

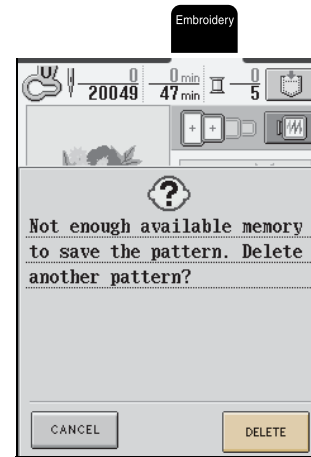

- 2 Select a pattern to be deleted.

\* Press if you do not want to delete the pattern.

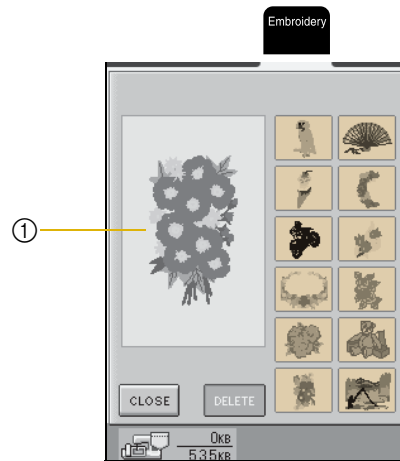

- ① A pattern that you want to save



5

Embroidery

3 Press **DELETE**.

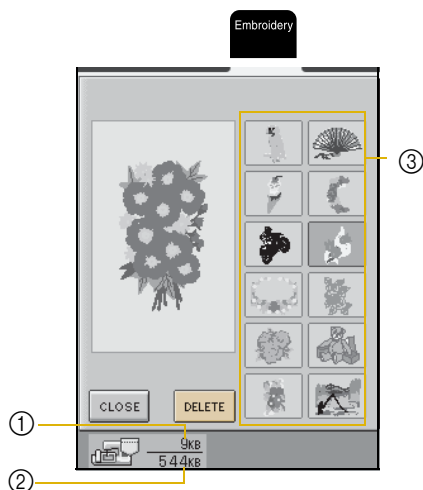

- ① Amount of memory used by the pattern to be deleted
- ② Total amount of machine memory available for saving patterns
- ③ Pattern keys holding saved embroidery patterns

4 Press **OK**.

\* If you decide not to delete the pattern, press **CANCEL**.

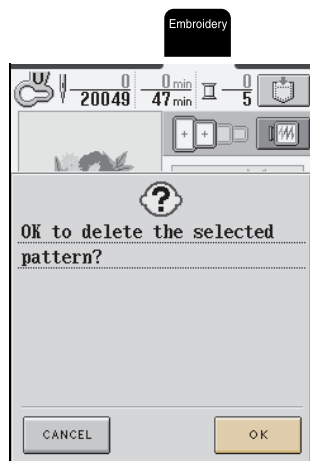

→ The "Saving" screen appears. When the pattern is saved, the previous screen appears automatically.

**Memo**

- If there is enough memory available after deleting the pattern, the pattern that you want to save will be saved automatically. If there is not enough memory available after deleting the pattern, repeat the above procedure to delete another pattern from the machine's memory.
- It takes a few seconds to save a pattern in the machine's memory.
- See page 158 for more information about retrieving saved patterns.

## Saving Embroidery Patterns to USB Media (Commercially Available)

When sending embroidery patterns from the machine to USB media, plug the USB media into the machine's USB port. Depending on the type of USB media being used, either directly plug the USB device into the machine's USB port or plug the USB Card Reader/Writer into the machine's USB port.



**Memo**

Some USB media may not be usable with this machine. Please visit our web site for more details.

1 Press **SAVE** when the pattern you want to save is in the sewing screen.



2 Insert the USB media into the USB port connector on the machine.

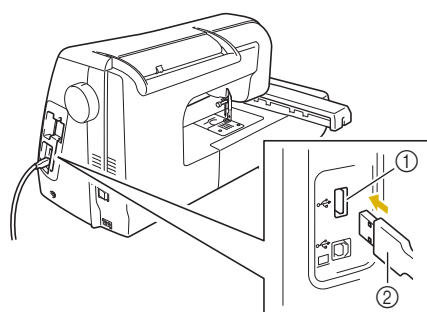

- ① USB port connector for media
- ② USB media



**Memo**

Do not insert anything other than USB media into the USB media port connector. Otherwise, the USB media drive may be damaged.

3 Press .

\* Press **CLOSE** to return to the original screen without saving.

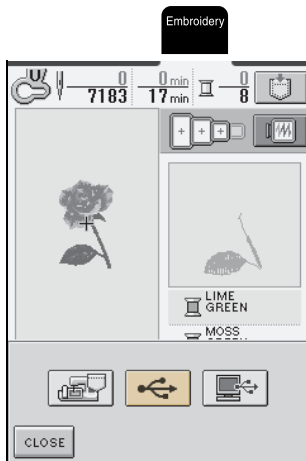

→ The "Saving" screen is displayed. When the pattern is saved, the display returns to the original screen automatically.

**Note**  
Do not unplug the USB media or eject the floppy disk while the "Saving" screen is displayed, otherwise the USB media may be damaged or data may be lost.

## Saving Embroidery Patterns to the Computer

Using the included USB cable, connect the sewing machine to your computer so that embroidery patterns can be retrieved from and saved to your computer.

**Note**  
Do not turn off the machine while the "Saving" screen is displayed, otherwise you may lose the pattern that you are saving.

1 Plug the USB cable connectors into the corresponding USB port connectors on the computer and on the machine.

\* The USB cable can be plugged into the USB port connectors on the computer and machine whether or not they are turned on.

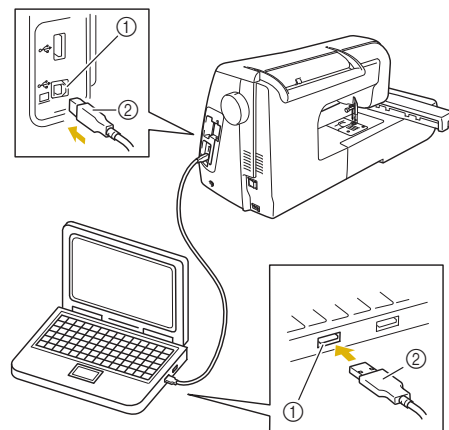

- ① USB port connector for computer
- ② USB cable connector

→ The "Removable Disk" icon appears in "My Computer" on the computer.

**Note**

- The connectors on the USB cable can only be inserted into a port in one direction. If it is difficult to insert the connector, do not insert it with force, and then check the orientation of the connector.
- For details on the position of the USB port connector on the computer (or USB hub), refer to the instruction manual for the corresponding equipment.

- 2** With the pattern that you want to save displayed in the sewing screen, press .

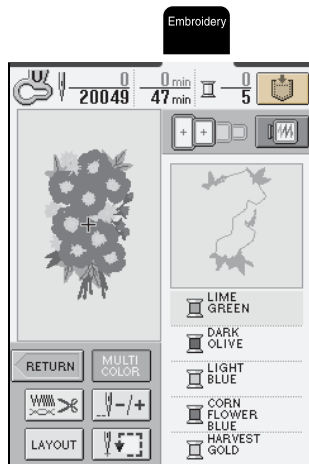

- 3** Press .

\* Press **CLOSE** to return to the previous screen without saving the pattern.

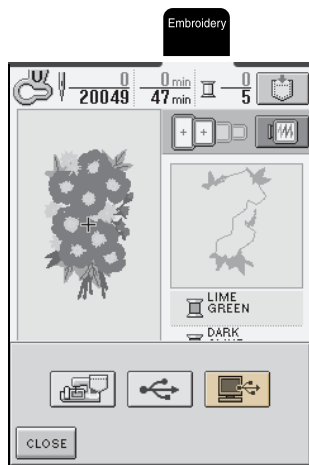

→ The pattern is temporarily saved to "Removable Disk" under "My Computer".

- 4** Select the pattern's .phc file in "Removable Disk", and copy the file to the computer.



## Retrieving Embroidery Patterns from the Machine's Memory

- 1** Press .

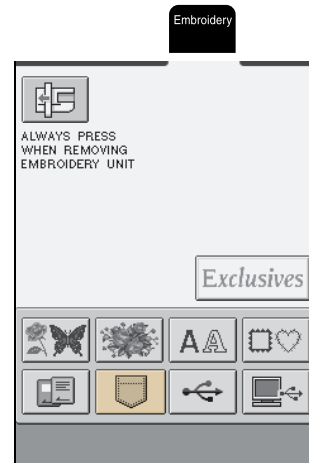

→ The pocket selection screen appears.

- 2** Select a pattern to be retrieved.

\* If you decide not to retrieve the pattern, press



①

- ① Total amount of machine memory available for saving patterns



3 Press **SEWING**.

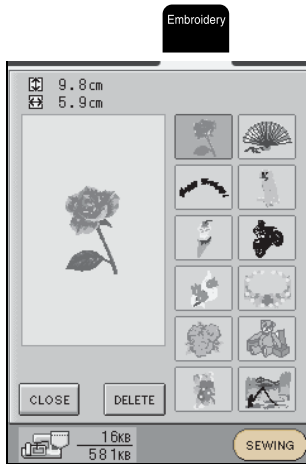

→ The sewing screen appears.

## Retrieving Embroidery Patterns from USB Media (Commercially Available)

You can retrieve a specific embroidery pattern from either directly USB media or a folder in the USB media. If the embroidery pattern is under the folder, move down layers of folders following a path to it.

1 Insert the USB media into the USB port connector on the machine (see page 156).

2 Press **USB**.



### Memo

Some USB media may not be usable with this machine. Please visit our web site for more details.

3 Press the key of the pattern you want to retrieve.

\* Press **CLOSE** to return to the original screen.

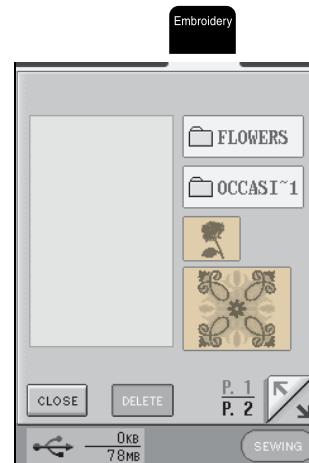

4 Press **SEWING**.

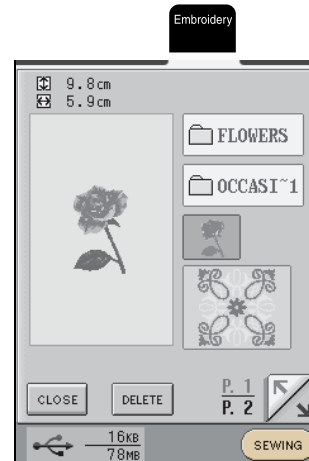

→ The sewing screen is displayed.

### Note

Do not unplug the USB media or eject the floppy disk or CD while a stitch pattern is being read or deleted, otherwise the USB media may be damaged or data may be lost. In addition, do not unplug the USB media or eject the floppy disk or CD while the contents of the USB media, floppy disk or CD are displayed.

## Retrieving Embroidery Patterns from the Computer

- 1 Plug the USB cable connectors into the corresponding USB port connectors on the computer and on the machine (see page 157).
- 2 The "Removable Disk" icon appears in "My Computer" on the computer.



- 3 Copy the pattern data to "Removable Disk".



→ Pattern data in "Removable Disk" is written to the machine.

### Note

- While data is being written, do not disconnect the USB cable.
- Do not create folders within "Removable Disk". Since folders are not displayed, pattern data within folders cannot be retrieved.
- While the machine is sewing, do not write data to or delete data from "Removable Disk".

- 4 Press  .



→ The pattern selection screen appears.

- 5 Select an embroidery pattern to be retrieved.

\* If you decide not to retrieve the pattern, press

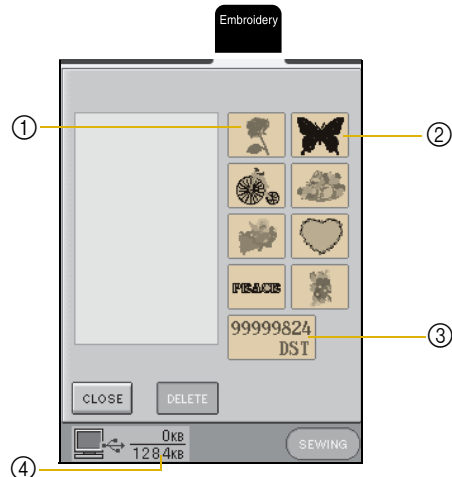

- ① PHC data
- ② PES data
- ③ DST data
- ④ Total amount of "Removable Disk" memory available for saving patterns

6 Press **SEWING**.

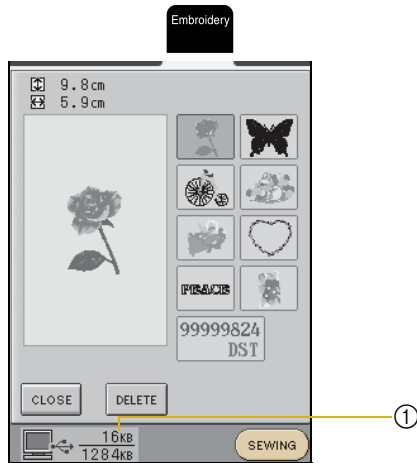

① Amount of memory used by the selected pattern

→ The sewing screen appears.

**CAUTION**

- When disconnecting the USB cable:  
Before disconnecting the USB cable, click the “Unplug or Eject Hardware” icon in the taskbar of Windows® Me/2000 or the “Safely Remove Hardware” icon in the taskbar of Windows® XP. Then, when the removable disk has been removed safely, disconnect the USB cable from the computer and the machine.



With Windows 98SE, check that the Access lamp is not flashing before disconnecting the USB cable from the computer and the machine.

**Note**

- Be sure to perform the operation described above before disconnecting the USB cable from the computer and the machine, otherwise the computer may malfunction, the data may not be written correctly, or the data or data writing area on the machine may be damaged.
- The pattern retrieved from the computer is only temporarily written to the machine. It is erased from the machine when the machine is turned off. If you wish to keep the pattern, store it in the machine (see “Saving Embroidery Patterns in the Machine’s Memory” on page 155).

# EMBROIDERY APPLICATIONS

## Using a Frame Pattern to Make an Appliqué (1)

You can use frame patterns of the same size and shape to create an appliqué. Embroider one pattern with a straight stitch and the other pattern with a satin stitch.

- 1 Select a straight stitch frame pattern, embroider the pattern onto the appliqué fabric, and then neatly cut around the outside of the stitching.

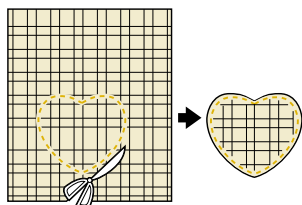
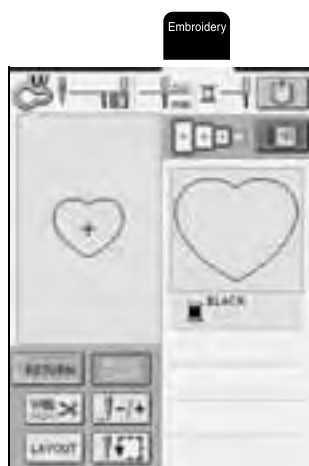

- 2 Embroider the same pattern on the base fabric.

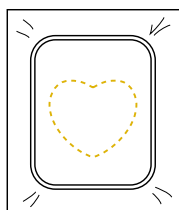

- 3 Apply a thin layer of fabric glue or temporary spray adhesive to the back of the appliqué piece cut out in step 1, and then attach the appliqué to the base fabric within the outline.

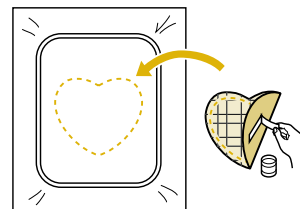

- 4 Select the satin stitch frame pattern of the same shape, and then embroider over the appliqué and base fabric from step 3.



### Note

If the size or embroidering position of the straight stitch frame pattern was changed, be sure to change the size or embroidering position of the satin stitch frame pattern in the same way.

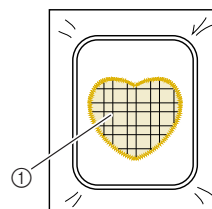

① Appliqué fabric

## Using a Frame Pattern to Make an Appliqué (2)

This is a second method for making appliqués using embroidery patterns. With this method, there is no need to change the fabric in the embroidery frame. To make the appliqué, embroider one pattern with a straight stitch and the other pattern with a satin stitch.

- 1 Select a straight stitch frame pattern, and then embroider the pattern onto the base fabric.



- 2 Place the appliqué fabric over the pattern embroidered in step 1. Make sure that the appliqué fabric completely covers the stitching.

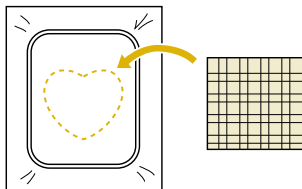

- 3 Embroider the same pattern on the appliqué fabric.

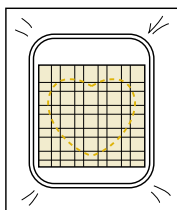

- 4 Remove the embroidery frame from the machine, and then cut around the outside of the stitching.

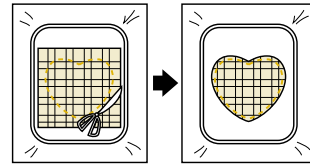

### Note

Leave the fabric in the embroidery frame when cutting off the excess appliqué fabric. In addition, do not apply extreme pressure to the framed fabric, otherwise the fabric could become loose.

- 5 Select the satin stitch frame pattern of the same shape as the appliqué.



### Note

Do not change the size or embroidering position of the pattern.

- 6 Attach the embroidery frame removed in step 4, and then embroider the pattern.

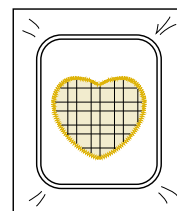

5

Embroidery





# Chapter 6

## Embroidery Edit

<b>AVAILABLE EDITING FUNCTIONS.....</b>	<b>166</b>
■ Combined Patterns .....	166
■ Move Patterns .....	166
■ Rotate Patterns .....	166
■ Enlarge or Reduce Patterns.....	166
■ Create Mirror Images .....	166
■ Change Character Spacing .....	166
■ Change Character Appearance/Layout.....	166
<b>SELECTING PATTERNS TO EDIT .....</b>	<b>167</b>
Selecting Embroidery Patterns/Floral Patterns/Frame Patterns/Baby Lock Exclusive Embroidery Designs .....	167
Alphabet Patterns.....	168
<b>EDITING PATTERNS.....</b>	<b>170</b>
■ Key Functions.....	170
Moving the Pattern.....	171
Rotating the Pattern .....	171
Changing the Size of the Pattern .....	172
Deleting the Pattern .....	173
Changing the Configuration of Character Patterns.....	173
Changing the Character Spacing .....	174
Changing the Color of Each Character in a Pattern.....	174
Changing the Thread Color .....	174
Creating a Custom Thread Table .....	176
■ Adding a Color to the Custom Thread Table from the List .....	177
Choosing a Color from the Custom Thread Table .....	177
After Editing .....	178
<b>COMBINING PATTERNS.....</b>	<b>179</b>
Editing Combined Patterns .....	179
Sewing Combined Patterns.....	182
<b>USING THE MEMORY FUNCTION.....</b>	<b>182</b>

## AVAILABLE EDITING FUNCTIONS

With the Embroidery Edit functions, you can change the size of patterns, rotate patterns, adjust the character spacing and layout, and perform many other editing operations. In addition, characters and patterns can be combined and rearranged within the 26 cm × 16 cm (approx. 10 - 1/4 inches × 6 - 1/4 inches) embroidering area. With the Embroidery Edit functions, you can combine various patterns and characters to create original patches and embroidery.

### ■ Combined Patterns

You can easily create combinations of embroidery patterns, frame patterns, character patterns, and patterns from separately sold embroidery cards.

### ■ Move Patterns

Within the 26 cm × 16 cm (approx. 10 - 1/4 inches × 6 - 1/4 inches) embroidery area, you can change the position of patterns, and check their position on the LCD.

### ■ Rotate Patterns

You can rotate patterns one degree, 10 degrees or 90 degrees at a time.

### ■ Enlarge or Reduce Patterns

You can make patterns larger or smaller.

- This function is not available with some patterns.

### ■ Create Mirror Images

You can create horizontal mirror images of patterns.

- This function is not available with some patterns.

### ■ Change Character Spacing

You can increase or decrease the spacing between characters in combined patterns.

### ■ Change Character Appearance/Layout

You can change the layout of the characters to a curved line, a diagonal line, or any of the 6 choices available.





# SELECTING PATTERNS TO EDIT

Attach the embroidery unit, prepare the machine for embroidering according to the instructions on page 120, and then press  to display the screen shown below.

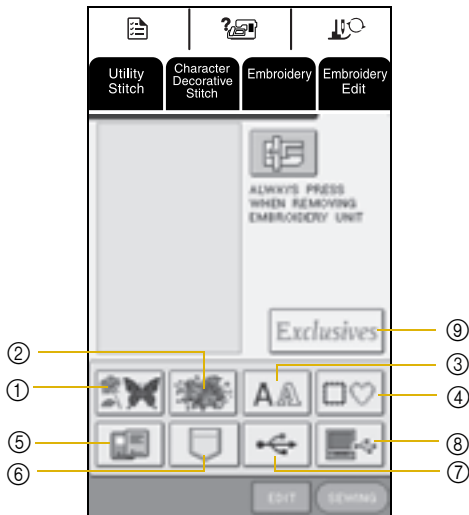

- ① Embroidery patterns
- ② Floral patterns
- ③ Alphabet patterns
- ④ Frame patterns
- ⑤ Embroidery cards (sold separately)
- ⑥ Patterns saved in the machine's memory (see page 158).
- ⑦ Patterns saved in USB media (see page 159).
- ⑧ Patterns saved on the computer (see page 160).
- ⑨ Baby Lock Exclusive Embroidery Designs



### Memo

For details on the pattern selection screen, see page 124 or the "Quick Reference Guide".

## Selecting Embroidery Patterns/Floral Patterns/Frame Patterns/Baby Lock Exclusive Embroidery Designs

- 1 Select the category of the pattern.



- 2 Select an embroidery pattern.

\* For details on selecting patterns, see page 125 and page 126.

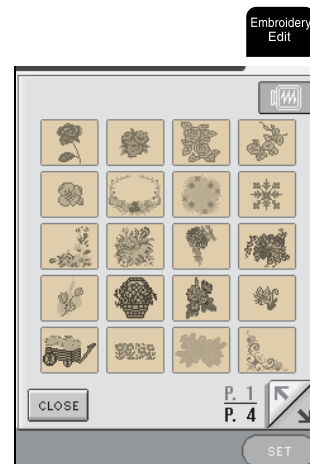

→ The selected pattern is highlighted.



6

Embroidery Edit

3 Press **SET**.

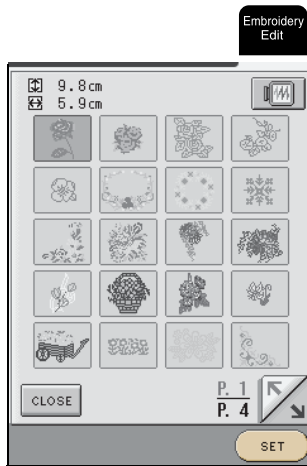

→ The selected pattern appears in the screen.

4 Continue with "EDITING PATTERNS" on page 170.



## Alphabet Patterns

With the Embroidery Edit functions, you can edit the appearance of a character at the same time that you enter it.

1 Press **AA**.



2 Select the character style, and then enter the characters.

- \* For details on selecting characters, see page 125.
- \* Press **AA** to view an image of all entered characters.

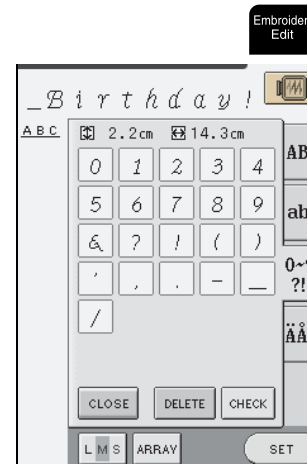

- 3 Press **ARRAY** to change the layout of the pattern.



① Layout of characters



**Memo**

The layout of the characters appears in the upper-left corner of the screen.

- 4 Select the layout.



→ The displayed character layout changes.

- 5 Press **CLOSE** to return to the previous screen.

- 6 Press **SET**.



→ The embroidery edit screen appears.

- 7 Continue with "EDITING PATTERNS" on page 170.



6

Embroidery Edit

# EDITING PATTERNS

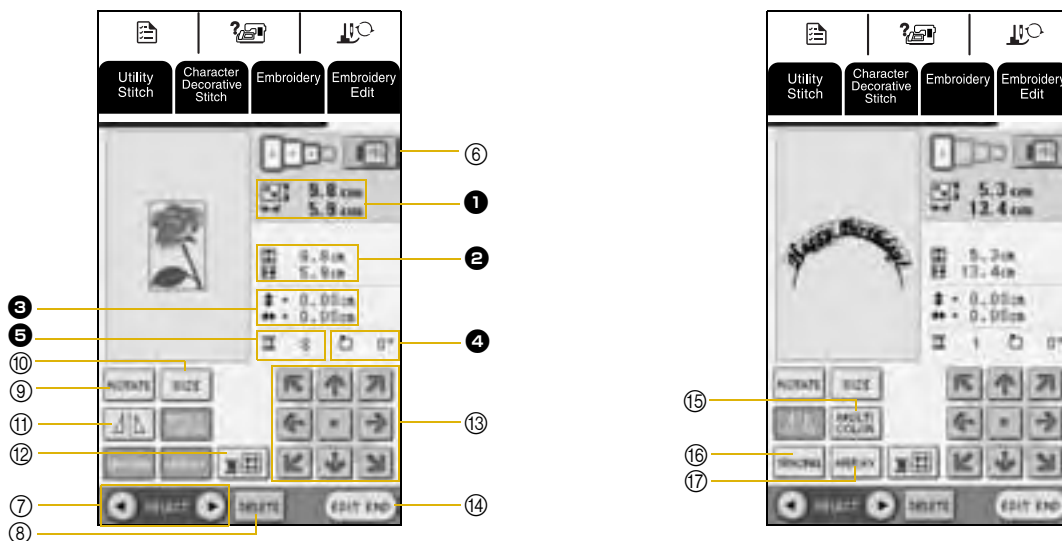

- ① Shows the size of the entire combined pattern.
- ② Shows the size of the pattern currently selected.
- ③ Shows the distance from the center of frame.
- ④ Shows the degree of rotation for the selected pattern.
- ⑤ Shows the number of colors in the selected design.

## ■ Key Functions

No.	Key	Name	Function	Page
⑥		Image key	Press this key to display a preview of the embroidery pattern.	140
⑦		Pattern selection key	Press this key to select the pattern to be edited when multiple patterns have been combined.	173
⑧		Delete key	Press this key to delete the selected pattern (pattern outlined by the red box).	173
⑨		Rotate key	Press this key to rotate the pattern. You can rotate the pattern one degree, 10 degrees or 90 degrees at a time.	171
⑩		Size key	Press this key to change the size of the pattern. Patterns can be enlarged or reduced.	172
⑪		Horizontal mirror image key	Press this key to create a horizontal mirror image of the selected pattern.	137
⑫		Thread palette key	Press this key to change the colors of the displayed patterns.	174,177
⑬		Arrow keys (● Center key)	Press these keys to move the pattern in the direction indicated by the arrow on the key.	171
⑭		Edit end key	Press this key to continue to the next step.	178
⑮		Multi color key	Press this key to change the color of individual characters in a pattern. Press  to embroider each character in a different color.	174
⑯		Spacing key	Press this key to change the spacing of character patterns.	174
⑰		Array key	Press this key to change the configuration of a character pattern.	173



### Memo

Depending on the pattern that is selected, some editing functions may not be available. Keys that appear in light gray are not available.

## Moving the Pattern

Press  to move the pattern in the direction

shown on the key.

Press  to center the pattern.

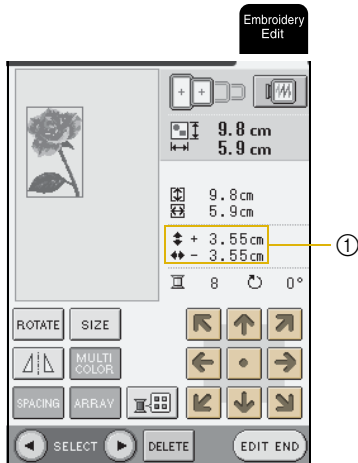





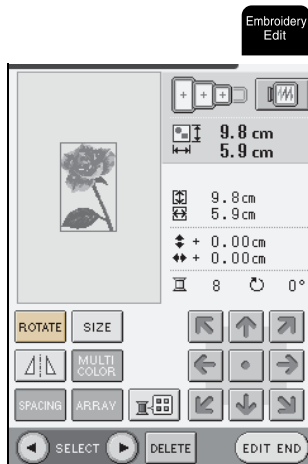

① Distance from the center

## Rotating the Pattern

1 Press .







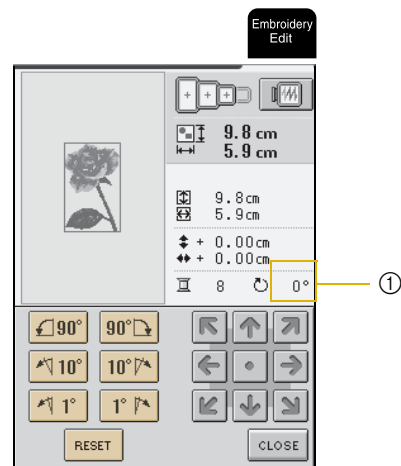

2 Select the angle that the pattern is rotated.

- \* Press  to rotate the pattern 90 degrees to the left.
- \* Press  to rotate the pattern 90 degrees to the right.
- \* Press  to rotate the pattern 10 degrees to the left.
- \* Press  to rotate the pattern 10 degrees to the right.
- \* Press  to rotate the pattern 1 degree to the left.
- \* Press  to rotate the pattern 1 degree to the right.
- \* Press  to return the pattern to its original position.



① Degree of rotation

### Note

- With large patterns that extend out of the extra-large embroidery frame when rotated 90 degrees, each press of  or  rotates the pattern 180 degrees.
- With large patterns that extend out of the extra-large embroidery frame when rotated 10 degrees, each press of  or  rotates the pattern so that it fits entirely within the embroidery frame.
- With large patterns that extend out of the extra-large embroidery frame when rotated at 1 degree increments, each press of  or  rotates the pattern so that it fits entirely within the embroidery frame.



6

Embroidery Edit

3 Press **CLOSE**.

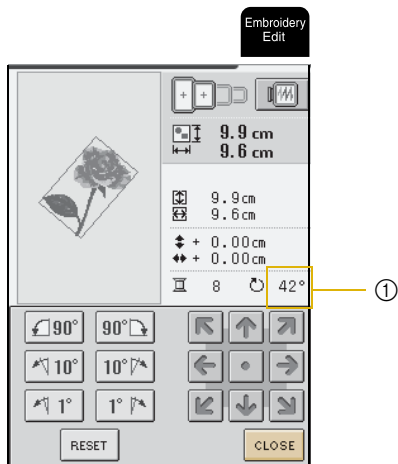





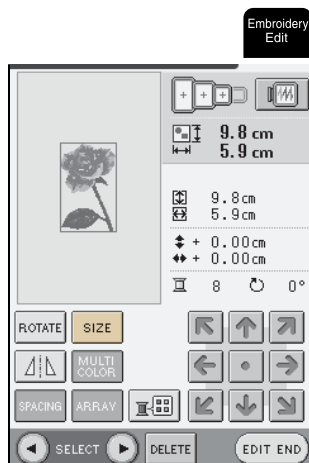

① Degree of rotation

## Changing the Size of the Pattern

1 Press **SIZE**.



2 Select the direction in which the size is changed.

- \* Press  to reduce the pattern proportionately.
- \* Press  to enlarge the pattern proportionately.
- \* Press  to reduce the pattern vertically.
- \* Press  to enlarge the pattern vertically.
- \* Press  to reduce the pattern horizontally.
- \* Press  to enlarge the pattern horizontally.
- \* Press  to return the pattern to its original size.

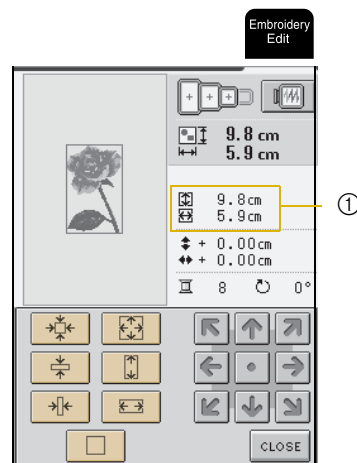

① Size of the pattern

### Memo

- Some patterns or characters can be enlarged more than others.
- Some patterns or characters can be enlarged to a greater degree if they are rotated 90 degrees.
- Some licence/copyright patterns cannot be enlarged or reduced.

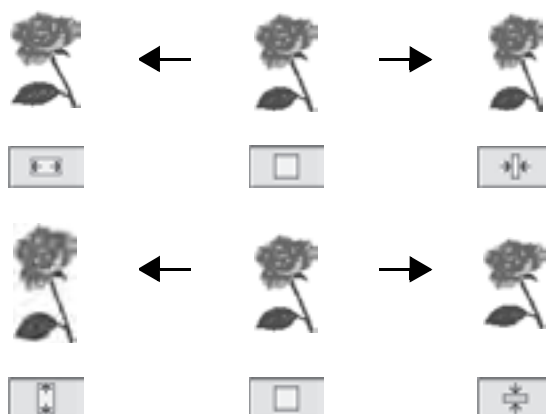

3 Press **CLOSE** .

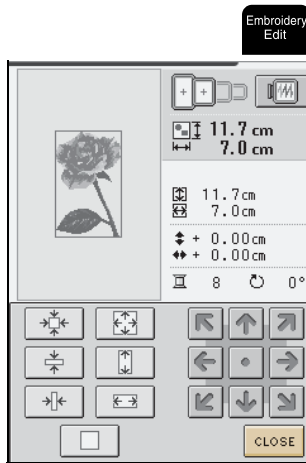

## Deleting the Pattern

Press **SELECT** to select the pattern to be deleted.

Continue touching **SELECT** until the red frame encloses the pattern you wish to delete. Then press

**DELETE** .

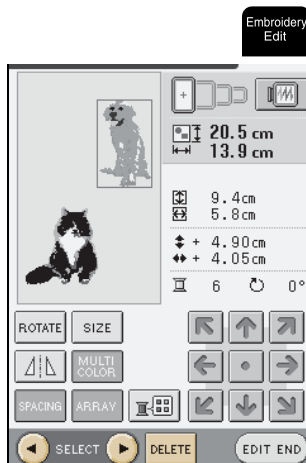



## Changing the Configuration of Character Patterns

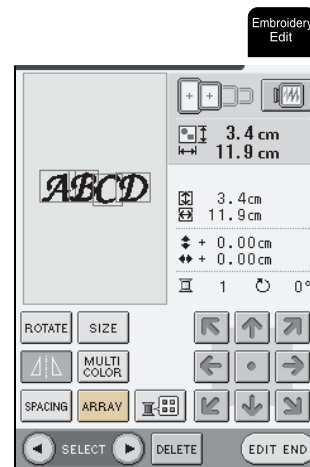



1 Press **ARRAY** .



2 Select the layout.

- \* After selecting an arc layout, press  to expand the arc.
- \* After selecting an arc layout, press  to reduce the arc.

### Memo

When selecting ,  and  change to  and  . You can increase or decrease the incline.

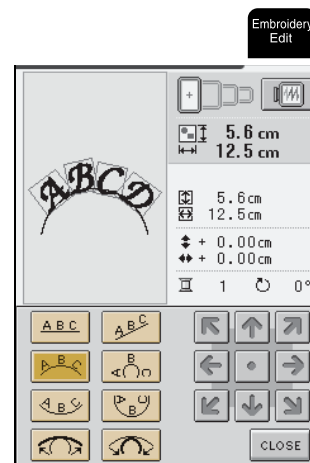

3 Press  to adjust the position.

- \* Press  to center the pattern.

4 Press **CLOSE** .



6

Embroidery Edit

## Changing the Character Spacing

1 Press **SPACING**.

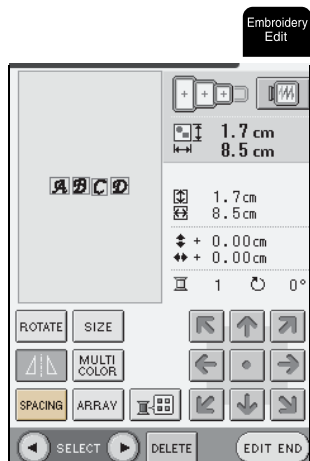

2 Press **+A.B.C+** or **-A.B.C-**.

- \* Press **+A.B.C+** to widen the character spacing.
- \* Press **-A.B.C-** to tighten the character spacing.
- \* Press **A.B.C** to return the pattern to its original spacing.

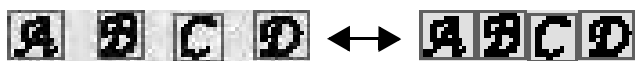
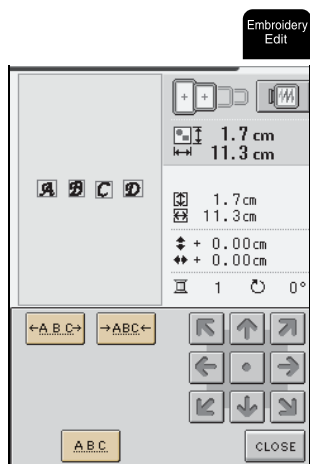

3 Press **←**, **→**, **↑**, or **↓** to adjust the position.

- \* Press **○** to center the pattern.

4 Press **CLOSE**.

## Changing the Color of Each Character in a Pattern

Press **MULTI COLOR** so that it appears as **MULTI COLOR**. The machine will stop after each character is embroidered so the thread can be changed.

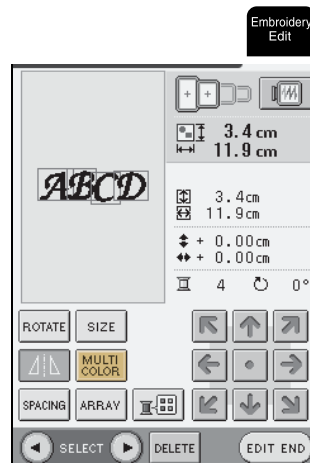

### Memo

The multi color settings can also be set from the sewing screen. For details, see page 138.

## Changing the Thread Color

You can change the thread color by moving the color to be changed to the top of the sewing order and selecting a new color from the 64 thread colors from 6 brands in the machine.

1 Press **☐**.

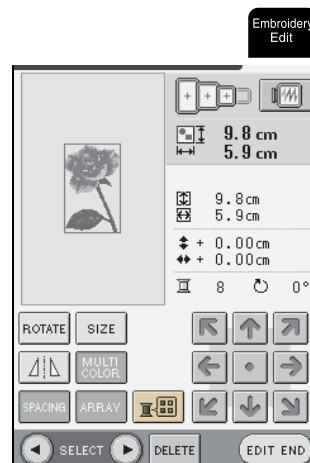

→ The thread color palette screen displays.



- 2 If necessary, press to change the thread color display (see “Changing the Thread Color Display” on page 151).

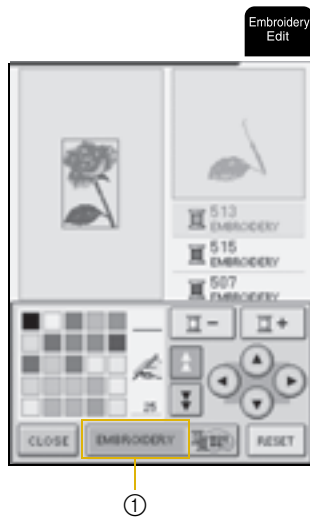

- ① Thread color display  
→ The thread color display changes to name of color.

- 3 Press or to put the color you want to change at the top of the sewing order.

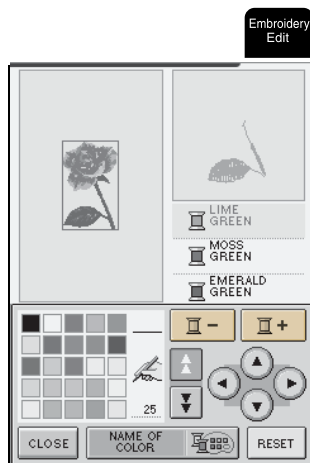

- 4 Press color palette or .

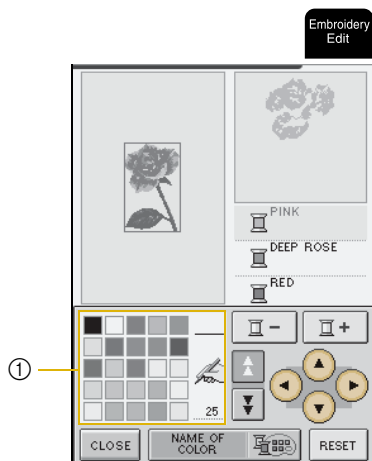

- ① Color palette  
→ A cursor appears on the color palette.

- 5 Press to choose a new color from the color palette.

- \* You can scroll through 25 colors at a time using and .
- \* To return to the original color, press . If multiple colors have been changed, this command will return all colors to their original colors.
- \* You can select colors from the color palette by directly touching the color palette with the touch pen.

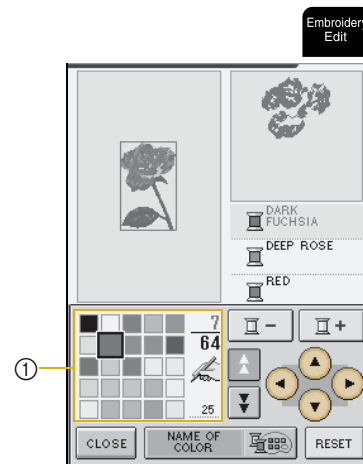

- ① Color palette  
→ The selected color appears at the top of the sewing order.

- 6 Press .

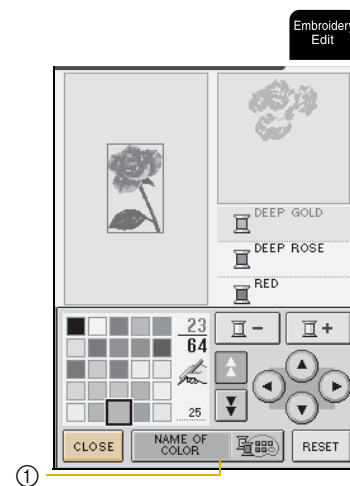

- ① Color palette/Custom thread table change key  
→ The display shows the changed colors.



### Memo

To select a color from the Custom Thread Table, see “Choosing a Color from the Custom Thread Table” on page 177.



6

Embroidery Edit

## Creating a Custom Thread Table

You can create a custom thread table containing the thread colors that you most often use. You can select thread colors from the machine's extensive list of thread colors from five different thread brands. You can select any color and move the color to your custom thread table.



### Note

You can download the data or the 300 color custom thread table. Visit our web site of "http://www.babylock.com"

1 Press , and then press to display P. 5.

2 Use to select where to add a color on the custom thread table.

\* You can also touch the palette directly with the touch pen.

\* You can scroll through 25 colors at a time using and .

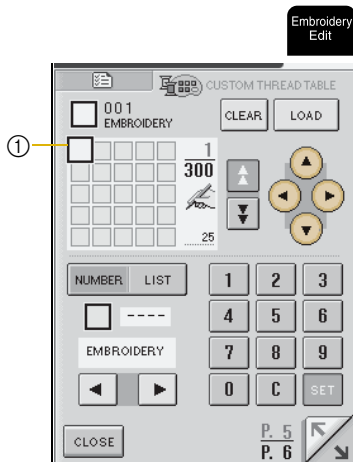

① Custom thread table



### Memo

is pressed to download future color data. For information, visit the web site.

3 Use to select one of the thread brands in the machine.

4 Use to enter a color's 4-digit number.

\* If you make a mistake, press to erase the entered number, and then enter the correct number.

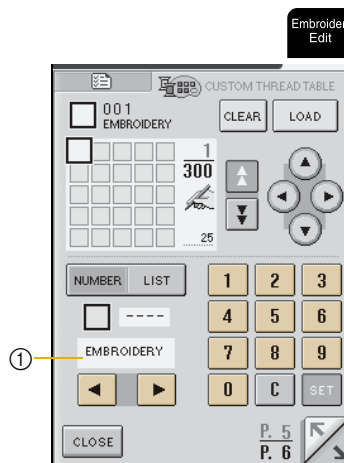

① Thread brand

5 Press .

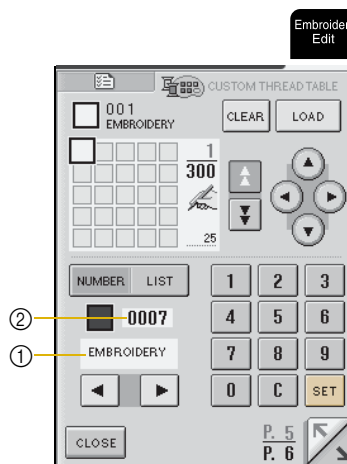

① Thread brand  
② Entered number

→ The selected thread color is set in the custom thread table.



### Note

- If is not pressed, the thread color number will not be changed.

6 Repeat the previous steps until all desired thread colors are specified.

\* To delete a specified color from the palette, select the color and press .

- 7 Press **CLOSE** to return to the original screen.



■ Adding a Color to the Custom Thread Table from the List

- 1 Repeat the previous steps 1 through 3.
- 2 Press **NUMBER LIST** to display the thread list.
- 3 Use **▲ ▼** to select a thread color.

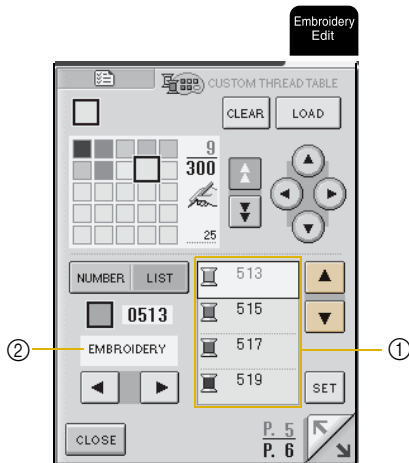

- ① Thread list
- ② Thread brand

- 4 Press **SET**.
- 5 Repeat the previous steps until all desired thread colors are specified.

\* To delete a specified color from the palette, press



## Choosing a Color from the Custom Thread Table

You can select a color from the up to 300 thread colors you have set in the custom thread table.

- 1 Press .

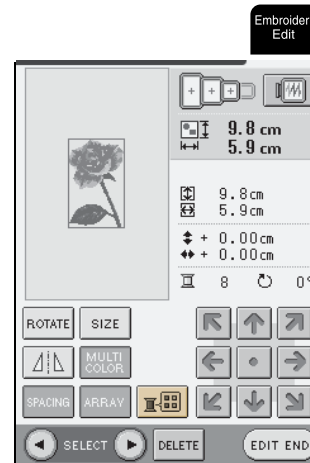

→ The thread color palette screen displays.

- 2 Press **+** or **-** to put the color you want to change at the top of the sewing order.

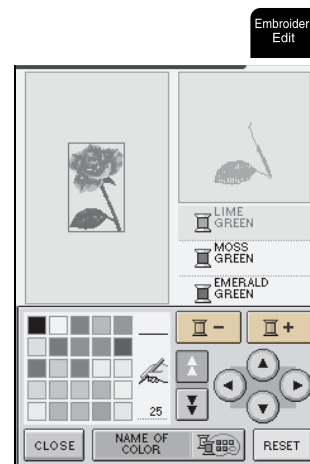

6

Embroidery Edit

3 Press **NAME OF COLOR**.

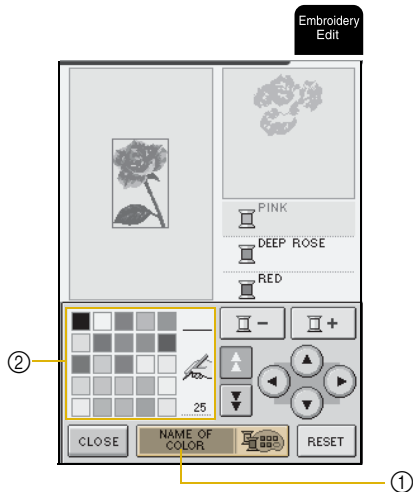

- ① Color palette/Custom thread change key
- ② Color palette

→ The custom thread table will appear.

4 Press **▲**, **▶**, **▶**, **▼** to choose a new color from the custom thread table.

- \* Use **▲** and **▼** to scroll through the custom thread table.
- \* Press **RESET** to return to the original color.
- \* You can select colors from the custom thread table by directly touching the color palette with the touch pen.

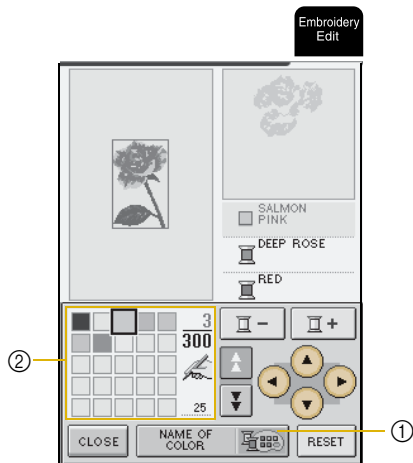

- ① Custom thread
  - ② Custom thread table
- The display shows the changed colors.

5 Press **CLOSE**.

## After Editing

1 Press **EDIT END**.

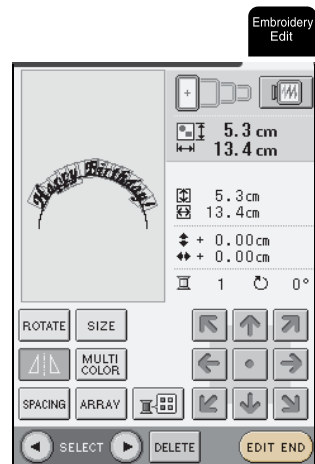

2 Press **SEWING** to embroider the edited pattern.

- \* Press **EDIT** to return to the embroidery edit screen.

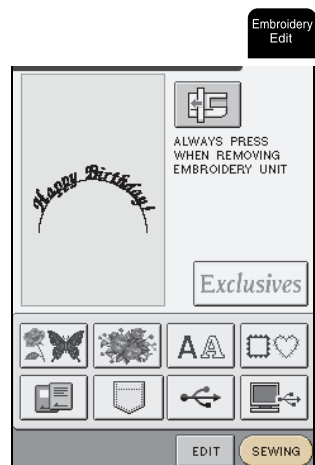

**Memo**  
For details on combining patterns, see page 179.

# COMBINING PATTERNS

This section will describe how to combine characters and embroidery patterns.

## Editing Combined Patterns



1 Press  .



2 Press  on P. 1 of the screen.



3 Press  .

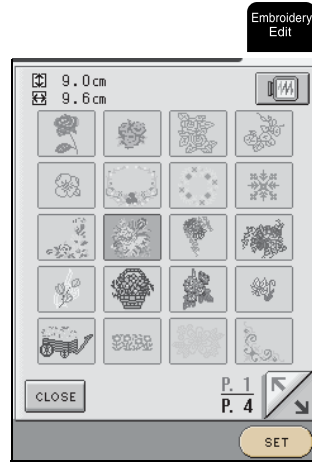

4 Press  .

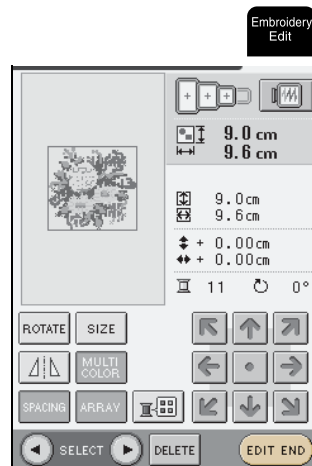

Embroidery Edit

5 Press **AA**.



6 Press **ABC**.

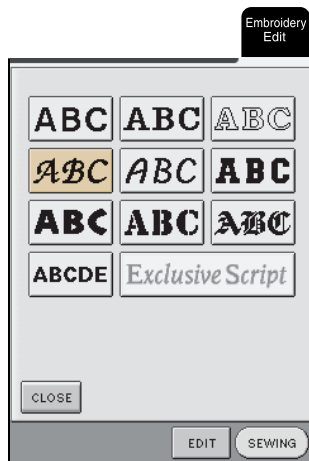

7 Enter "WELCOME".

- \* For details on selecting characters, see page 125.
- \* After entering "W", press **LMS** to change the size to M, then enter the remaining characters.
- \* Press **W** to view an image of all entered characters.

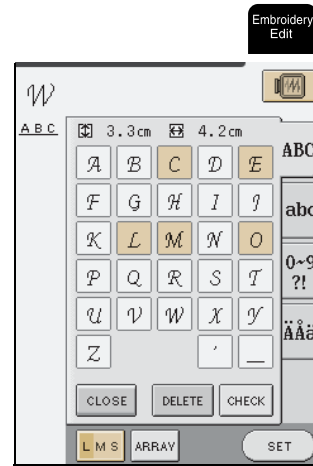



8 Press **SET**.

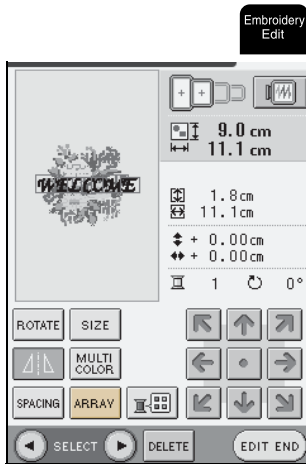

9 Press **ARRAY** to change the layout of the characters.

\* For details, see page 173.



10 Press  to adjust the position of the characters.

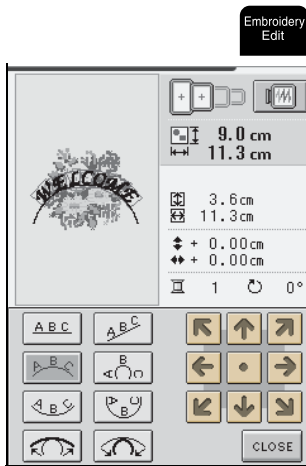

11 Press **CLOSE**.

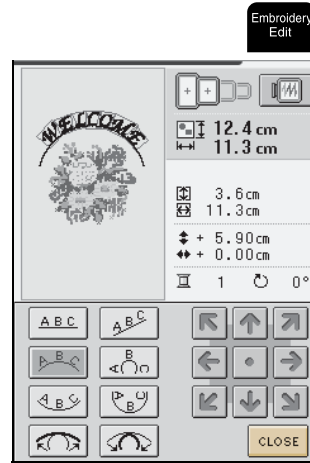

12 Press **EDIT END**.

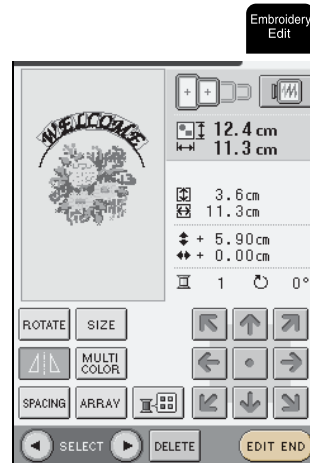

## Sewing Combined Patterns

Combined patterns will be embroidered in the order that they were entered. In this example, the embroider order will be as follows. For details, see “Sewing Embroidery Patterns” on page 142.

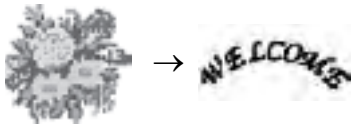

1 Press **SEWING**.



2 Embroider  according to the color order on the right side of the screen.



3 Embroider .



→ When “WELCOME” is completed, the message “Finished sewing” appears.

Press **OK** to return to the previous screen.

## USING THE MEMORY FUNCTION

In the same way that embroidery patterns are saved and retrieved in chapter 5, you can save edited embroidery patterns to the machine’s memory and retrieve them later. In addition, these edited embroidery patterns can be saved to a computer, and embroidery patterns created and edited using other data design systems can be retrieved from the computer.

For details on saving and retrieving embroidery patterns, see “USING THE MEMORY FUNCTION” on page 153.





# Chapter 7

## Appendix

<b>CARE AND MAINTENANCE</b> .....	<b>184</b>
Cleaning the LCD .....	184
Cleaning the Machine Casing .....	184
Cleaning the Race .....	184
Cleaning the Bobbin Case .....	185
<b>ADJUSTING THE SCREEN</b> .....	<b>186</b>
Screen Visibility Is Low .....	186
Touch Panel Is Malfunctioning.....	186
<b>TROUBLESHOOTING</b> .....	<b>188</b>
<b>ERROR MESSAGES</b> .....	<b>191</b>
■ Alarm .....	196
<b>SPECIFICATIONS</b> .....	<b>197</b>
<b>UPGRADING YOUR MACHINE'S SOFTWARE</b> .....	<b>198</b>
Upgrade Procedure Using USB Media .....	198
Upgrade Procedure Using Computer .....	199

# CARE AND MAINTENANCE

## ⚠ CAUTION

- Be sure to unplug the machine before cleaning it. Otherwise, electric shock or injury may result.

### Cleaning the LCD

If the surface of the LCD is dirty, lightly wipe it with a soft dry cloth. Do not use organic solvents or detergents.

### Cleaning the Machine Casing

If the surface of the machine is dirty, dampen a cloth with a neutral detergent, wring it out firmly, and then wipe the surface. Then, wipe again with a dry cloth.

### Cleaning the Race

If dust or dirt collects in the race or bobbin case, the machine will not run well, and the bobbin thread detection function may not operate. Keep the machine clean for best results.

- 1 Press the "Needle Position" button to raise the needle.
- 2 Lower the presser foot.
- 3 Turn off the machine.
- 4 Remove the needle (see page 35) and the presser foot holder (see page 68).
- 5 Remove the flat bed attachment or the embroidery unit if either is attached.
- 6 Grasp both sides of the needle plate cover, and then slide it toward you.

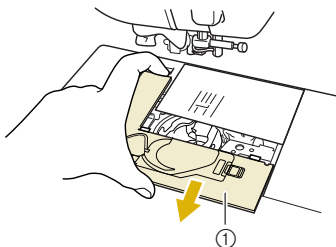

① Needle plate cover

- 7 Grasp the bobbin case, and then pull it out.

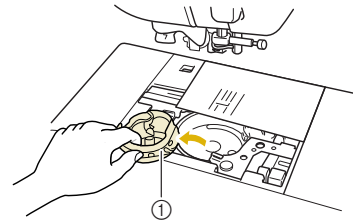

① Bobbin case

- 8 Use the included cleaning brush or a vacuum cleaner to remove any lint and dust from the race and its surrounding area.

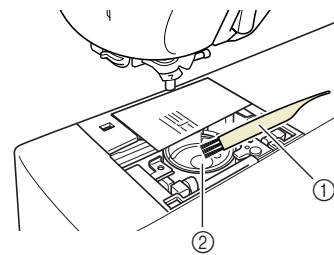

① Cleaning brush  
② Race



#### Note

Do not apply oil to the race.

- 9** Insert the bobbin case so that the projection on the bobbin case aligns with the spring.

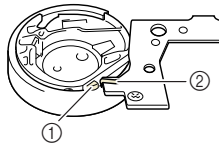
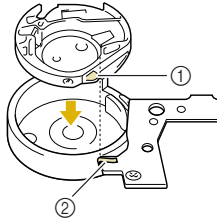

- ① Projection  
② Spring

- 10** Insert the tabs on the needle plate cover into the needle plate, and then slide the cover back into place.

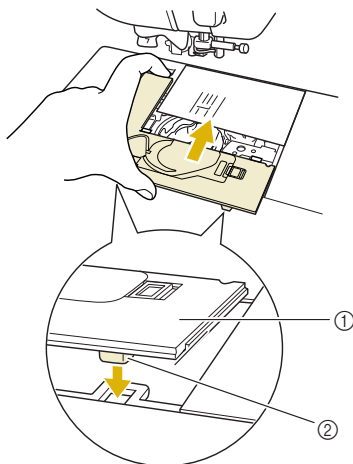

- ① Needle plate cover  
② Tabs

### Note

- Never use a bobbin case that is scratched; otherwise, the upper thread may become tangled, the needle may break, or sewing performance may suffer. For a new bobbin case (part code: XC3153-251 (green marking on the screw) (for sewing and embroidering with bobbin thread recommended by Baby lock) or XC8167-451 (no color on the screw) (for embroidering with bobbin threads from other manufacturers)), contact your authorized retailer (see page 141).
- Be sure that the bobbin case is correctly installed. Otherwise, the needle may break.

## Cleaning the Bobbin Case

Thread wax and dust easily collect around the notch in the tension spring on the bobbin case, resulting in an incorrect thread tension. Therefore, the bobbin case should be cleaned as necessary should tension problems arise.

When cleaning the bobbin case, use business card stock or another type of paper of similar thickness and sturdiness in order to prevent pieces of paper tearing off and getting lodged in the bobbin case.

- 1** Follow steps “Cleaning the Race” on page 184.
- 2** Using a piece of paper of adequate thickness and sturdiness, slide the paper between the tension plate base and the tension spring and also slide the paper behind the notch of the spring to remove any dirt or dust.

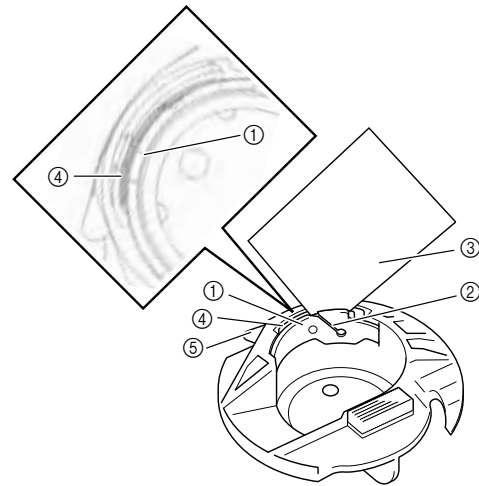

- ① Tension plate base  
② Notch  
③ Paper (e.g. business card type)  
④ Tension spring  
⑤ Bobbin case projection (stopper)



### Memo

Do not bend the tension spring. In addition, do not use anything other than recommended paper to clean the bobbin case.

- 3** Use the included cleaning brush to remove any lint and dust from inside the bobbin case.
- 4** Reinsert the bobbin case and needle plate cover assuring the bobbin case projection (stopper) is touching the bracket spring. (Follow steps 9 and 10 from the previous section.)



## ADJUSTING THE SCREEN

### Screen Visibility Is Low

If the screen is difficult to read when the machine is turned on, follow the procedure described below.

- 1 Turn off the machine, hold your finger anywhere on the screen, and then turn the machine on.

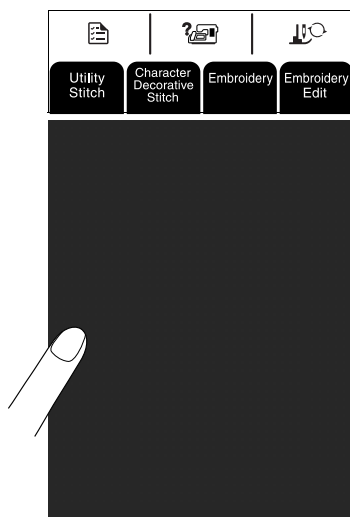

→ The BRIGHTNESS OF LCD screen appears.



#### Memo

Continue touching the LCD until the screen shown below appears.

- 2 Press **-** or **+** to adjust the screen until you can see it easily.

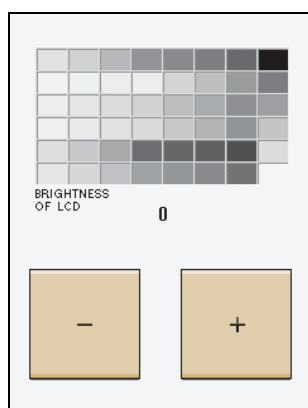

- 3 Turn the machine off, then on again.

### Touch Panel Is Malfunctioning

If the screen does not respond correctly when a key is pressed (the machine does not perform the operation or performs a different operation), follow the procedure described below to make the proper adjustments.

- 1 Turn off the machine, hold your finger anywhere on the screen, and then turn the machine on.

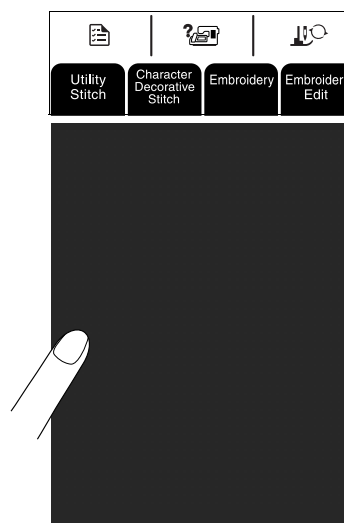

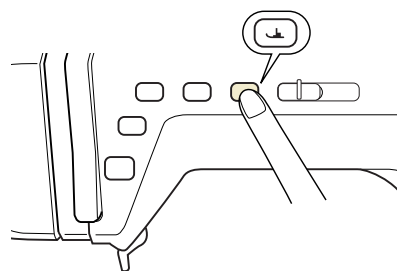

→ The BRIGHTNESS OF LCD screen appears.

- 2 Press the "Presser Foot Lifter" button.



→ The touch panel adjustment screen appears.

**3** Using the included touch pen, lightly touch the center of each , in order from 1 to 5.

- \* If the buzzer sounds one time after you press number 5, the operation is finished, and the mark below 1  appears in black.
- If the buzzer sounds twice, the mark below 1  appears in red, and there was an error. In this case, repeat the steps above.



**Note**

Only use the included touch pen to touch the screen. Do not use a mechanical pencil, screwdriver or any other hard or sharp object. Do not apply a strong force to the display, otherwise damage to the display may result.

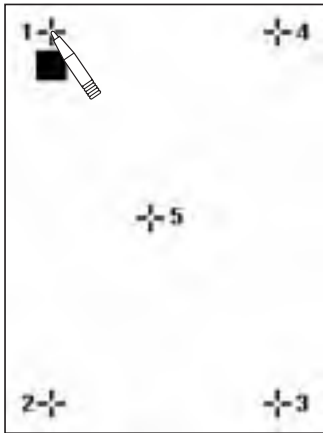

**4** After making the necessary touch panel adjustment, turn the machine off, then on again.



**Note**

If you finish the touch panel adjustment and the screen still does not respond, or if you cannot complete the adjustment, contact your authorized retailer.



# TROUBLESHOOTING

If you have a minor problem with your sewing machine, check the following solutions. If the solutions suggested do not correct the problem, contact your authorized retailer.



## Memo

This machine is equipped with a simple troubleshooting feature that can be used in case minor problems occur during

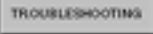
sewing. Press , and then press  to display a list of problems. Press the key for the appropriate problem, and then check for the causes that are displayed.

Problem	Cause	Solution	Page
Upper thread breaks	The machine was threaded incorrectly (the spool is installed incorrectly, the wrong spool cap was used, the needle bar thread guide did not catch the thread, etc.).	Rethread the machine correctly.	29
	The thread is knotted or tangled.	Remove the knots and tangles.	–
	The thread is too thick for the needle.	Check the table of fabric, thread and needle combinations, and select the appropriate combination.	37
	The upper thread tension is too strong.	Adjust the thread tension.	45
	The thread is tangled.	Use scissors, etc., to cut the tangled thread and remove it from the race (bobbin case), etc.	–
	The needle is bent or blunt.	Replace the needle with a new one.	35
	The needle is installed incorrectly.	Reinstall the needle correctly.	35
	There are scratches around the hole in the needle plate.	Replace the needle plate, or consult your authorized retailer.	–
	There are scratches around the hole in the presser foot.	Replace the presser foot, or consult your authorized retailer.	–
	There are scratches on the race (bobbin case).	Replace the race (bobbin case), or consult your authorized retailer.	–
Bobbin thread breaks	Bobbin is set incorrectly.	Reset the bobbin correctly.	27
	There are scratches on the bobbin or it doesn't rotate properly.	Replace the bobbin.	–
	The thread is tangled.	Use scissors etc., to cut the tangled thread and remove it from the race (bobbin case), etc.	–
Skipped stitches	The machine is threaded incorrectly.	Check the procedure for threading the machine and rethread it correctly.	29
	The thread or needle is not suitable for the type of fabric being sewn.	Check the table of fabric, thread and needle combinations, and select the appropriate combination.	37
	The needle is bent or blunt.	Replace the needle with a new one.	35
	The needle is installed incorrectly.	Reinstall the needle correctly.	35
	The needle is defective.	Replace the needle.	35
	Dust or lint has collected under the needle plate.	Remove the dust or lint with the brush.	184
Fabric puckers	The upper or bobbin threading is incorrect.	Check the procedure for threading the machine and rethread it correctly.	27, 29
	The spool is installed incorrectly.	Reinstall the spool correctly.	29
	The thread or needle is not suitable for the type of fabric being sewn.	Check the table of fabric, thread and needle combinations, and select the appropriate combination.	37
	The needle is bent or blunt.	Replace the needle with a new one.	35
	The stitches are too long for sewing lightweight fabrics.	Shorten the stitch length.	44
	The thread tension is set incorrectly.	Adjust the thread tension.	45
	The wrong presser foot was used.	Attach the correct presser foot.	201

Problem	Cause	Solution	Page
High-pitched sound while sewing	Dust or lint is caught in the feed dogs.	Remove the dust or lint.	184
	Pieces of thread are caught in the race (bobbin case).	Clean the race (bobbin case).	184
	The upper threading is incorrect.	Check the procedure for threading the machine and rethread it correctly.	29
	There are scratches on the race (bobbin case).	Replace the race (bobbin case), or consult your authorized retailer.	–
Cannot thread the needle	The needle is not in the correct position.	Press the “Needle Position” button to raise the needle.	11
	The threading hook does not pass through the eye of the needle.	Press the “Needle Position” button to raise the needle.	11
	The needle is installed incorrectly.	Reinstall the needle correctly.	35
Thread tension is incorrect	The upper threading is incorrect.	Check the procedure for threading the machine and rethread it correctly.	29
	Bobbin is set incorrectly.	Reset the bobbin thread correctly.	27
	The thread or needle is not suitable for the type of fabric being sewn.	Check the table of fabric, thread and needle combinations, and select the appropriate combination.	37
	The presser foot holder is not attached correctly.	Reattach the presser foot holder correctly.	68
	The thread tension is set incorrectly.	Adjust the thread tension.	45
Character pattern does not sew out correctly	The wrong presser foot was used.	Attach the correct presser foot.	201
	Pattern adjustment settings were set incorrectly.	Correct the pattern adjustment settings.	98
	A stabilizer material was not used on lightweight fabrics or stretch fabrics.	Attach a stabilizer material.	129
	The thread tension is set incorrectly.	Adjust the thread tension.	45
Embroidery pattern does not sew out correctly	The thread is tangled.	Use scissors, etc., to cut the tangled thread and remove it from the race (bobbin case), etc.	–
	The fabric is incorrectly hooped in the embroidery frame (fabric was loose, etc.).	If the fabric is not stretched tight in the frame, the pattern may be sewn incorrectly or there may be shrinkage of the pattern. Hoop the fabric correctly in the frame.	131
	A stabilizer material was not attached.	Always use stabilizer material, especially with stretch fabrics, lightweight fabrics, fabrics with a coarse weave, or fabrics that often cause pattern shrinkage. Contact your authorized retailer for the proper stabilizer.	129
	There was an object placed near the machine, and the carriage or embroidery frame hit the object during sewing.	If the frame bumps something during sewing, the pattern will turn out poorly. Do not place anything in the area where the frame may bump it during sewing.	–
	Fabric outside of the frame edges interferes with the sewing arm, so the embroidery unit cannot move.	Rehoop the fabric in the embroidery frame so that excess fabric is away from the sewing arm, and rotate the pattern 180 degrees.	131
	The fabric is too heavy, so the embroidery unit cannot move freely.	Place a thick book or similar object under the arm head to lightly lift the heavy side and keep it level.	–
	Fabric is hanging off the table.	If fabric is hanging off the table while embroidering, the embroidery unit will not move freely. Position the fabric so that it does not hang off the table or hold the fabric to keep it from dragging.	142
	The fabric is snagged or caught on something.	Stop the machine, and then correctly position the fabric so that it does not get caught or snagged.	–
	Embroidery frame was removed during sewing (for example, to reset the bobbin). The presser foot was bumped or moved while removing or attaching the embroidery frame, or the embroidery unit was moved.	If the presser foot is bumped or the embroidery unit is moved during sewing, the pattern will not turn out correctly. Be careful when removing or reattaching the embroidery frame during sewing.	145
Loops appear on the surface of the fabric when embroidering	The thread tension is incorrectly set.	Adjust the thread tension.	149 - 150
	The tension of the upper thread is incorrectly set for the combination of the fabric, thread and pattern being used.	Use the embroidery needle plate cover.	142
	The combination of the bobbin case and bobbin thread is incorrect.	Change the bobbin case or bobbin thread so that the correct combination is used.	141



7

Appendix

Problem	Cause	Solution	Page
Needle breaks	The needle is installed incorrectly.	Reinstall the needle correctly.	35
	The needle clamp screw is not tightened.	Tighten the needle clamp screw.	36
	The needle is bent or blunt.	Replace the needle with a new one.	35
	The thread or needle is not suitable for the type of fabric being sewn.	Check the table of fabric, thread and needle combinations, and select the appropriate combination.	37
	The wrong presser foot was used.	Attach the correct presser foot.	201
	The upper thread tension is too strong.	Adjust the thread tension.	45
	The fabric is pulled during sewing.	Do not pull the fabric during sewing.	–
	The spool is installed incorrectly.	Reinstall the spool correctly.	29
	There are scratches around the hole in the needle plate.	Replace the needle plate, or consult your authorized retailer.	–
	There are scratches around the hole(s) in the presser foot.	Replace the presser foot, or consult your authorized retailer.	–
	There are scratches on the race (bobbin case).	Replace the race (bobbin case), or consult your authorized retailer.	–
The needle is defective.	Replace the needle.	35	
The fabric does not feed through the machine	The feed dogs are lowered.	Use the feed dog position switch to raise the feed dogs.	86
	The stitches are too close together.	Lengthen the stitch length.	44
	The wrong presser foot was used.	Attach the correct presser foot.	201
	The needle is bent or blunt.	Replace the needle with a new one.	35
	The thread is tangled.	Use scissors, etc., to cut the tangled thread and remove it from the race (bobbin case), etc.	–
The machine does not operate	There is no pattern selected.	Select a pattern.	50, 94, 124, 167
	The “Start/Stop” button was not pressed.	Press the “Start/Stop” button.	40
	The main power switch is not turned on.	Turn the main power to on.	16
	The presser foot is not lowered.	Lower the presser foot.	40
	The “Start/Stop” button was pressed while the foot controller is connected.	Remove the foot controller, or use the foot controller to operate the machine.	11, 41
	The foot controller was pressed to begin embroidering.	Remove the foot controller and use the “Start/Stop” button to operate the machine.	11
The embroidery unit does not operate	There is no pattern selected.	Select a pattern.	50, 94, 124, 167
	The main power switch is not turned on.	Turn the main power to on.	16
	The embroidery unit is not attached correctly.	Reattach the embroidery unit correctly.	122
	The embroidery frame was attached before the unit was initialized.	Perform the initialization process correctly.	123
The LCD display is difficult to see	The LCD contrast is not properly adjusted.	Adjust the LCD contrast.	21, 186

## CAUTION

- This machine is equipped with a thread detection device. If the “Start/Stop” button is pushed before the upper threading is done, the machine will not operate properly. Also, depending on the pattern selected, the machine may feed the fabric even if the needle is raised. This is due to the needle bar release mechanism. At these times, the machine will make a sound different from that made during normal sewing. This is not the sign of a malfunction.
- If the power is disconnected during sewing:  
Turn the main power to OFF and unplug the machine.  
If you restart the machine, follow the instructions for operating the machine correctly.



# ERROR MESSAGES

If the "Start/Stop button" or the "Reverse/Reinforcement Stitch" button is pressed before the machine is correctly set up or if an incorrect operation is performed, the machine stops and informs you of the error with an alarm and an error message. If an error message appears, correct the problem according to the instructions in the message.

(The message that is displayed can be cancelled either by pressing **CLOSE** or performing the operation correctly.)



This message is displayed if a malfunction occurred.



This message is displayed when the "Start/Stop" button is pressed, but the embroidery unit is not attached.



This message is displayed when the "Start/Stop" button is pressed in embroidery mode, but the embroidery frame is not attached.



This message is displayed when the pattern selected in embroidery mode is larger than the embroidering area of the small embroidery frame while the small embroidery frame is attached.



This confirmation message appears after the machine is turned on and the carriage of the embroidery unit has moved to its initial position.



This message is displayed when the pattern selected in embroidery mode is larger than the embroidering area of the large embroidery frame while the small, medium or large embroidery frame is attached.



This message is displayed when there are too many characters to be arranged in the curved character configuration.



This message is displayed when the pattern selected in embroidery mode is larger than the embroidering area of the medium embroidery frame while the small or medium embroidery frame is attached.





This message is displayed when the upper thread is broken or not threaded correctly, and the "Start/Stop" button or the "Reverse/Reinforcement Stitch" button is pressed.



This message is displayed when you try to use the needle threader lever while twin needle sewing is set.

**! CAUTION**

- **Be sure to rethread the machine. If you press the "Start/Stop" button without rethreading the machine, the thread tension may be wrong or the needle may break and cause injury.**



This message is displayed when a buttonhole stitch is selected and the "Start/Stop" button or the "Reverse/Reinforcement Stitch" button is pressed while the buttonhole lever is raised.



This message is displayed when using USB cable to download information from PC to machine.



This message is displayed when the "Start/Stop" button, "Reverse/Reinforcement Stitch" button, "Thread Cutter" button, or "Presser Foot Lifter" button is pressed while the presser foot lever is raised/the needle is lowered.



This message is displayed when the patterns you are editing take up too much memory, or if you are editing too many patterns for the memory.



This message is displayed when you try to combine more than 70 patterns.



This message is displayed when the "Start/Stop" button is pressed while a pattern is being edited in embroidery edit mode.



This message is displayed when the memory is full and the stitch or pattern cannot be saved.



This message is displayed when the memory in the USB media is full and the stitch or pattern cannot be saved.



This message is displayed when **MEMORY** is pressed while a utility stitch is selected.



This message is displayed when  is pressed while the presser foot is raised.



This message is displayed when a stitch other than a buttonhole stitch is selected and the "Start/Stop" button or the "Reverse/Reinforcement Stitch" button is pressed while the buttonhole lever is lowered.



This message is displayed when **Utility Stitch**, **Character Decorative Stitch**, **Embroidery**, or **Embroidery Edit** is pressed after a pattern is selected.

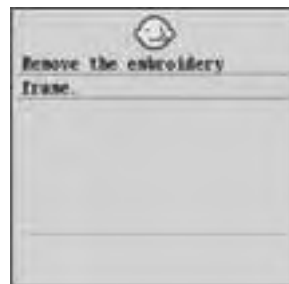

This message is displayed when the embroidery unit tries to initialize in embroidery mode while an embroidery frame is attached.

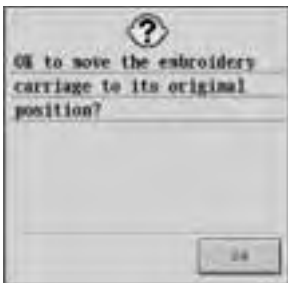

This message is displayed when replacing the embroidering bobbin thread.



This message is displayed when a previously saved pattern is being retrieved in embroidery edit mode.



This message is displayed when **RESET** is pressed when changing thread colors.

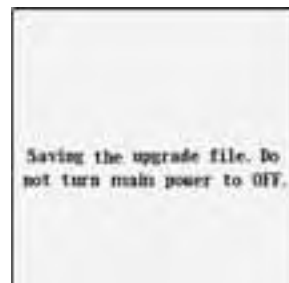

This message is displayed while upgrade file is being downloaded to machine.





This message is displayed when the "Start/Stop" button, "Reverse/Reinforcement Stitch" button is pressed while no pattern is selected.



This message is displayed when the machine is turned on while the needle is lowered and the embroidery unit is attached.



This message is displayed when the bobbin thread is running out.



This message is displayed when the combined character pattern in embroidery mode is too large for the embroidery frame. You can rotate the pattern 90 degrees to continue combining characters.



This message is displayed when the bobbin is being wound, and the motor locks because the thread is tangled, etc.



This message is displayed when the combined character pattern in embroidery mode is too large for the embroidery frame.



This message is displayed when the embroidery unit is initializing.



This message is displayed when the presser foot is lowered and



is pressed while the embroidery unit is attached.



This message is displayed when the foot controller is pressed while the embroidery unit is attached.



This message is displayed when you try to save a copyright protected pattern to USB media/Computer. According to copyright laws, patterns that are illegal to reproduce or edit cannot be saved to USB media/Computer. If this message displays, save the pattern in the machine's memory.



This message is displayed when  is pressed without an embroidery card inserted.



This message is displayed when the "Reverse/Reinforcement Stitch" button is pressed while the embroidery unit is attached.



This message is displayed when the "Start/Stop" button is pressed while the foot controller is connected.

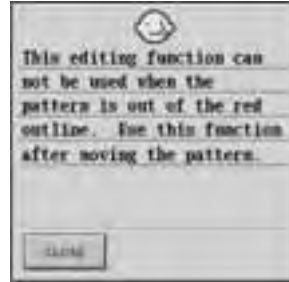

This message is displayed when the machine is in embroidery edit mode, and you try to use an editing function when the pattern is not completely within the red outline.



This message is displayed when the motor locks up due to tangled thread or for other reasons related to thread delivery.



This message is displayed when  is pressed while an incompatible embroidery card is inserted.



This message is displayed when you attempt to select a pattern after the USB media in which the pattern is saved has been changed.



This message is displayed when an embroidery frame not for use with this machine is attached while the embroidery unit is attached.



This message is displayed when the Utility Stitch key or Character/Decorative Stitch key is pressed while the embroidery unit is attached.

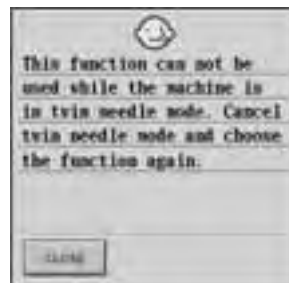

This message is displayed when the machine is set for twin needle sewing and a pattern that cannot be sewn with the twin needle is selected.



This message is displayed when a button on the screen is pressed while the needle is lowered.



This message is displayed when the needle plate is removed with the machine on or when the single-hole needle plate is installed when the machine is turned on in the embroidery or embroidery edit mode.



This message is displayed when a large-size embroidery pattern is selected in Embroidery Edit mode.



This message is displayed when an error occurs with the USB media.



This message is displayed when you try to use incompatible media.



This message is displayed when you try to retrieve or save a pattern while no USB media is loaded.



This message is displayed while the USB media is transmitting.



This message is displayed when the "Start/Stop" button, "Reverse/Reinforcement Stitch" button, or the "Thread Cutter" button is pressed while the presser foot and the needle are raised.



This message is displayed when you try to sew with a stitch other than a middle needle position stitch while the single-hole needle plate is installed.



This message is displayed when the "Start/Stop" button is pressed while the sewing speed controller is set to control the zigzag stitch width.

### ■ Alarm

If an incorrect operation is performed, the machine beeps two or four times.



### Memo

To turn the alarm on or off, press . For details, see page 21.

# SPECIFICATIONS

	Item	Specification
Sewing Machine	Dimensions	51.1 cm (W) × 30.5 cm (H) × 25.8 cm (D) (approx. 20-1/8 inches (W) × 12 inches (H) × 10-1/8 inches (D))
	Case dimensions	58.2 cm (W) × 31.9 cm (H) × 28.4 cm (D) (approx. 22-7/8 inches (W) × 12-1/2 inches (H) × 11-1/8 inches (D))
	Weight	11.2 kg (24.7 lb.) (with case: 13.5 kg (29.8 lb.))
	Sewing speed	70 to 1000 stitches per minute
	Needle	Home sewing machine needles (HA × 130)
Embroidery Unit	Dimensions	45.8 cm (W) × 13.1 cm (H) × 42.3 cm (D) (approx. 18 inches (W) × 5-1/8 inches (H) × 16-3/4 inches (D))
	Dimension of machine with embroidery unit attached	72.4 cm (W) × 30.5 cm (H) × 42.3 cm (D) (approx. 28-1/2 inches (W) × 12 inches (H) × 16-3/4 inches (D))
	Weight	3.5 kg (7.7 lb.)



7

# UPGRADING YOUR MACHINE'S SOFTWARE

You can use USB media or a computer to download software upgrades (file extension .up1) for your sewing machine.

## Memo

- When the machine's software is upgraded, saved combinations of character and decorative stitches are erased. However, saved embroidery patterns are not erased.
- While the software is being upgraded, the buzzer will not sound when a key is pressed.

## Upgrade Procedure Using USB Media

- 1 While holding the "Presser Foot Lifter" button pressed, turn on the machine.

→ The following screen appears.

- 2 Press  .

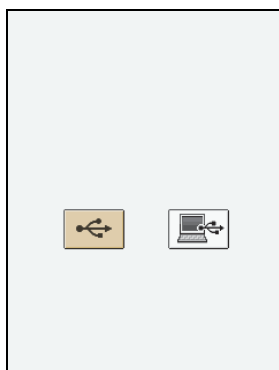

- 3 Insert the USB media into the USB port connector on the machine, making sure the media only contains the upgrade file.

- 4 Press  .

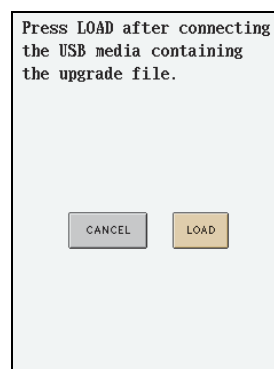

→ The message "Saving the upgrade file. Do not turn main power to OFF." will appear.

- 5 When the following screen appears, upgrading is completed.

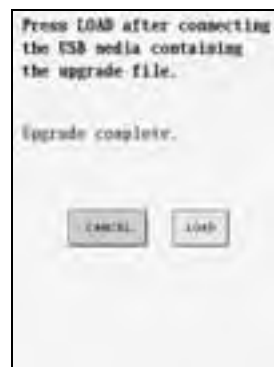

## Note

If an error occurred, an error message appears in red. At this time, turn the machine off, and then start the procedure again from step 1.

- 6 Remove the USB media, and turn the machine off, then on again.



## Upgrade Procedure Using Computer

- 1 While holding the "Presser Foot Lifter" button pressed, turn on the machine.

→ The following screen appears.

- 2 Press .

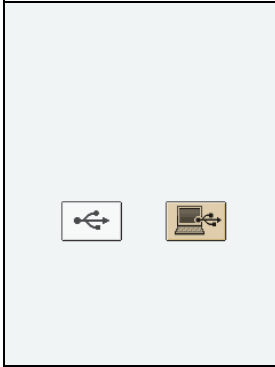

- 3 Plug the USB cable connectors into the corresponding USB port connectors on the computer and on the machine.

→ The "Removable Disk" icon appears in "My Computer" on the computer.

- 4 Copy the upgrade file to "Removable Disk".



→ The message "Connected to PC. Do not disconnect the USB cable." will appear.

- 5 Press .

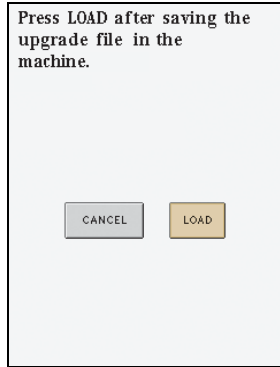

→ The message "Saving the upgrade file. Do not turn main power to OFF." will appear.

- 6 When the following screen appears, upgrading is completed.



### Note

If an error occurred, an error message appears in red. At this time, turn the machine off, and then start the procedure again from step 1.

- 7 Disconnect the USB cable, and turn the machine off, then on again.



7

Appendix











































# STITCH SETTING CHART









































**Note**

When using the twin needle (see page 32), be sure to attach presser foot “J”.









































Stitch Key	Stitch Name	Presser Foot	Applications	Stitch Width [mm (inch)]		Stitch Length [mm (inch)]		Twin Needle
				Auto.	Manual	Auto.	Manual	
	<b>Straight stitch (Left)</b>		General sewing, gather, pintuck, etc. Reverse stitch is sewn while pressing “Reverse/ Reinforcement Stitch” button.	<b>0.0 (0)</b>	0.0 - 7.0 (0 - 1/4)	<b>2.5 (3/32)</b>	0.2 - 5.0 (1/64 - 3/16)	OK (J)
	<b>Straight stitch (Left)</b>		General sewing, gather, pintuck, etc. Reinforcement stitch is sewn while pressing “Reverse/ Reinforcement Stitch” button.	<b>0.0 (0)</b>	0.0 - 7.0 (0 - 1/4)	<b>2.5 (3/32)</b>	0.2 - 5.0 (1/64 - 3/16)	OK (J)
	<b>Straight stitch (Middle)</b>		General sewing, gather, pintuck, etc. Reverse stitch is sewn while pressing “Reverse/ Reinforcement Stitch” button.	<b>3.5 (1/8)</b>	0.0 - 7.0 (0 - 1/4)	<b>2.5 (3/32)</b>	0.2 - 5.0 (1/64 - 3/16)	OK (J)
	<b>Straight stitch (Middle)</b>		General sewing, gather, pintuck, etc. Reinforcement stitch is sewn while pressing “Reverse/ Reinforcement Stitch” button.	<b>3.5 (1/8)</b>	0.0 - 7.0 (0 - 1/4)	<b>2.5 (3/32)</b>	0.2 - 5.0 (1/64 - 3/16)	OK (J)
	<b>Triple stretch stitch</b>		General sewing for reinforcement and decorative top stitching	<b>0.0 (0)</b>	0.0 - 7.0 (0 - 1/4)	<b>2.5 (3/32)</b>	1.5 - 4.0 (1/16 - 3/16)	OK (J)
	<b>Stretch stitch</b>		Reinforced stitching, sewing and decorative applications	<b>1.0 (1/16)</b>	1.0 - 3.0 (1/16 - 1/8)	<b>2.5 (3/32)</b>	1.0 - 4.0 (1/16 - 3/16)	OK (J)
	<b>Decorative stitch</b>		Decorative stitching, top stitching	<b>0.0 (0)</b>	0.0 - 7.0 (0 - 1/4)	<b>2.5 (3/32)</b>	1.0 - 4.0 (1/16 - 3/16)	OK (J)
	<b>Basting stitch</b>		Basting	<b>0.0 (0)</b>	0.0 - 7.0 (0 - 1/4)	<b>20.0 (3/4)</b>	5.0 - 30.0 (3/16 - 1-3/16)	NO
	<b>Zigzag stitch (Middle)</b>		For overcasting, mending. Reverse stitch is sewn while pressing “Reverse/ Reinforcement Stitch” button.	<b>3.5 (1/8)</b>	0.0 - 7.0 (0 - 1/4)	<b>1.4 (1/16)</b>	0.0 - 4.0 (0 - 3/16)	OK (J)
	<b>Zigzag stitch (Middle)</b>		For overcasting, mending. Reinforcement stitch is sewn while pressing “Reverse/ Reinforcement Stitch” button.	<b>3.5 (1/8)</b>	0.0 - 7.0 (0 - 1/4)	<b>1.4 (1/16)</b>	0.0 - 4.0 (0 - 3/16)	OK (J)
	<b>Zigzag stitch (Right)</b>		Start from right needle position, zigzag sew at left.	<b>3.5 (1/8)</b>	2.5 - 5.0 (3/32 - 3/16)	<b>1.4 (1/16)</b>	0.3 - 4.0 (1/64 - 3/16)	OK (J)
	<b>Zigzag stitch (Left)</b>		Start from left needle position, zigzag sew at right.	<b>3.5 (1/8)</b>	2.5 - 5.0 (3/32 - 3/16)	<b>1.4 (1/16)</b>	0.3 - 4.0 (1/64 - 3/16)	OK (J)
	<b>2 step elastic zigzag</b>		Overcasting (medium weight and stretch fabrics), tape and elastic	<b>5.0 (3/16)</b>	1.5 - 7.0 (1/16 - 1/4)	<b>1.0 (1/16)</b>	0.2 - 4.0 (1/64 - 1/16)	OK (J)
	<b>3 step elastic zigzag</b>		Overcasting (medium, heavyweight and stretch fabrics), tape and elastic	<b>5.0 (3/16)</b>	1.5 - 7.0 (1/16 - 1/4)	<b>1.0 (1/16)</b>	0.2 - 4.0 (1/64 - 1/16)	OK (J)
	<b>Overcasting stitch</b>		Reinforcing of light and medium weight fabrics	<b>3.5 (1/8)</b>	2.5 - 5.0 (3/32 - 3/16)	<b>2.0 (1/16)</b>	1.0 - 4.0 (1/16 - 3/16)	NO



























Stitch Key	Stitch Name	Presser Foot	Applications	Stitch Width [mm (inch)]		Stitch Length [mm (inch)]		Twin Needle
				Auto.	Manual	Auto.	Manual	
	Overcasting stitch		Reinforcing of heavyweight fabric	<b>5.0</b> <b>(3/16)</b>	2.5 - 5.0 (3/32 - 3/16)	<b>2.5</b> <b>(3/32)</b>	1.0 - 4.0 (1/16 - 3/16)	NO
	Overcasting stitch		Reinforcing of medium, heavyweight and easily friable fabrics or decorative stitching.	<b>5.0</b> <b>(3/16)</b>	3.5 - 5.0 (1/8 - 3/16)	<b>2.5</b> <b>(3/32)</b>	1.0 - 4.0 (1/16 - 3/16)	NO
	Overcasting stitch		Reinforced seaming of stretch fabric	<b>5.0</b> <b>(3/16)</b>	0.0 - 7.0 (0 - 9/32)	<b>2.5</b> <b>(3/32)</b>	0.5 - 4.0 (1/32 - 3/16)	OK ( J )
	Overcasting stitch		Reinforcing of medium stretch fabric and heavyweight fabric, decorative stitching	<b>5.0</b> <b>(3/16)</b>	0.0 - 7.0 (0 - 9/32)	<b>2.5</b> <b>(3/32)</b>	0.5 - 4.0 (1/32 - 3/16)	OK ( J )
	Overcasting stitch		Reinforcement of stretch fabric or decorative stitching	<b>4.0</b> <b>(3/16)</b>	0.0 - 7.0 (0 - 1/4)	<b>4.0</b> <b>(3/16)</b>	1.0 - 4.0 (1/16 - 3/16)	OK ( J )
	Overcasting stitch		Stretch knit seam	<b>5.0</b> <b>(3/16)</b>	0.0 - 7.0 (0 - 1/4)	<b>4.0</b> <b>(3/16)</b>	1.0 - 4.0 (1/16 - 3/16)	NO
	Single diamond overcast		Reinforcement and seaming stretch fabric	<b>6.0</b> <b>(15/64)</b>	1.0 - 7.0 (1/16 - 1/4)	<b>3.0</b> <b>(1/8)</b>	1.0 - 4.0 (1/16 - 3/16)	OK ( J )
	Single diamond overcast		Reinforcement of stretch fabric	<b>6.0</b> <b>(15/64)</b>	1.0 - 7.0 (1/16 - 1/4)	<b>1.8</b> <b>(1/16)</b>	1.0 - 4.0 (1/16 - 3/16)	OK ( J )
	With side cutter		Straight stitch while cutting fabrics	<b>0.0</b> <b>(0)</b>	0.0 - 2.5 (0 - 3/32)	<b>2.5</b> <b>(3/32)</b>	0.2 - 5.0 (1/64 - 3/16)	NO
	With side cutter		Zigzag stitch while cutting fabrics	<b>3.5</b> <b>(1/8)</b>	3.5 - 5.0 (1/8 - 3/16)	<b>1.4</b> <b>(1/16)</b>	0.0 - 4.0 (0 - 3/16)	NO
	With side cutter		Overcasting stitch while cutting fabrics	<b>3.5</b> <b>(1/8)</b>	3.5 - 5.0 (1/8 - 3/16)	<b>2.0</b> <b>(1/16)</b>	1.0 - 4.0 (1/16 - 3/16)	NO
	With side cutter		Overcasting stitch while cutting fabrics	<b>5.0</b> <b>(3/16)</b>	3.5 - 5.0 (1/8 - 3/16)	<b>2.5</b> <b>(3/32)</b>	1.0 - 4.0 (1/16 - 3/16)	NO
	With side cutter		Overcasting stitch while cutting fabrics	<b>5.0</b> <b>(3/16)</b>	3.5 - 5.0 (1/8 - 3/16)	<b>2.5</b> <b>(3/32)</b>	1.0 - 4.0 (1/16 - 3/16)	NO
	Piecing stitch (Right)		Piecework/patchwork 6.5 mm (approx. 1/4 inch) right seam allowance	<b>5.5</b> <b>(7/32)</b>	0.0 - 7.0 (0 - 1/4)	<b>2.0</b> <b>(1/16)</b>	0.2 - 5.0 (1/64 - 3/16)	NO
	Piecing stitch (Middle)		Piecework/patchwork	—	—	<b>2.0</b> <b>(1/16)</b>	0.2 - 5.0 (1/64 - 3/16)	NO
	Piecing stitch (Left)		Piecework/patchwork 6.5 mm (approx. 1/4 inch) left seam allowance	<b>1.5</b> <b>(1/16)</b>	0.0 - 7.0 (0 - 1/4)	<b>2.0</b> <b>(1/16)</b>	0.2 - 5.0 (1/64 - 3/16)	NO
	Hand-look quilting		Quilting stitch made to look like hand quilting stitch	<b>0.0</b> <b>(0)</b>	0.0 - 7.0 (0 - 1/4)	<b>2.5</b> <b>(3/32)</b>	1.0 - 4.0 (1/16 - 3/16)	NO
	Quilting appliqué zigzag stitch		Zigzag stitch for quilting and sewing on appliqué quilt pieces	<b>3.5</b> <b>(1/8)</b>	0.0 - 7.0 (0 - 1/4)	<b>1.4</b> <b>(1/16)</b>	0.0 - 4.0 (0 - 3/16)	NO
	Quilting appliqué stitch		Quilting stitch for invisible appliqué or attaching binding	<b>1.5</b> <b>(1/16)</b>	0.5 - 5.0 (1/64 - 3/16)	<b>1.8</b> <b>(1/16)</b>	1.0 - 4.0 (1/16 - 3/16)	NO
	Quilting stippling		Background quilting	<b>7.0</b> <b>(1/4)</b>	1.0 - 7.0 (1/16 - 1/4)	<b>1.6</b> <b>(1/16)</b>	1.0 - 4.0 (1/16 - 3/16)	NO

Stitch Key	Stitch Name	Presser Foot	Applications	Stitch Width [mm (inch)]		Stitch Length [mm (inch)]		Twin Needle
				Auto.	Manual	Auto.	Manual	
	Blind hem stitch		Hemming woven fabrics	00	3← →3	2.0 (1/16)	1.0 - 3.5 (1/16 - 1/8)	NO
	Blind hem stretch		Hemming stretch fabric	00	3← →3	2.0 (1/16)	1.0 - 3.5 (1/16 - 1/8)	NO
	Blanket stitch		Appliqués, decorative blanket stitch	3.5 (1/8)	2.5 - 7.0 (3/32 - 1/4)	2.5 (3/32)	1.6 - 4.0 (1/16 - 3/16)	OK (J)
	Shell tuck edge		Shell tuck edge finish on fabrics	4.0 (3/16)	0.0 - 7.0 (0 - 1/4)	2.5 (3/32)	0.2 - 4.0 (1/64 - 1/16)	OK (J)
	Satin scallop stitch		Decorating collar of blouse, edge of handkerchief	5.0 (3/16)	2.5 - 7.0 (3/32 - 1/4)	0.5 (1/32)	0.1 - 1.0 (1/64 - 1/16)	OK (J)
	Scallop stitch		Decorating collar of blouse, edge of handkerchief	7.0 (1/4)	0.0 - 7.0 (0 - 1/4)	1.4 (1/16)	1.0 - 4.0 (1/16 - 3/16)	NO
	Patchwork join stitch		Patchwork stitches, decorative stitching	4.0 (1/16)	0.0 - 7.0 (0 - 1/4)	1.2 (1/16)	0.2 - 4.0 (1/64 - 1/16)	OK (J)
	Patchwork double overlock stitch		Patchwork stitches, decorative stitching	5.0 (3/16)	2.5 - 7.0 (3/32 - 1/4)	2.5 (3/32)	1.0 - 4.0 (1/16 - 3/16)	OK (J)
	Couching stitch		Decorative stitching, attaching cord and couching	5.0 (3/16)	0.0 - 7.0 (0 - 1/4)	1.2 (1/16)	0.2 - 4.0 (1/64 - 1/16)	OK (J)
	Smocking stitch		Smocking, decorative stitching	5.0 (3/16)	0.0 - 7.0 (0 - 1/4)	1.6 (1/16)	1.0 - 4.0 (1/16 - 3/16)	OK (J)
	Feather stitch		Fagoting, decorative stitching	5.0 (3/16)	0.0 - 7.0 (0 - 1/4)	2.5 (3/32)	1.0 - 4.0 (1/16 - 3/16)	OK (J)
	Fagoting cross stitch		Fagoting, bridging and decorative stitching	5.0 (3/16)	2.5 - 7.0 (3/32 - 1/4)	2.5 (3/32)	1.0 - 4.0 (1/16 - 3/16)	OK (J)
	Tape attaching		Attaching tape to seam in stretch fabric	4.0 (3/16)	0.0 - 7.0 (0 - 1/4)	1.0 (1/16)	0.2 - 4.0 (1/61 - 3/16)	OK (J)
	Ladder stitch		Decorative stitching	4.0 (3/16)	0.0 - 7.0 (0 - 1/4)	3.0 (1/8)	2.0 - 4.0 (1/16 - 3/16)	NO
	Rick-rack stitch		Decorative top stitching	4.0 (3/16)	0.0 - 7.0 (0 - 1/4)	2.5 (3/32)	1.0 - 4.0 (1/16 - 3/16)	OK (J)
	Decorative stitch		Decorative stitching	5.5 (3/16)	0.0 - 7.0 (0 - 1/4)	1.6 (1/16)	1.0 - 4.0 (1/16 - 3/16)	OK (J)
	Serpentine stitch		Decorative stitching and attaching elastic	5.0 (3/16)	1.5 - 7.0 (1/16 - 1/4)	1.0 (1/16)	0.2 - 4.0 (1/64 - 3/16)	OK (J)
	Decorative stitch		Decorative stitching and appliqué	6.0 (15/64)	1.0 - 7.0 (1/16 - 1/4)	1.0 (1/16)	0.2 - 4.0 (1/64 - 3/16)	OK (J)
	Decorative stippling stitch		Decorative stitching	7.0 (1/4)	1.0 - 7.0 (1/16 - 1/4)	1.6 (1/16)	1.0 - 4.0 (1/16 - 3/16)	NO

STITCH SETTING CHART

Stitch Key	Stitch Name	Presser Foot	Applications	Stitch Width [mm (inch)]		Stitch Length [mm (inch)]		Twin Needle
				Auto.	Manual	Auto.	Manual	
	Hemstitching		Decorative hems, triple straight at left	1.0 (1/16)	1.0 - 7.0 (1/16 - 1/4)	2.5 (3/32)	1.5 - 4.0 (1/16 - 3/16)	OK (J)
	Hemstitching		Decorative hems, triple straight at center	3.5 (1/8)	1.0 - 7.0 (1/16 - 1/4)	2.5 (3/32)	1.5 - 4.0 (1/16 - 3/16)	OK (J)
	Hemstitching zigzag		Decorative hems, top stitching	6.0 (15/64)	1.5 - 7.0 (1/16 - 1/4)	3.0 (1/8)	1.0 - 4.0 (1/16 - 3/16)	OK (J)
	Hemstitching		Decorative hems, lace attaching pin stitch	3.5 (1/8)	1.5 - 7.0 (1/16 - 1/4)	2.5 (3/32)	1.6 - 4.0 (1/16 - 3/16)	NO
	Hemstitching		Decorative hems	3.0 (1/8)	1.5 - 7.0 (1/16 - 1/4)	3.5 (1/8)	1.6 - 4.0 (1/16 - 3/16)	NO
	Hemstitching		Decorative hems daisy stitch	6.0 (15/64)	1.5 - 7.0 (1/16 - 1/4)	3.0 (1/8)	1.5 - 4.0 (1/16 - 3/16)	NO
	Hemstitching		Heirloom, decorative hems	5.0 (3/16)	1.5 - 7.0 (1/16 - 1/4)	3.5 (1/8)	1.6 - 4.0 (1/16 - 3/16)	NO
	Hemstitching		Heirloom, decorative hems	5.0 (3/16)	1.5 - 7.0 (1/16 - 1/4)	3.5 (1/8)	1.5 - 4.0 (1/16 - 3/16)	NO
	Hemstitching		Heirloom, decorative hems	5.0 (3/16)	1.5 - 7.0 (1/16 - 1/4)	3.5 (1/8)	1.6 - 4.0 (1/16 - 3/16)	OK (J)
	Hemstitching		Heirloom, decorative hems	5.0 (3/16)	1.5 - 7.0 (1/16 - 1/4)	4.0 (3/16)	1.5 - 4.0 (1/16 - 3/16)	OK (J)
	Hemstitching		Heirloom, decorative hems	4.0 (3/16)	1.5 - 7.0 (1/16 - 1/4)	2.5 (3/32)	1.5 - 4.0 (1/16 - 3/16)	OK (J)
	Honeycomb stitch		Heirloom, decorative hems	5.0 (3/64)	1.5 - 7.0 (1/16 - 1/4)	2.5 (3/32)	1.5 - 4.0 (1/16 - 3/16)	OK (J)
	Honeycomb stitch		Heirloom, decorative hems	6.0 (15/64)	1.5 - 7.0 (1/16 - 1/4)	3.5 (1/8)	1.5 - 4.0 (1/16 - 3/16)	OK (J)
	Hemstitching		Heirloom, decorative hems	6.0 (15/64)	1.5 - 7.0 (1/16 - 1/4)	1.6 (1/16)	1.0 - 4.0 (1/16 - 3/16)	OK (J)
	Hemstitching		Heirloom, decorative hems	6.0 (15/64)	1.5 - 7.0 (1/16 - 1/4)	3.0 (1/8)	1.5 - 4.0 (1/16 - 3/16)	NO
	Hemstitching		Heirloom, decorative hems	6.0 (15/64)	1.5 - 7.0 (1/16 - 1/4)	4.0 (3/16)	1.5 - 4.0 (1/16 - 3/16)	OK (J)
	Hemstitching		Heirloom, decorative hems	4.0 (3/16)	1.5 - 7.0 (1/16 - 1/4)	2.5 (3/32)	1.6 - 4.0 (1/16 - 3/16)	NO
	Hemstitching		Heirloom, decorative hems	5.0 (3/16)	1.5 - 7.0 (1/16 - 1/4)	2.0 (1/16)	1.5 - 4.0 (1/16 - 3/16)	OK (J)
	Hemstitching		Decorative hems and bridging stitch	6.0 (15/64)	1.5 - 7.0 (1/16 - 1/4)	2.0 (1/16)	1.5 - 4.0 (1/16 - 3/16)	OK (J)
	Hemstitching		Decorative hems. Fagoting, attaching ribbon	5.0 (3/16)	1.5 - 7.0 (1/16 - 1/4)	3.0 (1/8)	1.5 - 4.0 (1/16 - 3/16)	OK (J)

Stitch Key	Stitch Name	Presser Foot	Applications	Stitch Width [mm (inch)]		Stitch Length [mm (inch)]		Twin Needle
				Auto.	Manual	Auto.	Manual	
	<b>Hemstitching</b>		Decorative hems, smocking	<b>6.0 (15/64)</b>	1.5 - 7.0 (1/16 - 1/4)	<b>1.6 (1/16)</b>	1.0 - 4.0 (1/16 - 3/16)	NO
	<b>Hemstitching</b>		Decorative hems, smocking	<b>5.0 (3/16)</b>	1.5 - 7.0 (1/16 - 1/4)	<b>1.6 (1/16)</b>	1.0 - 4.0 (1/16 - 3/16)	NO
	<b>Narrow rounded buttonhole</b>		Buttonhole on light to medium weight fabrics	<b>5.0 (3/16)</b>	3.0 - 5.0 (1/8 - 3/16)	<b>0.4 (1/64)</b>	0.2 - 1.0 (1/64 - 1/16)	NO
	<b>Wide round ended buttonhole</b>		Buttonholes with extra space for larger buttons	<b>5.5 (7/32)</b>	3.5 - 5.5 (1/8 - 7/32)	<b>0.4 (1/64)</b>	0.2 - 1.0 (1/64 - 1/16)	NO
	<b>Tapered round ended buttonhole</b>		Reinforced waist tapered buttonholes	<b>5.0 (3/16)</b>	3.0 - 5.0 (1/8 - 3/16)	<b>0.4 (1/64)</b>	0.2 - 1.0 (1/64 - 1/16)	NO
	<b>Round ended buttonhole</b>		Buttonholes with vertical bar tack in heavyweight fabrics	<b>5.0 (3/16)</b>	3.0 - 5.0 (1/8 - 3/16)	<b>0.4 (1/64)</b>	0.2 - 1.0 (1/64 - 1/16)	NO
	<b>Round ended buttonhole</b>		Buttonholes with bar tack	<b>5.0 (3/16)</b>	3.0 - 5.0 (1/8 - 3/16)	<b>0.4 (1/64)</b>	0.2 - 1.0 (1/64 - 1/16)	NO
	<b>Round double ended buttonhole</b>		Buttonholes for fine, medium to heavyweight fabrics	<b>5.0 (3/16)</b>	3.0 - 5.0 (1/8 - 3/16)	<b>0.4 (1/64)</b>	0.2 - 1.0 (1/64 - 1/16)	NO
	<b>Narrow squared buttonhole</b>		Buttonholes for light to medium weight fabrics	<b>5.0 (3/16)</b>	3.0 - 5.0 (1/8 - 3/16)	<b>0.4 (1/64)</b>	0.2 - 1.0 (1/64 - 1/16)	NO
	<b>Wide squared buttonhole</b>		Buttonholes with extra space for larger decorative buttons	<b>5.5 (7/32)</b>	3.5 - 5.5 (1/8 - 7/32)	<b>0.4 (1/64)</b>	0.2 - 1.0 (1/64 - 1/16)	NO
	<b>Stretch buttonhole</b>		Buttonholes for stretch or woven fabrics	<b>6.0 (15/64)</b>	3.0 - 6.0 (1/8 - 15/64)	<b>1.0 (1/16)</b>	0.5 - 2.0 (1/32 - 1/16)	NO
	<b>Heirloom buttonhole</b>		Buttonholes for heirloom and stretch fabrics	<b>6.0 (15/64)</b>	3.0 - 6.0 (1/8 - 15/64)	<b>1.5 (1/16)</b>	1.0 - 3.0 (1/16 - 1/8)	NO
	<b>Bound buttonhole</b>		The first step in making bound buttonholes	<b>5.0 (3/16)</b>	0.0 - 6.0 (0 - 15/64)	<b>2.0 (1/16)</b>	0.2 - 4.0 (1/64 - 3/16)	NO
	<b>Keyhole buttonhole</b>		Buttonholes in heavyweight or thick fabrics for larger flat buttons	<b>7.0 (1/4)</b>	3.0 - 7.0 (1/8 - 1/4)	<b>0.5 (1/32)</b>	0.3 - 1.0 (1/64 - 1/16)	NO
	<b>Tapered keyhole buttonhole</b>		Buttonholes in medium to heavy weight fabrics for larger flat buttons	<b>7.0 (1/4)</b>	3.0 - 7.0 (1/8 - 1/4)	<b>0.5 (1/32)</b>	0.3 - 1.0 (1/64 - 1/16)	NO
	<b>Keyhole buttonhole</b>		Buttonholes with vertical bar tack for reinforcement in heavyweight or thick fabrics	<b>7.0 (1/4)</b>	3.0 - 7.0 (1/8 - 1/4)	<b>0.5 (1/32)</b>	0.3 - 1.0 (1/64 - 1/16)	NO
	<b>Darning</b>		Darning of medium weight fabric	<b>7.0 (1/4)</b>	2.5 - 7.0 (3/32 - 1/4)	<b>2.0 (1/16)</b>	0.4 - 2.5 (1/64 - 1/16)	NO
	<b>Darning</b>		Darning of heavyweight fabric	<b>7.0 (1/4)</b>	2.5 - 7.0 (3/32 - 1/4)	<b>2.0 (1/16)</b>	0.4 - 2.5 (1/64 - 1/16)	NO
	<b>Bar tack</b>		Reinforcement at opening of pocket, etc.	<b>2.0 (1/16)</b>	1.0 - 3.0 (1/16 - 1/8)	<b>0.4 (1/64)</b>	0.3 - 1.0 (1/64 - 1/16)	NO
	<b>Button sewing</b>		Attaching buttons	<b>3.5 (1/8)</b>	2.5 - 4.5 (3/32 - 3/16)	—	—	NO

Stitch Key	Stitch Name	Presser Foot	Applications	Stitch Width [mm (inch)]		Stitch Length [mm (inch)]		Twin Needle
				Auto.	Manual	Auto.	Manual	
	<b>Eyelet</b>		For making eyelets, holes on belts, etc.	<b>7.0 (1/4)</b>	7.0 6.0 5.0 (1/4 15/64 3/16)	<b>7.0 (1/4)</b>	7.0 6.0 5.0 (1/4 15/64 3/16)	NO
	<b>Diagonally left up (Straight)</b>		For attaching appliqué on tubular pieces of fabric and mitering corners	—	—	—	—	NO
	<b>Reverse (Straight)</b>		For attaching appliqué on tubular pieces of fabric and mitering corners	—	—	—	—	NO
	<b>Diagonally right up (Straight)</b>		For attaching appliqué on tubular pieces of fabric and mitering corners	—	—	—	—	NO
	<b>Sideways to left (Straight)</b>		For attaching appliqué on tubular pieces of fabric	—	—	—	—	NO
	<b>Sideways to right (Straight)</b>		For attaching appliqué on tubular pieces of fabric	—	—	—	—	NO
	<b>Diagonally left down (Straight)</b>		For attaching appliqué on tubular pieces of fabric and mitering corners	—	—	—	—	NO
	<b>Forward (Straight)</b>		For attaching appliqué on tubular pieces of fabric and mitering corners	—	—	—	—	NO
	<b>Diagonally right down (Straight)</b>		For attaching appliqué on tubular pieces of fabric and mitering corners	—	—	—	—	NO
	<b>Sideways to left (Zigzag)</b>		For attaching appliqué on tubular pieces of fabric	—	—	—	—	NO
	<b>Sideways to right (Zigzag)</b>		For attaching appliqué on tubular pieces of fabric	—	—	—	—	NO
	<b>Forward (Zigzag)</b>		For attaching appliqué on tubular pieces of fabric and mitering corners	—	—	—	—	NO
	<b>Reverse (Zigzag)</b>		For attaching appliqué on tubular pieces of fabric and mitering corners	—	—	—	—	NO



## INDEX

- A**
- accessories ..... 11
  - air vent ..... 9
  - alarm ..... 196
  - alphabet patterns
    - character/decorative stitches ..... 95
  - alternate bobbin case ..... 13, 141
  - appliqués ..... 61, 68, 72, 162, 163
  - array key ..... 173
  - arrow keys ..... 135, 171, 181
  - attaching elastic tape ..... 62, 76
  - automatic reverse/reinforcement stitching ..... 46
  - automatic thread cutting key ..... 46
- B**
- bar tacks ..... 84
  - basting ..... 57
  - blind hem stitch ..... 71
  - bobbin ..... 24, 27, 28
  - bobbin center pin ..... 13, 141
  - bobbin cover ..... 10, 27
  - bobbin holder ..... 25
  - bobbin thread
    - pulling up ..... 28
    - replacing ..... 145
    - setting ..... 27
    - winding ..... 24
  - bobbin winder ..... 9
  - bobbin winding pretension disk and guide ..... 9, 25, 27
  - button sewing ..... 86
  - buttonhole lever ..... 10, 81, 84
  - buttonhole stitches ..... 79
- C**
- carriage ..... 10
  - character/decorative stitches
    - adjusting ..... 98
    - combining ..... 104
    - editing ..... 100
    - key functions ..... 100
    - retrieving ..... 115, 116, 117
    - saving ..... 112, 113, 114
    - selecting ..... 94
    - sewing ..... 97
    - stitch selection screens ..... 94
  - cleaning ..... 184
  - combining
    - character/decorative stitches ..... 104
    - embroidery edit ..... 179
  - crazy quilts ..... 62
- D**
- daisy stitch ..... 77
  - darning ..... 83
  - darts ..... 58
  - delete key ..... 173
  - drawn work ..... 77, 78
- E**
- edit end key ..... 178
  - editing
    - character/decorative stitches ..... 100
    - embroidery ..... 134
    - embroidery edit ..... 170
  - elastic zigzag stitches ..... 62
  - elongation key ..... 101
  - embroidery
    - automatic thread cutting ..... 150
    - edges or corners ..... 132
    - key functions ..... 128
    - restarting from the beginning ..... 147
    - ribbons or tape ..... 132
    - selecting patterns ..... 124
    - sewing speed ..... 151
    - small fabrics ..... 132
    - thread color display ..... 151
  - embroidery card slot ..... 9, 127
  - embroidery cards ..... 14, 127
  - embroidery edit
    - combining ..... 179, 182
    - function descriptions ..... 166
  - embroidery foot "U" ..... 11, 121
  - embroidery foot height ..... 129
  - embroidery frame
    - attaching/removing ..... 133
    - hooping ..... 131
    - type ..... 130
    - using the embroidery sheet ..... 131
  - embroidery frame display ..... 134
  - embroidery needle plate cover ..... 142
  - embroidery patterns
    - appliqués from frame patterns ..... 162, 163
    - checking embroidering position ..... 139
    - combining ..... 179
    - deleting ..... 173
    - editing ..... 170
    - pattern selection screens ..... 124
    - retrieving ..... 158, 159, 160
    - saving ..... 155, 156, 157
    - selecting ..... 124, 167
    - sewing ..... 141
  - embroidery sheet ..... 131
  - embroidery speed ..... 20, 151
  - embroidery unit ..... 122
    - carriage ..... 10, 122
  - error messages ..... 191
  - eyelets ..... 87
- F**
- fabrics
    - fabric/thread/needle combinations ..... 37
    - sewing heavyweight fabric ..... 43
    - sewing lightweight fabric ..... 43
    - sewing stretch fabrics ..... 82
  - fagoting ..... 75
  - feed dog position switch ..... 9, 70, 86
  - feed dogs ..... 10, 70, 86
  - flat fell seams ..... 59
  - flatbed attachment with accessory compartment ..... 9, 11, 122
  - Foot controller ..... 9, 41
  - foot controller jack ..... 9
  - forward/back key ..... 146, 147
  - frame-securing lever ..... 10, 133
- H**
- handle ..... 9
  - handwheel ..... 9
  - hard case ..... 13
  - heirloom stitching ..... 77
  - horizontal mirror image key ..... 101, 137

**I**

image key ..... 51, 95, 96, 140

**K**

## key functions

character/decorative stitches ..... 100  
embroidering ..... 128  
utility stitches ..... 18

knee lifter ..... 9, 42

knee lifter slot ..... 9

**L**

languages ..... 21

LCD ..... 9, 17

**M**

machine operation mode key ..... 22

machine setting mode key ..... 20, 151, 152

main power switch ..... 9, 16

maintenance ..... 184

## memory

character/decorative ..... 110

embroidery ..... 153

utility ..... 52

mirror image key ..... 51

multi color key ..... 138, 174

multi-directional sewing ..... 88

**N**

## needle

changing the position ..... 55

fabric/thread/needle combinations ..... 37

replacing ..... 35

settings ..... 17

twin needle ..... 32

needle bar thread guide ..... 10, 30, 32

needle clamp screw ..... 10

needle mode selection key (single/twin) ..... 32, 33

needle plate ..... 10

needle plate cover ..... 10, 184

needle position ..... 55

needle position button ..... 11

needle threader lever ..... 9, 31

**O**

operation buttons ..... 9, 11

options ..... 14

overcasting ..... 61, 62, 63

**P**

patchwork ..... 62

pattern explanation key ..... 23

pattern selection key ..... 173

pattern selection screen ..... 124, 167

piecing ..... 67

pin tucks ..... 60

power cord ..... 16

presser foot ..... 10

replacing ..... 34

presser foot code ..... 17, 128

presser foot holder ..... 10, 34

presser foot lever ..... 9, 43

presser foot lifter button ..... 11, 133

presser foot/needle exchange key ..... 32, 34, 35, 121

pretension disk ..... 25, 27

prewound bobbins ..... 141

**Q**

quilting ..... 67

free-motion ..... 70

**R**

reinforcement stitching ..... 42, 46

## retrieving

character/decorative stitches ..... 115

embroidery patterns ..... 158

from computer ..... 117, 160

from machine ..... 115, 158

from USB media ..... 116, 159

reverse stitching ..... 42, 46, 54

reverse/reinforcement stitch button ..... 11, 42

rotate key ..... 135, 171

**S**

satin stitching ..... 69

## saving

character/decorative stitches ..... 112

computer ..... 114, 157

embroidery patterns ..... 155

machine's memory ..... 112, 155

USB media ..... 113, 156

utility stitches ..... 52

scalloping ..... 73

## screen

adjusting ..... 21, 186

locking ..... 47

securing stitching ..... 42

## settings

automatic reverse/reinforcement stitching ..... 46

automatic thread cutting ..... 46, 150

LCD density ..... 21, 186

stitch length ..... 44

thread tension ..... 45, 149

zigzag width ..... 44

sewing speed controller ..... 9, 11, 40

sewing type selection key ..... 53

shell tuck stitching ..... 73

side cutter ..... 65

single/repeat sewing key ..... 102

size key ..... 101, 136, 172

smocking ..... 74

spacing key ..... 174

specifications ..... 197

spool cap ..... 9

spool net ..... 13

spool pin ..... 9

stabilizer ..... 129

start/stop button ..... 11, 40

step patterns ..... 108

stitch length ..... 44

stitch width ..... 44

stitching density ..... 102, 138

straight stitch ..... 54

supplemental spool pin ..... 9, 24, 32

**T**

## thread

fabric/thread/needle combinations ..... 37

thread color display ..... 151

thread cutter ..... 9, 31

thread cutter button ..... 11, 41, 47

thread density key ..... 102

thread guide ..... 9, 25, 27, 32

thread guide plate ..... 9, 26, 30, 33

thread settings key ..... 138, 150

thread take-up lever check window ..... 9, 30

thread tension ..... 45, 149

top cover ..... 9

top stitching .....	74
touch pen .....	13, 187
holder .....	9
trial key .....	139

## U

---

upgrading .....	198
upper threading .....	29
twin needle .....	32
USB media	
retrieving .....	116, 159
saving .....	113, 156
usable .....	110, 153
USB port connector	
for computer .....	9, 114, 157
for media .....	9, 113, 156
utility stitches	
key functions .....	18
pattern explanation key .....	23
saving .....	52
selecting a stitch pattern .....	51
sewing .....	40
sewing type selection key .....	53
stitch selection screens .....	50
stitch setting chart .....	201

## V

---

vertical mirror image key .....	101
---------------------------------	-----

## W

---

walking foot .....	68
--------------------	----

## Z

---

zigzag stitch .....	61
stitch width .....	44
zipper insertion .....	89





