



b79



bernette

SWISS DESIGN



# Table of Contents

<b>IMPORTANT SAFETY INSTRUCTIONS .....</b>	<b>5</b>	2.7 Presser foot .....	28
<b>Important information .....</b>	<b>7</b>	Adjusting the presser position via the knee lifter of the Free Hand System .....	28
Explanation of symbols .....	7	Changing the presser foot sole .....	28
<b>1 My bernette .....</b>	<b>9</b>	Having the presser foot sole displayed in the user interface .....	29
1.1 Overview Machine .....	9	Adjusting the presser foot pressure .....	30
Overview front controls .....	9	2.8 Needle and stitch plate .....	30
Overview front .....	12	Changing the needle .....	30
Overview top .....	13	Selecting the needle in the User Interface .....	31
Overview back .....	14	Needle stop up/down (permanent) .....	31
1.2 Accessory .....	15	Changing the stitch plate .....	32
Included accessories .....	15	Checking the stitch plate in the user interface .....	32
Overview presser feet .....	16	2.9 Threading .....	33
1.3 Overview User Interface .....	17	Threading preparation .....	33
Overview System settings .....	17	Threading the upper thread .....	33
Overview functions/visual information .....	18	Threading the double needle .....	37
Overview Functions and Views .....	18	Winding the bobbin thread .....	38
1.4 Needle, Thread, Fabric .....	19	Threading the bobbin thread .....	39
Overview Needles .....	19	<b>3 Setup Program .....</b>	<b>41</b>
Example for needle description .....	21	3.1 Sewing settings .....	41
Thread selection .....	21	Adjusting the upper thread tension .....	41
Needle/thread combination .....	22	Adjusting the maximum sewing speed .....	41
<b>2 Sewing preparation .....</b>	<b>23</b>	Programming the securing stitches .....	41
2.1 Connection and Switching on .....	23	Adjusting the hovering height of the presser foot .....	42
Connecting the machine .....	23	Programming the button «Securing» .....	42
Use of the power cable (only USA/Canada) .....	23	Programming the button «Thread cutter» .....	43
Connecting the foot control .....	23	Adjusting the presser foot position with needle stop down .....	43
Attaching the knee lifter of the Free Hand System .....	23	Programming the button «Quick reverse» .....	44
Switching the machine on .....	24	Programming the foot control individually .....	44
Fixing the touchscreen pen .....	24	Fabric thickness measurement .....	45
Regulating the speed via the foot control .....	24	Adjusting the general balance .....	45
Raising/Lowering the needle .....	25	3.2 Embroidery settings .....	45
Programming the foot control individually .....	25	Adjusting the upper thread tension .....	45
2.2 Spool pin .....	25	Adjusting the maximum embroidering speed .....	46
Horizontal spool pin .....	25	Calibrating the embroidery hoop .....	46
Second spool pin .....	26	Deactivating securing stitches .....	46
2.3 Free arm .....	26	Adjusting the thread cut .....	47
2.4 Sewing table and accessory box .....	27	Adjusting the height of the embroidery presser foot .....	47
2.5 Raising or Lowering the Feed dog .....	27	3.3 Selecting personal settings .....	48
2.6 Using the slide-on table .....	27	3.4 Monitoring functions .....	48
		Activating the upper thread indicator .....	48
		Activating the bobbin thread indicator .....	48

## Table of Contents

3.5	Sound on/off .....	49	5.7	Administering stitch patterns .....	65
3.6	Machine settings .....	49		Saving stitch patterns in personal memory .....	65
	Adjusting the brightness of the display .....	49		Overwriting stitch patterns from the personal memory .....	65
	Adjusting the sewing light .....	49		Loading stitch patterns from the personal memory .....	66
	Calibrating the display .....	49		Deleting stitch patterns from the personal memory .....	66
	Back to default setting .....	50	<b>6</b>	<b>Practical stitches .....</b>	<b>67</b>
	Updating the machine Firmware .....	50	6.1	Overview Practical stitches .....	67
	Checking the firmware version .....	51	6.2	Sewing straight stitch .....	69
	Reviewing the total number of stitches .....	51	6.3	Securing with the automatic Securing Program .....	69
	Selecting a language .....	51	6.4	Sewing in the zipper .....	70
<b>4</b>	<b>System settings .....</b>	<b>52</b>	6.5	Sewing Triple straight stitch .....	71
4.1	Calling up the Tutorial .....	52	6.6	Sewing Triple zigzag .....	71
4.2	Using eco mode .....	52	6.7	Manual darning .....	72
4.3	Calling up the Creative Consultant .....	52	6.8	Automatic darning and Reinforced darning .....	72
4.4	Cancelling any alterations with «clr» .....	54	6.9	Finishing edges .....	74
<b>5</b>	<b>Creative sewing .....</b>	<b>55</b>	6.10	Sewing Double overlock .....	74
5.1	Overview selection menu sewing .....	55	6.11	Sewing Vari overlock .....	75
	Selecting a stitch pattern .....	55	6.12	Edgestitching using the seam guide .....	75
5.2	Dual Feed (DF) .....	56	6.13	Sewing narrow hemming .....	76
	Application of the Dual Feed .....	56	6.14	Sewing blind hems .....	76
	Use the Dual Feed .....	56	6.15	Sewing visible hems .....	77
5.3	Regulating the speed .....	57	6.16	Sewing basting stitches .....	78
5.4	Adjusting the upper thread tension .....	57	6.17	Sew thick areas .....	78
5.5	Editing stitch patterns .....	57	6.18	Sewing Corners .....	79
	Changing the stitch width .....	57	<b>7</b>	<b>Decorative stitches .....</b>	<b>80</b>
	Changing the stitch length .....	58	7.1	Overview Decorative Stitches .....	80
	Correcting the balance .....	58	7.2	Altering the stitch density .....	81
	Programming pattern repeat .....	59	7.3	Sewing cross stitches .....	81
	Mirror image of stitch patterns .....	59	<b>8</b>	<b>Alphabets .....</b>	<b>82</b>
	Editing stitch pattern length .....	59	8.1	Overview Alphabet .....	82
	Permanent Quick reverse .....	60	8.2	Creating lettering .....	82
	Backstepping .....	60	<b>9</b>	<b>Buttonholes .....</b>	<b>84</b>
5.6	Combining stitch patterns .....	60	9.1	Overview Buttonholes .....	84
	Overview Combi mode .....	60	9.2	Marking buttonholes .....	85
	Creating Stitch pattern combinations .....	61	9.3	Sewing a buttonhole automatically .....	86
	Editing a single stitch pattern .....	61	9.4	Reinforce buttonhole .....	88
	Deleting a single stitch pattern .....	62	9.5	Sewing on buttons .....	88
	Adding a single stitch pattern .....	62	9.6	Sewing eyelets .....	90
	Mirroring a stitch pattern combination .....	63			
	Programming pattern repeat .....	63			
	Securing a stitch pattern combination .....	64			
	Saving a stitch pattern combination .....	64			
	Loading a stitch pattern combination .....	64			
	Overwriting a stitch pattern combination .....	64			
	Deleting a stitch pattern combination .....	65			

<b>10 Quilting</b> .....	<b>91</b>	13.5 Embroidery hoop .....	108
10.1 Overview Quilt Stitches .....	91	Overview embroidery hoop selection .....	108
10.2 Quilting, Securing Program .....	92	Selecting the embroidery hoop .....	108
10.3 Sewing handlook quilt stitches .....	92	Tear-away stabilizers .....	109
10.4 Guiding the quilt work freely .....	93	Cut-away stabilizers .....	109
<b>11 Stitch Designer</b> .....	<b>94</b>	Using adhesive spray .....	109
11.1 Overview Stitch Designer .....	94	Using spray starch .....	109
11.2 Creating your own stitch pattern .....	94	Using iron-on interfacing .....	109
Creating stitch designs using screen dots .....	95	Using paper-backed adhesive stabilizer .....	109
Free hand drawing .....	95	Using water-soluble stabilizer .....	110
11.3 Editing the view .....	95	Preparing the embroidery hoop .....	110
11.4 Inserting points .....	95	Attaching the hoop .....	112
11.5 Relocating the points .....	95	Overview Embroidery functions .....	113
11.6 Duplicating points .....	96	Locating the center of the embroidery motif .....	113
11.7 Deleting points .....	96	Center the needle to the embroidery hoop .....	114
11.8 Activating the triple stitch .....	97	Embroidery arm return .....	114
<b>12 My bernette Embroidery</b> .....	<b>98</b>	Grid on/off .....	114
12.1 Overview Embroidery module .....	98	<b>14 Creative embroidering</b> .....	<b>115</b>
12.2 Overview User Interface .....	99	14.1 Overview embroidering .....	115
Overview functions/visual information .....	99	14.2 Selecting and changing the embroidery motif .....	115
Overview System settings .....	99	14.3 Checking the embroidery time and the embroidery motif size .....	115
Overview Selection menu embroidery .....	100	14.4 Regulating the speed .....	115
12.3 Important Embroidery information .....	100	14.5 Editing the embroidery motif .....	116
Upper thread .....	100	Overview Editing embroidery motif .....	116
Bobbin thread .....	100	Scaling up the embroidery motif view .....	116
Choosing the embroidery motif .....	101	Downsizing the embroidery motif .....	116
Embroidery test .....	101	Moving the embroidery motif view .....	117
Embroidering motifs by third-party providers .....	101	Moving the embroidery motif in enlarged view .....	117
Underlay stitches .....	101	Moving the embroidery motif .....	117
The size of the embroidery motif .....	102	Rotating motif .....	118
Satin or Leaf stich .....	102	Altering the embroidery motif size proportionally .....	118
Step stitch .....	102	Mirroring embroidery motifs .....	118
Connecting stitches .....	103	Checking the size and the position of the embroidery motif .....	119
<b>13 Embroidering preparation</b> .....	<b>104</b>	Deleting an embroidery motif .....	119
13.1 Attaching the Module .....	104	14.6 Creating lettering .....	120
13.2 Embroidery foot .....	104	Overview embroidery alphabets .....	120
Attaching the embroidery foot .....	104	Creating words/sentences .....	120
13.3 Needle and stitch plate .....	106	Editing words/sentences .....	121
Inserting the embroidery needle .....	106	Bending the text .....	122
Attaching the stitch plate (CutWork/Straight) .....	106	Altering the stitch density .....	122
13.4 Selecting the embroidery motif .....	107	14.7 Combining embroidery motifs .....	123
		Combining embroidery motifs .....	123
		Deleting a single embroidery motif .....	123

## Table of Contents

14.8	Changing the colors of the embroidery motif .....	124		
	Overview changing the color .....	124		
	Changing the colors .....	124		
	Changing the thread brand .....	125		
14.9	Embroidering the embroidery motif .....	125		
	Overview Embroidery menu .....	125		
	Adding basting stitches .....	126		
	Moving the hoop .....	126		
	Embroidery sequence control when thread breaks .....	126		
	Cutting connecting stitches .....	127		
	Multi-colored embroidery motif on/off .....	127		
	Color indication .....	127		
14.10	Administering embroidery motifs .....	128		
	Administering embroidery motifs .....	128		
	Saving embroidery motifs in the personal memory .....	128		
	Saving the embroidery motif on the USB stick .....	128		
	Overwriting the embroidery motif in the personal memory .....	129		
	Loading an embroidery motif from the personal memory .....	129		
	Loading an embroidery motif from the USB stick .....	129		
	Deleting an embroidery motif from the personal memory .....	129		
	Deleting an embroidery motif from the USB stick .....	130		
<b>15</b>	<b>Embroidery .....</b>	<b>131</b>		
15.1	Embroidering via the button «Start/Stop» .....	131		
15.2	Adjusting the upper thread tension .....	131		
<b>16</b>	<b>BERNINA CutWork Tool .....</b>	<b>133</b>		
16.1	Changing the CutWork Tool .....	133		
16.2	Start to cut .....	134		
<b>17</b>	<b>Appendix .....</b>	<b>135</b>		
17.1	Maintenacnce and cleaning .....	135		
	Cleaning the display .....	135		
	Cleaning the feed dog .....	135		
	Cleaning the hook .....	136		
	Oiling the needle bar .....	137		
17.2	Troubleshooting .....	138		
17.3	Error messages .....	140		
17.4	Storage and disposal .....	145		
	Storing the machine .....	145		
	Dispose of the machine .....	145		
17.5	Technical data .....	145		
<b>18</b>	<b>Overview stitch patterns .....</b>	<b>146</b>		
18.1	Overview Stitch patterns .....	146		
	Practical stitches .....	146		
	Buttonholes .....	146		
	Decorative stitches .....	146		
	Quilt stitches .....	148		
18.2	Overview Embroidery motifs .....	149		
	Editing the embroidery motif .....	149		
	Embellishment .....	149		
	Quilt motifs .....	151		
	Borders and Lace .....	153		
	Children .....	154		
	Flowers .....	155		
	Seasons .....	157		
	Asia .....	159		
	Sport/Hobby .....	160		
	Animals .....	162		
	Cutwork .....	164		
	Campaign .....	165		
	<b>Index .....</b>	<b>166</b>		

# IMPORTANT SAFETY INSTRUCTIONS

Please be aware of the following basic safety instructions when using your machine. Before using this machine, read instruction manual carefully.

## DANGER!

To reduce the risk of electrical shock:

- Never leave the machine unattended as long as it is plugged in.
- Always unplug the machine from the electrical outlet immediately after using.

Protection against LED radiation:

- Do not view the LED light directly with optical instruments (e.g. magnifier). The LED light corresponds with protection class 1M.
- When the LED light is damaged or defective, contact your bernette specialist dealer.

## WARNING

To reduce the risk of burns, fire, electric shock or injury to persons:

- To operate the machine always use the supplied power cable. USA and Canada only: Do not connect power plug NEMA 1-15 to circuits exceeding 150 volt-to-ground.
- Use this machine only for purposes as described in this manual.
- Only use the machine in dry rooms.
- Do not use the machine in a damp condition or in a damp environment.
- Do not use this machine as a toy. Close attention is necessary when this machine is used by or near children.
- The machine can be used by children older than 8 or by people with reduced physical, sensory or mental capabilities or if there is a lack of experience and knowledge how to operate the machine as long as they are supervised or have been given instruction concerning the responsible use of the appliance and are aware of the involved risks.
- Children are not allowed to play with this machine.
- Cleaning and maintenance work must not be carried out by children unless they are supervised.
- Never operate this machine if it has a damaged cord or plug, if it is not working properly, if it has been dropped or damaged, or dropped into water. Contact the nearest authorized bernette dealer to arrange further details.

- Only use accessory recommended by the manufacturer.
- Don't use this machine when the ventilation openings are blocked. Keep the ventilation openings and the foot control free from the accumulation of lint, dust and loose cloth.
- Never insert any objects into any openings of the machine.
- Do not place any objects on the foot control.
- Always use the machine with a foot control of this type FC-210.
- Do not operate the machine where aerosol products (sprays) or oxygen are being used.
- Keep fingers away from all moving parts. Special care is required around the needle.
- Neither pull nor push the fabric while sewing. This can cause needle breakage.
- When making any adjustments in the needle area – such as such as threading the needle, changing the needle, threading the hook or changing the presser foot – turn power switch to «0».
- Do not use bent needles.
- Always use the original bernette stitch plate. The wrong stitch plate can cause needle breakage.
- To disconnect, turn power switch to «0» and then remove the plug from the outlet. Do not unplug by pulling the cord, instead grasp the plug to pull it from the outlet.
- Always disconnect the power plug from the electrical outlet when the covers are removed or opened, when the machine is lubricated or during any other maintenance adjustments mentioned in the instruction manual.
- This machine is provided with double insulation (except USA, Canada and Japan). Use only identical replacement parts. See instructions for Servicing of double-insulated products.
- The sound pressure level is lower than 70 dB(A) under normal conditions.



## Important information

### Availability of the digital manual

The instruction manual of the machine are provided exclusively as a PDF.


- > Select «www.mybernette.com» in the Internet Browser.
- > Select the desired machine model.
- > Download the instruction manual under «Download».

### Appropriate use

Your bernette machine is conceived and designed for private household use. It is intended for sewing fabrics and other materials as described in this instruction manual. Any other use is not considered proper. bernette assumes no liability concerning consequences resulting from an inappropriate usage.

### Maintenance of double-insulated products

In a double-insulated product, two systems of insulation are provided instead of grounding. No grounding means is provided on a double-insulated product nor should a means for grounded be added to the product. Servicing a double-insulated product requires extreme care and knowledge of the system and should only be done by qualified service personnel. Only original spare parts should be used for service and repairs. A double-insulated product is marked with the words: «Double-Insulation »or «double-insulated».

 The symbol may also be marked on the product.

### Environmental Protection

BERNINA is committed to the protection of the environment. We strive to minimize the environmental impact of our products by continuously improving product design and our technology of manufacturing.



The machine is labeled with the symbol of the crossed-out wastebin. This means that the machine must not be disposed of with the household waste when the machine is no longer needed. Improper disposal can result in dangerous substances getting into the groundwater and thus into our food chain, damaging our health.

The machine must be returned free of charge to a nearby collection point for waste electrical and electronic equipment or to a collection point for the reuse of the machine. Information on the collection points can be obtained from your local administration. When purchasing a new machine, the dealer is obliged to take back the old machine free of charge and dispose of it properly.

If the machine contains personal data, you are responsible for deleting the data yourself before returning the machine.

### Explanation of symbols



Labels a high-risk hazard which can lead to serious injuries or potentially even death if not avoided.



Labels a medium-risk hazard which can lead to serious injuries if not avoided.



Labels a low-risk hazard which can lead to minor or moderate injuries if not avoided.

NOTICE

---

Labels a hazard which can lead to material damage if not avoided.

---

Example images are used in these operating instructions for the purposes of illustration. The machines shown in the images and the accessories shown therefore do not always match the actual items included with your machine.

# 1 My bernette






## 1.1 Overview Machine



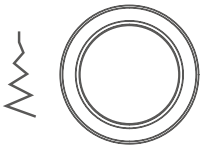
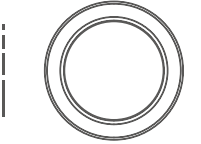
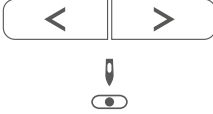
### Overview front controls



- |   |                      |    |                            |
|---|----------------------|----|----------------------------|
| 1 | Quick reverse        | 6  | Securing                   |
| 2 | Thread cutter        | 7  | Needle up/down             |
| 3 | Presser foot up/down | 8  | Upper Multifunctional knob |
| 4 | Start/Stop           | 9  | Lower Multifunctional knob |
| 5 | Slide speed control  | 10 | Needle left/right          |

## Operation buttons

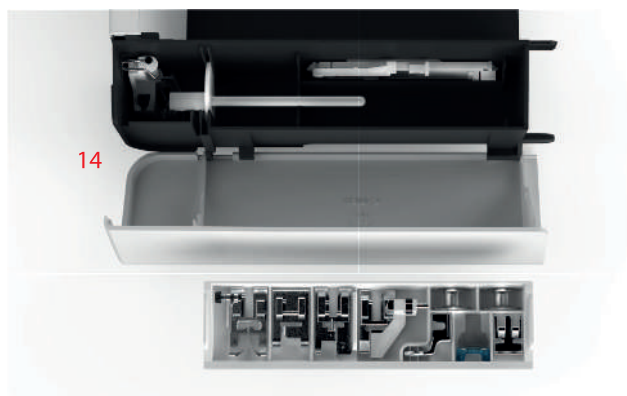
Number	Buttons	Name	Purpose
1		Quick reverse	<ul style="list-style-type: none"> <li>&gt; «Keep Quick reverse »pressed to sew in reverse.</li> <li>&gt; Touch the icon «Quick reverse» to sew permanently in reverse.</li> </ul> <p>«Quick reverse» doesn't work with the stitch patterns 22-24 and with the buttonhole patterns 51-71.</p>
2		Thread cutter	<ul style="list-style-type: none"> <li>&gt; Press the «Thread cutter» button in order to cut the upper and lower threads automatically.</li> </ul> <p>2-6 securing stitches can be programmed in the Setup-Program. These are sewn before the thread is cut.</p>
3		Presser foot up/down	<ul style="list-style-type: none"> <li>&gt; Press the button «Presser foot up/down »to raise the presser foot into hovering position.</li> <li>&gt; Push the button «Presser foot up/down» to raise the presser foot.</li> </ul>
4		Start/Stop	<p>The button «Start/Stop» serves the purpose to change the presser foot position and to start the machine.</p> <ul style="list-style-type: none"> <li>&gt; To start the machine, keep the button «Start/Stop» pressed for 2 seconds.</li> </ul> <p><b>Sewing mode</b></p> <ul style="list-style-type: none"> <li>&gt; Press the button «Presser foot up/down» to raise the presser foot into hovering position.</li> </ul> <p><b>Embroidery mode</b></p> <ul style="list-style-type: none"> <li>&gt; To bring the presser foot to its highest position, quickly press «Start/Stop» in the embroidery mode.</li> <li>&gt; Press the button «Presser foot up/down» again to move the presser foot into hovering position.</li> </ul>
5		Slide speed control	<p>The sewing speed can be adjusted infinitely variable with the slide.</p> <ul style="list-style-type: none"> <li>&gt; Move the slide to the left to reduce the sewing speed.</li> <li>&gt; Move the slide to the right to increase the sewing speed.</li> </ul>

Number	Buttons	Name	Purpose
6		Securing	<p>The function «Securing at sewing start» is activated in the Setup by default and can be deactivated by pressing the button «Securing».</p> <p>When the function «Securing at sewing start» is not activated in the Setup, it can be programmed by pressing the button «Securing».</p> <p>A securing icon which appears on the display during sewing indicates that the function is activated.</p> <p>The number of securing stitches can be programmed in the Setup-Program.</p> <ul style="list-style-type: none"> <li>&gt; To sew the securing stitches first, press the button «Securing» before you start sewing.</li> <li>&gt; To sew the securing stitches at the pattern end, press the button «Securing» while sewing.</li> <li>&gt; To sew securing stitches within a stitch pattern combination, press the button «Securing». <ul style="list-style-type: none"> <li>– The selected pattern of the combination is secured according to the setting.</li> </ul> </li> </ul>
7		Needle up/down	<ul style="list-style-type: none"> <li>&gt; Push the button «Needle up/down» to lower the needle.</li> <li>&gt; Push the «Needle up/down» button again to raise the needle.</li> </ul>
8		Upper Multifunction knob	With the «Upper Multifunction knob» setting values can be changed in the sewing, the embroidering and the Setup Program.
9		Lower Multifunction knob	With the «Lower Multifunction knob» setting values can be changed in the sewing, the embroidering and the Setup Program.
10		Needle left/right	<p>There is a total of 15 needle positions. The needle position is indicated by the needle position number in the display.</p> <ul style="list-style-type: none"> <li>&gt; Press the «Needle left» button to move the needle to the left.</li> <li>&gt; Press the «Needle right» button to move the needle to the right.</li> </ul>

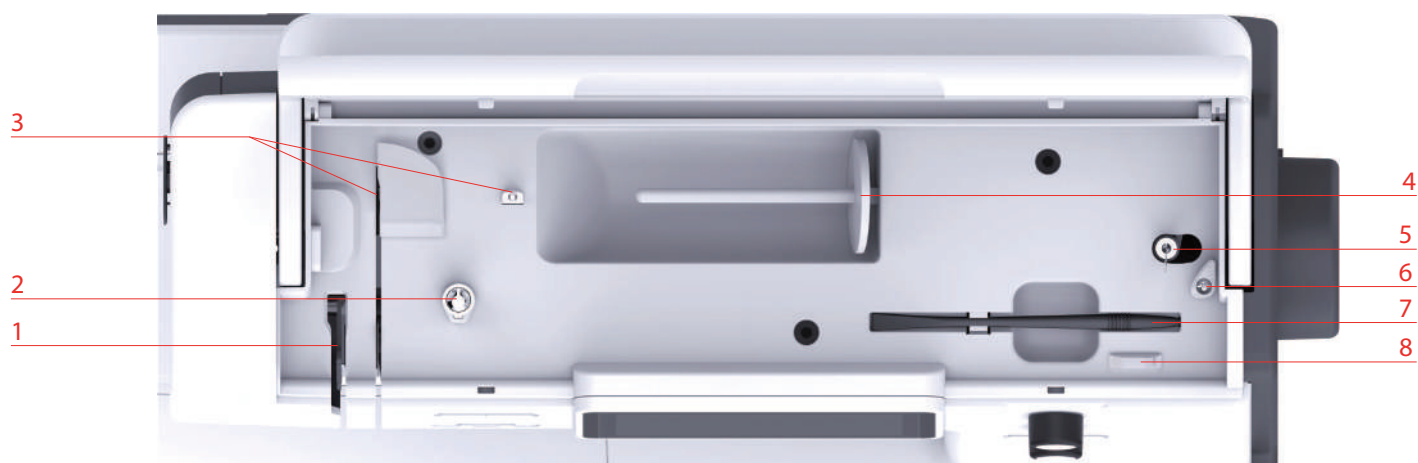
## Overview front



- |   |                                  |    |                                 |
|---|----------------------------------|----|---------------------------------|
| 1 | Feed dog lever                   | 8  | Buttonhole lever                |
| 2 | Connection for embroidery module | 9  | Thread cutter                   |
| 3 | Stitch plate cover               | 10 | Thread take-up lever            |
| 4 | Stitch plate                     | 11 | Top cover                       |
| 5 | Presser foot                     | 12 | LCD Display                     |
| 6 | Sewing light                     | 13 | Connection for Free Hand System |
| 7 | Needle threader                  | 14 | Sewing table and accessory box  |



### Overview top



- 1 Thread take-up lever
- 2 Thread pretension
- 3 Thread guide
- 4 Spool pin

- 5 Winding unit and holder for second spool pin
- 6 Stopper winding unit
- 7 Touchscreen pen
- 8 Thread cutter

## Overview back



- 1 Connection for power cable
- 2 Air vents
- 3 Connection for foot control
- 4 USB port
- 5 Power switch

- 6 Handwheel
- 7 Carrying handle
- 8 Air vents
- 9 Dual Feed
- 10 Sewing table and accessory box



## 1.2 Accessory

**All rights reserved:** For technical reasons and for the purpose of product improvements, changes concerning the features of the machine can be made at any time and without advance notice. The supplied accessory can vary depending on the country of delivery.

### Included accessories

Visit [www.mybernette.com/accessories](http://www.mybernette.com/accessories) for more accessory information.






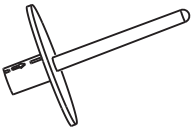
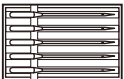

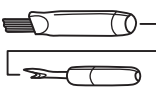


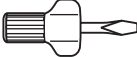

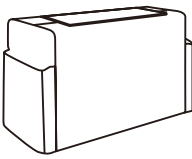

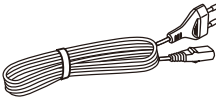
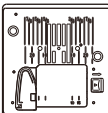
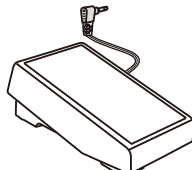
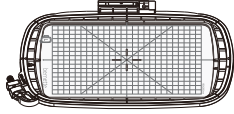
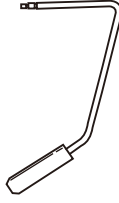
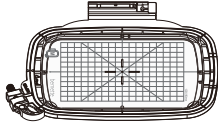

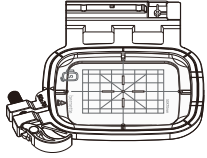
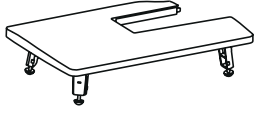
Figure	Name	Figure	Name
	Bobbin (3x)		Felt disc
	Spool net		Second spool pin
	Needle package (2x)		Touchscreen pen
	Brush and seam ripper		Seam guide
	Spool disc large		Screwdriver
	Spool disc medium		Soft Cover with pocket
	Spool disc small (2x)		Power cable
	CutWork/Straight stitch plate		Foot control

Figure	Name	Figure	Name
	Embroidery hoop large, 160 x 260 mm with embroidery template		Knee lifter
	Embroidery hoop medium, 120 x 180 mm with embroidery template		Lubricator
	Embroidery hoop small, 50 x 70 mm with embroidery template		Slide-on table

### Overview presser feet


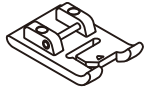
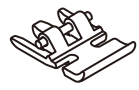
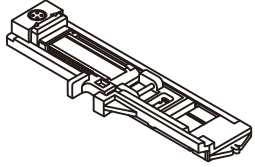
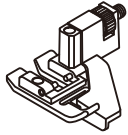

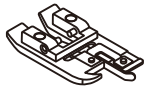
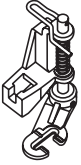
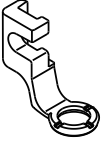
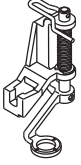
Illustration	Name	Purpose
	Zigzag foot (DA)	To sew practical, decorative stitches and hems.
	Embroidery foot (JK)	To sew buttonholes, appliqués and decorative stitches.
	Zipper foot (JB)	Used to sew with dual feed. To sew in zippers.
	Buttonhole foot with slide (RJ)	To sew buttonholes.
	Blindstitch foot (DM)	To sew blind-stitch hems with Dual Feed.
	Button-sew-on foot (RC)	To sew on button.
	Overlock foot (DI)	Used to sew with dual feed. Overlock stitches over the fabric edge.

Illustration	Name	Purpose
	Free motion foot (RX)	For embroidering, darning and free motion quilting.
	Embroidery foot (JL)	For embroidering, darning and free-motion quilting.
	Hopper embroidery foot (JX)	For embroidering, darning and free-motion quilting.

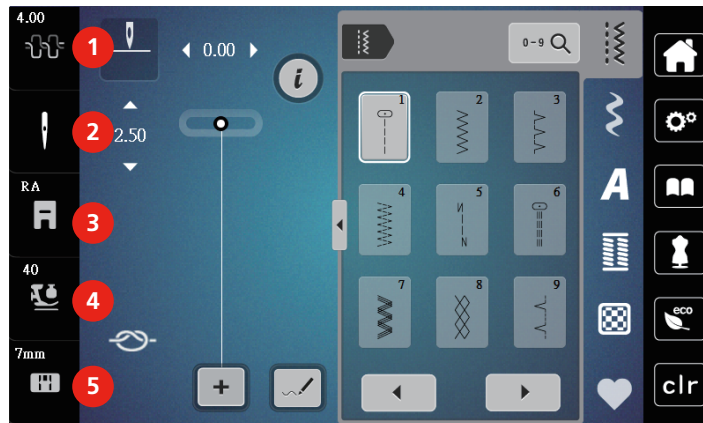
### 1.3 Overview User Interface

#### Overview System settings



- |   |               |   |                            |
|---|---------------|---|----------------------------|
| 1 | Home          | 4 | Creative Sewing Consultant |
| 2 | Setup Program | 5 | eco mode                   |
| 3 | Tutorial      | 6 | Back to default setting    |






## Overview functions/visual information



- |   |   |   |                        |
|---|---|---|------------------------|
| 1 | Upper thread tension                        | 4 | Presser foot pressure  |
| 2 | Needle selection                            | 5 | Stitch plate selection |
| 3 | Presser foot display/Presser foot selection |   |                        |

## Overview Functions and Views

Illustration	Name	Purpose
	Close	The display is closed and the previously made adjustments are saved.
	Icons «-/+»	By touching the icons «-» and «+» the setting values are changed.
	Confirm	Confirms the previously adjusted alterations. The display is closed.
	Cancel	The process is canceled. The display is closed and the previously made adjustments are not saved.
	Slide	By moving the slide the setting values are changed.
	Switch	Activates or deactivates functions.

Illustration	Name	Purpose
	Process navigation	With the process navigation, you can return from any display to the previous the display.
	Machine	To load or save motifs on the machine.
	USB stick	To load or save embroidery motifs on the USB stick.
	USB storage space	The percentage of used USB storage (%) will be displayed in the green bar icon.
	Swipe function	By swiping the display using the touchscreen pen or the finger upwards or downwards, further functions can be displayed.
	Yellow-framed icon	Touch the yellow-framed icon to reset the alterations to default setting.

## 1.4 Needle, Thread, Fabric

In the course of time a needle wears out. Therefore, the needle should be replaced regularly. Only a perfect point results in a good stitching result. In general it can be said: the thinner the thread, the finer the needle. The illustrated needles are either standard or optional accessory, depending on the machine.

- Needle sizes 70, 75: for light-weight fabrics.
- Needle sizes 80, 90: for medium fabrics.
- Needle sizes 100: for heavy fabrics.

### Overview Needles

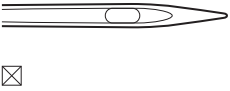
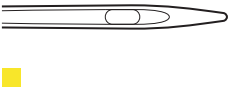
Illustration	Needle name	Needle description	Purpose
	<b>Universal needle</b> 130/705 H 60-120	Slightly rounded point	For nearly all natural and synthetic fabrics (woven and knitted).
	<b>Stretch needle</b> 130/705 H-S 75, 90	Mid-sized ball point, special eye shape and needle scarf	For jersey, tricot, knit and stretch fabrics.


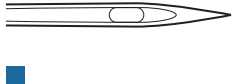
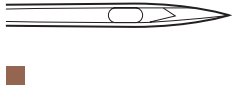
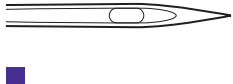


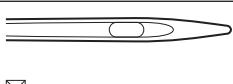








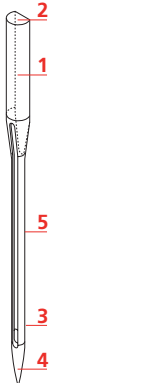
Illustration	Needle name	Needle description	Purpose
	<b>Jersey/Embroidery needle</b> 130/705 H SUK 60-100	Mid-sized ball point	For knitware, knitted good. For embroidering.
	<b>Jeans needle</b> 130/705 H-J 80-110	Point, narrow point, reinforced shaft	For heavy-weight fabrics such as jeans or canvas.
	<b>Leather needle</b> 130/705 H LR 90, 100	With cutting point (LR = special point to sew leather)	For all types of leather, synthetic leather, plastic, sheeting.
	<b>Microtex needle</b> 130/705 H-M 60-110	Especially sharp, narrow point	For micro fiber fabrics and silk.
	<b>Quilting needle</b> 130/705 H-Q 75, 90	Slightly rounded fine point	For straight and topstitching.
	<b>Embroidery needle</b> 130/705 H-E 75, 90	Small ball point, especially wide needle eye and wide thread groove	For embroidery on all natural and synthetic fabrics.
	<b>Fine-material needle</b> 130/705 H SES 70, 90	Small ball point	For fine knitware and knitted materials. For embroidery on fine, delicate fabrics.
	<b>Metafil needle</b> 130/705 H METAFIL 80	Long needle eye (2 mm) in all needle sizes	For sewing or embroidering with metallic threads.
	<b>Cordonnet needle (to patch embroidery)</b> 130/705 H-N 70-100	Long needle eye (2 mm) in all needle sizes	Topstitching with thick thread.
	<b>Felt needle</b> PUNCH	Needle with barbed hook	For felt work.
	<b>Hemstitch needle</b> 130/705 H WING 100-120	Wing-like widened needle shaft (wing)	To sew blind stitches.

Illustration	Needle name	Needle description	Purpose
 ☒	<b>Universal double needle</b>  130/705 H ZWI 70-100	Needle distance: 1.0/1.6/2.0/2.5/ 3.0/4.0/6.0/8.0	For visible hems in stretch fabrics, pintucks, decorative sewing.
 ☒	<b>Stretch double needle</b>  130/705 H-S ZWI 75	Needle distance: 2.5/4.0	For visible hems in stretch fabrics, pintucks, decorative sewing.
 ☒	<b>Hemstitch double needle</b>  130/705 H ZWIHO 100	Needle distance: 2.5	For special effects with hemstitch embroidery.
 ☒	<b>Universal triple needle</b>  130/705 H DRI 80	Needle distance: 3.0	For visible hems in stretch fabrics, decorative sewing.

### Example for needle description

The 130/705 system, which is the most common for household machines, is explained by the following picture of a Jersey/Stretch needle.

	<p><b>130/705 H-S/70</b></p> <p><b>130</b> = Shank length (1)</p> <p><b>705</b> = Flat shank (2)</p> <p><b>H</b> = Needle scarf (3)</p> <p><b>S</b> = Needle point (here medium ball point) (4)</p> <p><b>70</b> = Needle size 0.7 mm (5)</p>
---	---

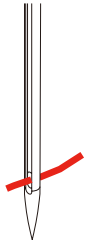
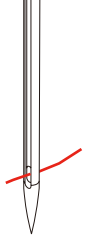
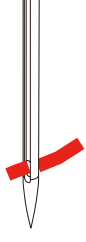
### Thread selection

For a perfect sewing result, thread and fabric quality play an important role.

We recommend purchasing quality threads to achieve good sewing results.

- Cotton threads have the advantage of being a natural fiber and therefore are especially suitable for sewing cotton fabrics.
- Mercerized cotton threads have a slight sheen that is not lost with washing.
- Polyester threads have a high tensile strength and is particularly colorfast.
- Polyester threads are more flexible and are recommended where a strong and elastic seam is required.
- Rayon threads are made of natural fibers and have a brilliant sheen.
- Rayon threads are suitable for decorative stitches and achieve a more beautiful effect.

### Needle/thread combination

	<p>The needle/thread combination is correct, when the thread fits perfectly into the long groove and goes easily through the needle eye. The thread can be optimally sewn.</p>
	<p>The thread can break and cause skipped stitches if there is too much play in the long groove or eye of the needle.</p>
	<p>The thread can break and become jammed if it frays on the edges of the long groove and is not guided optimally through the eye of the needle.</p>



## 2 Sewing preparation

### 2.1 Connection and Switching on

#### Connecting the machine

- > Insert the power cable into the power cord connection.



- > Insert the power cable into the power cord connection.

#### Use of the power cable (only USA/Canada)

The machine has a polarized plug (one blade wider than the other). To reduce the risk of electrical shock, this plug is intended to fit in a polarized outlet only one way. If the plug does not fit fully in the outlet, reverse the plug. If it still does not fit, contact a qualified electrician to install the proper outlet. Do not modify the plug in any way!

#### Connecting the foot control



- > Insert the cable of the foot control into the foot control connection.



#### Attaching the knee lifter of the Free Hand System

The presser foot may be raised and lowered with the Free Hand System. The knee lifter is extremely helpful when sewing appliqué, patchwork and quilting since it allows you to handle the fabric while your knee controls the presser foot.

- > Insert the knee lifter into the opening at the front side of the machine.

- > Adjust the sitting height so that the knee lifter can be operated with the knee.



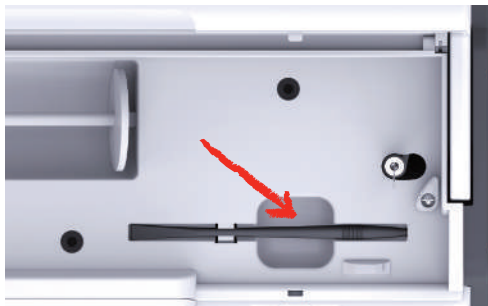
### Switching the machine on

- > Switch on the machine at the main switch to «I».



### Fixing the touchscreen pen

- > Store the touchscreen pen on the top holder.



### Regulating the speed via the foot control

Via the foot control the speed can be adjusted infinitely variable.

- > Press the foot control down carefully to start the machine.
- > To sew faster, press the foot control harder.
- > Release the foot control to stop the machine.



## Raising/Lowering the needle

- > Sink the heel back on the foot control to raise/lower the needle.



## Programming the foot control individually

The foot control can be programmed individually.

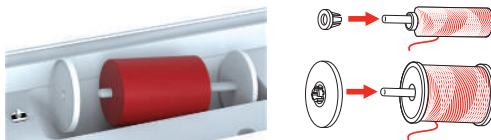
## 2.2 Spool pin

### Horizontal spool pin

Placing the thread spool and the thread disc

Spool discs hold the thread spool in place for proper release of thread from the spool. The thread disc is only used with the horizontal spool holder.

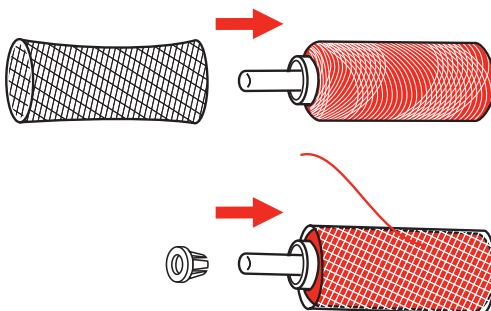
- > Place the thread spool on the spool holder.
- > Position the appropriate spool disc on the spool holder so that there is no space between the spool disc and the thread spool.



Using a spool net

The spool net provides an even unwinding of the thread from the thread spool and prevents the thread from knotting and breaking. The spool net is only used with the horizontal spool holder.

- > Pull the spool net over the thread spool.

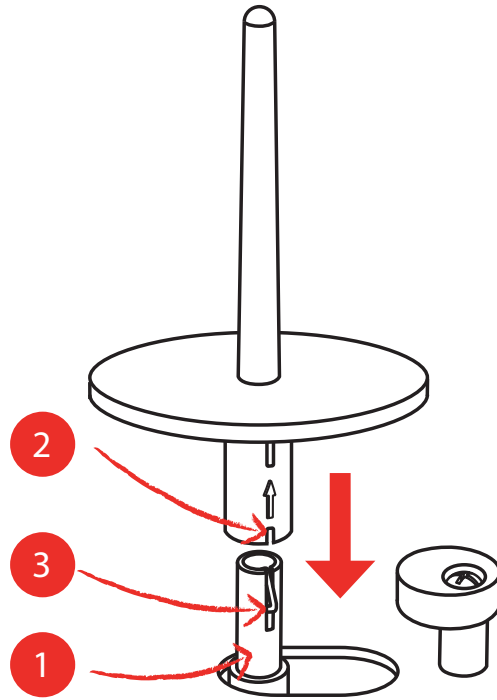


## Second spool pin

Installing the second spool pin

The second spool pin is necessary when several threads are sewn.

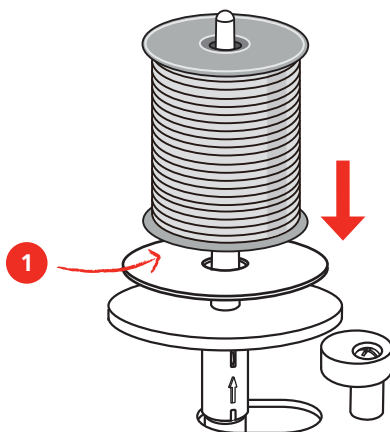
- > Insert the second spool pin onto the end of the bobbin winding unit(1).
- > Align the notch (2) with the spring (3) on the bobbin winding unit.



Inserting thread spool

The felt disc prevents the thread from getting hooked at the second spool pin.

- > Place the felt disc (1) on the second spool pin.
- > Place the thread spool on the second spool pin.



## 2.3 Free arm

The bernette b79 provides a solidly designed free arm which offers a lot of space for large project on the right of the needle.

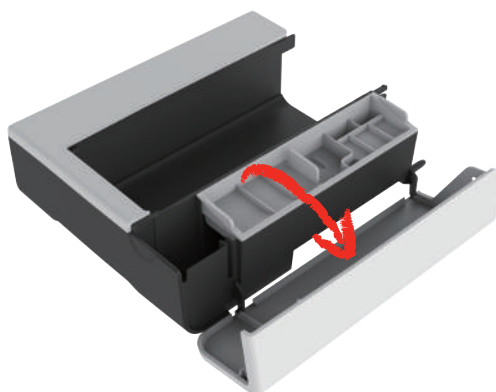
## 2.4 Sewing table and accessory box

The sewing table is used as an accessory box.

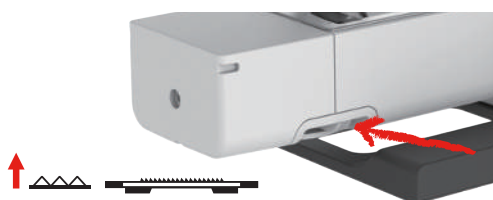
- > To remove the sewing table, hold the sewing table by the handle on the left and pull in the direction of the arrow.



- > To open the accessory box, tilt the cover towards you.
- > To close the accessory box, tilt the cover backwards until it clicks into place.



## 2.5 Raising or Lowering the Feed dog



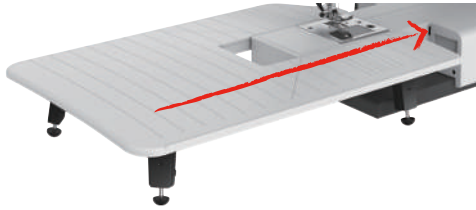
- > Slide the «Feed dog lever» right to raise the feed dog.
  - The feed dog is raised when the first stitch is sewn.
- > Slide the Feed dog lever left to lower the feed dog.
  - The feed dog is lowered.

## 2.6 Using the slide-on table

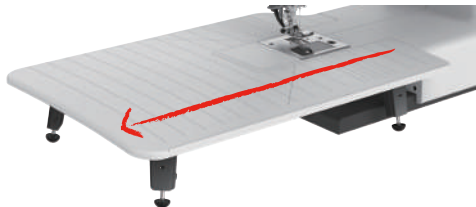
When attached to the free arm, it expands the already existing sewing area.

- > Raise the needle.
- > Raise the presser foot.
- > Switch the machine off and disconnect it from the power supply system.

- > Push the slide-on table to the right over the free arm until it engages.



- > To remove the slide-on table, pull the slide-on table over the free arm to the left.



## 2.7 Presser foot

### Adjusting the presser position via the knee lifter of the Free Hand System

- > Adjust the sitting height so that the knee lifter can be operated with the knee.
- > Push the knee lifter with the knee to the right to raise the presser foot.

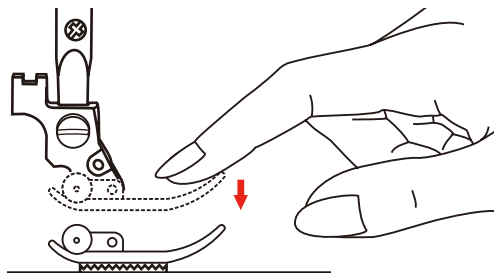


- Simultaneously the thread tension is released.
- > Release the knee lifter slowly to lower the presser foot.

### Changing the presser foot sole

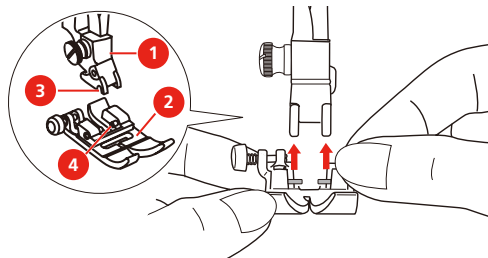
Removing the presser foot sole

- > Raise the presser foot.
- > Press down on the front of the presser foot sole by hand.



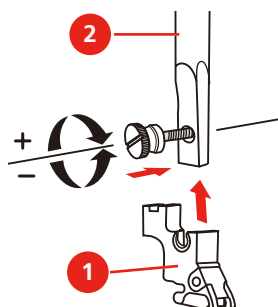
### Attaching the presser foot sole

- > Raise the presser foot (1).
- > Place the presser foot sole (2) under the shaft groove (3) so that the shaft groove is above the presser foot sole pin (4).
- > Then push the new presser foot sole upward until it engages.



### Removing and inserting the presser foot holder

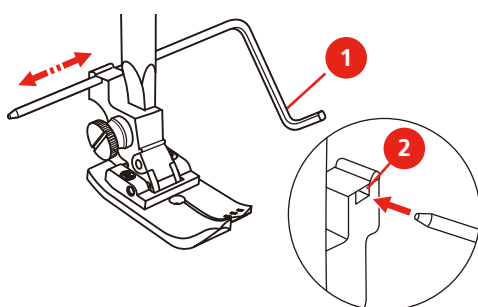
- > Raise the presser foot.
- > Align the presser foot holder (1) with the lower left side of the presser bar (2).
- > Hold the presser foot holder and drive the screw in manually.
- > Tighten the screw using the screwdriver.



### Inserting the edge/ quilting guide

The edge/ quilting guide supports sewing parallel lines.

- > Insert the edge/ quilting guide (1) in the slot (2).
- > Adjust the width as desired.



### Having the presser foot sole displayed in the user interface

The recommended presser foot sole for the selected stitch is displayed. Moreover, other optimal presser foot soles can be displayed.

- > Switch the machine on.
- > Select a stitch pattern.
  - In the icon «Presser foot sole display» the recommended presser foot sole is indicated with a letter.



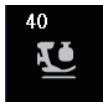
- > Touch the icon «Presser foot sole display».
  - Any presser foot soles are displayed.
  - A green tick indicates the recommended presser foot sole.
  - A yellow star indicates the presser foot soles which can also be used for this stitch for special purposes.



## Adjusting the presser foot pressure



The presser foot pressure is designed to adjust the pressure of the presser foot optimally to the fabric thickness. When working with thick fabrics, it is recommended to reduce the presser foot pressure. This provides the advantage that the presser foot is slightly lifted so that the fabric can be moved more easily. When working with thin fabrics, it is recommended to increase the presser foot pressure. This provides the advantage that the fabric cannot be moved too easily under the presser foot.

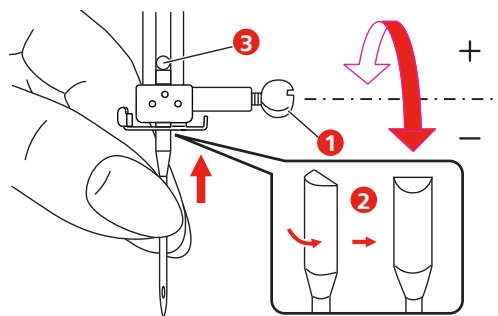


- > Touch the icon «Presser foot pressure».
- > Move the slide with the touchscreen pen/finger to adjust the presser foot pressure.

## 2.8 Needle and stitch plate

### Changing the needle

- > Raise the needle.
- > Switch the machine off and disconnect it from the power supply system.
- > Loosen the needle clamp screw (1) using the gray screwdriver.
- > Remove the presser foot.
- > Pull the needle down.
- > Hold the new needle (2) with the flat side to the back.
- > Insert the needle as far up as it will go (3).
- > Tighten the needle clamp screw using the screwdriver.



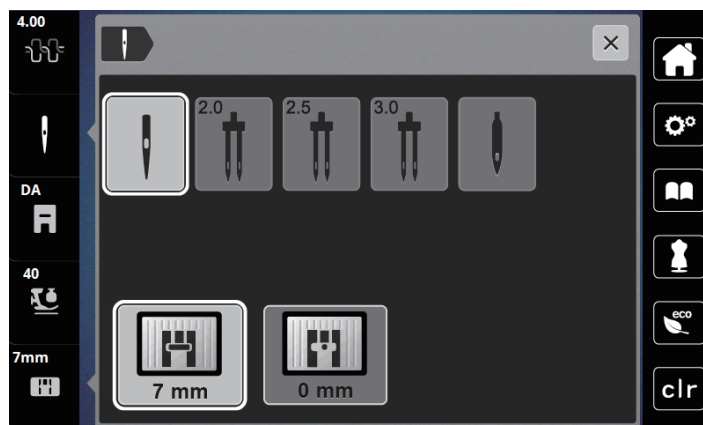


## Selecting the needle in the User Interface

After changing the stitch plate, you can check whether it can be used with the selected needle.



- > Touch the icon «Needle selection» or «Stitch plate selection».
- > Select the attached needle.



- When the selected needle matches the selected stitch plate and the presser foot, sewing can be started.
- If the selected needle does not match the stitch plate, a red exclamation mark appears.

## Needle stop up/down (permanent)



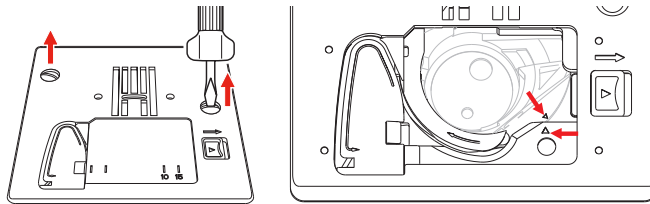
- > Touch the icon «Needle stop up/down (permanent)» to fix the needle position permanently.
  - The machine stops with needle position down as soon as the foot control is released or the button «Start/Stop» has been pressed.
- > Touch the icon «Needle stop up/down (permanent)» again.
  - The machine stops with needle position up as soon as the foot control is released or the button «Start/Stop» has been pressed.

## Changing the stitch plate

The stitch plates are marked with vertical, horizontal and diagonal lines in mm and inches. These lines help to guide the fabric when sewing seams and precise topstitching. **Please note:** The markings of the bobbin carrier of the stitch plate must be aligned in the same way.

Prerequisite:

- The feed dog is lowered.
  - The machine is switched off and disconnected from the power supply system.
  - The bobbin cover, the needle and the presser foot are removed.
- > Remove the screws of the stitch plate with the screwdriver.



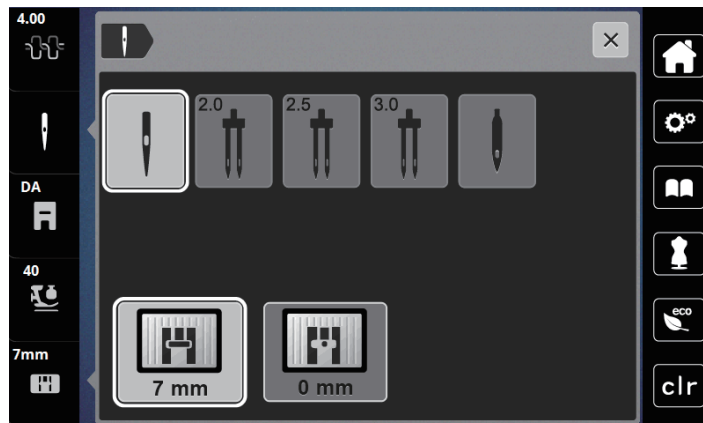
- > Remove the stitch plate.
- > Position the new stitch plate and tighten the screws with the screwdriver.

## Checking the stitch plate in the user interface

After having changed the stitch plate, it can be checked whether or not it is suitable to be used together with the selected needle.



- > Touch the icon «Needle selection» or «Stitch plate selection».
- The stitch plate is detected automatically and displayed.



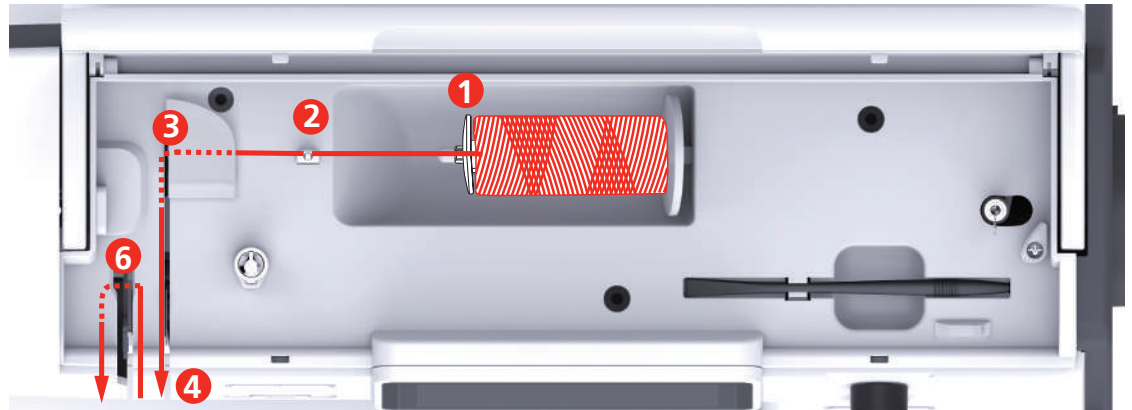
- If the selected stitch plate is suitable in combination with the needle, sewing can be started.
- Stitch width will be set to its allowed value automatically.
- If the selected needle does not match with the stitch plate, the machine will stop and sewing will not be allowed.

## 2.9 Threading

### Threading preparation

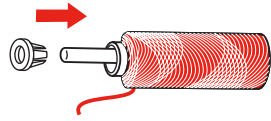
- > Press the button «Presser foot up/down» to raise the presser foot.
- > Raise the presser foot.

### Threading the upper thread

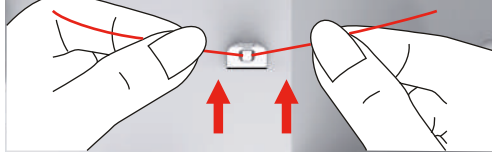


- |   |                            |    |                       |
|---|----------------------------|----|-----------------------|
| 1 | Spool disc                 | 7  | Guides                |
| 2 | Thread guide               | 8  | Guides                |
| 3 | Thread guide               | 9  | Needle threader lever |
| 4 | Silver discs               | 10 | Hook pin              |
| 5 | Thread take-up lever cover | 11 | Thread cutter         |
| 6 | Thread take-up lever       | 12 | Thread                |

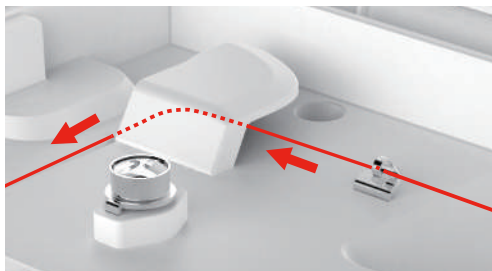
- > Place the thread spool on the spool holder so that the thread unwinds clockwise.
- > Add the appropriate spool disc.



- > Guide the thread from the spool through the upper thread guide (2).



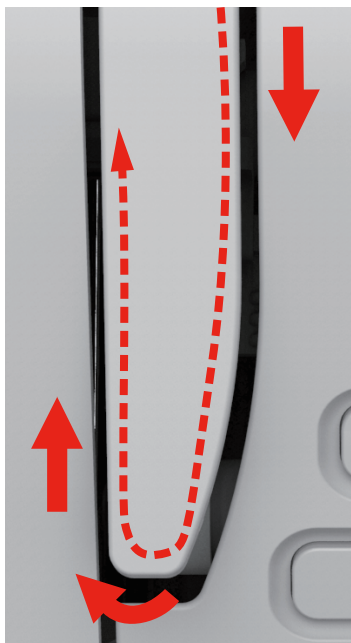
- > Guide the thread from the spool through the upper thread guide (3).



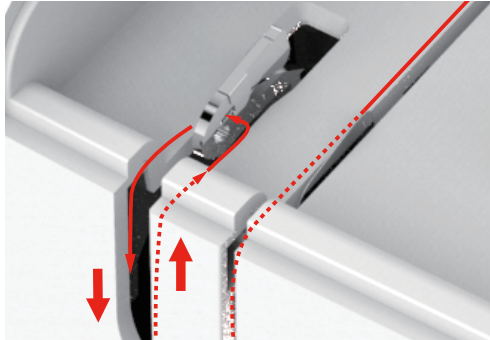
- > Place the thread end downwards along the duct.



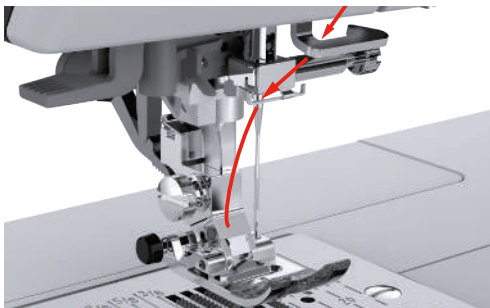
- > Then, down and around the check spring holder.



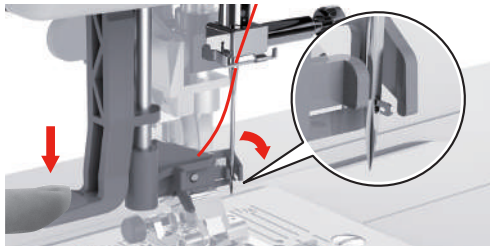
- > At the top of this movement pass the thread from right to left through the slotted eye of the take-up lever and then downwards again.



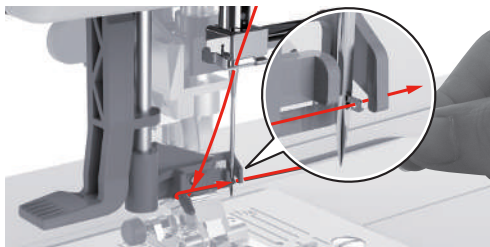
- > Guide the thread through the guides above the presser foot.



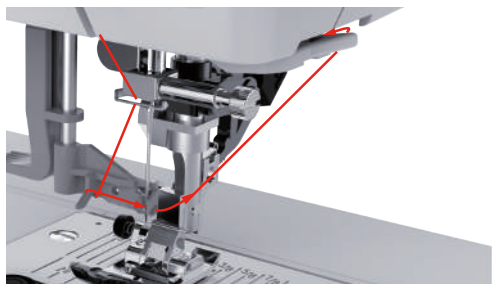
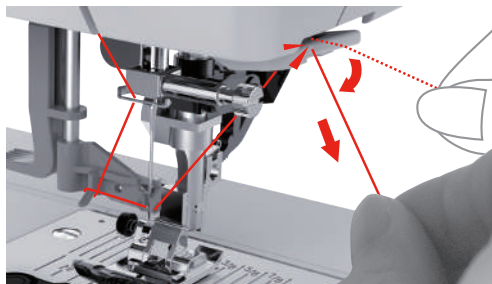
- > Press the lever to the very bottom until it clicks in.
  - The hook pin passes through the needle eye (9).
  - To prevent the threader from being damaged, the presser foot is lowered automatically.



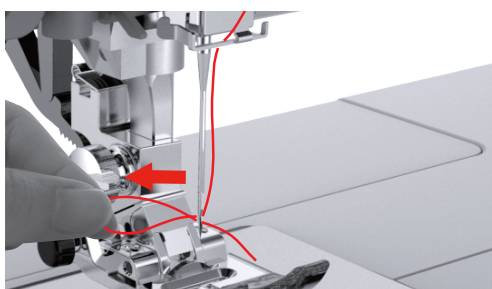
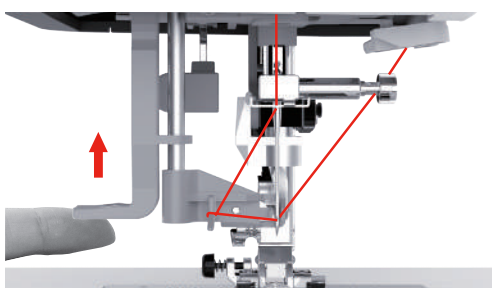
- > Guide the thread around thread guide.
- > Guide the thread in front of the needle and under the hook pin.



- > To cut the excess thread, take thread end and gently pull it over the thread cutter.



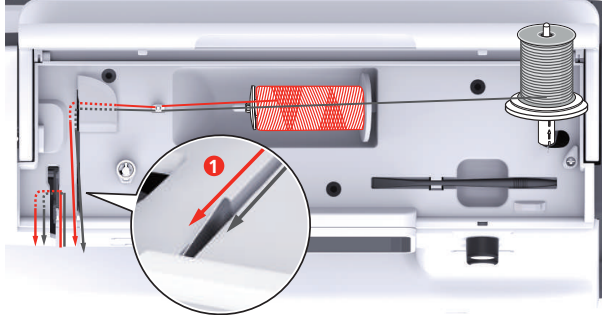
- > To thread the needle, lift the threader lever.
  - The hook retreats and passes the thread through the needle eye where a loop is formed.
- > Pull the thread through the needle eye.



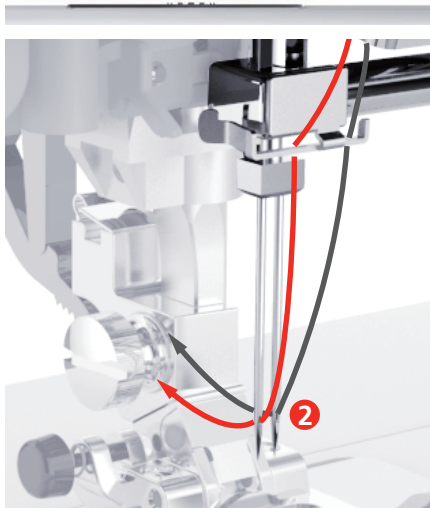
## Threading the double needle

Prerequisite:

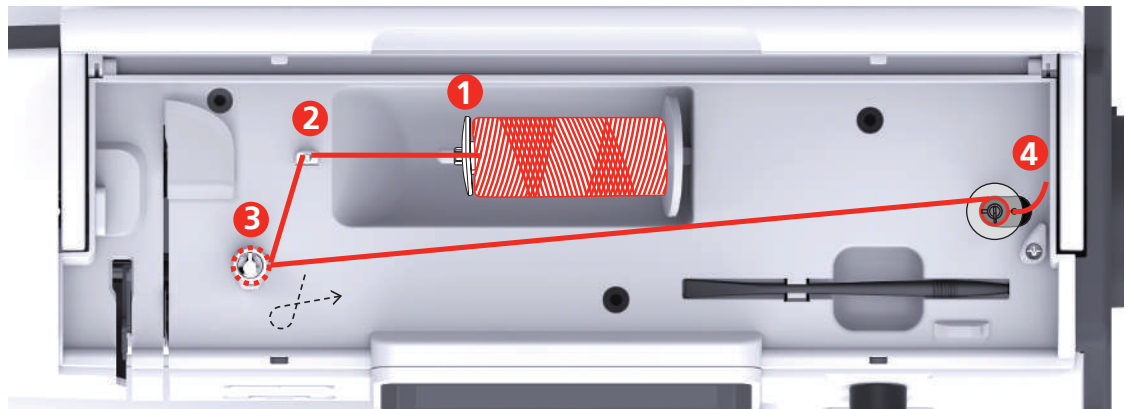
- The double needle is inserted.
  - The second spool pin, felt disc and thread spool are installed.
- > Guide the first thread in direction of the arrow on the right side of the tension disc (1).
- > Guide the second thread in direction of the arrow on the left side of the tension disc (1).



- > Guide the first and the second thread to the thread guide above the needle.
- > Thread the first thread manually into the right needle.
- > Thread the second thread manually into the left needle.

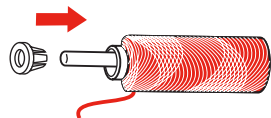


## Winding the bobbin thread

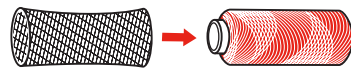


- |                |                     |
|----------------|---------------------|
| 1 Spool disc   | 3 Thread pretension |
| 2 Thread guide | 4 Spool pin         |

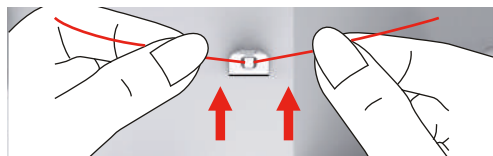
- > Place the thread spool and the appropriate spool disc on the spool holder.
- > For small thread spools use the spool disc.



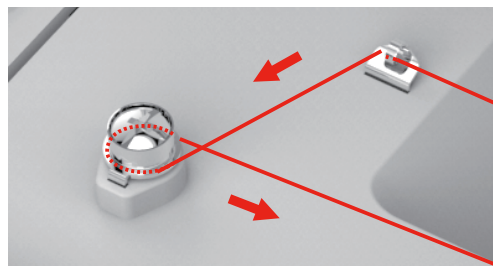
- > In order to prevent tangling of the thread, please use a spool net.



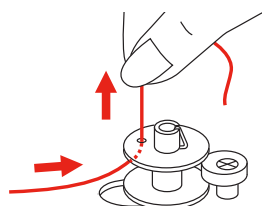
- > Guide the thread through the upper thread guide.



- > Guide the thread around the thread pretension clockwise.

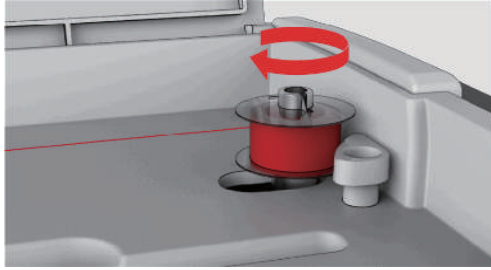


- > Place the thread end through one of the inner holes and place the empty bobbin on the winding unit.

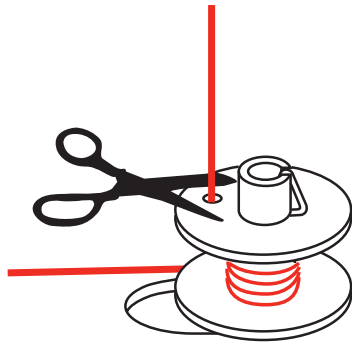




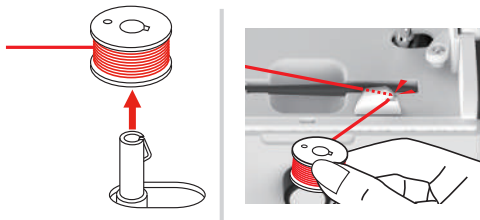
- > Push the bobbin to the right.
- > The button «Start/Stop» flashes and the display for winding appears.



- > Hold the thread end with one hand.
- > To start the winding process for a few rotations and then stop, push the button «»Start«/Stop», so that the thread is held tight on the bobbin.
- > Cut the thread end next to the inner hole.



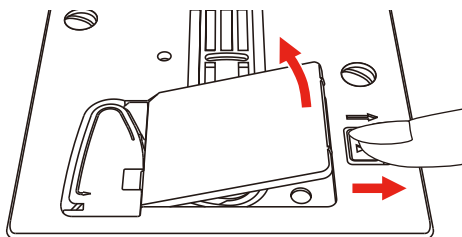
- > To continue the winding process, push the button «Start/Stop» or press the foot control.
- > To stop the winding process, push the button «Start/Stop» or press the foot control.
- > Remove the bobbin and cut the thread.



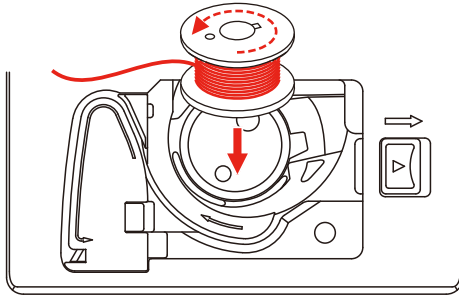
## Threading the bobbin thread

Prerequisite:

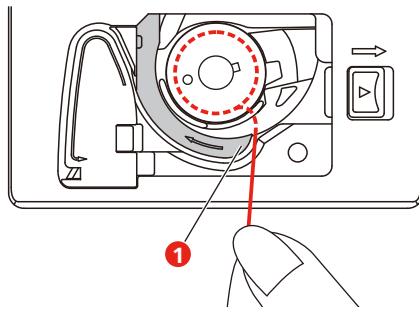
- The needle is raised.
  - The presser foot is raised.
  - The machine is switched off.
- > Open the bobbin cover by pushing the release button to the right.



- > Insert the new spool so that the thread is wound in the counterclockwise direction.



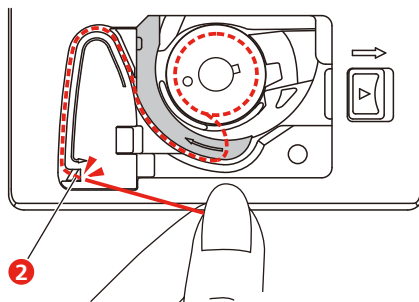
- > Pull the thread into the slit (1).



- > Press gently on the bobbin.
- > Follow the arrow markings to bring the thread into the bobbin thread guide.



- > To cut excess thread, take the thread end and pull over the thread cutter (2).



- > Close the bobbin cover.

## 3 Setup Program

### 3.1 Sewing settings

#### Adjusting the upper thread tension

Adjustments to the upper thread tension in the Setup Program affect all stitch patterns. Individual alteration of the upper thread tension can also be made for currently selected stitches.



> Touch the icon «Setup Program».



> Touch the icon «Sewing settings».



> Touch the icon «Alter the upper thread tension».  
> Move the slide using the touchscreen pen/finger or touch the icons «+» or «-» to alter the upper thread tension.

#### Adjusting the maximum sewing speed

By using this function, the maximum speed can be reduced.



> Touch the icon «Setup Program».



> Touch the icon «Sewing settings».



> Touch the icon «Alter the maximum speed».  
> Move the slide using the touchscreen pen/finger or touch the icons «+» or «-» to alter the maximum speed.

#### Programming the securing stitches

If the function is activated, 4 securing stitches are sewn automatically at the pattern start after the thread cut.



> Touch the icon «Setup Program».



> Touch the icon «Sewing settings».



> Touch the switch using the touchscreen pen/finger to deactivate the securing stitches.  
> Touch the switch again to activate the securing stitches.

## Adjusting the hovering height of the presser foot

The hovering height of the presser foot can be adjusted according to the fabric thickness from 1 to maximal 6 mm.



> Touch the icon «Setup Program».



> Touch the icon «Sewing settings».



> Touch the icon «Program buttons and icons». Touch the switch again to deactivate the presser foot raised to hovering position with needle stop down.



> Touch the icon «Program the hovering position of the presser foot».  
> Turn the «Upper Multifunction knob» or the «Lower Multifunction knob» or touch the icons «-» or «+» to adjust the distance between the stitch plate and the presser foot.

## Programming the button «Securing»

Number and type of securing stitches can be programmed.

The number of securing stitches for practical stitches can be programmed in the upper section of the display (1).

Securing of decorative stitches or stitch pattern combinations can be programmed in the lower section of the display (2).



> Touch the icon «Setup Program».





> Touch the icon «Sewing settings».



> Touch the icon «Program buttons and icons».








> Touch the icon «Program securing».  
> Touch the icons «-» or «+» in the upper section of the display (1) to program the number of securing stitches in close succession for practical stitches.

- 
  - > Touch the icon «Securing» to activate automatic securing for decorative stitches and combined stitches.
  - > Touch the icons «-» or «+» in the lower section of the display (2) to program the number of securing stitches in close succession.
  - > Touch the icon «Securing» again to deactivate automatic securing for decorative stitches and combined stitches.
- 
  - > To secure the selected pattern at the end, touch the icon «Pattern end».
    - The machine secures and stops at the end of the pattern.
  - > To deactivate securing at the end of the pattern, touch the icon «Pattern end» again.






### Programming the button «Thread cutter»

The automatic securing can be programmed before the thread cut takes place.

- 
  - > Touch the icon «Setup Program».
- 
  - > Touch the icon «Sewing settings».
- 
  - > Touch the icon «Program buttons and icons».
- 
  - > Touch the icon «Program the button thread cutter».
- 
  - > Touch the icon «Securing» to activate 4 securing stitches before cutting.
  - > Touch the icons «-» or «+» to program the number of securing stitches.
  - > Touch the icon «Securing» again to deactivate the automatic securing.

### Adjusting the presser foot position with needle stop down

With lowered needle, the presser foot is raised to hovering position when the needle is programmed in the down position.

- 
  - > Touch the icon «Setup Program».
- 
  - > Touch the icon «Sewing settings».
- 
  - > Touch the icon «Program buttons and icons». Touch the switch again to deactivate the presser foot raised to hovering position with needle stop down.
- 
  - > Touch the icon «Adjust the presser foot position with needle stop down».
- 
  - > Touch the switch to activate the presser foot raised to hovering position with needle stop down.
  - > Touch the switch again to deactivate the presser foot raised to hovering position with needle stop down.

### Programming the button «Quick reverse»

It can be chosen either «Reverse sewing» or «Backstepping».



> Touch the icon «Setup Program».



> Touch the icon «Sewing settings».



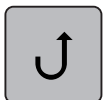
> Touch the icon «Program buttons and icons». Touch the switch again to deactivate the presser foot raised to hovering position with needle stop down.



> Touch the icon «Program Quick reverse».



> Touch the icon «Backstepping» to activate backstepping.



> Touch the icon «Backstepping» to activate backstepping.

### Programming the foot control individually

When the icon «Needle up/down» is activated, the needle is raised or lowered via a back kick on the foot control. Alternatively, the presser foot can be positioned, the thread can be cut and the automatic securing can be programmed.



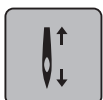
> Touch the icon «Setup Program».



> Touch the icon «Sewing settings».



> Touch the icon «Program the foot control».



- The icon «Needle up/down» is activated by default.
- The back kick on the foot control raises or lowers the needle.



> Touch the icon «Program the back kick» to program the back kick.



- > Touch the icon «Securing» to activate the automatic securing via the back kick.
- > Touch the icons «-» or «+» to program the number of securing stitches.
- > Touch the icon «Securing» again to deactivate the automatic securing via the back kick.



- > Touch the icon «Cut thread» to activate the automatic thread cut via the back kick.
- > Touch the icon «Cut thread» again to deactivate the thread cut via a back kick on the foot control.



- > Touch the icon «Position the presser foot» so that the presser foot remains down via the back kick.
- > Touch the icon «Position the presser foot» again so that the presser foot remains up via the back kick.
  - If only «Position the presser foot »is activated without «Cut thread» and «Securing», the function can move presser foot to hovering position or highest position (12 mm).

### Fabric thickness measurement

While sewing, the machine continuously checks the current fabric thickness and adjusts a proper presser foot pressure in time to keep a smooth feed of the fabric.



- > Touch the icon «Setup Program».



- > Touch the icon «Sewing settings».



- > To activate the automatic compensation of the presser foot pressure, touch the icon «Fabric thickness measurement».
- > To deactivate the automatic compensation of the presser foot pressure, touch the icon «Fabric thickness measurement» again.

### Adjusting the general balance

Different fabrics, threads and stabilizers can affect the programmed stitch patterns so that they cannot be sewn out correctly. The electronic balance can correct these deviation and the stitch pattern can be adjusted optimally to the selected fabric.

- > Select a stitch pattern or alphabet.
- > Touch the icon "Setup Program".



- > Touch the icon "Sewing settings".



- > Touch the icon "Balance".
  - A preview of the stitch pattern is displayed.
- > To correct the longitudinal direction of the stitch pattern, turn the «Multifunction knob» until the preview of the stitch pattern matches the stitch pattern sewn on the fabric.

## 3.2 Embroidery settings

### Adjusting the upper thread tension

Alterations of the upper thread tension in the Setup Program affect all embroidery motifs.



- > Touch the icon «Setup Program».



- > Touch the icon «Embroidery settings».



- > Touch the icon «Alter the upper thread tension».
- > Move the slide using the touchscreen pen/finger or touch the icons «+» or «-» to alter the upper thread tension.

## Adjusting the maximum embroidering speed

By using this function, the maximum speed can be reduced.



> Touch the icon «Setup Program».



> Touch the icon «Embroidery settings».



> Touch the icon «Alter the maximum speed».  
 > Move the slide using the touchscreen pen/finger or touch the icons «+» or «-» to alter the maximum speed.

## Calibrating the embroidery hoop

The calibration of the embroidery hoop is the coordination of the needle to the center of the embroidery hoop.

Prerequisite:

- The embroidery module is connected and the embroidery hoop with the appropriate embroidery template is attached.



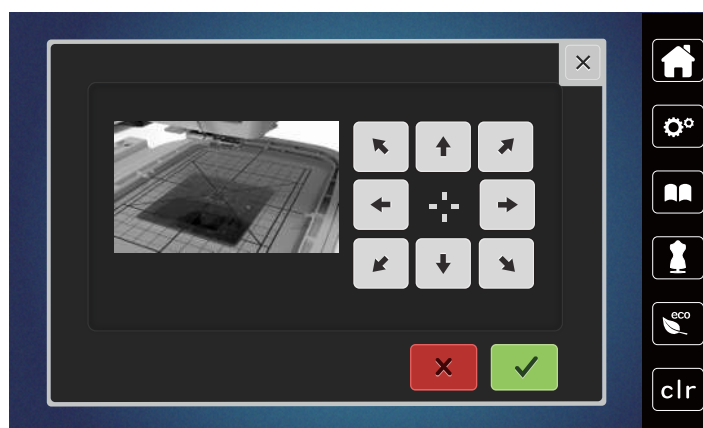
> Touch the icon «Setup Program».



> Touch the icon «Embroidery settings».



> Touch the icon «Calibrate the embroidery hoop».  
 – The machine recognizes the size of the attached embroidery hoop automatically and moves to the center of the hoop.  
 > Center the needle via the arrow icons on the display and confirm.



## Deactivating securing stitches



> «»Touch the icon «Setup Program».





- > Touch the icon «Embroidery settings».



- > Touch the icon «Securing stitches on/off».
- > Touch the switch in the lower left corner of the display to deactivate the securing stitches.
  - No securing stitches will be sewn and the bobbin thread needs to be brought up manually and held when embroidering is started.
- > Touch the switch again to activate the securing stitches.

### Adjusting the thread cut



- > Touch the icon «Setup Program».



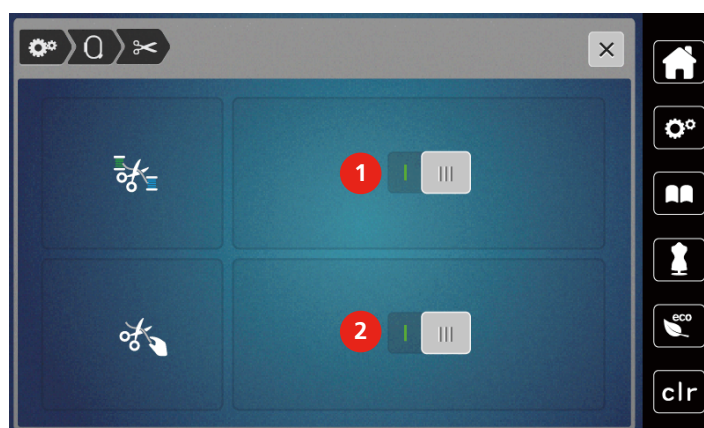
- > Touch the icon «Embroidery settings».



- > Touch the icon «Thread cut settings».



- > To deactivate the automatic thread cut before changing a thread, press the switch in the upper section of the display (1).
- > To activate the automatic thread cut before changing a thread, press the switch in the upper section of the display (1) again.
- > Touch the switch in the lower section of the display (2) to deactivate the automatic thread cut after starting embroidering.
  - The machine won't stop for a manual thread cut.
- > To activate the manual thread cut after embroidering, press the switch in the lower section of the display (2).
  - The machine will stop after about 7 stitches.
- > Cut the remaining thread with scissors.



### Adjusting the height of the embroidery presser foot



- > Touch the icon «Setup Program».



> Touch the icon «Embroidery settings».



> Touch the icon «Adjust the height of the embroidery presser foot».  
 > Turn the «Upper Multifunction knob» or the «Lower Multifunction knob» or touch the icons «-» or «+» to adjust the distance between the stitch plate and the presser foot.

### 3.3 Selecting personal settings



> Touch the icon «Setup Program».



> Touch the icon «Personal settings».  
 > Select the desired display color.



### 3.4 Monitoring functions

#### Activating the upper thread indicator



> Touch the icon «Setup Program».



> Touch the icon «Monitoring settings».



> Touch the switch in the upper portion of the display to deactivate the upper thread indicator.  
 > Touch the switch again to activate the upper thread indicator.

#### Activating the bobbin thread indicator



> Touch the icon «Setup Program».



> Touch the icon «Monitoring settings».



> Touch the switch in the lower section of the display to deactivate the bobbin thread indicator.  
 > Touch the switch again to activate the bobbin thread indicator.

### 3.5 Sound on/off



- > Touch the icon «Setup Program».



- > Touch the icon «Sound on/off» to deactivate any audio signals in general.
- > Touch the icon «Sound on/off» again to deactivate any audio signals in general.

### 3.6 Machine settings

#### Adjusting the brightness of the display

The brightness of the display can be adjusted corresponding to the personal preferences.



- > Touch the icon «Setup Program».



- > Touch the icon «Machine settings».



- > Touch the icon «Adjust the brightness».
- > Move the slide in the upper portion of the display using the touchscreen pen/finger or touch the icons «+» or «-» to alter the brightness of the display.

#### Adjusting the sewing light

The brightness of the sewing light can be adjusted corresponding to the personal preferences.



- > Touch the icon «Setup Program».



- > Touch the icon «Machine settings».



- > Touch the icon «Adjust the brightness».
- > Move the slide in the upper portion of the display using the touchscreen pen/finger or touch the icons «+» or «-» to alter the brightness of the sewing light.



- > Touch the switch to switch the sewing light off.
- > Touch the switch again to switch the sewing light on.

#### Calibrating the display

Please find further information on this topic in the chapter attachment below troubleshooting at the end of the instruction manual.



- > Touch the icon «Setup Program».

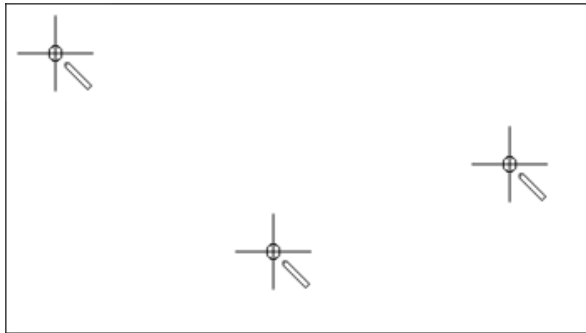


- > Touch the icon «Machine settings».



- > Touch the icon «Calibrate the display».

- > Touch the crosses in sequence using the touchscreen pen.



### Back to default setting

**ATTENTION:** Using this function will delete all individually made settings.



- > Touch the icon «Setup Program».



- > Touch the icon «Machine settings».



- > Touch the icon «Default settings».



- > Touch the icon «Default setting sewing».



- > Touch the icon «Confirm» to restore the default settings for the sewing settings.



- > Touch the icon «Default setting embroidery».



- > Touch the icon «Confirm» to restore the default settings for the embroidery settings.



- > Touch the icon «Default setting all».



- > Touch the icon «Confirm» and restart the machine to restore all default settings.

### Updating the machine Firmware

The latest firmware of the machine and a detailed step-by-step instruction for updating processes can be downloaded at [www.mybernette.com](http://www.mybernette.com). Personal data and settings are automatically transferred during a firmware update.

#### NOTICE

USB stick (optional accessory) has been removed too early

Firmware has not been updated and the machine cannot be used.

- > Remove the USB stick (Optional accessory) only after the saved data has been transferred successfully.

- > Insert the BERNINA USB Stick (optional accessory), FAT32 formatted, providing the latest software into the port.



- > Touch the icon «Setup Program».



> Touch the icon «Machine settings».



> Touch the icon «Firmware version».



> Touch the icon «Update» to start the update of the firmware.

### Checking the firmware version

The firmware version of the machine is displayed.



> Touch the icon «Setup Program».



> Touch the icon «Machine settings».



> Touch the icon «Firmware version».

### Reviewing the total number of stitches

The total number of stitches of the machine as well as the number of stitches since the last service carried out by the specialized dealer are displayed.



> Touch the icon «Setup Program».



> Touch the icon «Machine settings».



> Touch the icon «Firmware version».

### Selecting a language

The User Interface can be programmed in different languages according to the customer's wish.



> Touch the icon «Setup Program».



> Touch the icon «Machine settings».



> Touch the icon «Language selection».  
> Select a language.

## 4 System settings

### 4.1 Calling up the Tutorial

The tutorial provides information and explanations on different sections concerning sewing and embroidering and the various stitches.



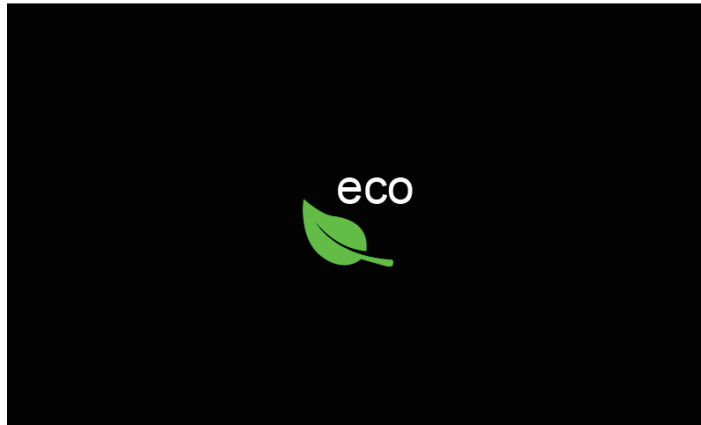
- > Touch the icon «Tutorial».
- > Select the desired topic to get information.

### 4.2 Using eco mode

During a longer interruption of work the machine can be set into a power save mode. Nothing can be selected in the display and the machine cannot be started.



- > Touch the icon «eco» again.
  - The display goes to sleep. The power consumption is reduced and the sewing light is off.



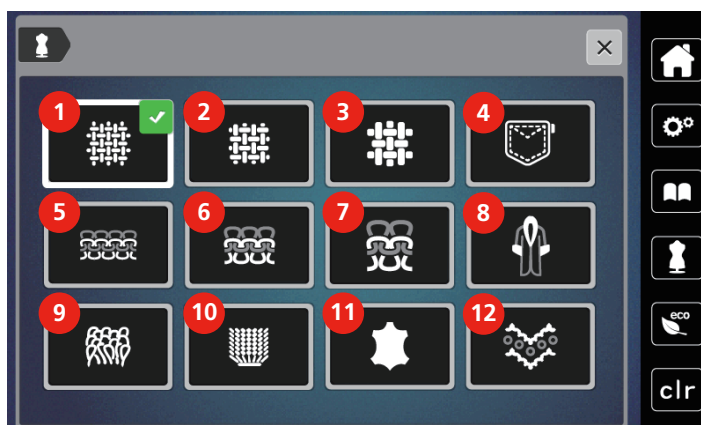
- > Quickly click the green icon «eco» on the screen.
  - The machine is ready for use.

### 4.3 Calling up the Creative Consultant

The Creative Consultant provides information about decision support concerning sewing projects. After entering the fabric and the desired sewing project, suggestions for suitable needles, presser feet etc. are displayed.

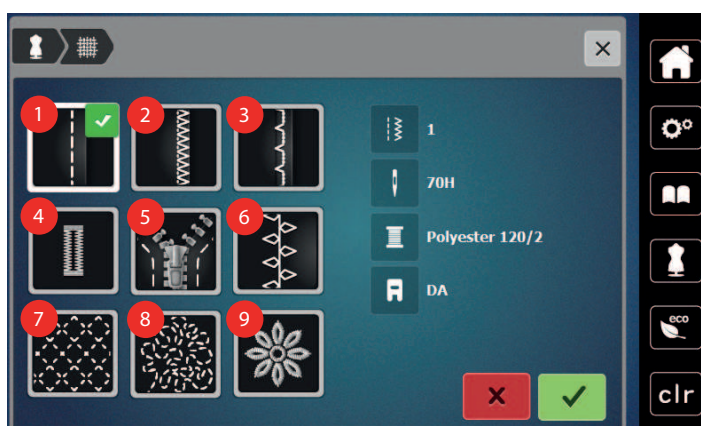


- > Touch the icon «Creative Consultant».
- > Select the fabric to be sewn.

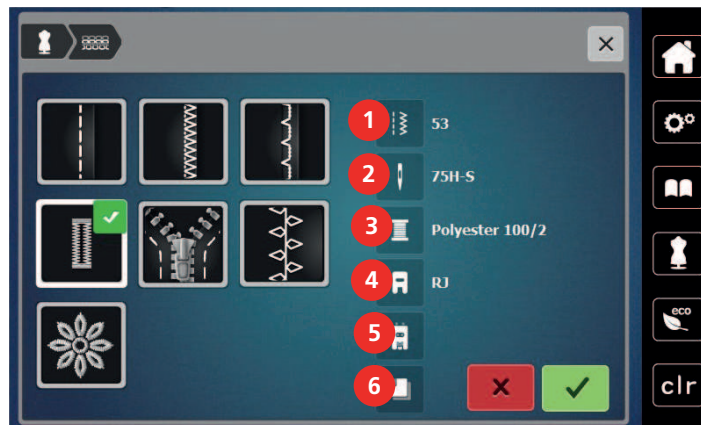


- |   |                     |    |                             |
|---|---------------------|----|-----------------------------|
| 1 | Light-weight woven  | 7  | Heavy knits                 |
| 2 | Medium-weight woven | 8  | Fake fur/coated fake fur    |
| 3 | Heavy-weight woven  | 9  | Toweling                    |
| 4 | Jeans               | 10 | Fabric with a piled texture |
| 5 | Light knits         | 11 | Leather and vinyl           |
| 6 | Medium-weight knits | 12 | Net and Lace                |

- > Select the sewing project.
  - The stitch is changed automatically, but all other settings must be done by the user.



- |   |                 |   |                    |
|---|-----------------|---|--------------------|
| 1 | Seams           | 6 | Creative sewing    |
| 2 | Finishing edges | 7 | Machine quilting   |
| 3 | Blindstitch hem | 8 | Free motion sewing |
| 4 | Buttonholes     | 9 | Appliqués          |
| 5 | Zippers         |   |                    |



- |   |                           |   |                          |
|---|---------------------------|---|--------------------------|
| 1 | Recommended stitch number | 4 | Recommended presser foot |
| 2 | Recommended needle        | 5 | Reinforced buttonhole    |
| 3 | Recommended thread        | 6 | Stabilizer recommended   |
- > Make the settings of the machine according to the instructions.

#### 4.4 Cancelling any alterations with «clr»

Any alterations to motifs can be reset to default setting. Exceptions are saved motifs which have been filed in the personal memory and monitoring functions.

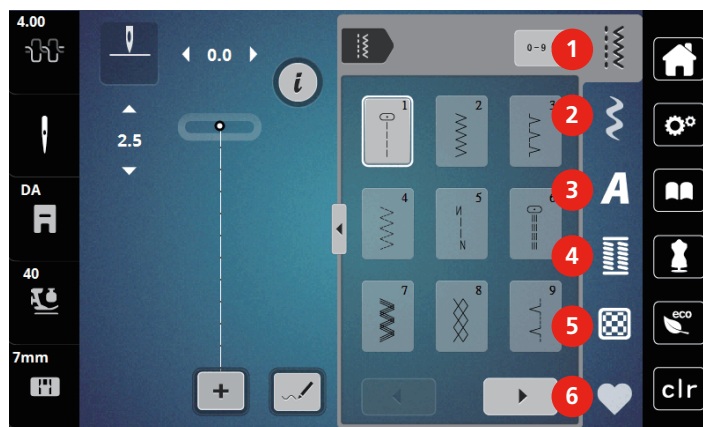


- > Touch the icon «clr».



## 5 Creative sewing

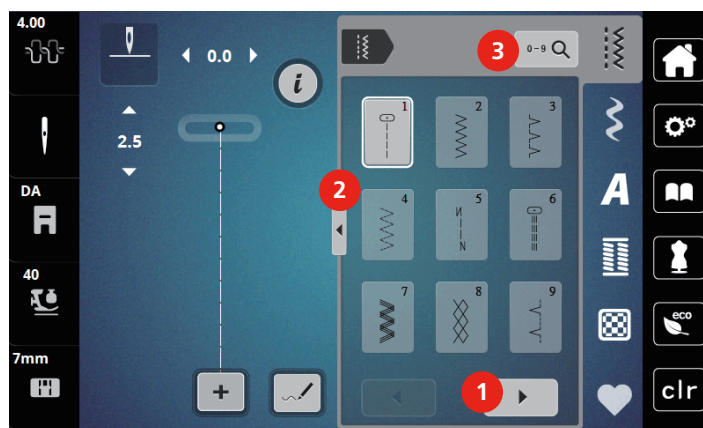
### 5.1 Overview selection menu sewing



- |   |                     |   |                 |
|---|---------------------|---|-----------------|
| 1 | Practical stitches  | 4 | Buttonholes     |
| 2 | Decorative stitches | 5 | Quilt stitches  |
| 3 | Alphabets           | 6 | Personal Memory |

#### Selecting a stitch pattern

- > Select a stitch pattern, an alphabet or a buttonhole.
- > Touch the icon «Scrolling» (1) to have more stitch patterns displayed.
- > Touch the icon «Display all the stitch patterns» (2) to scale up the view.
- > Touch the icon «Display all the stitch patterns» (2) again to downsize the stitch pattern view.
- > Touch the icon «Stitch pattern number entry» (3) to select the stitch pattern via entering the stitch number.
  - If «!!!» appear when entering the stitch pattern, the stitch pattern cannot be used in the Combi mode.
  - If «???» appear when entering the stitch pattern, the stitch pattern doesn't exist.



## 5.2 Dual Feed (DF)



It is recommended to match the presser foot pressure with the fabric. The thicker the fabric, the lower the presser foot pressure.

The Dual Feed feeds the fabric from above and from beneath simultaneously. This provides an even and careful feed forward even for smooth and thin materials. Striped and checkered patterns can be matched perfectly by even feeding.

### Application of the Dual Feed

In general, the Dual Feed is used for the following sewing projects:

- Sewing: All sewing applications with difficult fabrics such as for seams, zippers.
- Patchwork: With accurate stripes, blocks and with decorative stitches up to a stitch width of 7 mm.
- Appliqués: Sewing on ribbons and bias binding

Difficult-to-work-with fabrics are:

- Velvet, normally sewn with the grain
- Toweling
- Jersey, especially when sewing it crosswise to knit
- Fake fur or coated fake fur
- Fleece-types of fabrics
- Batted fabrics
- Stripes and checks
- Curtain fabrics with pattern repeats

«Sticky» fabrics are:

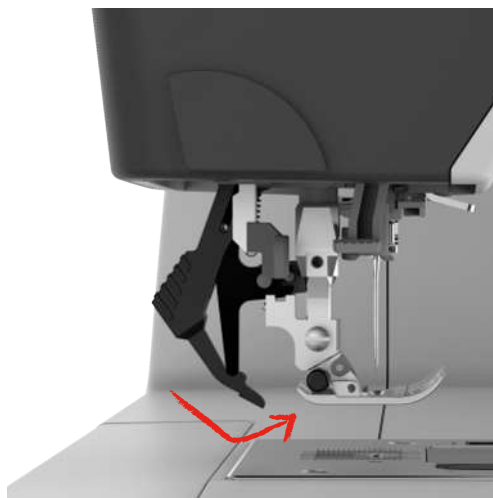
- Imitation leather, coated fabrics

### Use the Dual Feed



Only use presser feet with the back opening when engaging the DF mechanism.

- > Raise the presser foot.
- > Swing the DF mechanism forward under the back of the presser foot until it clicks in position.



- > Raise the presser foot.
- > Pull down the DF mechanism and swing it to the rear to disengage.

### 5.3 Regulating the speed

The sewing speed can be adjusted infinitely variable with the slide.

- > Move the slide to the left to reduce the sewing speed.
- > Move the slide to the right to increase the sewing speed.

### 5.4 Adjusting the upper thread tension

Basic settings are applied automatically when a stitch pattern or program is selected.

When using different types of sewing threads, the optimal tension may vary. Therefore it may be necessary to adjust the upper thread tension according to the sewing project as well as the desired stitch pattern individually.

Alteration of the upper thread tension affect the currently selected stitch pattern or embroidery motif. Permanent alterations of the upper thread tension for the sewing can be made in the Setup Program.



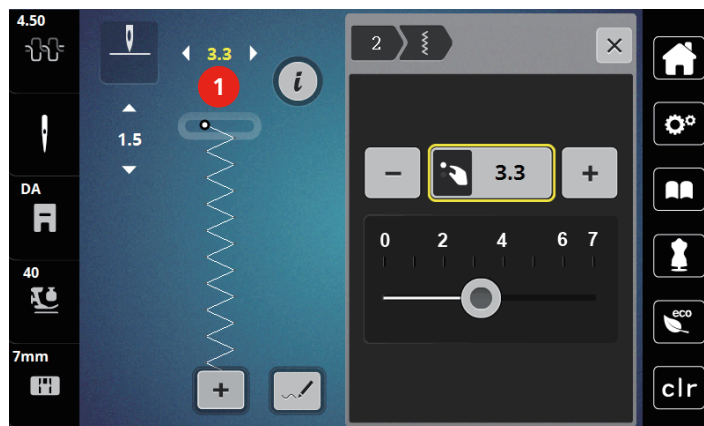
- > Touch the icon «Upper thread tension».
- > Move the slider in the display using the touchscreen pen/finger to increase or reduce the upper thread tension.



### 5.5 Editing stitch patterns

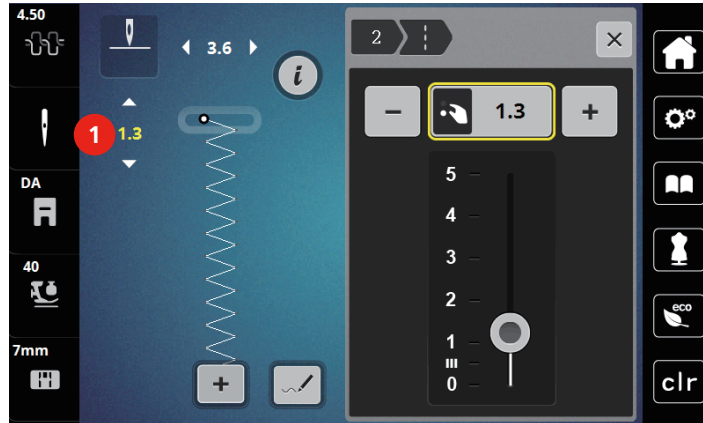
#### Changing the stitch width

- > Turn the «Upper Multifunction knob» to the left to narrow the stitch width.
- > Turn the «Upper Multifunction knob» to the right to widen the stitch width.
- > To call up further setting options, touch the icon «Stitch width» (1).



## Changing the stitch length

- > Turn the «Lower Multifunction knob» to the left to shorten the stitch length.
- > Turn the «Lower Multifunction knob» to the right to elongate the stitch length.
- > To call up further setting options, touch the icon «Stitch length» (1).



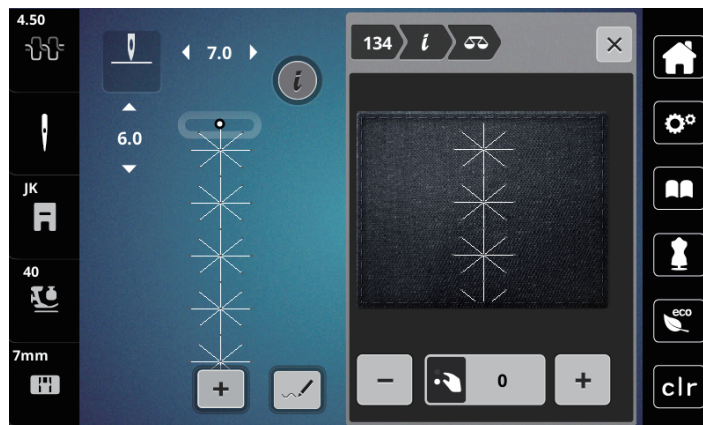
## Correcting the balance

Different fabrics, threads and stabilizers can affect the programmed stitch patterns so that they cannot be sewn out correctly. The electronic balance can correct these deviation and the stitch pattern can be adjusted optimally to the selected fabric.

- > Select a stitch pattern or alphabet.
- > Sewing stitch pattern.
- > Touch the icon «i»-Dialog.



- > Touch the icon «Confirm».
  - A preview of the stitch pattern is displayed.



- > To correct the longitudinal direction of the stitch pattern, turn the «Lower Multifunction knob» until the preview of the stitch pattern matches the stitch pattern sewn on the fabric.
- > Altered balance settings can be saved for each stitch in the «Personal memory».
- > Altered balance settings only remain valid until the «clr button» is pressed or the machine is switched off.

### Programming pattern repeat

- > Select a stitch pattern or alphabet.
- > Touch the icon «i»-Dialog.



- > Touch the icon «Pattern repeat» once to repeat the stitch pattern.
- > Touch the icon «Pattern repeat» twice up to 9 times to repeat the stitch pattern up to 9 times.
  - The machine stops automatically after the programmed number of patterns has been sewn.



- > To secure a step stitch at the sewing end, the icon «Securing» is activated.
- > Touch the icon «Securing» to deactivate the securing.

### Mirror image of stitch patterns

- > Select a stitch pattern or alphabet.
- > Touch the icon «i»-Dialog.



- > Touch the icon «Mirror image left/right» to mirror the stitch pattern from left to right.



- > Touch the icon «Mirror image up/down» to mirror the stitch pattern contrary to the sewing direction.

### Editing stitch pattern length

Stitches from category satin stitch pattern can be lengthwise extended or shortened.

- > Select a stitch pattern.
- > Touch the icon «i»-Dialog.



- > Touch the icon «Editing stitch pattern length».
- > Move the slide with or touch the «+»/«-» icons (1) to determine the length of the stitch pattern.
- > Touch the icons «+»/ «-» (2) to determine the density of the stitch pattern.



### Permanent Quick reverse

- > Select a stitch pattern or alphabet.
- > Touch the icon «i»-Dialog.



- > Touch the icon «Permanent reverse sewing» (1) to sew permanently in reverse.

### Backstepping

- > Select a stitch pattern, alphabet or buttonhole.
- > Touch the icon «i»-Dialog.

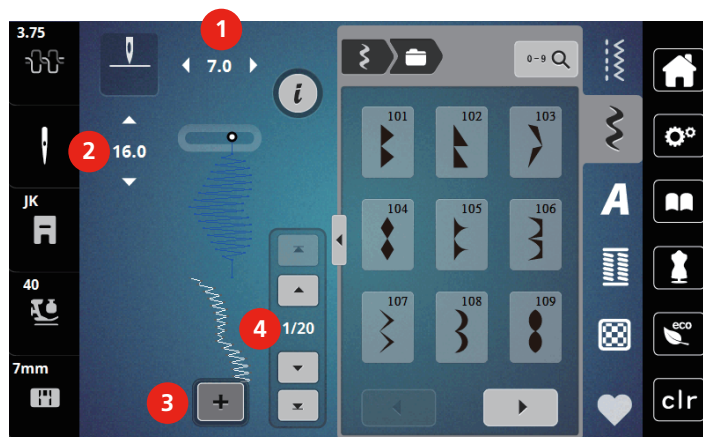


- > Touch the icon «Backstepping» (2) to backstep the stitches.



## 5.6 Combining stitch patterns

### Overview Combi mode



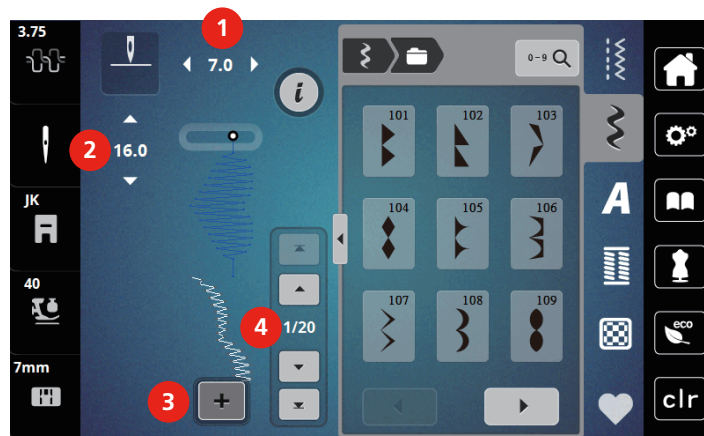
- |   |   |   |   |
|---|---|---|---|
| 1 | Stitch width of the active stitch pattern.  | 3 | Combi mode/Single mode                        |
| 2 | Stitch length of the active stitch pattern. | 4 | Single stitch pattern within the combination. |

## Creating Stitch pattern combinations

In the Combi mode stitch patterns and alphabets can be combined according to your wish. Each combination can hold up to 20 stitches. Patterns created in the Stitch Designer cannot be integrated in the pattern combinations.



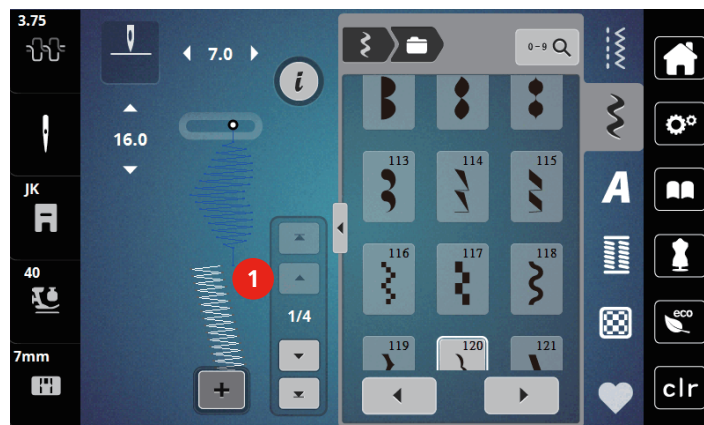
- > Touch the icon «Single/Combi mode» (3).
- > Select the desired stitch patterns.



- > Touch the icon «Single/Combi mode» again to return to the single mode.

## Editing a single stitch pattern

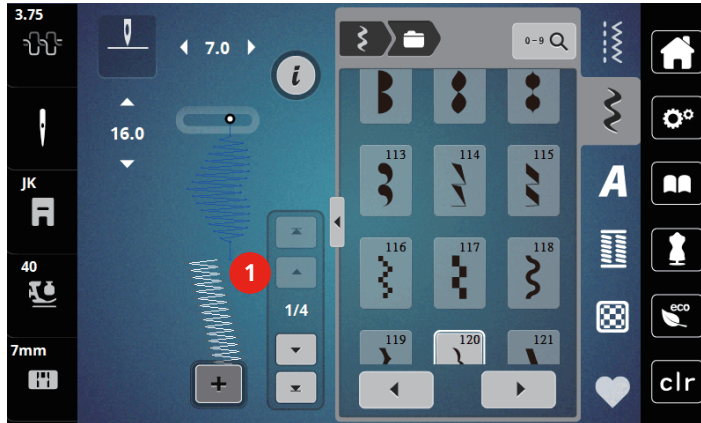
- > Create a stitch pattern combination.
- > With the touchscreen pen/finger touch the desired position (1) within the stitch pattern combination to select a single stitch pattern.



- > Touch the icon «i»-Dialog to edit the single stitch pattern.

### Deleting a single stitch pattern

- > Create a stitch pattern combination.
- > With the touchscreen pen/finger touch the desired position (1) within the stitch pattern combination to select a single stitch pattern.



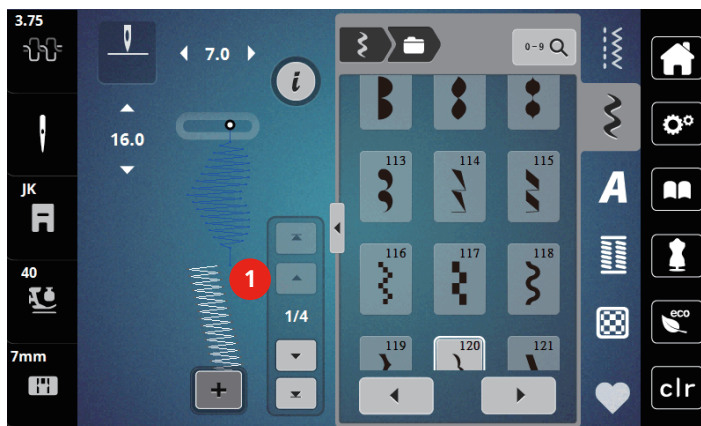
- > Touch the icon «i»-Dialog.



- > Touch the icon «Delete» to delete the individual stitch pattern.

### Adding a single stitch pattern

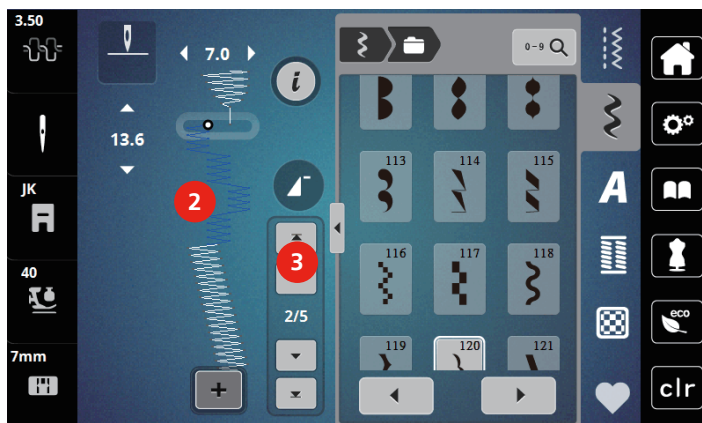
- > In order to add a stitch pattern at the beginning, move to the very front of the stitch pattern group and press the second upper arrow (1).
  - Both upper arrows are inactive.
- > Add a new stitch pattern.



- > Create a stitch pattern combination.

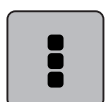


- > Touch the desired position (2) within the stitch pattern combination or touch the scroll arrow (3) to select a single stitch pattern.



### Mirroring a stitch pattern combination

- > Create a stitch pattern combination.
- > Touch the icon «i»-Dialog.



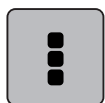
- > Touch the icon «Edit the complete combination».



- > Touch the icon «Mirror image left/right» to mirror the whole stitch pattern combination from the left to the right.
- > Touch the icon «Mirror image left/right» again to reset the alterations to default setting.

### Programming pattern repeat

- > Create a stitch pattern combination.
- > Touch the icon «i»-Dialog.



- > Touch the icon «Edit the complete combination».



- > Touch the icon «Pattern repeat» once to repeat the stitch pattern combination.
  - «Securing» at the final end of the combination is activated.
- > Touch the icon «Pattern repeat» again to repeat the stitch pattern combination up to 9 times.
- > Touch the icon «Pattern repeat» and hold until an «X» appears instead of a number.

### Securing a stitch pattern combination

Securing stitches at the end of the stitch pattern combination is activated.

- > Touch the icon «Securing at the whole combination end» to deactivate securing at the end of the stitch pattern combination.
- > Create a stitch pattern combination.
- > Touch the icon «i»-Dialog.



- > Touch the icon «Edit the complete combination».



### Saving a stitch pattern combination

To be able to use individually created stitch pattern combinations, they can be saved in «Personal Memory».

- > Create a stitch pattern combination.
- > Touch the icon «Personal memory».



- > Touch the icon «Save stitch pattern».



- > Touch the icon «Confirm» or the yellow-framed icon to save the stitch pattern combination.

### Loading a stitch pattern combination

- > Touch the icon «Single/Combi mode».



- > Touch the icon «Personal memory».



- > > Touch the icon «Selection of stitch pattern combination».
- > Select a stitch pattern combination.

### Overwriting a stitch pattern combination

- > Create a stitch pattern combination.
- > Touch the icon «Personal memory».



- > Touch the icon «Save stitch pattern».
- > Select the stitch pattern combination which is to be overwritten.

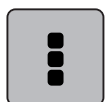


- > Touch the icon «Confirm» to overwrite the stitch pattern combination.

### Deleting a stitch pattern combination



- > Create a stitch pattern combination.
- > Touch the icon «i»-Dialog.



- > Touch the icon «Edit the complete combination».



- > Touch the icon «Delete».



- > Touch the icon «Confirm».

## 5.7 Administering stitch patterns

### Saving stitch patterns in personal memory

In the filing system «Personal memory» any stitch patterns, also those which have been individually edited, can be saved.

- > Select a stitch pattern, alphabet or buttonhole.
- > Edit the stitch pattern.
- > Touch the icon «Personal memory».



- > Touch the icon «Save stitch pattern».



- > Touch the icon «Confirm».

### Overwriting stitch patterns from the personal memory

Prerequisite:

- The stitch pattern is saved in the personal memory.
- > Select a stitch pattern, alphabet or buttonhole.
- > Edit the stitch pattern.
- > Touch the icon «Personal memory».



- > Touch the icon «Save stitch pattern».
- > Select the stitch pattern which should be overwritten.



- > Touch the icon «Confirm».

## Loading stitch patterns from the personal memory

Prerequisite:

- The stitch pattern is saved in the personal memory.



> Touch the icon «Personal memory».



> Touch the icon «Load stitch pattern».

> Select a stitch pattern.

## Deleting stitch patterns from the personal memory

Prerequisite:

- The stitch pattern is saved in the personal memory.



> Touch the icon «Personal memory».



> Touch the icon «Delete».

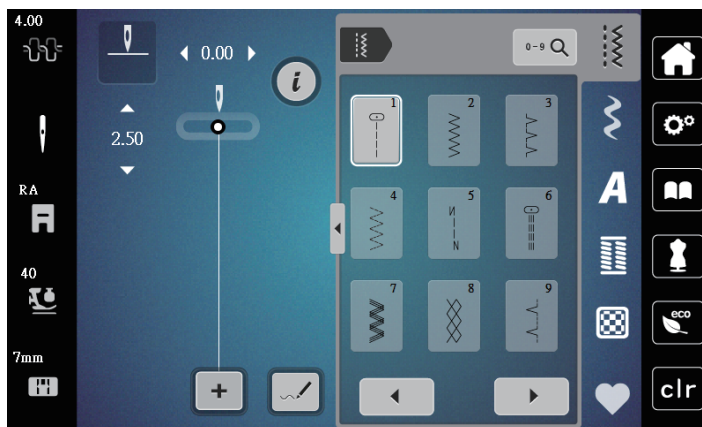
> Select a stitch pattern.



























> Touch the icon «Confirm».

## 6 Practical stitches

### 6.1 Overview Practical stitches



Stitch patterns	Stitch number	Name	Description
	1	Straight stitch	Seams and topstitching.
	2	Zigzag	Reinforcing seams, overcasting edges, sewing elastic seams and attaching lace.
	3	Vari overlock	Sewing and finishing in one step of elastic fabrics.
	4	Running stitch	Darning with running stitch, mending fabrics, reinforcing edges.
	5	Securing Program	Securing starts and ends of seams by straight stitching.
	6	Triple Straight stitch	Reinforced seams in heavy fabrics; visible hems and seams.
	7	Triple Zigzag	Reinforced seams in heavy fabrics; visible hems and seams.
	8	Honeycomb stitch	For stretch fabrics and hems. Is also used with elastic thread in the bobbin.
	9	Blindstitch	Blind hems, shell edging effect on soft jerseys and fine material, decorative seams.
	10	Double overlock	Sewing and finishing in one step of stretch fabrics.
	11	Superstretch stitch	For highly stretch fabrics. For all types of clothing.

Stitch patterns	Stitch number	Name	Description
	12	Gathering stitch	Most types of fabric; gathering with shirring elastic, butted seams = butting two pressed edges and sewing together, decorative stitches.
	13	Stretch overlock	Sewing and finishing in one step of stretch fabrics.
	14	Tricot stitch	Visible hems, visible seams in lingerie, sweaters, mending jersey.
	15	Universal stitch	For firm fabrics such as felt and leather. Flat joining seams, visible seams, attaching elastic, decorative seams.
	16	Sewn-out Zigzag	Edge finishing and reinforcing, attaching elastic, decorative seam.
	17	Lycra stitch	For lycra fabrics; flat joining seams and hems, reinforced seaming on underwear.
	18	Stretch stitch	For highly stretch fabrics; open seam for sportswear.
	19	Reinforced overlock	For medium-weight knitware and toweling. Overlock seams, flat joining seams.
	20	Knit overlock	Sewing and finishing in one step of hand and machine knitted fabrics.
	21	Basting stitch	For seams and hems.
	22	Simple Darning Program	Darning of holes and damaged fabric.
	23	Reinforced Darning Program	Reinforcing darning holes and damaged fabric.
	24	Bartack Program	Reinforcing pocket openings, sewing belt loops.

## 6.2 Sewing straight stitch



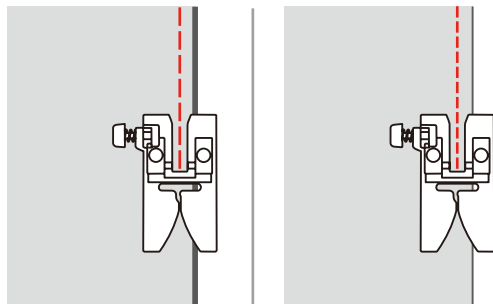
Match the stitch length with the sewing project, which means for denim fabrics long stitches (ca. 3 – 4 mm), for fine fabrics short stitches (ca. 2 – 2.5 mm). Match the stitch length with the thread size, e.g. long stitches when topstitching with Cordonnet (ca. 3 – 5 mm).

Prerequisite:

- The Zigzag foot (DA) is attached.



- > Touch the icon «Practical stitches».
- > Select the Straight stitch No.1.



## 6.3 Securing with the automatic Securing Program

Due to a determined number of 6 stitches sewn forward and 6 stitches sewn backward, the securing is regular.

Prerequisite:

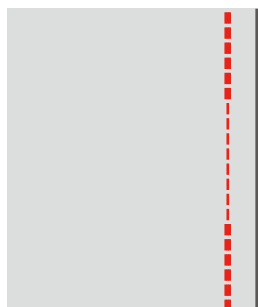
- The Zigzag foot (DA) is attached.



- > Touch the icon «Practical stitches».
- > Select the Securing Program No. 5.
- > Press the foot control.
  - The machine secures automatically.
- > Sew the seam in the desired length.



- > Push the button «Securing».
  - The machine secures automatically and stops at the end of the securing program.



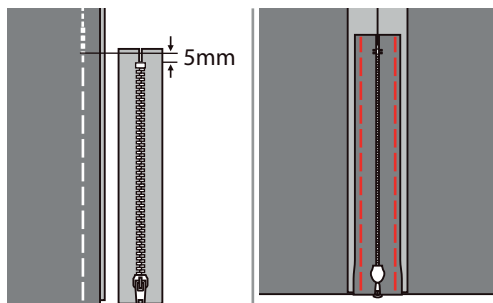
## 6.4 Sewing in the zipper



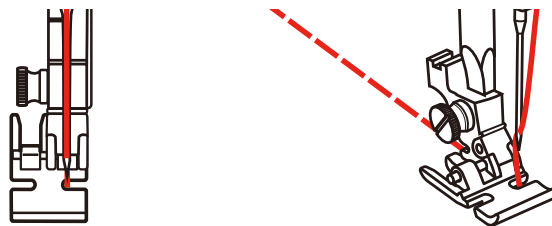
As the fabric feed can be difficult when starting to sew, it is recommended to hold the threads firmly or to pull the fabric slightly to the back for a few stitches or to sew 1 – 2 cm reverse first.



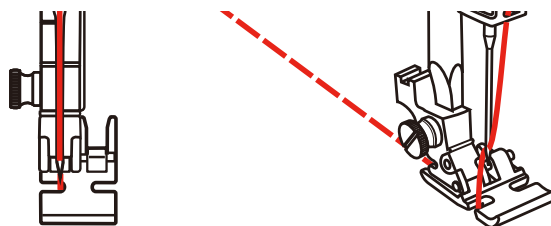
- > Attach the Zigzag foot (DA).
- > Touch the icon «Practical stitches».
- > Select the Straight stitch No. 1.
- > Close the zipper length with long stitches.
- > Finish the seam allowances individually.
- > Iron the seam apart.
- > Open the zipper length.
- > Baste the zipper under the fabric so that the fabric folded edges meet over the center of the zipper.



- > Attach the Zipper foot (JB).
- > When sewing the left side of the zipper, attach the right side of the presser foot pin to the holder.



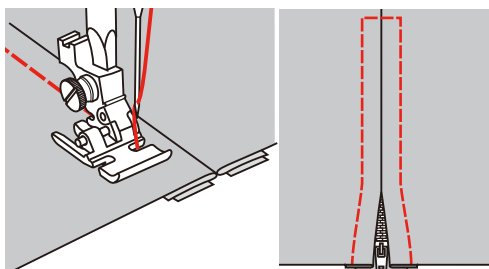
- > When sewing the right side of the zipper, attach the left side of the presser foot pin to the holder.



- > Sew the left side of the opened zipper from the top to the bottom.
- > Close the zipper to about 5 cm to the end.
- > Sew over the lower end and the right side of the zipper.
- > Stop in front of zipper slide with needle position down.
- > Open the zipper.
- > Finish sewing the right side.



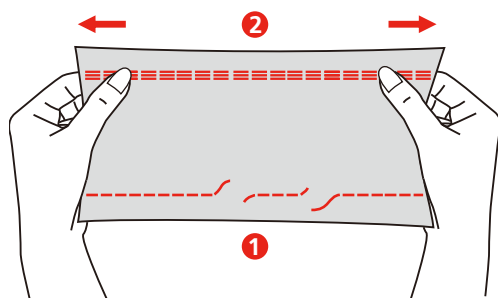
- > Remove the basting seam.



## 6.5 Sewing Triple straight stitch

The triple straight stitch is especially suitable for durable seams and for firm, densely woven fabrics such as denim and corduroy.

- > Attach the Zigzag foot (DA).
- > Touch the icon «Practical stitches».
- > Select the Triple straight stitch No. 6.



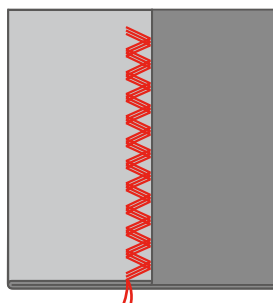
1 Straight stitch

2 Triple Straight stitch

## 6.6 Sewing Triple zigzag

For firm materials such as denim, deckchair covers, awnings or frequently washed items. Finish raw edges first. Seams on often washed items. Finish raw edges first.

- > Attach the Zigzag foot (DA).
- > Touch the icon «Practical stitches».
- > Select the Triple zigzag No. 7.

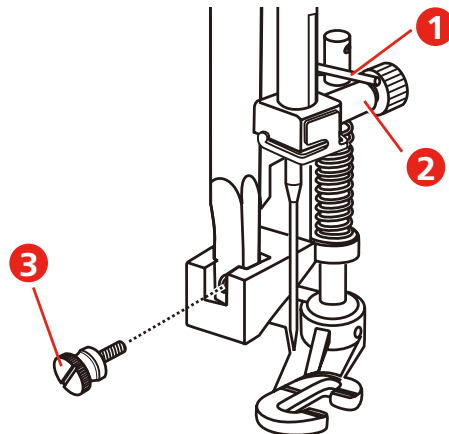


## 6.7 Manual darning

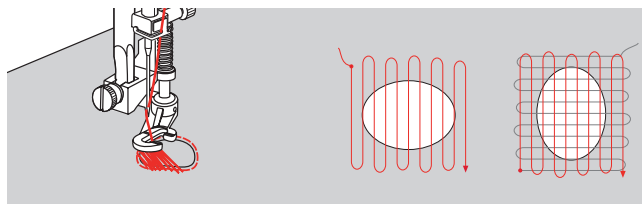
Used for darning holes or worn areas in all fabric types.

If the thread is lying on top and a poor stitch formation results, slow down the movement of the sewing project. If there are knots on the wrong side of the fabric, move the sewing project faster. When the thread breaks, guide the sewing project more consistently.

- > Remove the presser foot holder and attach the free motion foot (RX) to the presser foot holder bar.
  - The pin (1) of the Darning-/Embroidery foot should lay on the top of the needle clamp screw (2).
- > Press the free motion foot (RX) on firmly from behind with your index finger and tighten the screw (3).



- > Touch the icon «Practical stitches».
- > Select the Straight stitch No.1.
- > Lower the feed dog.
- > Attach the slide-on table.
- > Hoop the sewing project in the round embroidery hoop (optional accessory).
  - The darning area stays evenly taut and cannot be distorted.
- > Sew from the left to the right, guide the fabric evenly by hand without using pressure.
- > Move in curves when changing the direction to avoid holes and thread breakage.



## 6.8 Automatic darning and Reinforced darning

The simple Darning Program No. 22 is especially suitable for quick darning of worn or damaged areas. It is recommended to use fine material as a backing for the worn and damaged areas or to stick an adhesive interlining. The simple Darning Program No. 22 replaces threads along the lengthwise grain in all materials. If the darning area becomes distorted, correct with the balance.

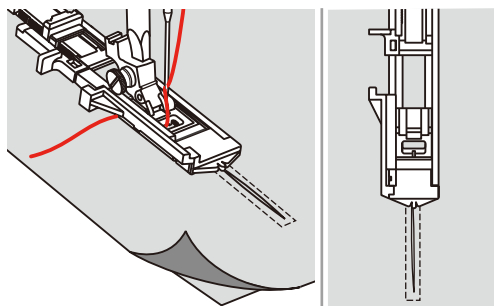
The reinforced Darning Program No. 23 is especially suitable for quick darning of worn or damaged areas. The reinforced Darning Program No. 23 replaces threads along the lengthwise or transverse grain in all materials.

Prerequisite:

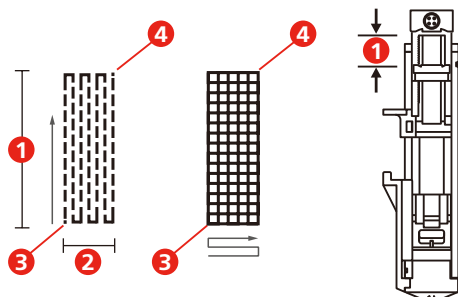
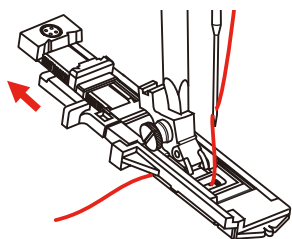
- The underlay material is fixed with basting stitches.
- > Attach the Buttonhole foot with slide (RJ).



- > Touch the icon «Practical stitches».
- > Select the reinforced Darning Program No. 23.
- > Lower the presser foot over the center of the tear.



- > Adjust the button holder on the buttonhole foot to the desired length. The size of one darning sequence is variable.
  - The maximum sewing length is 2.6 cm (1 inch) and the maximum sewing width is 7 mm (9/32 inch).

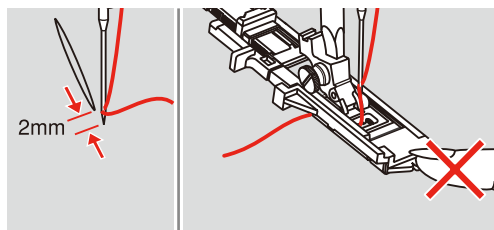


- |   |                      |   |       |
|---|----------------------|---|-------|
| 1 | The length of sewing | 3 | Start |
| 2 | The width of sewing  | 4 | Stop  |

- > Position the fabric so that the needle is 2 mm (1/16 inch) in front of the area to be darned.
- > Lower the presser foot.

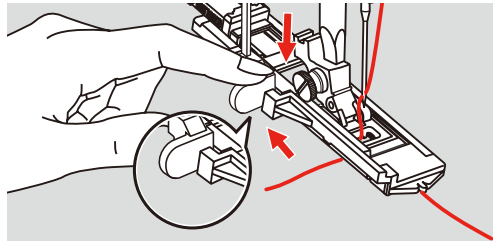


When lowering the presser foot, do not push the front of the presser foot, otherwise the darning will not be sewn in the correct size.

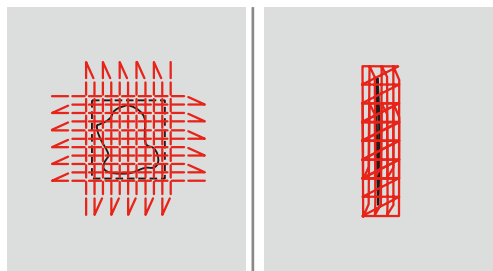


- > Lead the upper thread down through the hole in the presser foot.
- > Pull down the buttonhole lever as far as possible.
  - The buttonhole lever is positioned behind the bracket on the buttonhole foot.

- > Hold the end of the upper thread in your left hand, and then start sewing.



- > If the sewing range is too big to sew, then we recommend to sew the area several times (or cross sew) to get better sewing result.

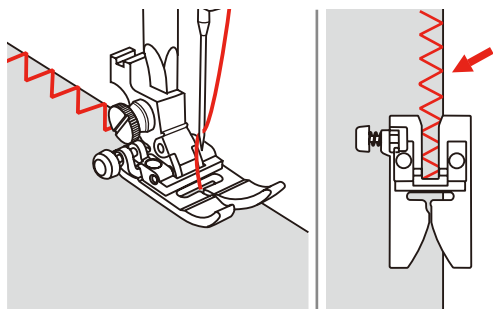


## 6.9 Finishing edges

The Zigzag No. 2 is suitable for all materials. It can also be used for elastic seams as well as for decorative sewing. Use darning thread for fine materials. When sewing satin stitch it is recommended to select a dense, short the zigzag with a stitch length of 0.5 – 0.7 mm. The satin stitch can be used for appliqué and for embroidering.

Prerequisite:

- The edge of the fabric should lie flat and not roll.
- > Attach the Zigzag foot (DA).
- > Touch the icon «Practical stitches».
- > Select the Zigzag No. 2.
- > Neither select too wide a stitch nor too long a stitch.
- > Guide the edge of the fabric into the center of the presser foot, so that the needle goes into the fabric on one side and over the edge into the air on the other side.



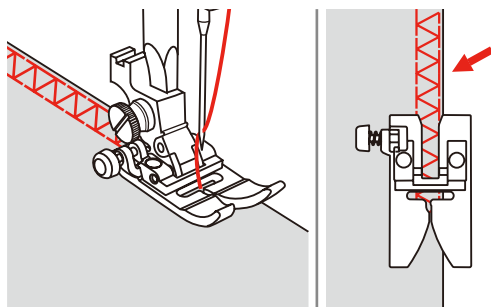
## 6.10 Sewing Double overlock

A double overlock seam is suitable for loose knits and cross seams in knits. When working with jersey, a jersey needle should be used to prevent damaging the knit fabric. When sewing stretch materials, use a stretch needle.

- > Attach the Zigzag foot (DA).



- > Touch the icon «Practical stitches».
- > Select the Double overlock No. 10.

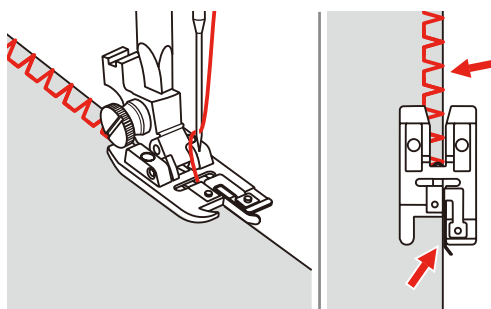


### 6.11 Sewing Vari overlock

Sewing overcasting stitches along the edges of fabric to prevent them from fraying.. When sewing stretch materials, use a stretch needle.



- > Attach the Overlock foot (DI).
- > Touch the icon «Practical stitches».
- > Select the Double overlock No. 3.
- > Sew the fabric with the fabric edge against the guide of the overcasting foot.

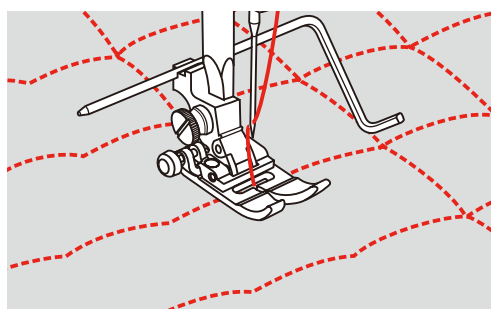


### 6.12 Edgestitching using the seam guide

When sewing parallel wider lines, it is recommended to guide the seam guide along the sewn of lines.



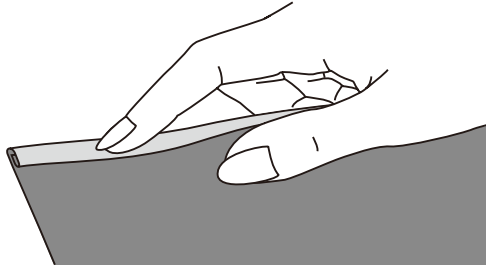
- > Attach the Zigzag foot (DA).
- > Touch the icon «Practical stitches».
- > Select the Straight stitch No.1.
- > Insert the seam guide into the hole of the presser foot.
- > Sew the first row and move over the fabric to sew subsequent rows with the guide riding along the previous row of stitching.



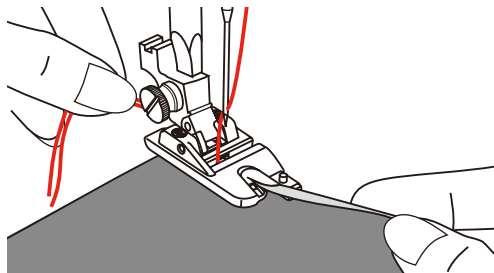
### 6.13 Sewing narrow hemming



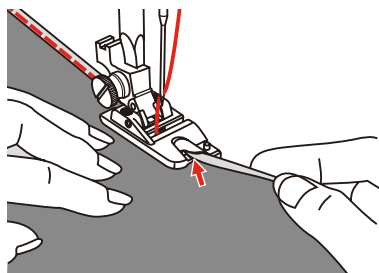
- > Attach the Hemmer foot (DG) Optional accessory.
- > Touch the icon «Practical stitches».
- > Select the Straight stitch No.1.
- > Fold the edge of the fabric over about 3 mm, then fold it over again 3 mm for about 5 cm along the edge of the fabric.



- > Position the needle in the fold by turning the handwheel towards you.
- > Lower the presser foot.
- > Sew several stitches and raise the presser foot.
- > Insert the fabric fold into the spiral opening of the hemmer foot.
- > Move the fabric back and forth until the fold forms a scroll shape.



- > Lower the presser foot.
- > Lower the presser foot and start sewing slowly guiding the raw edge of the fabric in front of the hemmer foot evenly into the opening of the foot.



### 6.14 Sewing blind hems

For invisible hems in medium to heavy weight cotton, wool and blended materials.

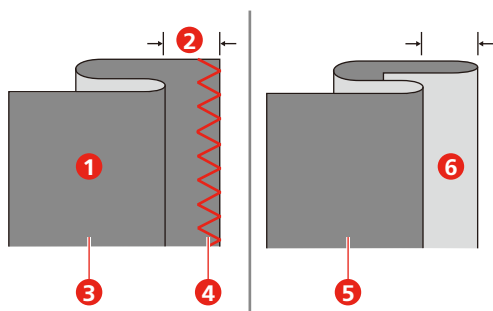
Prerequisite:

- The fabric edges are finished.



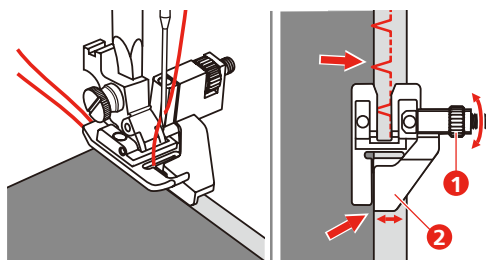
- > Attach the Blindstitch foot (DM).
- > Touch the icon «Practical stitches».
- > Select the Blindstitch No. 9.
- > Fold the fabric as illustrated with the wrong side up.

- > Place the fabric under the foot.

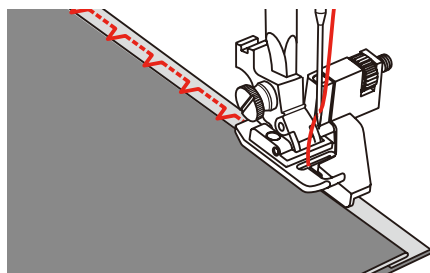


- |   |                          |   |                            |
|---|--------------------------|---|----------------------------|
| 1 | Wrong side of the fabric | 4 | Finished fabric edge       |
| 2 | 5 mm                     | 5 | Light/Medium-weight fabric |
| 3 | Heavy-weight fabric      | 6 | Right side of the fabric   |

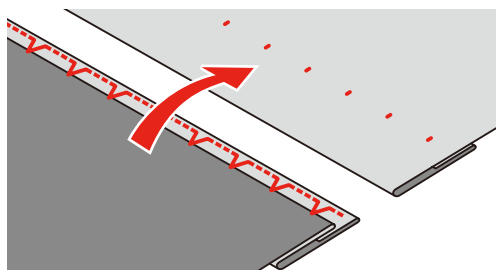
- > Turn the handwheel forwards by hand until the needle swings fully to the left.
- > It should just pierce the fold of the fabric. If it does not, adjust the stitch width accordingly.
- > Adjust the guide (2) by turning the knob (1) so that the guide just rests against the fold.



- > Sew slowly, guiding the fabric carefully along the edge of the guide.



- Turn over the fabric



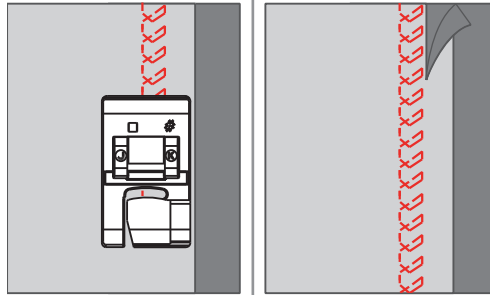
## 6.15 Sewing visible hems

The visible hem is particularly suitable for elastic seams in tricot made of cotton, wool, synthetic and mixed fibers.

- > Attach the Embroidery foot (JK).



- > Touch the icon «Practical stitches».
- > Select the Tricot stitch No. 14.
- > Iron the hem and baste if necessary.
- > Reduce the presser foot pressure if necessary.
- > Sew the hem in the desired depth on the right side.
- > Trim off the remaining fabric on the reverse side.



## 6.16 Sewing basting stitches

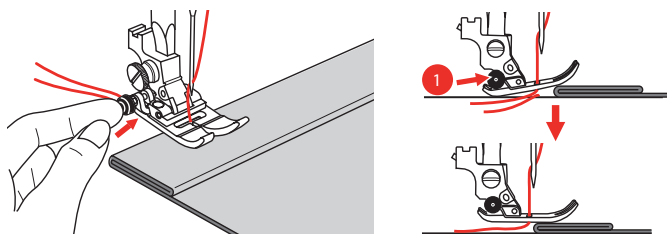
When sewing basting stitches, it is recommended to use a fine darning thread. This is easier to remove. The longest stitch possible is 5 mm. The recommended stitch length is 3.5 – 5 mm. The basting stitch is suitable for sewing projects where a very long stitch length is required.



- > Attach the Zigzag foot (DA).
- > Touch the icon «Practical stitches».
- > Select the Basting stitch No. 21.
- > Select the stitch length.
- > Pin the fabric layers at a right angle to basting direction to prevent the layers from slipping.
- > Sew 3 – 4 securing stitches at the beginning and at the end.

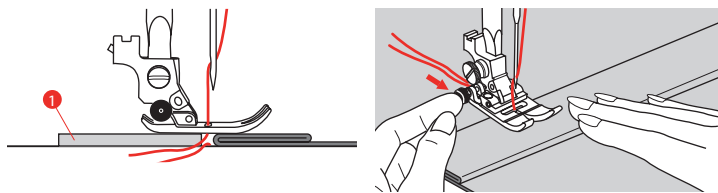
## 6.17 Sew thick areas

- > Attach the Zigzag foot (DA).
  - The black button on the left side of the presser foot will lock the presser foot in a horizontal position if you push it in before lowering the presser foot (1). This ensures even feeding at the beginning of a seam and helps when sewing multiple layers of fabric such as sewing over seams when hemming jeans.
- > When you reach the point of an increased thickness, lower the needle and raise the presser foot.
- > Press the toe of the foot and push in the black button, then lower the foot and continue sewing.
  - The black button releases automatically after sewing few stitches.





To support the presser foot while manually supplying and sewing towards the folded edge, place another piece of fabric with the same thickness on the backside of the seam.



1 Cardboard or thick fabric

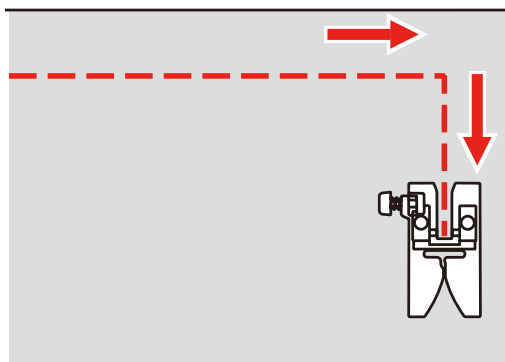
## 6.18 Sewing Corners



- > Stop the sewing machine when you reach a corner.
- > Lower the needle into the fabric manually or by pressing the «Needle up/down» button.



- > Raise the presser foot.
- > Use the needle as a pivot and turn the fabric.
- > Lower the presser foot and continue sewing.



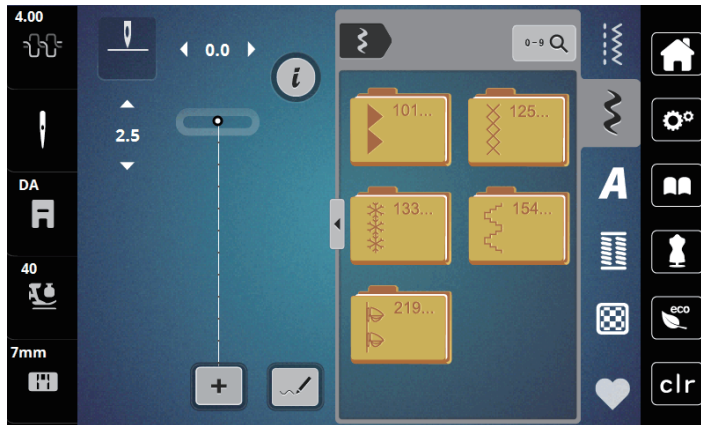
## 7 Decorative stitches

### 7.1 Overview Decorative Stitches

Depending on the type of material, simple or more complex decorative stitches should be selected to best suit the material.

- Decorative stitches which are programmed with simple straight stitches are particularly appropriate for light-weight materials, e.g. the Decorative stitch No. 142.
- Decorative stitches which are programmed with triple straight stitches or with a few satin stitches are particularly appropriate for medium-weight materials, e.g. Decorative stitch No. 152.
- Decorative stitches which are programmed with satin stitches are particularly appropriate for medium-weight materials, e.g. Decorative stitch No. 142.

For a perfect stitch formation it is of advantage to use the same thread color for upper and bobbin thread and a stabilizer. With pile or longfiber materials it is recommended to use an additional, water-soluble stabilizer on the right side which can be easily removed after sewing.



Decorative stitch	Stitch number	Name
	101-124	Satin stitches
	125-132	Cross stitches
	133-153	Floral stitches
	154-218	Ornamental stitches
	219-233	Novelty

## 7.2 Altering the stitch density

With satin stitches (e. g. No. 101) the stitch density can be altered. If the stitch density is increased, the stitch distance is enlarged. If the stitch density is decreased, the stitch distance is shortened. The programmed length of the stitch pattern is not affected.

- > Select the satin stitch.
- > Touch the icon «i»-Dialog.



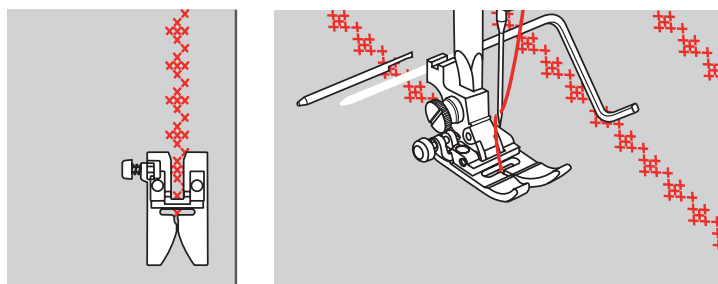
- > Touch the icon «Edit pattern length/stitch density».
- > Adjust the stitch density via the icons (1) «-» or «+».



## 7.3 Sewing cross stitches

Cross stitching is a traditional technique, and extends the range of decorative stitches. If the cross stitches are sewn on fabric with a linen texture, they look like hand-stitched cross stitching. When cross stitches are sewn with cotton embroidery thread, the stitch pattern appears fuller. Cross stitches are particularly used for home furnishing, trimmings on garments and embellishing in general. As every following line refers to the first row, it is important to stitch the first row in a straight line.

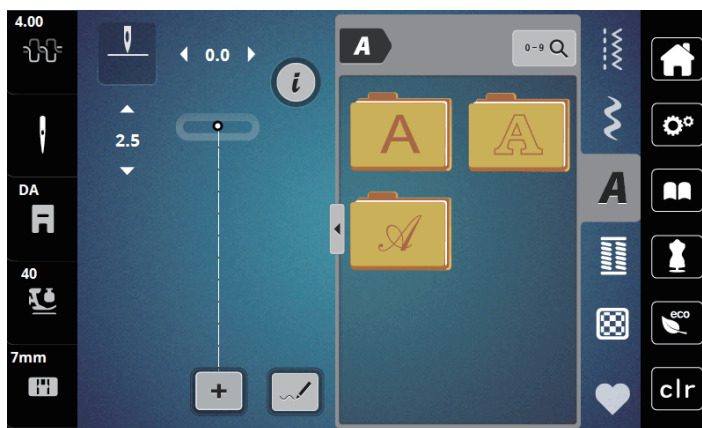
- > Attach the Zigzag foot (DA) or the Embroidery foot (JK) or the Open embroidery foot (DN) (optional accessory).
- > Select a cross stitch of the Decorative stitch No.125-132 and combine it as desired.
- > Stitch the first row using the seam guide to sew a straight line.
- > Stitch the second row next to the first at a distance of one presser foot's width or using the seam guide.



## 8 Alphabets

### 8.1 Overview Alphabet

Block, Double block and Script alphabets can be sewn in two different sizes, in upper and lower case letters. For a perfect stitch formation it is recommended to use the same thread color for upper and bobbin threads. The fabric can be reinforced with embroidery stabilizer on the wrong side. When working with pile or napped fabrics, e.g. toweling, use an additional, water-soluble stabilizer on the right side of the fabric.



Stitch patterns	Name
ABCabc	Block alphabet
ABCabc	Double-Block
<i>ABCabc</i>	Script (Italics)

### 8.2 Creating lettering



It is recommend to sew a test sample using the desired thread, the original fabric and the original stabilizer. Please make sure that the fabric is fed evenly and lightly without colloding and being caught. Do not pull, push or hold the fabric while sewing.



- > Touch the icon «Alphabets».
- > Select the font.



- > To create a combination, touch the icon «Single mode/Combi mode» (1).

- > To open the extended entry mode, touch the icon «Display alphabets» (2).



- > Select the letter.



- > To have more letters displayed, touch the icon «Scroll left» (3).



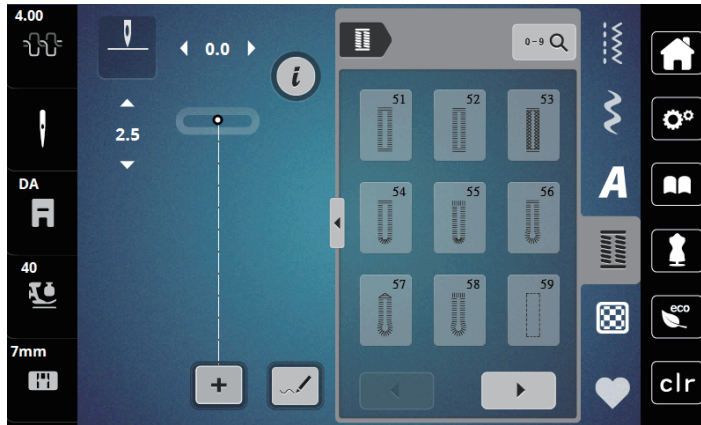
- > To delete individual letters of the entered text, touch the icon «DEL».
- > To close the extended entry mode, touch the icon «Display alphabets» (1) again.




















## 9 Buttonholes

### 9.1 Overview Buttonholes

To create the correct buttonhole for every button, every purpose and for every garment, the bernette b79 is equipped with a considerable collection of buttonholes. The corresponding button can be sewn on automatically. Eyelets can also be sewn.

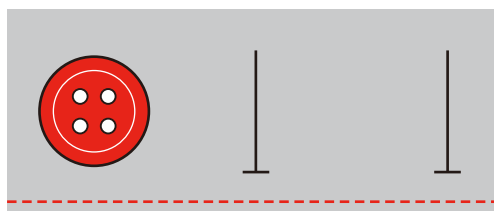


Buttonhole	Buttonhole number	Name	Description
	51	Standard buttonhole	For light to medium-weight fabrics blouses, dresses, bedlinen.
	52	Standard buttonhole narrow	For light to medium-weight fabrics blouses, dresses, children's and baby clothes, crafts.
	53	Stretch buttonhole	For any highly elastic jersey made from cotton, wool, silk and synthetic fibers.
	54	Round buttonhole with normal bartack	For medium to heavy-weight fabrics dresses, jackets, coats, rain wear.
	55	Round buttonhole with horizontal bartack	For medium to heavy-weight fabrics in all kinds of different materials; dresses, jackets, coats, rain wear
	56	Keyhole buttonhole	For firmer, non-stretch fabrics jackets, coats, leisure wear.
	57	Keyhole buttonhole with pointed bartack	For firm, non-stretch fabrics; jackets, coats, leisure wear.
	58	Keyhole buttonhole with horizontal bartack	For firm, non-stretch fabrics; jackets, coats, leisure wear.

Buttonhole	Buttonhole number	Name	Description
	59	Straight stitch buttonhole	Program for staystitching buttonholes, for pocket openings, reinforcing buttonholes, especially for buttonholes in leather and imitation leather.
	63	Heirloom	For light to medium-weight woven fabrics blouses, dresses, leisure wear, bedlinen.
	64	Double-rounded buttonhole	For medium to heavy-weight fabrics in all kinds of different materials.
	66	Buttonhole with double pointed bartack, narrow	Decorative buttonhole for medium weight fabrics blouses, dresses, jackets.
	69	Decorative buttonhole with double pointed bartack	For decorative buttonholes in firmer, non-elastic fabrics.
	71	Stretch buttonhole	For jeans or stretch fabric with a coarse weave.
	60	Button sew-on program	For buttons with 2 and 4 holes.
	61	Eyelets with small zigzag	Openings for cords and narrow ribbons, for decorative work.
	62	Straight-stitch eyelet	Openings for cords and narrow ribbons, for decorative work.

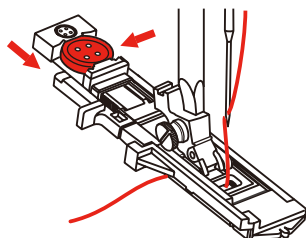
## 9.2 Marking buttonholes

- > Mark the positions of the buttonhole on the fabric.
  - The maximum buttonhole length is 3 cm (1 3/16 inch). (Total of diameter + thickness of button.)
- > The size of the buttonhole is determined by the button inserted in the buttonholder plate.

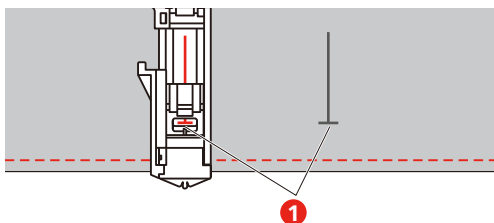


### 9.3 Sewing a buttonhole automatically

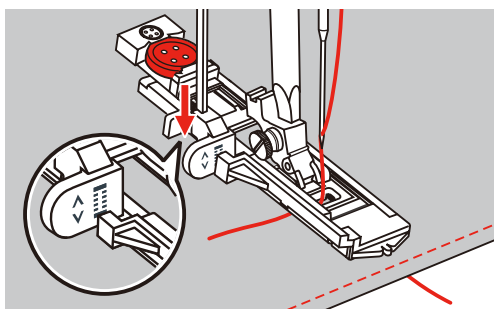
- > Attach the Buttonhole foot with slide (RJ).
- > Pull out the button holder plate and insert the button.
- > Pass the thread through the hole in the presser foot, then be placed the thread under the foot.
- > Touch the icon «Buttonholes».
- > Select the buttonhole.



- > Adjust the stitch width and the stitch length to the desired width and density.
- > Position the fabric under the presser foot so that the centerline's mark is aligned with the center of the buttonhole foot (1).

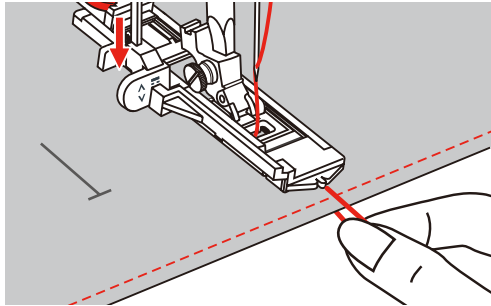


- > Push the button «Start/Stop».
  - While the buttonhole lever is raised, the error message is displayed to remind you to lower the buttonhole lever.
- > Pull down the buttonhole lever as far as possible until it clicks into place.

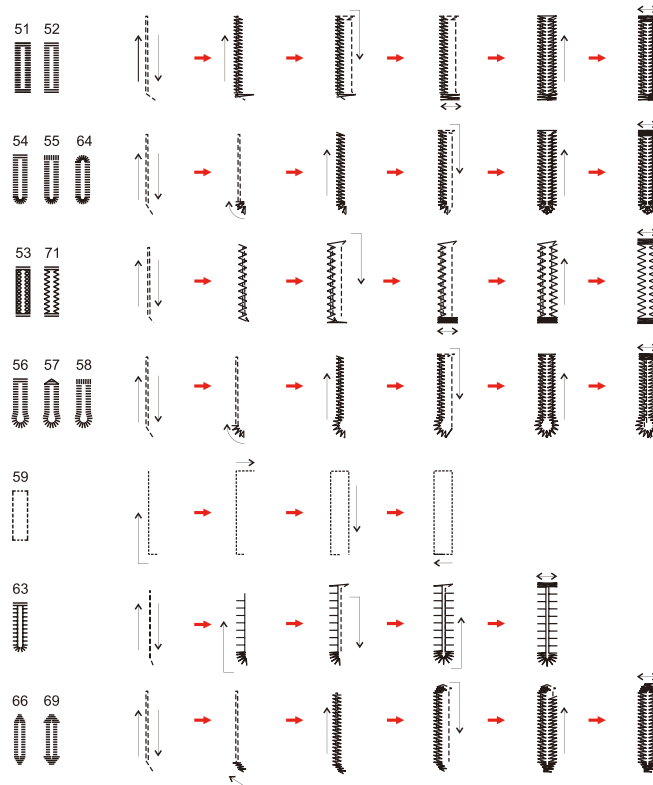




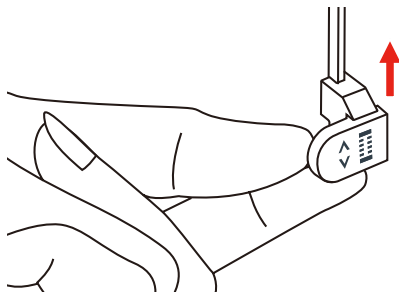
- > Hold the end of the upper thread in your left hand, and then start sewing.
- After the buttonhole has been sewn, the machine sews a securing stitch automatically and then stops.



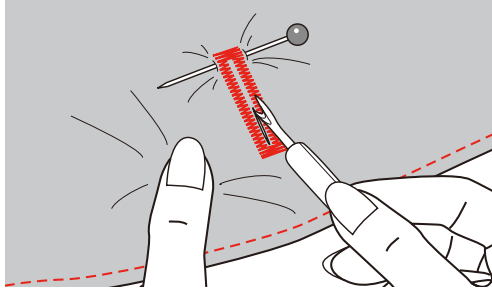
- Buttonholes are sewn from the front of the presser foot to the back, as shown.



- > Raise the presser foot and cut the thread.
- > After sewing the buttonhole, raise the buttonhole lever until it stops.



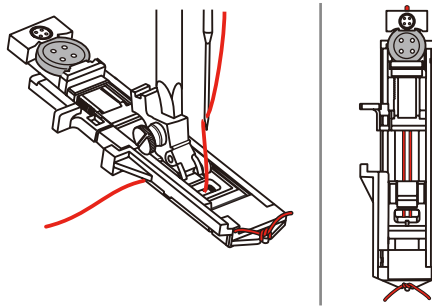
- > Cut the buttonhole and take care not to cut the beaded seam on both sides. Use a pin as a stopper at the bartack so you do not cut too much.



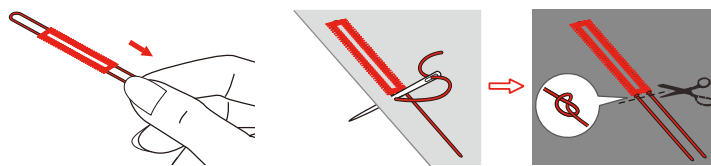
## 9.4 Reinforce buttonhole

When sewing buttonholes on stretch fabric, hook a heavy thread or a cord under the buttonhole foot.

- > Attach the Buttonhole foot with slide (RJ).
- > Pull out the button holder plate and insert the button.
- > Pass the thread through the hole in the presser foot, then be placed the thread under the foot.

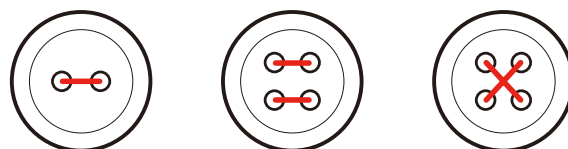


- > Bring the two cord ends to the front of the foot and insert them in the grooves, then temporarily tie them there.
- > The stitch width and stitch length has to be adjusted before the sewing starts.
- > Lower the presser foot and sew the buttonhole.
  - The buttonhole will sew over the cord, covering it.
- > Pull the cord through the buttonhole until the loop disappears in the bartack.
- > Pull the ends of the cord through to the wrong side of the fabric (using a hand stitching-needle), knot or secure with stitches.



## 9.5 Sewing on buttons

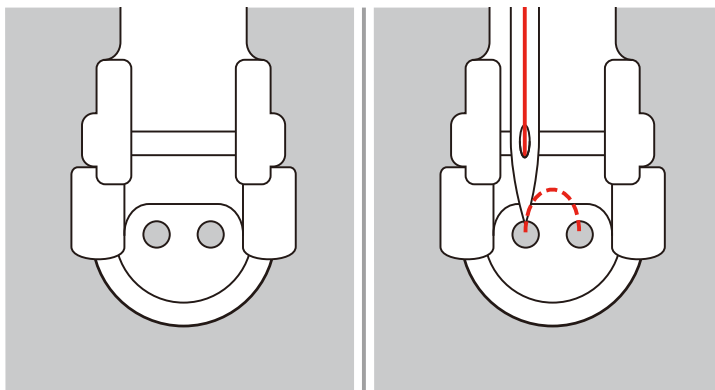
With the button sew-on program, buttons with 2 or 4 holes, push buttons or latches can be sewn on. For an increased stability the button sew-on program can be sewn twice. When sewing on a button with 4 holes, the front holes should be sewn first.



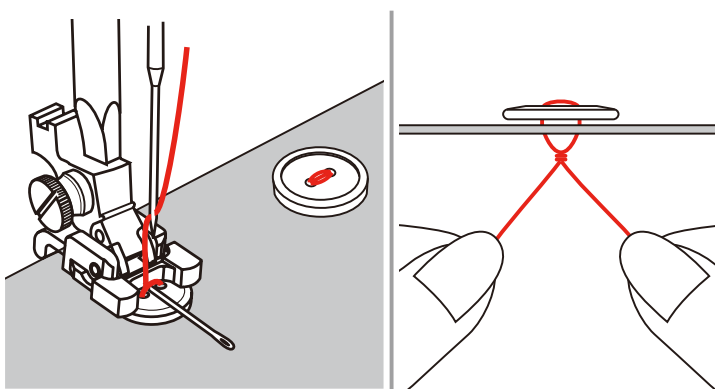
With the Button sew-on Program the first securing stitch is always stitched into the left hole of the button.



- > Attach the Button-sew-on foot (RC).
- > Touch the icon «Buttonholes».
- > Lower the feed dog.
- > Select the Button sew-on Program No. 60.
- > Place the button on the sewing project.
- > Check distances between holes with the handwheel. If necessary, alter the stitch width.



- > Hold the threads when starting to sew.
  - The machine sews the Button sew-on Program and stops automatically.
  - If a shank is required, place a darning needle on top of the button and sew.
- > Pull on both bobbin threads until the ends of the upper threads are visible on the wrong side.
- > Knot the ends manually.



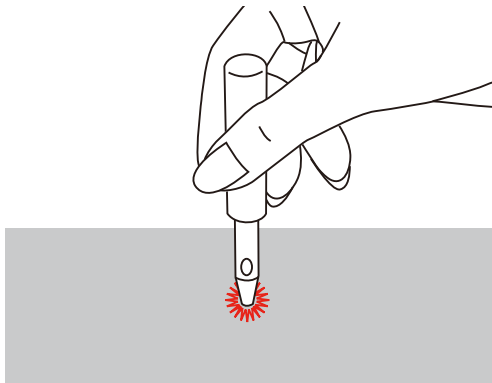
## 9.6 Sewing eyelets



For increased stability sew the eyelet twice.

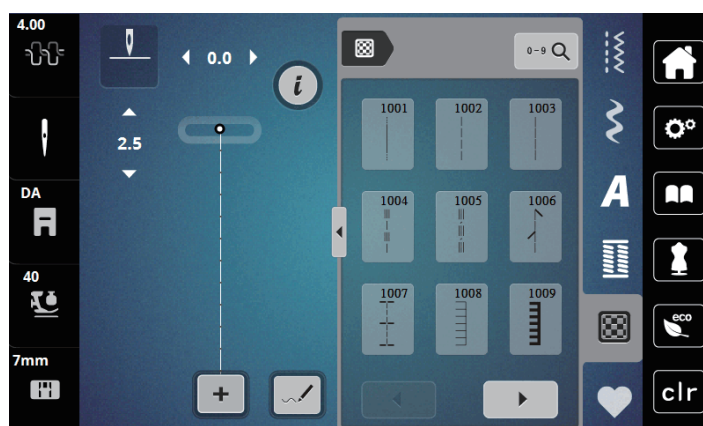


- > Attach the Zigzag foot (DA) or the Embroidery foot (JK) or the Open embroidery foot (DN) (optional accessory).
- > Touch the icon «Buttonholes».
- > Select the Eyelet Program No. 61 or No. 62.
- > Turn the «Upper Multifunction knob» or the «Lower Multifunction knob» to alter the size of the eyelet.
- > Sew the Eyelet Program.
  - The machine stops automatically at the end of the Eyelet Program.
- > Use an awl, punch pliers or a hole punch to open the eyelet.






## 10 Quilting

### 10.1 Overview Quilt Stitches



Stitch patterns	Stitch number	Name	Description
	1001	Quilting, Securing Program	To secure at the sewing start and sewing end with short stitches forward.
	1002	Quilting straight stitch	Straight stitch 2 mm stitch length, to join patchwork parts.
	1003	Piecing stitch/Straight stitch	Straight stitch at 3 mm stitch length.
	1004	Handlook quilt stitch 1005, 1030, 1034, 1035	Imitation of handlook quilt stitch with monofilament.
	1006	Decorative Quilt stitch variations 1007, 1010-1012, 1015-1019, 1025-1027, 1031-1032	For "Crazy Patchwork" and embellishing.
	1008	Blanket stitch	For appliqué and sewing on ribbons.
	1009	Double blanket stitch	For appliqué and sewing on ribbons.
	1013	Blanket stitch dual	To edgestitch between two appliqués, "Crazy Patchwork".
	1014	Double blanket stitch dual	To edgestitch between two appliqués, "Crazy Patchwork".

Stitch patterns	Stitch number	Name	Description
	1020	Feather stitch variations 1021-1023	For "Crazy Patchwork" and embellishing.
	1024	Stippling stitch	Imitation of stipple quilting.
	1029	Feather stitch 1028, 1033	For "Crazy Patchwork" and embellishing.

## 10.2 Quilting, Securing Program



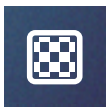
- > Attach the Zigzag foot (DA).
- > Touch the icon «Quilt stitches».
- > Select Quilt stitch pattern No. 1001.
- > Press the foot control.
  - The machine sews 5 stitches forward automatically when sewing is started.
- > Sew the seam in the desired length.



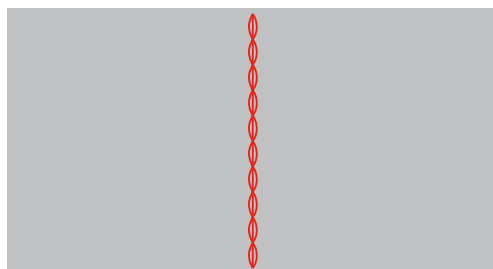
- > Push the button «Securing».
  - The machine sews 5 stitches forward automatically and stops automatically at the end of the Securing Program.

## 10.3 Sewing handlook quilt stitches

Handlook quilt stitches are suitable for all fabrics and sewing projects which should look hand sewn. It is recommended to use a monofilament thread as upper thread and an embroidery thread as bobbin thread. The sewing speed should be moderate to prevent the monofilament from breaking. If required, the upper thread tension and the balance can be adjusted to the sewing project and the desired quilt stitch.



- > Attach the embroidery foot (JK) / Zigzag foot (DA).
- > Touch the icon «Quilt stitches».
- > Select the Handlook quilt stitch No. 1004, 1005, 1030, 1034 or 1035.
- > If required, adjust the upper thread tension and the balance to the sewing project and the desired quilt stitch.
- > Press the foot control or the button «Start/Stop» to start the machine.



## 10.4 Guiding the quilt work freely



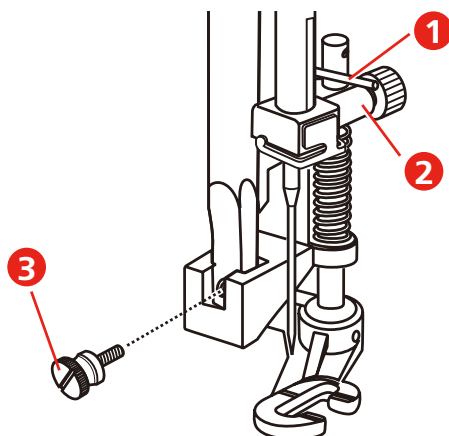
Quilt gloves with rubber fingertips (optional accessory) will help when guiding the fabric.

It is recommended to use the extension table (optional accessory) and the Free Hand System. With free-motion quilting, it is of advantage to quilt from the center outwards and to guide the fabric using smooth, round movements to form the design of your choice. Free-motion quilting and darning are based on the same free-motion principles.

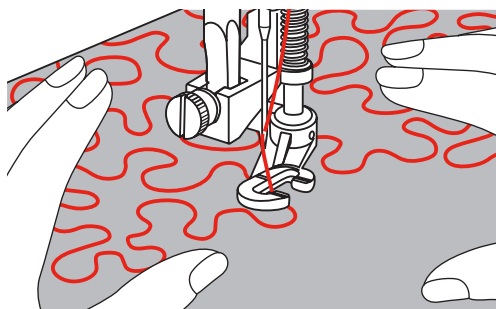
With stipple quilting, entire surfaces of the fabric are filled with quilt stitches. The single lines of stitching are rounded and never cross one another.

Prerequisite:

- The top layer, the batting and the backing are pinned together or basted.
- > Lower the feed dog.
- > Attach the free-motion embroidery foot (RX) to the presser foot holder bar.
  - The pin (1) of the Darning-/Embroidery foot should lay on the top of the needle clamp screw (2).
- > Press the free-motion foot on firmly from below with your index finger and tighten the screw (3).



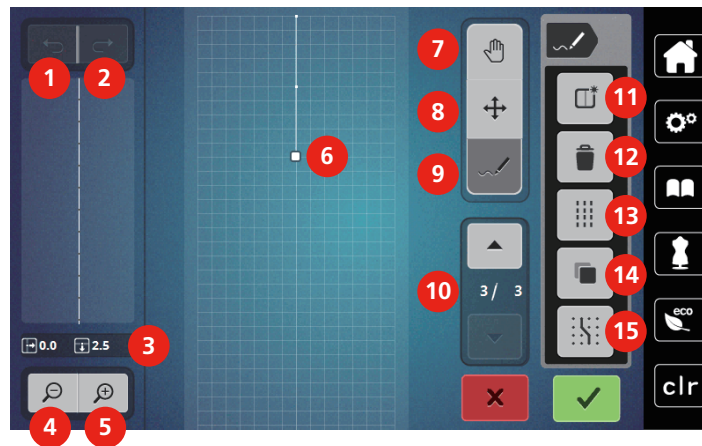
- > Touch the icon «Practical stitches».
- > Select the Straight stitch No. 1.
- > If necessary adjust the upper thread tension according to the sewing project.
- > Press the foot control or the button «Start/Stop» to start the machine.
- > Hold both hands close to the presser foot like an embroidery hoop to guide the fabric.
- > If the thread is lying on top of the fabric, slow down the movement.
- > If there are knots on the wrong side of the fabric, move the fabric more quickly.



## 11 Stitch Designer

### 11.1 Overview Stitch Designer

Buttonholes and darning stitches cannot be edited in the Stitch Designer.



- |   |                                    |    |                               |
|---|------------------------------------|----|-------------------------------|
| 1 | Back                               | 9  | Inserting/Editing a stitch    |
| 2 | Redo                               | 10 | Scrolling through points      |
| 3 | Point position                     | 11 | Creating a new stitch pattern |
| 4 | Zoom out                           | 12 | Deleting                      |
| 5 | Zoom in                            | 13 | Triple stitch                 |
| 6 | Stitch pattern view                | 14 | Duplicating                   |
| 7 | Moving the view                    | 15 | Engaging at the grid          |
| 8 | Relocating points/Selecting points |    |                               |

### 11.2 Creating your own stitch pattern



The stitch patterns which have been created in the Stitch Designer can be saved in your «Personal memory».

The Stitch Designer allows creating your personal stitch patterns as well as editing existing stitch patterns. By moving the touchscreen pen or the finger, your personal stitch patterns can be created on the display.

In the left portion of the display the position of the currently active point is indicated additionally: The horizontal distance of the point to the center line is indicated in millimeters. The vertical distance of the point to the previous point is also indicated in millimeters.

Buttonholes and darning stitches cannot be edited in the Stitch Designer.



- > Touch the icon «Stitch Designer».
  - The last active stitch pattern appears in the «Stitch pattern view» and can be edited.
  - The guides are displayed, the spacing is 0.5 mm.
  - The function «Inserting/Editing a stitch» is activated.



- > Touch the icon «Creating a new stitch pattern» to empty the «Stitch pattern view».
- > Add a point on the display with the touchscreen pen/finger.
- > Add more points on the display as desired.



- > If a stitch design ends with reverse stitches or is a closed shape, a forward stitch must be inserted on the same vertical axis as the first stitch so that the design can be sewn continuously.
  - In the preview window in the left display portion it can be seen whether or not a stitch design is sewn continuously.



- > Touch the icon «Confirm».
  - The stitch design is displayed and can be sewn.
  - More than 3 mm of the line point will average allocate the next point distance automatically.

### Creating stitch designs using screen dots



- > Touch the icon «Grid on/off» to display the center of the hoop on the display.
  - Every inserted point is automatically placed on the nearest grid point.

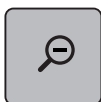
### Free hand drawing

- > Using the finger or the touchscreen pen, touch the stitch pattern view and draw a stitch design.

### 11.3 Editing the view



- > Select a stitch pattern, alphabet or buttonhole.
- > Touch the icon «Stitch Designer».



- > Touch the icon «Zoom out» to minimize the view of the stitch pattern.



- > Touch the icon «Zoom in» to enlarge the downsized stitch pattern view.



- > Touch the icon «Move the view».
- > Move the view of the stitch pattern using the touchscreen pen/finger.

### 11.4 Inserting points

A new point is inserted after a current position indicated by a white dot.



- > Select a stitch pattern or alphabet.
- > Touch the icon «Stitch Designer».



- > Touch the icon «Engaging at the grid» to have the grid points displayed.
  - Every inserted point is automatically placed on the nearest grid point.



- > Touch the icon «Scroll up»/«Scroll down» to select the point.
- > Touch the desired position in the «Stitch pattern view» with the touchscreen pen/finger.
  - The new point is inserted after the selected point and can be moved to the desired position with the multifunction knobs.



- > Touch the icon «Back» to undo the last work step.
- > Touch the icon «Redo» to restore the last work step.

### 11.5 Relocating the points

- > Select a stitch pattern or alphabet.



> Touch the icon «Stitch Designer».



> Touch the icon «Relocating points/Selecting points».  
> Touch the desired point in the stitch pattern view to select the point.



> Touch the icon «Scroll up» to add the previous point to the selection.



> Touch the icon «Scroll down» to add the following point to the selection.  
> Turn the «Upper Multifunction knob» to relocate the selected points horizontally.  
> Turn the «Lower Multifunction knob» to relocate the selected points vertically.

## 11.6 Duplicating points



> Select a stitch pattern or alphabet.  
> Touch the icon «Stitch Designer».



> Touch the icon «Relocating points/Selecting points».  
> Touch the desired point in the stitch pattern view to select the point.



> Touch the icon «Scroll up» to add the previous point to the selection.



> Touch the icon «Scroll down» to add the previous point to the selection.



> Touch the icon «Duplicate».  
– All selected points are duplicated.  
– The direction, type and length of the activated points are transferred.

## 11.7 Deleting points



> Select a stitch pattern or alphabet.  
> Touch the icon «Stitch Designer».



> Touch the icon «Relocating points/Selecting points».  
> Touch the desired point in the Stitch pattern view to select the point.



> Touch the icon «Scroll up» to add the previous point to the selection.



> Touch the icon «Scroll down» to add the following point to the selection.



> Touch the icon «Delete» to delete all the selected points of the stitch pattern.

## 11.8 Activating the triple stitch



- > Select a stitch pattern or alphabet.
- > Touch the icon «Stitch Designer».



- > Touch the icon «Relocating points/Selecting points».
- > Touch the desired point in the Stitch pattern view to select the point.



- > Touch the icon «Scroll up» to add the previous point to the selection.



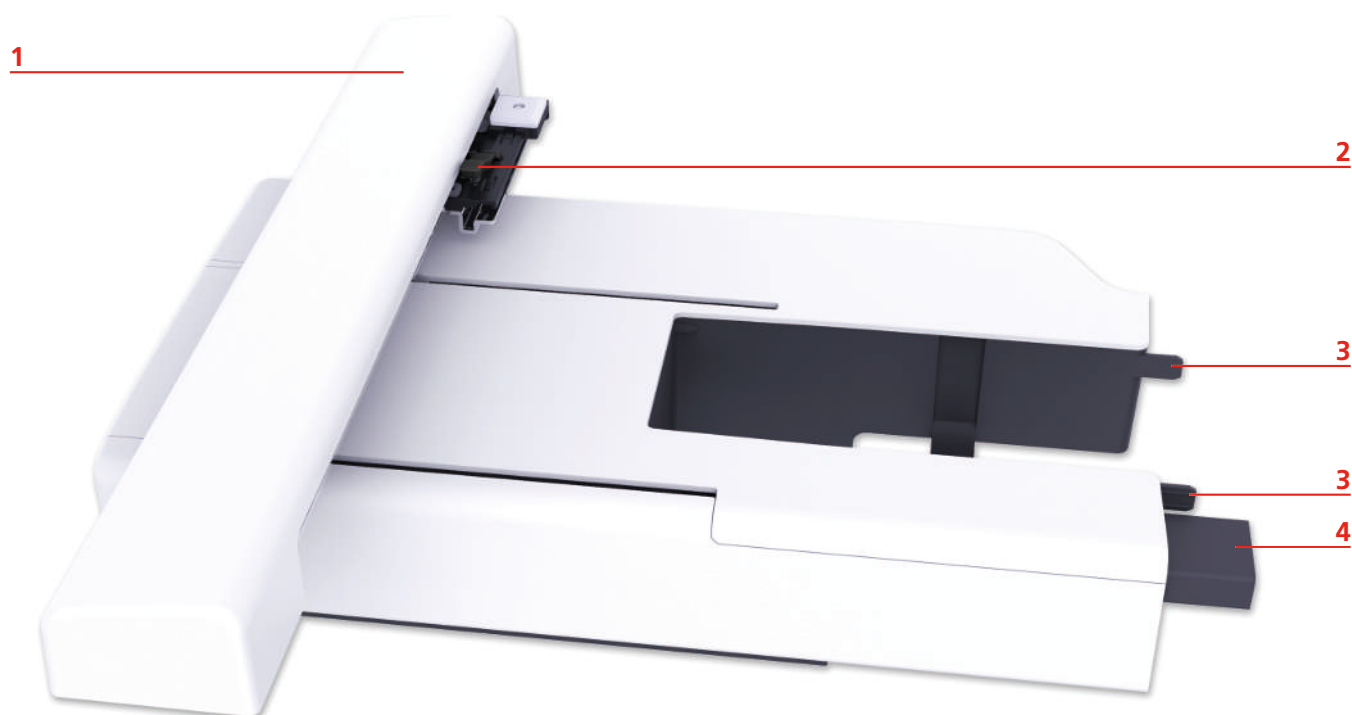
- > Touch the icon «Scroll down» to add the following point to the selection.



- > Touch the icon «Triple stitch» to activate the triple stitch for the selected points.
  - If only one point is selected, the stitch in front of the selected point is activated.
- > Touch the icon «Triple stitch» again to deactivate the triple stitch for the selected points.

## 12 My bernette Embroidery

### 12.1 Overview Embroidery module

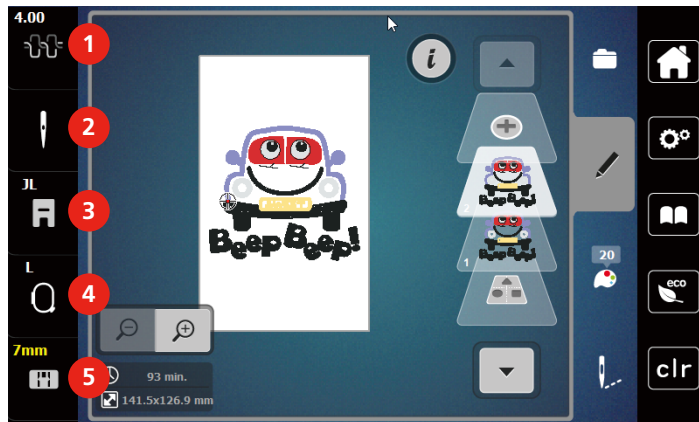


- |   |   |   |                                |
|---|---|---|--------------------------------|
| 1 | Embroidery arm                            | 4 | Connection to the machine      |
| 2 | Bracket for attaching the embroidery hoop | 5 | Embroidery unit release button |
| 3 | Guide rails for the machine               |   |                                |



## 12.2 Overview User Interface

### Overview functions/visual information



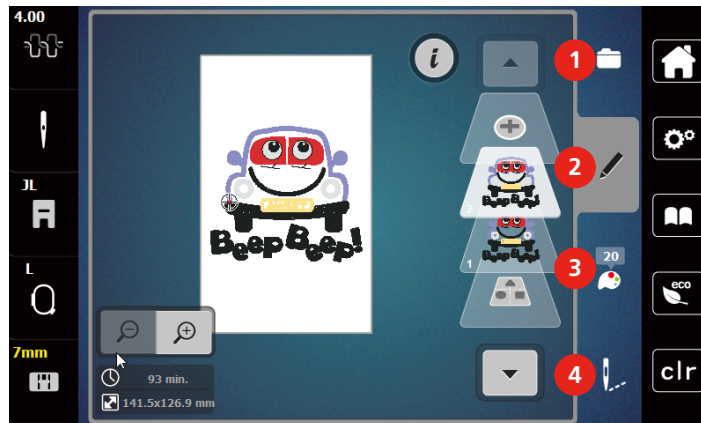
- |   |                      |   |   |
|---|----------------------|---|---|
| 1 | Upper thread tension | 4 | Embroidery hoop display/Embroidery hoop selection |
| 2 | Needle selection     | 5 | Stitch plate selection                            |
| 3 | Presser foot display |   |   |

### Overview System settings



- |   |               |   |                         |
|---|---------------|---|-------------------------|
| 1 | Home          | 4 | eco mode                |
| 2 | Setup Program | 5 | Back to default setting |
| 3 | Tutorial      |   |                         |

## Overview Selection menu embroidery



- |   |                             |   |                   |
|---|-----------------------------|---|-------------------|
| 1 | Selection embroidery motifs | 3 | Color information |
| 2 | Editing embroidery motifs   | 4 | Embroidery        |

## 12.3 Important Embroidery information

### Upper thread

A good quality thread (brand manufacturer) is essential for embroidery so that the embroidery is not affected negatively because of poor thread or thread breakage.

Embroidery is particularly effective if you use 40wt glossy rayon or polyester embroidery threads as upper threads. They are available in a wide range of colors for beautiful embroidery.

- Glossy polyester with a brilliant sheen is a hard wearing, colorfast thread and has a high tensile strength which is suitable for all types of embroidery.
- Rayon is a soft viscose fiber with a brilliant sheen and suitable for fine, delicate embroidery, or items that will not receive excessive wear and tear.
- Metallic thread is a light to medium-weight thread suitable for special effects in embroidery.
- When working with metallic threads, the automatic bobbin thread cutter should be deactivated. The other thread cutters shouldn't be used either because the knives are likely to wear off very quickly.
- When using metallic threads, the speed and the upper thread tension should be reduced.



### Bobbin thread

In most cases black or white bobbin thread is used for embroidering. When both sides should have the same look, it is recommended to use the same color for bobbin and upper thread.

- Bobbin Fill is an especially soft and light polyester thread which is suited well to be used as bobbin thread. This special bobbin thread ensures a steady thread tension and an optimal intertwining of the upper and bobbin thread.

- Darning and embroidery threads are fine mercerized cotton threads which are suitable for embroidery on cotton.



### Choosing the embroidery motif

Simple motifs with a low stitch count are suitable for embroidery on fine material. Densely embroidered motifs, e. g. embroidered motifs with multiple color and embroidery direction changes, are suitable for medium and heavy-weight material.

### Embroidery test

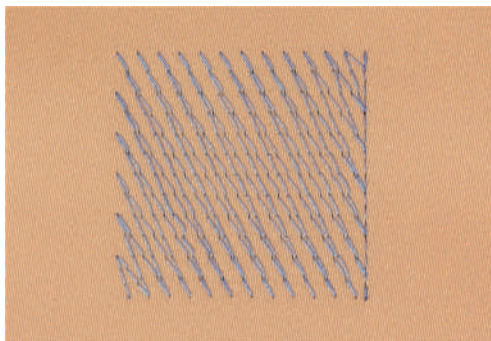
For the embroidery test, always use the original material reinforced with the same stabilizer as will be used later. For the embroidery test it is recommended to use the same colors, threads and needles which are planned to be used for the embroidery project.

### Embroidering motifs by third-party providers

bernette recommends uploading embroidery motifs of any file format via the free program «ART-Link» to the machine or a USB stick. Using «ART-Link» ensures that the embroidery motif can be read and embroidered correctly. «ART-Link» can be downloaded for free at [www.bernette.com](http://www.bernette.com).

### Underlay stitches

Underlay stitches are the foundation of a motif and are used to stabilize the base material and hold it in shape. They also prevent the covering stitches of the motif from sinking into the knit or the nap of the material.

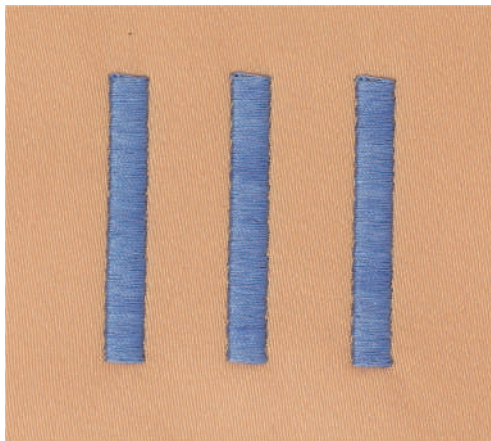


### **The size of the embroidery motif**

Embroidery motifs can be enlarged or downsized on the embroidery machine or on the PC using the BERNINA Embroidery software (optional accessory). Enlargements or reductions up to 20% achieve the best results.

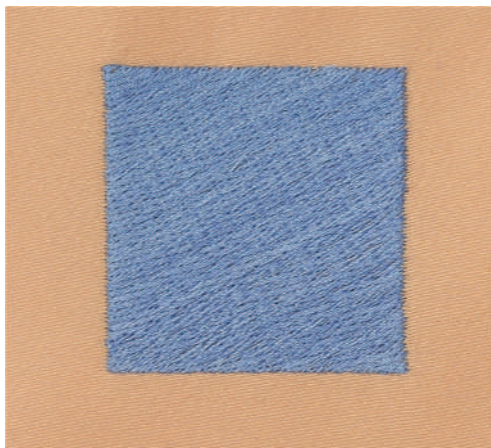
### **Satin or Leaf stitch**

The needle moves left to right and vice versa. The result is a very dense, covering zig zag stitching to fill the shape. Satin stitching fills are ideal for narrow and small shapes. Satin stitching is, however, not suitable for larger areas, since wide stitches are too loose and do not cover the fabric properly. In addition there is the risk that with too long stitches the threads could catch on something which would damage the embroidery.



### **Step stitch**

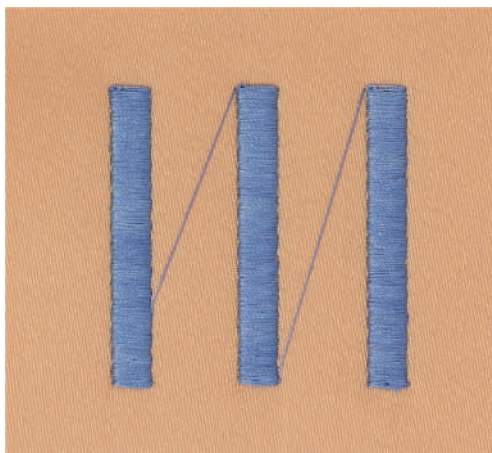
Many short, equally long stitches are embroidered in offset rows closely next to each other which results in a densely filled area.





## Connecting stitches

Long stitches which are used to get from one part of the motif to the next. Before and after the connecting stitch securing stitches are sewn. Connecting stitches are trimmed.



## 13 Embroidering preparation

### 13.1 Attaching the Module

**NOTICE**

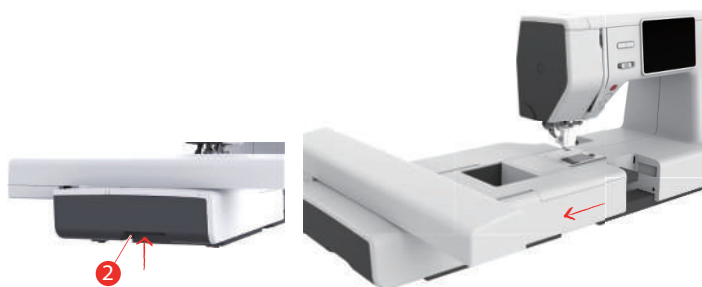
#### Transporting the embroidery module

Damage to the embroidery module connection and machine.

- > Remove the embroidery module before transporting the machine.
- 
- > Make sure that the module and the machine are placed on a stable, even surface.
  - > Make sure that there is enough space around to allow the unimpeded movement of the embroidery arm.
  - > Lift the embroidery module on the left.
  - > Carefully push the module from left to right into the embroidery module connection (1) of the machine so that it engages.



- > Hold the embroidery module, press the release button and pull it out.



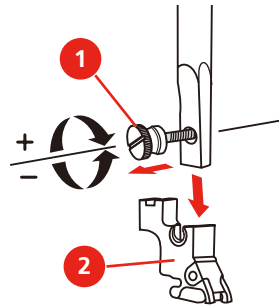
### 13.2 Embroidery foot

#### Attaching the embroidery foot

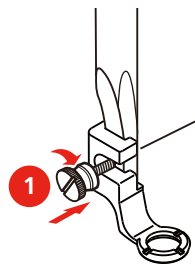
Mount the embroidery foot

- > Raise the needle.
- > Raise the presser foot and dual feed.
- > Switch the machine off and disconnect it from the power supply system.

- > Remove the presser foot holder (2) by unscrewing the presser foot bar attaching screw (1).

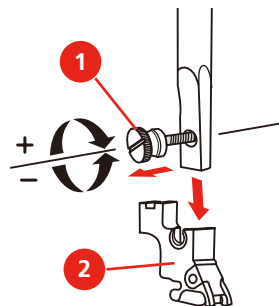


- > Attach the embroidery foot (JL) from the back with the index finger to the presser foot bar and tighten the screw.

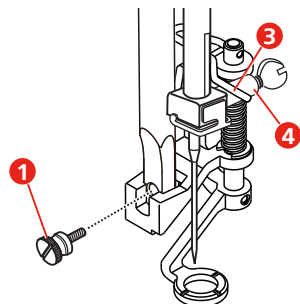


Mount the hopper embroidery foot

- > Raise the needle.
- > Raise the presser foot and dual feed.
- > Switch the machine off and disconnect it from the power supply system.
- > Remove the presser foot holder (2) by unscrewing the presser foot bar attaching screw (1).



- > Mount the hopper embroidery foot (JX) on the presser foot rod, making sure that the spring (3) is above the needle fixing screw (4).
- > Tighten the screw (1).



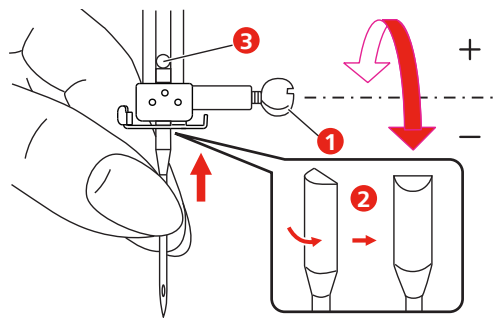
## 13.3 Needle and stitch plate

### Inserting the embroidery needle



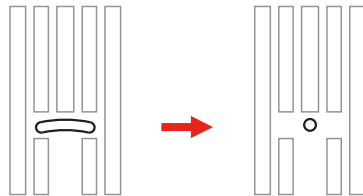
Embroidery needles of the type 130/705 H-SUK provide a larger eye and are slightly rounded. This avoids thread abrasion when using Rayon- and cotton embroidery thread. Depending on the embroidery thread use a size No. 70-SUK to No. 90-SUK needle.

- > Raise the needle.
- > Switch the machine off and disconnect it from the power supply system.
- > Remove the attached foot.
- > Loosen the needle clamp screw (1) using the screwdriver and remove the needle.
- > Hold the needle with the flat side (2) to the back.
- > Insert the needle as far up as it will go (3).
- > Tighten the needle clamp (1) screw using the screwdriver.



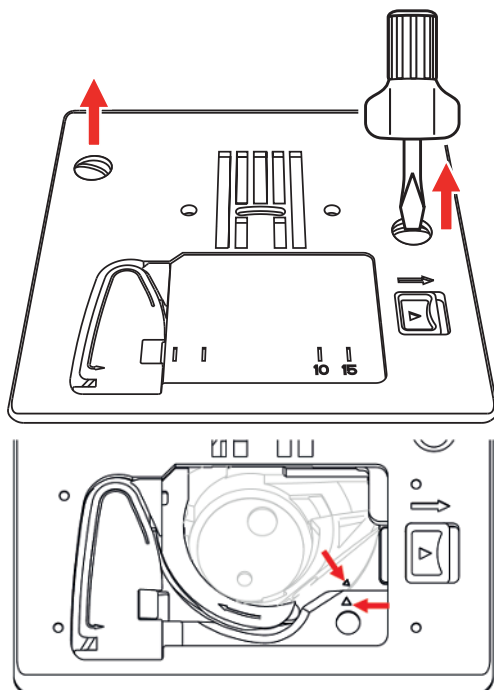
### Attaching the stitch plate (CutWork/Straight)

The Straight/Cutwork stitch plate has a small hole in the area of the needle. The thread draw-in (thread knotting of upper thread and bobbin thread) is therefore optimized. This results in a nicer stitch formation.

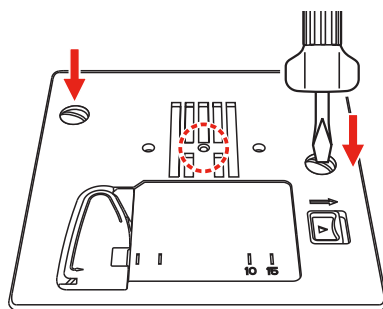


- > Switch the machine off and disconnect it from the power supply system.
- > Remove the needle.
- > Remove the presser foot.
- > Lower the feed dog and remove the bobbin cover.
- > Remove the screws of the stitch plate with the screwdriver.

- > Remove the stitch plate.



- > Change the Straight/Cutwork stitch plate and tighten the screws with the screwdriver.



**Note:** The markings of the bobbin holder and the stitch plate must be aligned in the same way.

### 13.4 Selecting the embroidery motif

All embroidery motifs can be embroidered directly or they can be altered using the various functions the embroidery machine provides. You can find all embroidery motifs at the end of the instruction manual. In addition to that, embroidery motifs can be downloaded from the personal memory or from the USB stick (optional accessory).

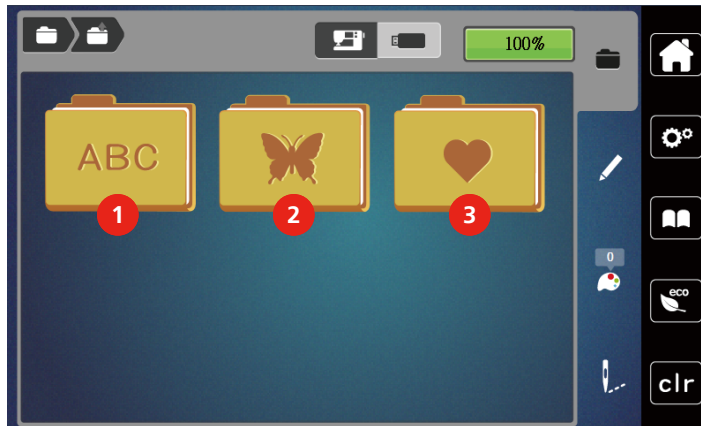


- > Touch the icon «Home».



- > Touch the icon «Embroidery mode».

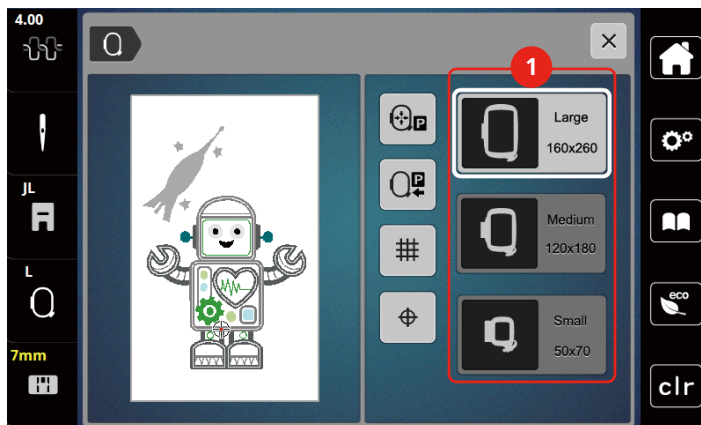
- > Select an alphabet, an embroidery motif, a stitch pattern or a personal embroidery motif from one of the files.



- 1 Embroidery Alphabet
- 2 Embroidery motif
- 3 Personal Embroidery motif

## 13.5 Embroidery hoop

### Overview embroidery hoop selection



- 1 Hoop selection

### Selecting the embroidery hoop

The best embroidery result is achieved when the smallest possible embroidery hoop for the embroidery motif is selected.

The embroidery motif has a pre-set size which is displayed.

Prerequisite:

- The embroidery motif is selected.



- > Touch the icon «Embroidery hoop display/Embroidery hoop selection».
  - The presently attached embroidery hoop is displayed.
  - The machine selects the optimal embroidery hoop according to the size of the embroidery motif automatically.
  - If the preset embroidery hoop is not available, another desired embroidery hoop can be selected.
  - When an embroidery hoop is attached which does not correspond with the selected one, the attached hoop is considered active and the embroidery motif area is displayed accordingly.
- > Select the desired embroidery hoop.

### **Tear-away stabilizers**

Using a stabilizer ensures more stability of the embroidery project. A tear-away stabilizer suits all woven and non-stretch materials. 1 – 2 layers can be used. Stabilizers are available in different weights. With larger embroidered areas the stabilizer will remain under the embroidery thread. The stabilizer is applied to the wrong side of the fabric with temporary adhesive spray. Carefully tear away excess stabilizer after embroidering.

### **Cut-away stabilizers**

Using a stabilizer ensure more stability of the embroidery project. A cut-away stabilizer suits all elastic materials. 1 – 2 layers can be used. Stabilizers are available in different weights. With larger areas to be embroidered the stabilizer will remain under the embroidery thread. The stabilizer is applied to the wrong side of the fabric with temporary adhesive spray. Carefully cut away excess stabilizer after embroidering.

### **Using adhesive spray**

The application of spray adhesive is recommended for stretch and smooth materials and knitware. It prevents the fabric from losing shape and slipping. Appliqués can be exactly positioned with spray adhesive. The spray adhesive shouldn't be used near the machine to avoid contamination.

- > Use the adhesive spray carefully at a distance 25 – 30 cm (9 – 12 inch) when spraying the stabilizer.
- > Adhere the sprayed stabilizer to the wrong side of the fabric carefully, smoothing material so there are no puckers.
- > Position smaller parts such as pocket flaps or collars on the stabilizer.
- > To avoid the possibility of getting hoop marks when working with napped materials or fleece, don't hoop the parts but spray the stabilizer and hoop it.
- > Adhere the fabric to be embroidered.
- > Remove any adhesive residue before starting the machine.

### **Using spray starch**

Spray starch is ideal for additional stiffening fine, loosely woven materials. Always use an additional stabilizer on the wrong side of the material.

- > Spray the area to be embroidered.
- > Let it dry or press gently with a warm iron if necessary.

### **Using iron-on interfacing**

Iron-on interfacings are available in a variety of weights. It is recommended to use an iron-on interfacing which is easily removable from the basic fabric. An Iron-on interfacing suits all materials that are easily distorted like stretch fabric such as tricot and jersey.

- > Iron-on interfacings are ironed to the wrong side of the material using a warm iron.

### **Using paper-backed adhesive stabilizer**

Paper-backed adhesive stabilizers are intended to be used for fabrics such as jersey and silk as well as for embroidery projects which are not suited to be hooped in the embroidery hoop.

- > Place the stabilizer in the hoop, so that the paper side is up.
- > Use a pair of scissors to score the paper and remove paper in the hoop area.
- > Position the fabric to be embroidered on the stabilizer and press it on place.
- > Remove any adhesive residue before starting the machine.

### Using water-soluble stabilizer



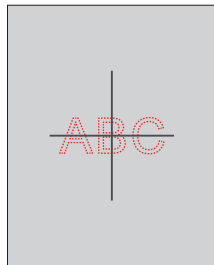
For lace embroidery it is recommended to hoop 1 – 3 layers of water-soluble stabilizer in the embroidery hoop. As the embroidery motif is not embroidered on the fabric, only the thread embroidered motif is left. The embroidery motifs should be combined with short stitches otherwise the individual motifs may fall out.

Water-soluble stabilizers are ideal for fine, sheer fabrics where other stabilizers may show through the embroidery stitches as well as for lace embroidery. The stabilizer dissolves in water. Water-soluble stabilizers are an ideal protection for looped pile fabrics preventing the loops from being damaged. It prevents threads from sinking into the material and keeps the fabric pile from poking through the embroidery.

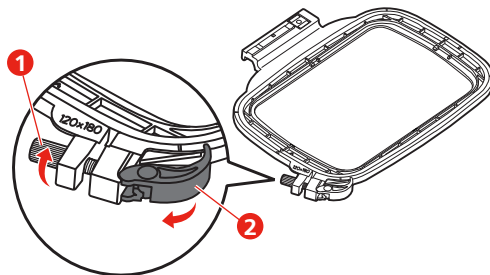
- > Place the stabilizer on the underside of the material.
- > Use adhesive spray to adhere stabilizer if necessary.
- > For material with a pile, reinforce with additional, suitable stabilizer on the wrong side.
- > Place all the layers together into the embroidery hoop.
- > After dissolving, lay the motif down flat and let dry.

### Preparing the embroidery hoop

The embroidery hoop consists of an outer and an inner hoop. There is an embroidery template for each hoop. The area to be embroidered is marked in 1 cm (0,39 in) squares. The center is marked with hole and cross lines. The required marks can be transferred to the material.

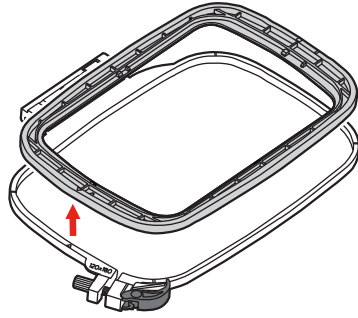


- > Loosen the screw (1) or open the quick release device (2) on the outer hoop.
  - If a new type of fabric is used, the pressure must be adjusted by turning the screw.

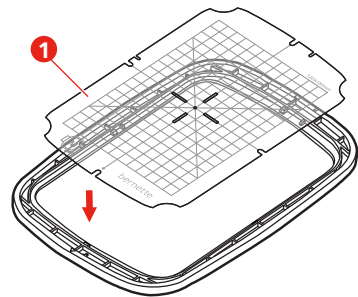




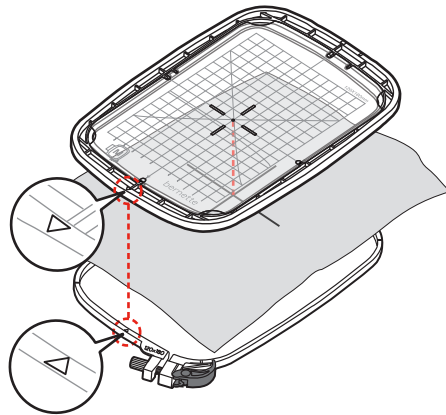
- > Remove the inner hoop.



- > Place the template (1) in the inner hoop, so the bernette logo is at the front edge, and make sure the cut outs click into place.

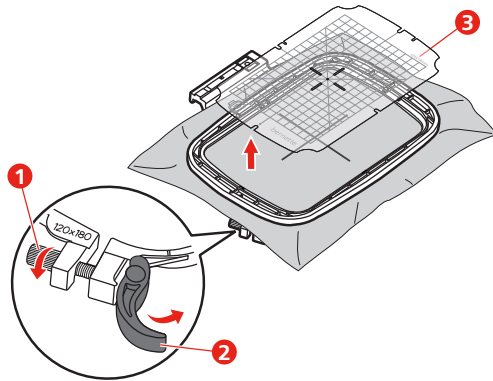


- > Place fabric under the inner frame so that it is at least 2 cm above the hoop.
- > Line up the marked center point on the center of the template.
- > Place the material and the inner hoop on the outer hoop so that the arrows of both hoops match.



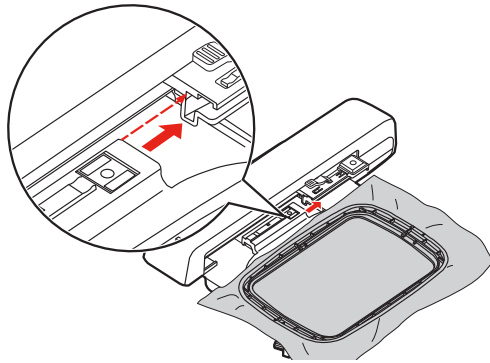
- > Fit the hoops into each other; ensure that the material does not move.
- > Hoop the fabric to be embroidered tightly.
- > Close the quick release device (2). If necessary, tighten screw (1).
- > The inner hoop should protrude about 1 mm on the underside, this prevents the hoop from sticking to the stitch plate.
- > The quick release device (2) is for changing the same type (thickness) fabric easily and quickly.

- > Remove the template (3) from the hoop.

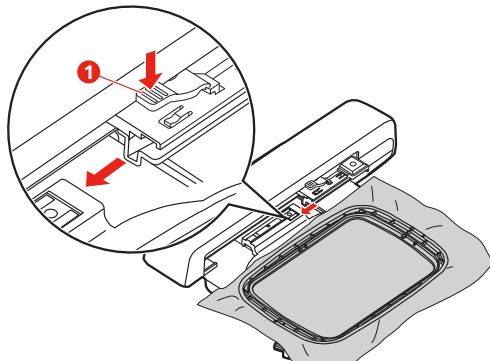


### Attaching the hoop

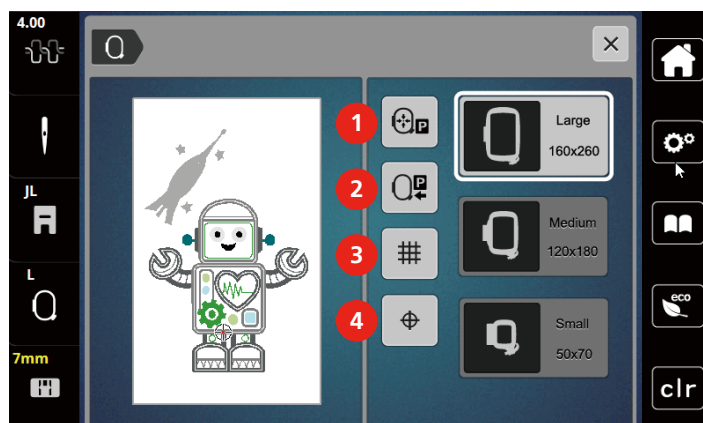
- > Raise the needle.
- > Raise the embroidery foot.
- > Position the embroidery hoop under the embroidery foot.
- > Push the embroidery hoop into the embroidery module until it clicks into place.
  - The hoop is attached.



- > To remove the hoop, press the securing lever and pull the hoop backwards.



## Overview Embroidery functions



- |   |  |   |              |
|---|--|---|--------------|
| 1 | Center the needle to the embroidery hoop | 3 | Grid on/off  |
| 2 | Embroidery arm return                    | 4 | Motif center |

### Locating the center of the embroidery motif

The embroidery hoop is positioned so that the needle is exactly above the center of the embroidery motif or the motif begin.



- > Touch the icon «Embroidery hoop display/Embroidery hoop selection».



- > Touch the icon «Center of the embroidery motif» to position the hoop so that the needle is placed exactly over the center of the embroidery motif.
- > Touch the icon «Center of the embroidery motif» again to position the hoop so that the needle is placed exactly over the motif start.

### Center the needle to the embroidery hoop

Relocating the embroidery hoop facilitates threading when the needle is close to the embroidery hoop.



- > Touch the icon «Embroidery hoop display/Embroidery hoop selection».



- > > Touch the icon «Center the needle to the embroidery hoop» to move the hoop to the center.
- > Thread the upper thread.



- > Push the button «Start/Stop» to move the hoop back to its previous position.

### Embroidery arm return

The embroidery arm can be positioned to store the embroidery module.



- > Touch the icon «Embroidery hoop display/Embroidery hoop selection».
- > Remove the hoop.



- > Touch the icon «Embroidery arm return» the embroidery arm travels horizontally to the left to the park position.



- > Push the button «Start/Stop» to move the embroidery arm to the last position.

### Grid on/off

When the center of the hoop and the grid are displayed, the embroidery motif can be positioned more exactly.



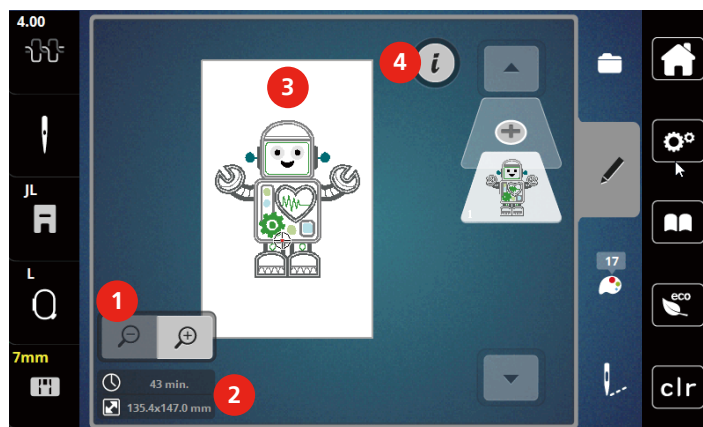
- > Touch the icon «Embroidery hoop display/Embroidery hoop selection».



- > Touch the icon «Grid on/off» to display the center of the hoop on the display.
- > Touch the icon «Grid on/off» again to display the grid.
- > Touch the icon «Grid on/off» again so that the center of the hoop and the grid disappear.

## 14 Creative embroidering

### 14.1 Overview embroidering



- |   |   |   |                        |
|---|---|---|------------------------|
| 1 | Scaling up, downsizing and moving the embroidery motif view | 3 | Area to be embroidered |
| 2 | Embroidery time/Embroidery motif size in mm                 | 4 | «i»-Dialog             |

### 14.2 Selecting and changing the embroidery motif



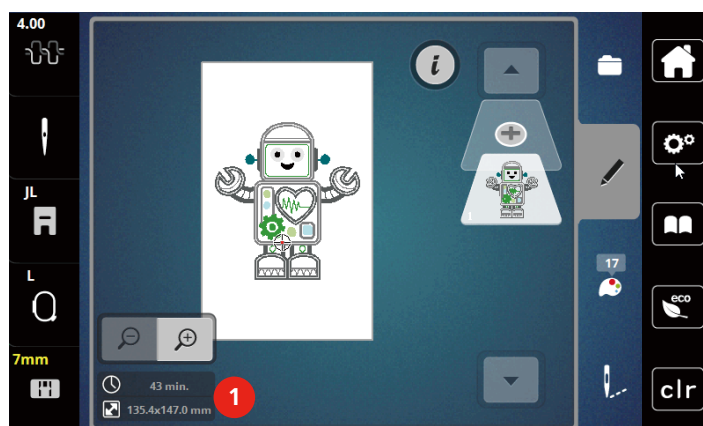
- > Touch the icon «Selection».



- > Touch the icon «Upload embroidery motif».
- > Select a new embroidery motif.

### 14.3 Checking the embroidery time and the embroidery motif size

In the selection menu «Editing» the estimated embroidery time in minutes as well as the width and height of the embroidery motif is indicated at lower left (1).



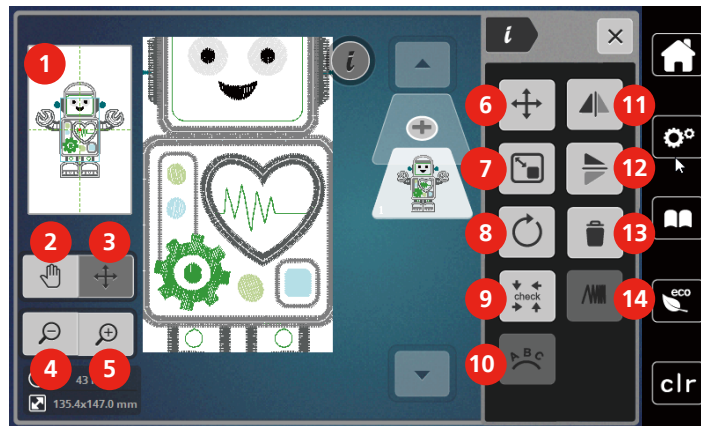
### 14.4 Regulating the speed

The sewing speed can be adjusted infinitely variable with the slide.

- > Move the slide to the left to reduce the sewing speed.
- > Move the slide to the right to increase the sewing speed.

## 14.5 Editing the embroidery motif

### Overview Editing embroidery motif



- |   |                                   |    |                             |
|---|-----------------------------------|----|-----------------------------|
| 1 | Preview all                       | 8  | Rotating motif              |
| 2 | Moving the view                   | 9  | Checking motif size         |
| 3 | Moving the view of the motif      | 10 | Bending the text            |
| 4 | Zoom out                          | 11 | Mirror image left/right     |
| 5 | Zoom in                           | 12 | Mirror image up/down        |
| 6 | Moving the embroidery motif       | 13 | Deleting                    |
| 7 | Altering the motif proportionally | 14 | Altering the stitch density |

### Scaling up the embroidery motif view

The view of the embroidery motif can be scaled up. In addition to that, the view can be adjusted with or without changing the embroidery position.

- > Select an embroidery motif.
- > Touch the icon «Zoom in» to edit the view of the embroidery motif.



- > Touch the icon «Zoom in» 1 to 9 times to enlarge the view of the embroidery motif gradually.



- > Touch the icon «Zoom out» 1 to 9 times to get back to the Edit Mode.



### Downsizing the embroidery motif

The view of the embroidery motif can be downsized. In addition to that, the view can be adjusted with or without changing the embroidery position.

- > Select an embroidery motif.
- > Touch the icon «Zoom in» to scale up the embroidery motif.



- > To downsize the enlarged embroidery motif view by each one step, touch the icon «Zoom out» 1 to 9x.



## Moving the embroidery motif view

The view of the embroidery motif can be moved. In addition to that, the embroidery motif position won't be changed.



- > Select an embroidery motif.
- > Touch the icon «Zoom in» to edit the view of the embroidery motif.



- > Touch the icon «Move the view».
  - The icon turns dark gray.
- > Move the view of the embroidery motif using the touchscreen pen/finger.
  - Touch the icon «Zoom out» again to return to previous view. The embroidery position is not altered.



- > To return to the previous view, touch the icon «Zoom out» again .

## Moving the embroidery motif in enlarged view

The view of the embroidery motif can be moved when the embroidery position is changed.



- > Select an embroidery motif.
- > To activate the icon «Relocating the motif», touch the icon «Zoom in».



- > Touch the icon «Move the motif».
  - The icon turns dark gray.
- > Move the embroidery motif using the touchscreen pen/finger.
  - The embroidery motif position is altered.



- > To return to the previous view, touch the icon «Zoom out» again .

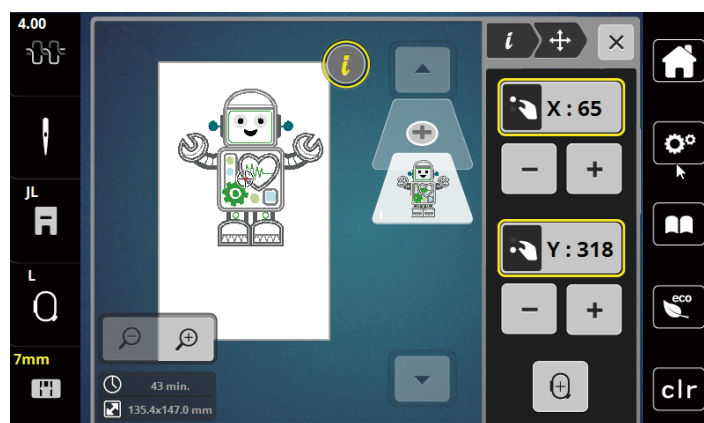
## Moving the embroidery motif



- > Select an embroidery motif.
- > Touch the icon «i»-Dialog.



- > Touch the icon «Move the motif».
- > Turn the Upper Multifunction knob to move the embroidery motif horizontally.
- > Turn the «Lower Multifunction knob» to move the embroidery motif vertically in 0.5-mm steps or touch the «+»/«-» icon or touch the embroidery motif, keep it pressed and move it as you like.
  - The relocation is indicated in the yellow-framed icons.





- > Touch the icon «Center of the embroidery motif».
- The embroidery motif is repositioned in the center of the embroidery hoop.

### Rotating motif



- > Select an embroidery motif.
- > Touch the icon «i»-Dialog.



- > Touch the icon «Rotate the motif».
- > Turn the «Upper Multifunction knob» or the «Lower Multifunction knob» to the right or touch the «+» icon to rotate the embroidery motif clockwise.
- > Turn the «Upper Multifunction knob» or the «Lower Multifunction knob» to the left or touch the «-» icon to rotate the embroidery motif counter-clockwise.



- > Touch the icon «Rotate the motif +90°» to rotate the embroidery motif in 90°-steps.

### Altering the embroidery motif size proportionally

The alteration is limited to +/- 20%.



- > Select an embroidery motif.
- > Touch the icon «i»-Dialog.



- > Touch the icon «Alter the embroidery motif proportionally».
- > To increase the size of the embroidery motif proportionally, turn the «Upper Multifunction knob» or the «Lower Multifunction knob» to the right or touch the icon ««+»».
- > To decrease the size of the embroidery motif proportionally, turn the «Upper Multifunction knob» or the «Lower Multifunction knob» to the left or touch the icon ««-»».

### Mirroring embroidery motifs

Embroidery motifs can be mirror-imaged both vertically and horizontally.



- > Select an embroidery motif.
- > Touch the icon «i»-Dialog.



- > Touch the icon «Mirror image left/right» to mirror the embroidery motif vertically.



- > Touch the icon «Mirror image up/down» to mirror the embroidery motif horizontally.



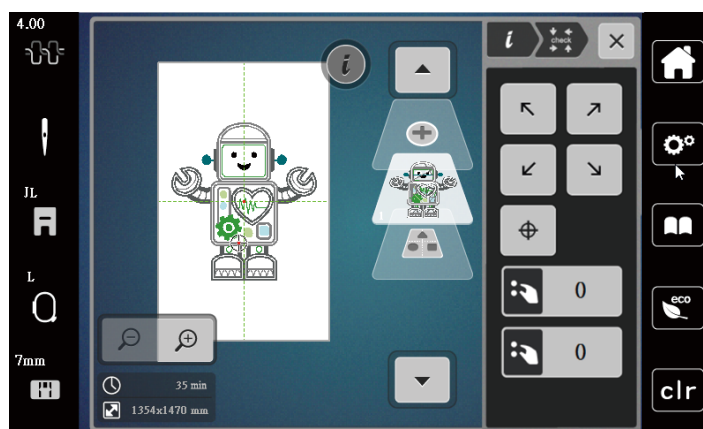
## Checking the size and the position of the embroidery motif

It can be checked whether or not the embroidery motif matches the designated position/location on the fabric.

- > Select an embroidery motif.
- > Touch the icon «i»-Dialog.



- > Touch the icon «Checking the size of the embroidery motif».
  - The embroidery hoop travels all the way until the needle is at the position as it is indicated in the display.
  - If the embroidery motif hasn't been positioned correctly yet, the position can be altered via the «Upper/Lower Multifunction knobs» and the complete embroidery positions can be checked again.



- > Touch the icon «Embroidery motif center» to bring the needle to the center of the embroidery motif.
- > Turn the «Upper Multifunction knob» to move the embroidery motif horizontally.
- > Turn the «Lower Multifunction knob» to move the embroidery motif vertically.

## Deleting an embroidery motif

The active embroidery motif is deleted.

- > Select an embroidery motif.
- > Touch the icon «i»-Dialog.



- > Touch the icon «Delete».



- > Touch the icon «Confirm» to delete the embroidery motif.

## 14.6 Creating lettering

### Overview embroidery alphabets

Embroidery motif	Name
ABC	Swiss Block
A B C	Swiss Block vertical
ABC	Childs Play
A B C	Childs Play vertical
ABC	Victoria
ABC	Anniversary
أ ب ت	Arabic
А Б В	Cyrillic
א ב ג	Hebrew

### Creating words/sentences

Lettering can be positioned within the hoop as you like. When the embroidery motif is positioned outside the area to be embroidered, the hoop is outlined in red on the display. With the hoop selection it can be checked whether or not the embroidery motif can be embroidered in another hoop. When the lettering does not fit in any hoop, two single words can be combined and positioned below each other as the following example will show.



- > Select the file «Alphabets».
- > Select the font.
- > Enter the text «Made to».
- > Touch the icon (1) (standard setting) to use upper case letters.
- > Touch the icon (2) to use lower case letters.
- > Touch the icon (3) to use numbers and mathematic characters.

- > Touch the icon (4) to use special characters.



- > Touch the icon «DEL» to delete single letters of the entered text.



- > Touch the icon «Confirm» to accept the text.



- > Touch the icon «Embroidery hoop display/Embroidery hoop selection».
- > Select the hoop.
- > Touch the icon «Embroidery hoop display/Embroidery hoop selection» again to go back to the Edit Mode.

### Editing words/sentences



- > Touch the icon «i»-Dialog.



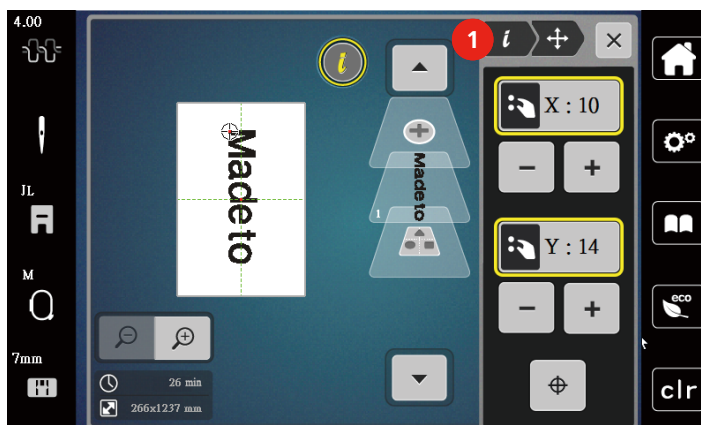
- > Touch the icon «Rotate the motif».



- > Touch the icon «Rotate the motif +90°» to rotate the text by 90°.
- > Touch the icon «i» (1).



- > Touch the icon «Move the motif».
- > Turn the «Upper Multifunction knob» or touch the «+»/«-» icon to move the embroidery motif horizontally.
- > Turn the Lower Multifunction knob or touch the «+»/«-» icon to move the embroidery motif vertically.





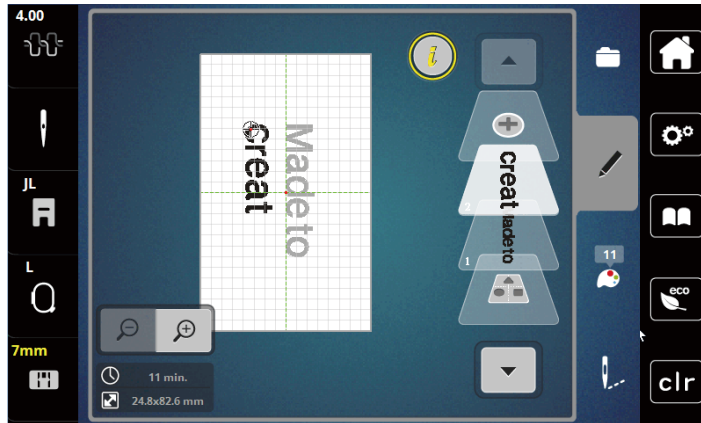
- > Touch the icon «Add motif».
- > Enter and also rotate the text «create».



- > Touch the icon «Embroidery hoop display/Embroidery hoop selection».



- > Touch the icon «Grid on/off» to position the text lines more exactly.



### Bending the text

Texts can be arranged and designed arc-shaped. This function is only applicable to alphabets.

- > Select an alphabet embroidery motif.
- > Touch the icon «i»-Dialog.



- > Touch the icon «Bend text».
- > To alter the distance between the characters in millimeter-steps, turn the «Upper Multifunction knob» or touch the icons «+»/«-».
- > To bend the lettering upwards or downwards, turn the «Lower Multifunction knob» to the left or right or touch the icons «+»/«-».

### Altering the stitch density

- > Select an embroidery motif. This function is only applicable to alphabets.
- > Select an alphabet embroidery motif.
- > Touch the icon «i»-Dialog.



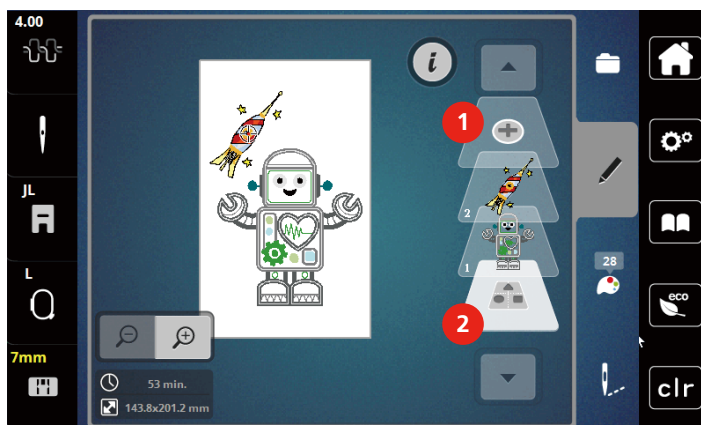
- > Touch the icon «Altering the stitch density».
- > Touch the percentage icon to adjust the desired stitch density.

## 14.7 Combining embroidery motifs

### Combining embroidery motifs



- > Select an embroidery motif.
- > Touch the icon «Add an embroidery motif» (1).
- > Select another embroidery motif.
- > Touch the icon «Select the combination» (2) to select whole embroidery motifs.
  - The size of the combination cannot be adjusted.



1 Loading the embroidery motif

2 Select the combination

### Deleting a single embroidery motif



- > Select the embroidery motif which is to be deleted.
- > Touch the icon «i-Dialog».



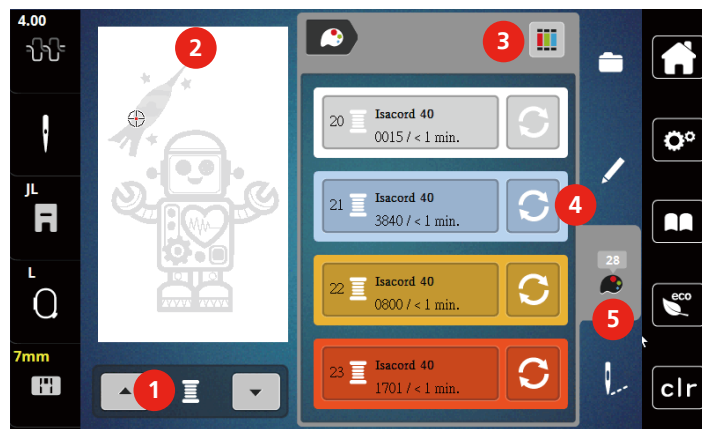
- > Touch the icon «Delete».



- > Touch the icon «Confirm».

## 14.8 Changing the colors of the embroidery motif

### Overview changing the color



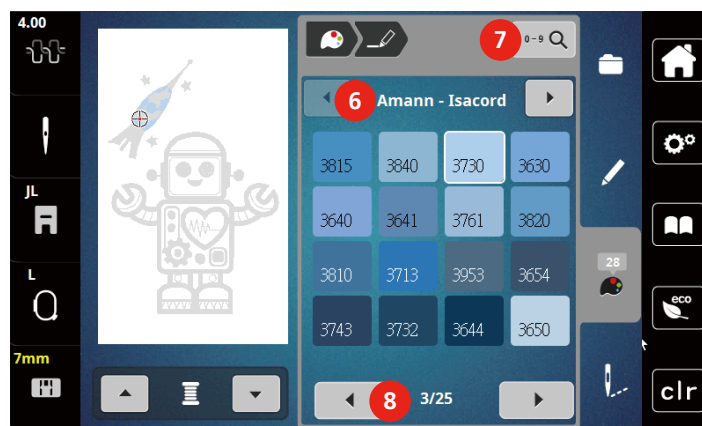
- |   |                                 |   |                   |
|---|---------------------------------|---|-------------------|
| 1 | Colors of the embroidery motifs | 4 | Altering color    |
| 2 | Preview for selected color      | 5 | Color information |
| 3 | Allocating thread brand         |   |                   |

### Changing the colors

- > Select an embroidery motif.
- > Touch the icon «Color information».



- > Touch the icon «Altering color» next to the color which is to be changed.
- > Changing Colors by searching the theme brand.
  - Touch the icon «Scrolling» (6) in the top right portion of the display to display other thread brands.
- > Touch the icon «Color selection by number» (7) to select the color by entering the color number.
- > Touch the icon «Scrolling» (8) in the lower right portion of the display to display other colors.
- > Select the desired color.



### Changing the thread brand



- > Select an embroidery motif.
- > Touch the icon «Color information».



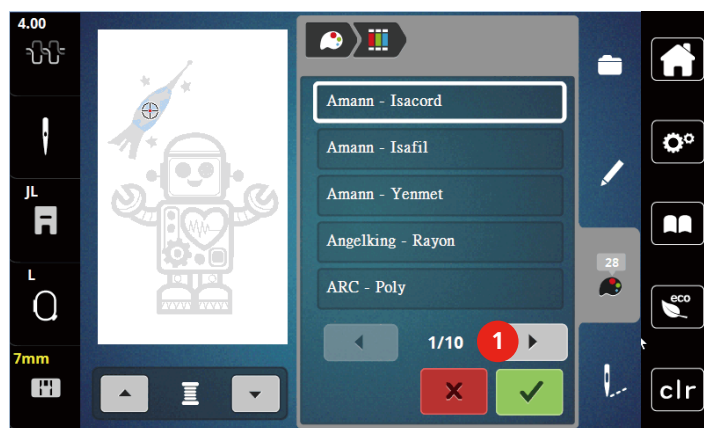
- > Touch the icon «Allocate thread brand».



- > Touch the icon «Scrolling» (1) to have further thread brands displayed.



- > Select a thread brand and touch the icon «Confirm».
- Any thread colors of the selected embroidery motif will be matched with the selected thread brand.



## 14.9 Embroidering the embroidery motif

### Overview Embroidery menu



- |   |                             |   |                                       |
|---|-----------------------------|---|---------------------------------------|
| 1 | Basting                     | 4 | Cutting connecting stitches           |
| 2 | Moving the hoop             | 5 | Multi-colored embroidery motif on/off |
| 3 | Embroidery sequence control | 6 | Color indication                      |

## Adding basting stitches

The basting stitches can be embroidered along the embroidery motif. As a result, the fabric and the stabilizer are better fixed together.



- > Select an embroidery motif.
- > Touch the icon «Embroidering».



- > Touch the icon «Basting» to embroider the basting stitches along the embroidery motif.
- > Touch the icon «Basting» again to deactivate the basting stitches.

## Moving the hoop

If the embroidery project is so big that repeated rehooping is necessary, the embroidered motif can be moved again.



- > Select an embroidery motif.
- > Touch the icon «Embroidering».



- > Touch the icon «Move the hoop».
- > Turn the «Upper Multifunction knob» to move the hoop horizontally.
- > Turn the «Lower Multifunction knob» to move the hoop vertically.

## Embroidery sequence control when thread breaks

If the thread breaks, the needle can be repositioned in the embroidery motif using the Embroidery sequence control function.



- > Select an embroidery motif.
- > Touch the icon «Embroidering».



- > Touch the icon «Embroidery sequence control if thread breaks».
  - A compact view of the embroidery motif appears on the left side of the display. On the right side the embroidery motif is shown in enlarged view.

### – Repositioning via the compact view

- > Select the desired position in the overall view (1) (2) with the touchscreen pen/finger.

### – Repositioning via the stitch bar

- > Select the bar in the display (3) (4) with the touchscreen pen/finger.

### – Repositioning via the multifunction knobs

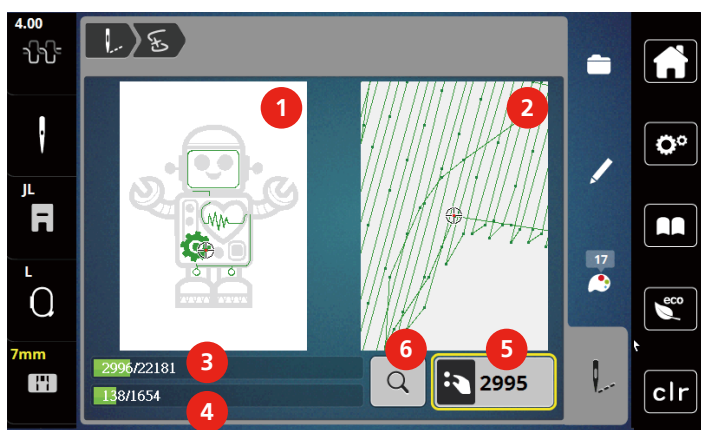
- > To move the embroidery hoop stitch by stitch, turn the «Upper Multifunction knob».
- > To move the embroidery hoop in large steps, turn the «Lower Multifunction knob».

### – Repositioning via the magnifier





- > To select the desired stitch via the entry, touch the «Magnifier» (6).



- The number in the yellow-framed icon (5) indicates the number of stitches of the embroidery process
- > Set the needle position back so that the new start is made a few stitches before the thread has broken.

### Cutting connecting stitches

The function is activated by default and the connecting stitches are cut automatically. When the function is deactivated, the connecting stitches between the embroidery motifs must be cut manually.

- > Select an embroidery motif.
- > Touch the icon «Embroidering».

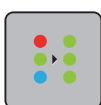


- > Touch the yellow-framed icon «Cut the connecting stitches» to deactivate the function.
- > Touch the icon «Cut the connecting stitches» again to activate the function.

### Multi-colored embroidery motif on/off

Multi-colored embroidery motifs can also be embroidered in one color.

- > Select an embroidery motif.
- > Touch the icon «Embroidering».



- > Touch the icon «Multi-colored embroidery motif on/off».
  - The embroidery motif is embroidered in one color.

### Color indication

Every color of the embroidery motif can be selected individually. The hoop moves to the first stitch of the current color. The currently active color can be embroidered individually or in another sequence.

- > Select an embroidery motif.
- > Touch the icon «Embroidering».



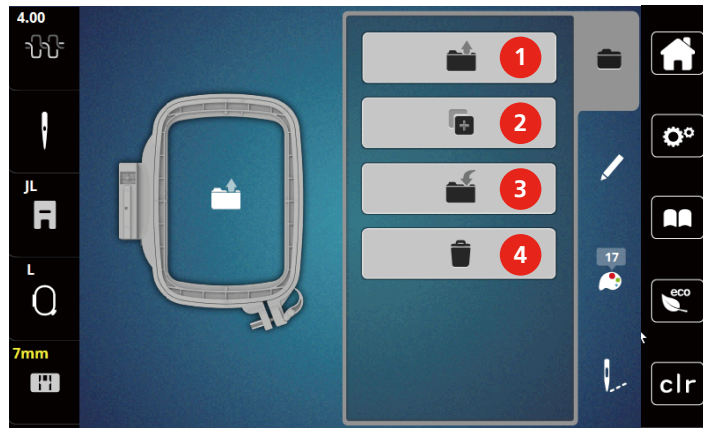
- > Touch the icon «Scroll down» to select the next color of the embroidery motif.



- > Touch the icon «Scroll up» to select the previous color of the embroidery motif.

## 14.10 Administering embroidery motifs

### Administering embroidery motifs



- |   |                              |   |                             |
|---|------------------------------|---|-----------------------------|
| 1 | Loading the embroidery motif | 3 | Saving the embroidery motif |
| 2 | Adding an embroidery motif   | 4 | Deleting                    |

### Saving embroidery motifs in the personal memory

In the filing system «Personal memory» any stitch patterns, also those which have been individually edited, can be saved.

- > Select an embroidery motif.
- > Edit the embroidery motif.
- > Touch the icon «Selection».



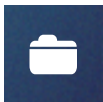
- > Touch the icon «Save the motif».
  - The embroidery motif to be saved is outlined in yellow.
  - The icon «Embroidery machine» is activated.



- > Touch the icon «Confirm».

### Saving the embroidery motif on the USB stick

- > Select an embroidery motif.
- > Edit the embroidery motif.
- > Touch the icon «i»-Dialog.



- > Touch the icon «Save the motif».
  - The embroidery motif to be saved is outlined in yellow.
- > Insert the USB stick into the USB port of the machine.



- > Touch the icon «USB stick».



- > Touch the icon «Confirm».

### Overwriting the embroidery motif in the personal memory

- > Select an embroidery motif.
- > Edit the embroidery motif.
- > Touch the icon «Selection».



- > Touch the icon «Save the motif».
  - The embroidery motif to be saved is outlined in yellow.



- Touch the icon «Embroidery machine» is activated.



- > Select the embroidery motif which is to be overwritten.
- > Touch the icon «Confirm».

### Loading an embroidery motif from the personal memory

- > Touch the icon «Selection».



- > Touch the icon «Upload embroidery motif».



- > Select the file «Personal embroidery motifs».
- > Select an embroidery motif.

### Loading an embroidery motif from the USB stick

- > Touch the icon «i»-Dialog.
- > Insert the USB stick into the USB port of the machine.



- > Touch the icon «USB stick».
- > Select a personal embroidery motif.
- > By clicking on the icon «Display embroidery motif name/embroidery motif image» in the attachment, you can switch between the embroidery motif name and the embroidery motif image. This is only possible when loading a motif from the USB stick.

### Deleting an embroidery motif from the personal memory

The embroidery motifs which are saved in the personal memory can be deleted individually.

- > Touch the icon «i»-Dialog.



- > Touch the icon «Delete».



- Touch the icon «Embroidery machine» is activated.



- > Select the embroidery motif which is to be deleted.
- > Touch the icon «Confirm».

### Deleting an embroidery motif from the USB stick



> Touch the icon «i»-Dialog.



> Touch the icon «Delete».

> Insert the USB stick into the USB port of the machine.



> Touch the icon «USB stick».

> Select the embroidery motif which is to be deleted.



> Touch the icon «Confirm».

## 15 Embroidery

### 15.1 Embroidering via the button «Start/Stop»

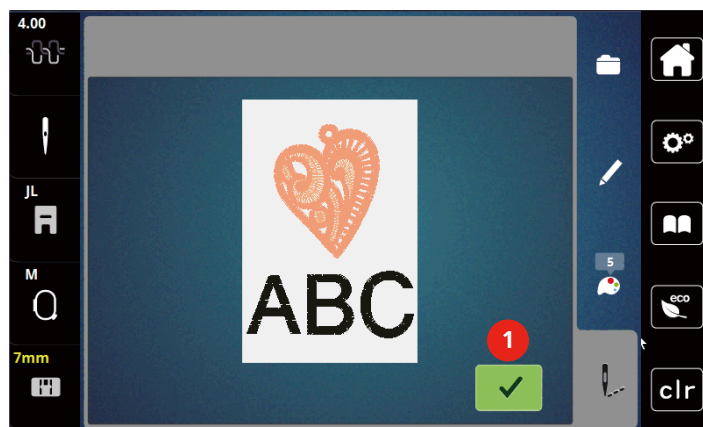
In case of a power cut the embroidery process is interrupted. After the restart the machine goes to the position which was embroidered last.



- > Push the button «Start/Stop» to start the embroidery machine.
  - All parts of the motif being in the current color are embroidered.
  - The embroidery machine stops automatically at the end.
  - Both threads are cut automatically.
  - The embroidery machine switches to the next color automatically.



- > Change the upper thread.
- > Push the button «Start/Stop» to embroider the new color.
  - After having completed the embroidery motif, the machine stops automatically and the threads are cut automatically.
- > Touch the icon «Confirm» to finish the embroidery motif.



### 15.2 Adjusting the upper thread tension

Basic settings are applied automatically when an embroidery motif or program is selected.

When using different types of embroidery threads, the optimal tension may vary. Therefore it may be necessary to adjust the upper thread tension according to the embroidery project as well as the desired embroidery motif individually.

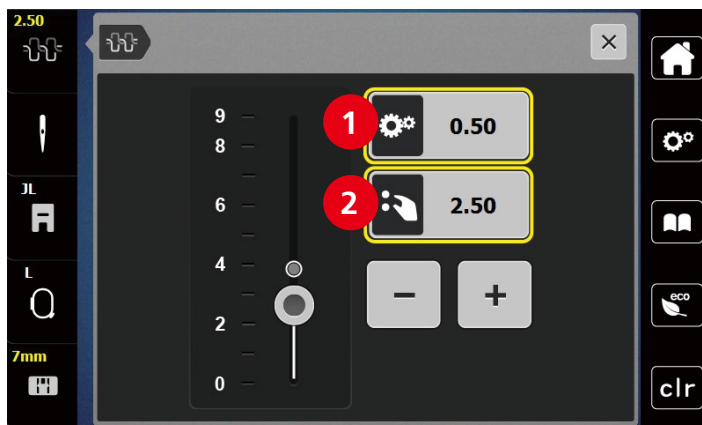
The higher the upper thread tension, the tighter the upper thread which means that the bobbin thread is pulled up to the top of the fabric. When the upper thread tension is low, the upper thread is less tightened which means that the bobbin thread is pulled up less.

Alteration of the upper thread tension affect the currently embroidery motif. Permanent alterations of the upper thread tension can be made in the Setup Program.



- > Touch the icon «Upper thread tension».

- > Move the slider in the display using the touchscreen pen/finger to increase or reduce the upper thread tension.



- 1 Permanent alteration of thread tension
- 2 Thread tension of the current embroidery motif

## 16 BERNINA CutWork Tool

### 16.1 Changing the CutWork Tool



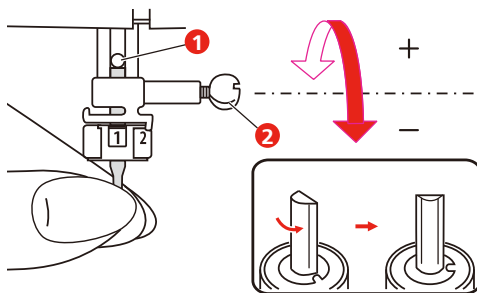
The CutWork Tool accessory is optional. It is not included with this machine.

The CutWork Tool is a very sharp accessory. Special care is required when working with this tool and keep fingers away from the sharp knife. You can find more information in the CutWork book, which is packaged with the CutWork tool.

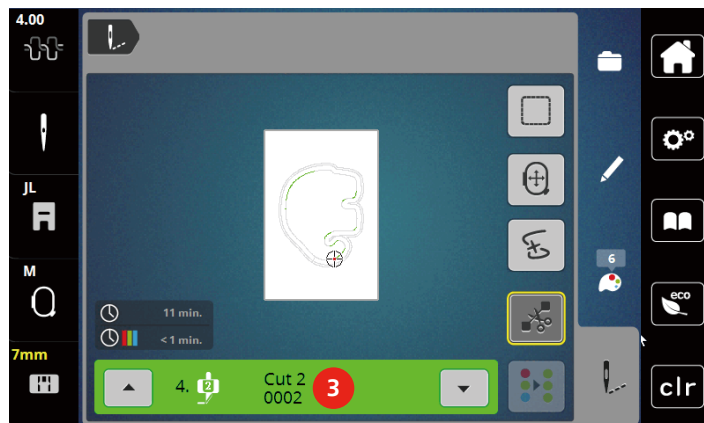
In CutWork Mode the upper thread, bobbin thread and cut thread sensor are disabled.

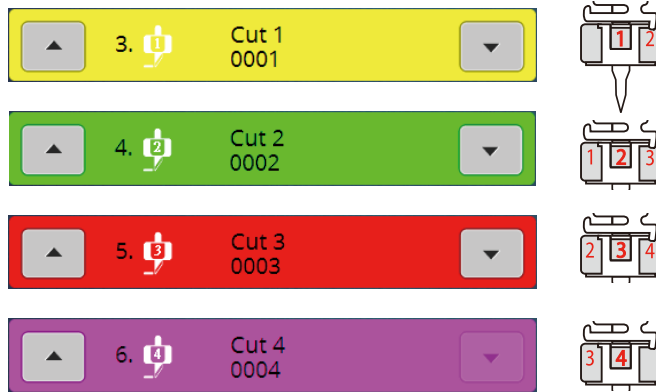
Prerequisite:

- Stitch plate CutWork/Straight ist attached.
- > Remove the embroidery foot.
- > Remove the needle.
- > Insert the CutWork Tool with the flat side back, fully up to the top (1). Tighten the needle clamp screw (2).



- > Attach the embroidery foot.
- > Turn the CutWork Tool according to the information in the display of the color indication (3).





## 16.2 Start to cut



- > Push the button «Start/Stop» and start to cut.
  - When it is completed, the machine stops automatically and return to Embroidery menu display.
- > Turn the CutWork Tool knife according to the cutting position on the display of Color indication (3).
- > Repeat the same actions.
- > When the cutting is completed, the machine stops automatically and shows the embroidery finished screen on the display.



## 17 Appendix

### 17.1 Maintenance and cleaning

#### Cleaning the display

- > Clean the display in the switched off status with a soft slightly damp microfiber cloth.

#### Cleaning the feed dog

Remove the thread remnants under the stitch plate regularly.

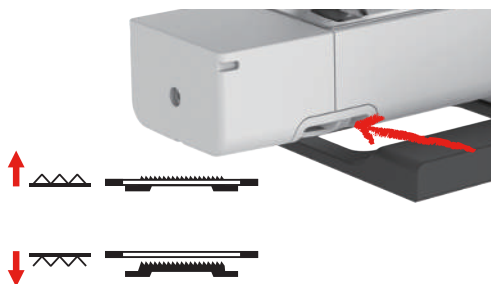


#### Electronically driven components

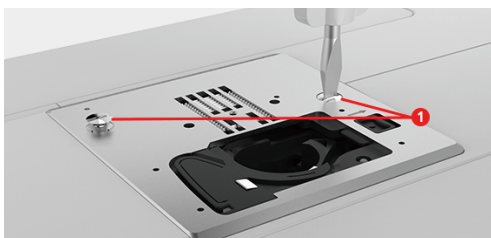
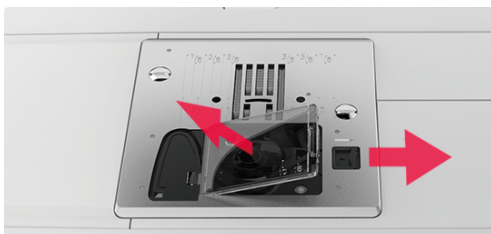
Risk of injury near the needle and the hook.

- > Raise the presser foot.
- > Switch the machine off and disconnect it from the power supply system.

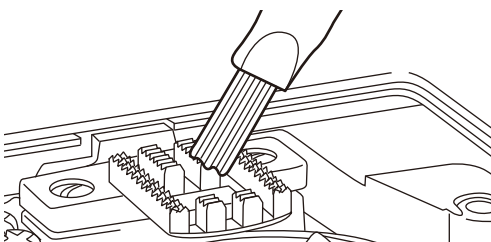
- > Remove the presser foot and the needle.
- > Lower feed dog.



- > Remove the stitch plate.



- > Clean the feed dog with the brush.



## Cleaning the hook



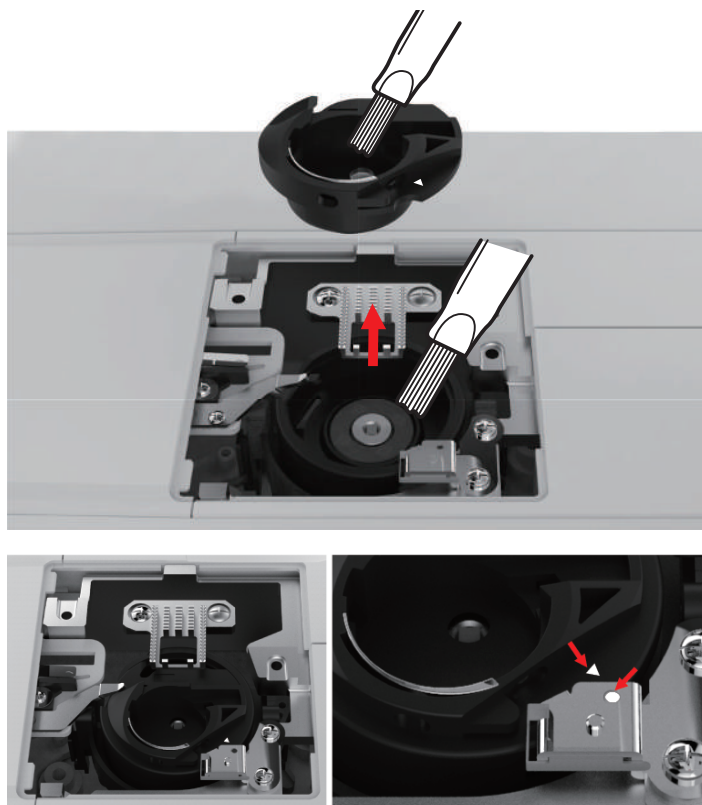
### Electronically driven components

Risk of injury near the needle and the hook.

- > Raise the presser foot.
- > Switch the machine off and disconnect it from the power supply system.

- > Remove the needle and the presser foot.
- > Remove the stitch plate.
- > Clean the bobbin carrier with a brush.

**Please note:** The markings of the bobbin carrier of the stitch plate must be aligned in the same way.



## Oiling the needle bar

The needle bar may not move smoothly without lubrication. If the machine is used frequently, the needle bar should be oiled every 6 months to prevent blocking.

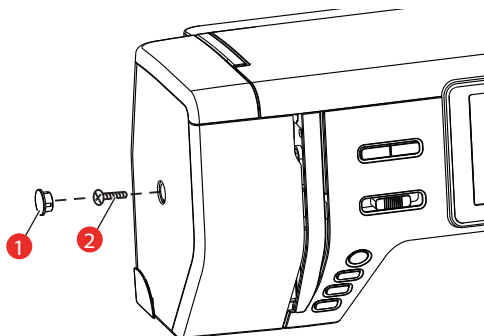


### Electronically driven components

Risk of injury near the needle bar.

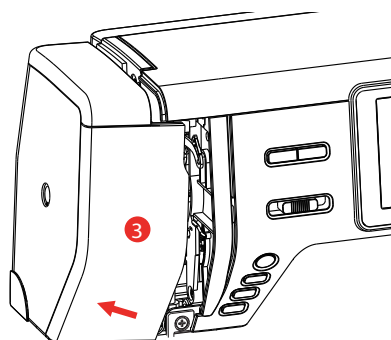
> Switch the machine off and disconnect it from the power supply system.

> Remove the protection cap (1) and the screw (2).



> Remove the head cover (3).

– After removing the head cover, pay attention to the moving parts.



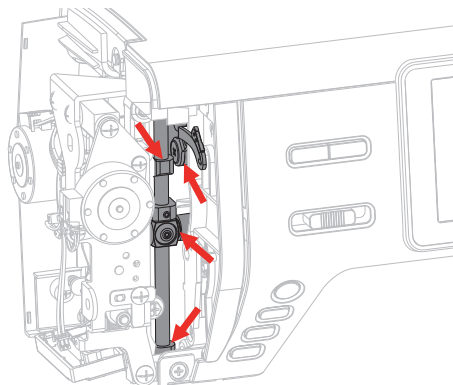
> Apply a drop of oil to the movement mechanism of the needle bar, including the crankshaft/needle bar, needle bar holder and needle bar carrier (apply oil to the areas marked with an arrow).

> Remove the presser foot.

> Turn the handwheel several times and remove excess oil with a cloth.

> After lubricating, the head cover must be fitted before the machine is connected again.

– Never connect or run the machine with the head cover removed.





## 17.2 Troubleshooting

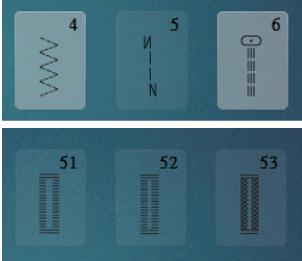
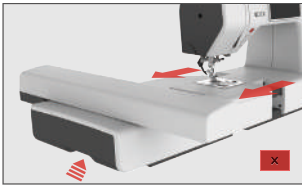
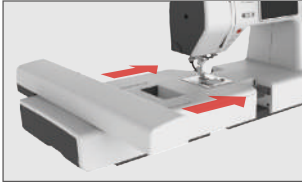

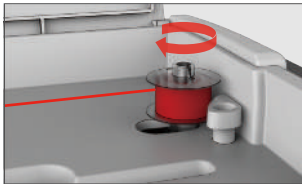
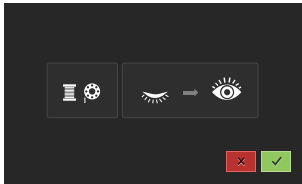
Failure	Cause	Repair
<b>Uneven stitch formation</b>	Upper thread too tight or too loose.	> Adjust upper thread tension.
	Needle blunt or bent.	> Replace the needle, make sure that a new BERNINA quality needle is used.
	Poor quality needle.	> Use a new BERNINA quality needle.
	Poor quality thread.	> Use quality thread.
	Incorrect needle/thread combination.	> Match the needle with the thread size.
	Incorrectly threaded.	> Rethread.
	Fabric has been pulled.	> Feed the fabric evenly.
<b>Skipped stitches</b>	Incorrect needle.	> Use the needle system 130/705H.
	Needle blunt or bent.	> Replace the needle.
	Poor quality needle.	> Use a new BERNINA quality needle.
	The needle is incorrectly inserted.	> Insert the needle with the flat side to the back as far up as it will go into the needle holder and tighten the screw.
	Incorrect needle point.	> Match the needle point to the texture of the material.
<b>Faulty stitching</b>	Thread remnants between the thread tension discs.	> Fold a piece of thin material and slide the folded edge (not the raw edges) between the thread tension discs.
	Incorrectly threaded.	> Rethread.
	Thread is caught in the hook.	> Remove the upper thread and the bobbin case, turn the handwheel backwards and forwards by hand and remove the thread remnants.
	Incorrect needle/thread combination.	> Check the needle/thread combination.

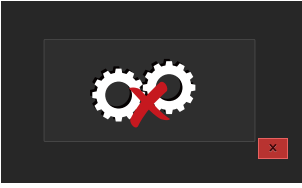
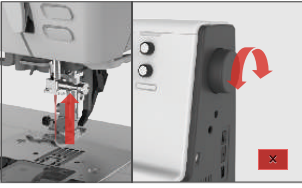


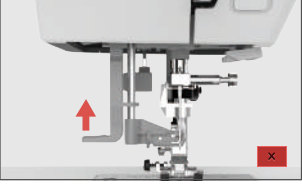

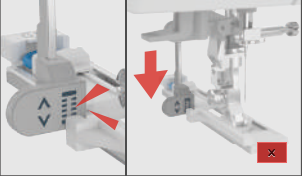
Failure	Cause	Repair
<b>Upper thread breaks</b>	Incorrect needle/thread combination.	> Match the needle with the thread size.
	Upper thread is too tight.	> Reduce the upper thread tension.
	Incorrectly threaded.	> Rethread.
	Poor quality thread.	> Use quality thread.
	The stitch plate or the hook tip is damaged.	> Contact a specialized bernette dealer to have the damages repaired. > Replace the stitch plate.
<b>Lower thread breaks</b>	The bobbin is not inserted correctly.	> Remove and reinsert the bobbin and pull on the thread. – The thread should run easily.
	The bobbin is threaded incorrectly.	> Check bobbin and thread correctly.
	The stitch hole in the stitch plate is damaged.	> Contact a specialized bernette dealer to have the damages repaired. > Replace the stitch plate.
	Needle blunt or bent.	> Replace the needle.
<b>Needle breaks</b>	The needle is incorrectly inserted.	> Insert the needle with the flat side to the back as far up as it will go into the needle holder and tighten the screw.
	Fabric has been pulled.	> Feed the fabric evenly.
	Thick fabric has been pushed.	> Use the appropriate presser foot, e.g. Jeans foot No. 8 for thick material. > Use the height compensating tool when sewing over a thick seam.
	Knotted thread.	> Use quality thread.
<b>Display is inactive</b>	Incorrect calibrating data.	> Switch the machine off. > Switch the machine on and at the same time push button «Needle left/right» and keep it pressed. > Calibrate the display again.
	The eco mode is active.	> Touch the icon «eco» again.
<b>Stitch width not adjustable</b>	The selected needle and stitch plate cannot be used in combination.	> Replace the needle. > Replace the stitch plate.

Failure	Cause	Repair
<b>Speed too low</b>	Unfavorable room temperature.	> Place the machine in a warm room one hour before use.
	Settings in the Setup Program.	> Adjust the sewing/embroidery speed in the Setup Program. > Adjust the slide.
<b>The machine doesn't start</b>	Unfavorable room temperature.	> Place the machine in a warm room one hour before use. > Connect the machine and switch it on.
	The machine is damaged.	> Contact the specialized bernette dealer.
<b>The light of the button «Start-/Stop» doesn't light up</b>	Light is defect.	> Contact the specialized bernette dealer.
<b>Neither the sewing light nor the light on the free arm lights up</b>	Settings in the Setup Program.	> Activate it in the Setup Program.
	The sewing light is defect.	> Contact the specialized bernette dealer.
<b>Upper thread indicator doesn't react</b>	Settings in the Setup Program.	> Activate it in the Setup Program.
	The upper thread indicator is defect.	> Contact the specialized bernette dealer.
<b>Bobbin thread indicator doesn't react</b>	Settings in the Setup Program.	> Activate it in the Setup Program.
	The bobbin thread indicator is defect.	> Contact the specialized bernette dealer.
<b>Error during software update</b>	The update process is blocked and the hourglass on the display is inactive.	> Remove the USB stick. > Switch the machine off. > Rename the firmware file from «.fw» to «.auto». > Insert the USB stick. > Switch the machine on. – The update starts automatically.

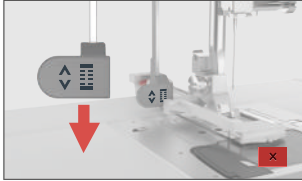
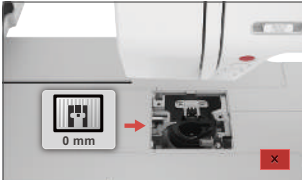
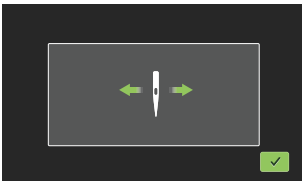
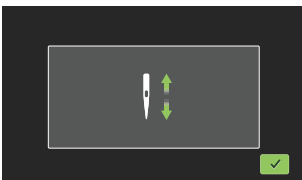

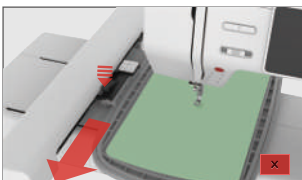

### 17.3 Error messages

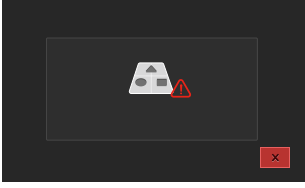
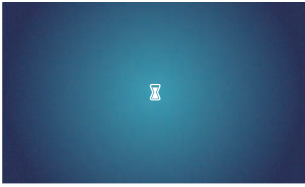
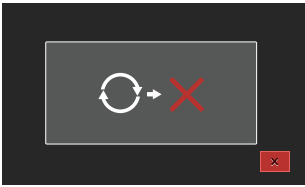

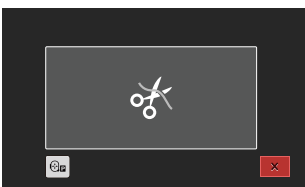

Message on the display	Cause	Repair
	The stitch does not exist.	> Check the entry and enter the new number.
	Selection of the stitch pattern not possible in the Combi mode.	> Check the entry and enter the new number.

Message on the display	Cause	Repair
	The stitch cannot be used in Combi mode.	<ul style="list-style-type: none"> <li>&gt; Select other stitches.</li> </ul>
	Embroidery module has to be removed.	<ul style="list-style-type: none"> <li>&gt; Push the release button and pull the embroidery module carefully to the left.</li> </ul>
	The embroidery module has to be attached.	<ul style="list-style-type: none"> <li>&gt; Carefully slide the module from left to right into the module connection of the machine.</li> </ul>
	The selected needle and stitch plate cannot be used in combination.	<ul style="list-style-type: none"> <li>&gt; Check if the selection of needle and stitch plate is correct.</li> <li>&gt; Change the needle and select the correct needle in the User Interface.</li> <li>&gt; Change the stitch plate and select the correct stitch plate in the User Interface.</li> </ul>
	The bobbin winder is activated.	<ul style="list-style-type: none"> <li>&gt; Deactivate the bobbin winder.</li> </ul>
	The thread indicator is deactivated.	<ul style="list-style-type: none"> <li>&gt; To activate both indicators, touch the icon «Confirm».</li> <li>&gt; To keep the indicators deactivated, touch the icon «Cancel».</li> </ul>

Message on the display	Cause	Repair
 	The main motor isn't running.	<ul style="list-style-type: none"> <li>&gt; Turn the handwheel clockwise until the needle is at its top position.</li> <li>&gt; Remove the stitch plate.</li> <li>&gt; Remove the thread remnants.</li> <li>&gt; Clean the hook.</li> <li>&gt; Remove the hook and make sure that there are no pieces of broken needle points on the magnetic back of the hook.</li> </ul>
	The upper thread is used up.	<ul style="list-style-type: none"> <li>&gt; Insert a new spool.</li> <li>&gt; Rethread.</li> </ul>
	The upper thread has broken.	<ul style="list-style-type: none"> <li>&gt; Rethread.</li> </ul>
	The bobbin thread is used up.	<ul style="list-style-type: none"> <li>&gt; Remove the empty bobbin, fill it on the winder unit and thread.</li> </ul>
	The needle threader lever is not raised.	<ul style="list-style-type: none"> <li>&gt; Raise the needle threader lever.</li> </ul>
	The bernette USB stick (Optional accessory) is not inserted	<ul style="list-style-type: none"> <li>&gt; Insert the bernette USB stick (Optional accessory) into the USB stick socket.</li> </ul>
	Not enough free space available on the USB stick (Optional accessory).	<ul style="list-style-type: none"> <li>&gt; Delete the data on the USB stick (optional accessory).</li> <li>&gt; Overwrite the data on the USB stick.</li> </ul>
	The buttonhole lever doesn't touch the buttonhole foot with slide (RJ).	<ul style="list-style-type: none"> <li>&gt; Pull down the buttonhole lever as far as possible until it clicks into place.</li> </ul>



Message on the display	Cause	Repair
	Buttonhole lever is not lowered.	> Pull down the buttonhole lever as far as possible until it clicks into place.
	Wrong stitch plate is used.	> Remove the stitch plate and insert the correct one.
	Needle moves sideways.	When the stitch plate is being changed, this picture appears because the needle is likely to move.
	The needle moves upwards.	> Check that there are no other objects near the needle plate. > Touch the icon «Confirm» to raise the needle.
	The hoop is not attached.	> Attach the hoop.
	The hoop is attached.	> Remove the hoop.
	The embroidery hoop is calibrated.	> Touch the icon «Confirm».

Message on the display	Cause	Repair
	The maximum number of stitches, which is 120.000, has been reached.	> Select another pattern with less stitches.
	The data is loading.	> Wait for processing.
	Software version update failed.	> Check the update file on the USB stick. > Touch the icon «Cancel» and try to start the update again.
	The embroidery motif is partly outside the hoop or too big for the hoop.	> Reduce the size of the embroidery motif. > Re-position the embroidery motif. > Attach a bigger hoop.
	This message appears after activating the thread cutter when embroidering has been started.	> Cut the thread manually.
	This message is displayed after switching sewing mode to the embroidery mode.	> Do not lower the dual feed.

## 17.4 Storage and disposal

### Storing the machine

It is recommended to store the machine in the original packaging. If the machine is stored in a cold room, place it in a warm room one hour before use.

- > Switch the machine off and disconnect it from the power supply system.
- > Don't store the machine outdoor.
- > Protect the machine against climatic influences.

### Dispose of the machine

- > Clean the machine.
- > Sort the components by their materials and dispose of them according to the local laws and regulations.


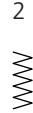






















## 17.5 Technical data

Term	Value	Measurement unit
Sewing light	300, 2	mA, Watt
Maximum speed	Sewing mode: 1000 Embroidery mode: 850	Stitches per minute
Measurements (B × T × H)	509 × 199,8 × 314,3	mm
Weight	10	kg
Energy consumption	100	W
Input voltage	100 – 240	V
Protection class (Electrical engineering)	Class II	


















## 18 Overview stitch patterns

### 18.1 Overview Stitch patterns

#### Practical stitches

























1 	2 	3 	4 	5 	6 	7 	8 	9 	10 	11 
12 	13 	14 	15 	16 	17 	18 	19 	20 	21 	22 
23 	24 									

#### Buttonholes









51 	52 	53 	54 	55 	56 	57 	58 	59 	60 	61 
62 	63 	64 	66 	69 	71 					

#### Decorative stitches






















##### Satin stitches

101 	102 	103 	104 	105 	106 	107 	108 	109 	110 	111 
112 	113 	114 	115 	116 	117 	118 	119 	120 	121 	122 
123 	124 									


































































Cross stitches

125	126	127	128	129	130	131	132			
										

Floral stitches

133	134	135	136	137	138	139	140	141	142	143
										
144	145	146	147	148	149	150	151	152	153	
										

Ornamental stitches

154	155	156	157	158	159	160	161	162	163	164
										
165	166	167	168	169	170	171	172	173	174	175
										
176	177	178	179	180	181	182	183	184	185	186
										
187	188	189	190	191	192	193	194	195	196	197
										
198	199	200	201	202	203	204	205	206	207	208
										
209	210	211	212	213	214	215	216	217	218	
										

Novelty

219	220	221	222	223	224	225	226	227	228	229
230	231	232	233							

Quilt stitches





1001	1002	1003	1004	1005	1006	1007	1008	1009	1010	1011
1012	1013	1014	1015	1016	1017	1018	1019	1020	1021	1022
1023	1024	1025	1026	1027	1028	1029	1030	1031	1032	1033
1034	1035									

## 18.2 Overview Embroidery motifs











### Editing the embroidery motif







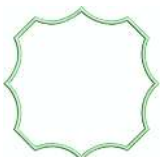










Let your inspiration run free. A vast selection of embroidery motifs is at your disposal.

If you see one of the following pictograms below a number of the embroidery motif, you can find additional information at [www.mybernette.com/7series](http://www.mybernette.com/7series).



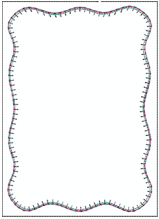



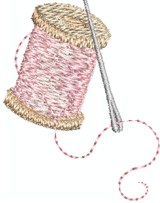
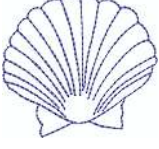
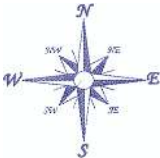
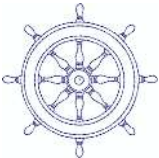

	Detached point		Appliqué
	Fringe embroidery		CutWork Design (motif)

### Embellishment



No.	Embroidery motif Colors	Width x Height in mm	No.	Embroidery motif Colors	Width x Height in mm
1 (002_bell)		50,4 103,0	2 (019_swiss)		150,4 129,4
3 (Edelweiss)		102,9 58,5	4 (12383-18)		90,6 171,2
5 (12490-03)		118 113,4	6 (12490-04)		146,4 122,4
7 (12490-05_sized)		118 97,8	8 (12535-03_1_sized)		155 116
9 (12490-5_sized)		49 100	10 (12587-57)		57,6 20,3

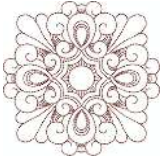



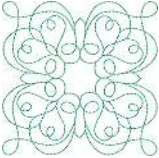






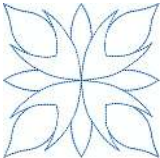

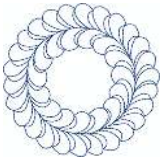

No.	Embroidery motif Colors	Width x Height in mm	No.	Embroidery motif Colors	Width x Height in mm
11 (12587-58)		52,8 116,2	12 (12587-59)		33 94.8
13 (12587-60)		126,2 126	14 (12606-33) 		43 70
15 (12611-27) 		136,9 137,3	16 (12611-28) 		140 140
17 (12670-03)		121 144,6	18 (12669-03)		109,4 194,6
19 (19999-002 _check_S)		125 136,4	20 (21013-29)		152 40.2
21 (21013-30)		75,8 75,8	22 (21021-04)		123 150,2
23 (21021-05)		118,8 155,6	24 (21027-01_ S)		123 122,2



















No.	Embroidery motif Colors	Width x Height in mm	No.	Embroidery motif Colors	Width x Height in mm
25 (21027-14)		120,8 120,8	26 (32078-02) 		123,4 172,9
27 (BE790308_bernette) 		155,2 178,2	28 (FB148_48)		101 89,6
29 (FB158_48)		39,6 53,2	30 (NA597)		56,6 52,8
31 (NA614)		102 101,4	32 (NA617)		96,6 96,6
33 (NB843_48)		87,6 121,2			



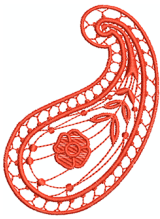
**Quilt motifs**

No.	Embroidery motif Colors	Width x Height in mm	No.	Embroidery motif Colors	Width x Height in mm
1 (12380-04)		83 89,8	2 (12380-22)		110,6 60,8



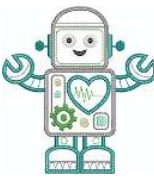










No.	Embroidery motif Colors	Width x Height in mm	No.	Embroidery motif Colors	Width x Height in mm
3 (12380-43)		123,6 123,6	4 (12383-09) 		113,0 77,2
5 (12607-20)		122,4 122,4	6 (BD298_L_b ernette)		155 154,6
7 (BD502_48)		61,4 60,8	8 (BD513_48)		63,4 63,4
9 (BD796_48)		47,2 172,7	10 (BD800_48)		126,1 122,3
11 (BD837_48)		123,6 123,6	12 (NB934_48)		132,4 164,8
13 (Quilt 02)		101,8 101,6	14 (Quilt 09)		139,6 139,6
15 (Quilt 10)		139,6 139,6	16 (Quilt 11)		139,6 139,6









### Borders and Lace

No.	Embroidery motif Colors	Width x Height in mm	No.	Embroidery motif Colors	Width x Height in mm
1 (12398-29) 		26,4 153	2 (12410-08) 		80,6 168,2
3 (12594-03) 		36,4 152	4 (12659-01) 		45,2 57,8
5 (BC015105)		118,4 123	6 (BC01506)		103 131,8
7 (BD567_48)		108 108,2	8 (BE790504)		121,4 121,4
9 (BE790702)		73 190,5	10 (BE790704)		72,5 217,7
11 (BE790705)		42,3 169,3	12 (FQ736_48)		7,9 253,2






No.	Embroidery motif Colors	Width x Height in mm	No.	Embroidery motif Colors	Width x Height in mm
13 (NY)		67 151,6	14 (NX952)		65,6 98,6
15 (NX238)		71,1 97,9			
















### Children








No.	Embroidery motif Colors	Width x Height in mm	No.	Embroidery motif Colors	Width x Height in mm
1 (12401-17)		98,8 55,2	2 (12590-03) 		135,5 147
3 (BE790306)		132,2 151,4	4 (BE790307) 		141,5 126,9
5 (BE790313) 		99 102,4	6 (CM193_48) 		106,6 127,4
7 (CM368_48) )		70,2 140	8 (CM376_48) 		100,4 97,6

No.	Embroidery motif Colors	Width x Height in mm	No.	Embroidery motif Colors	Width x Height in mm
9 (NA667)		83,8 83,8	10 (NB302-48)		68,2 80,6
11 (CK229)		88,8 98	12 (CM428_48)		78,2 106,4
13 (MS974)		94,2 98,6	14 (NZ612)		96 99,6
15 (NZ613)		103 84,1	16 (NZ611)		99,6 81,2





**Flowers**


















No.	Embroidery motif Colors	Width x Height in mm	No.	Embroidery motif Colors	Width x Height in mm
1 (12392-01) 		112,6 157,4	2 (12392-13)		112,6 203,4
3 (21008-24)		97,6 121,6	4 (BE790406)		120,0 180,8

No.	Embroidery motif Colors	Width x Height in mm	No.	Embroidery motif Colors	Width x Height in mm
5 (21012-04) 		123,2 124	6 (80001-23)		85 101,6
7 (BE790304_ sized)		115,2 59,6	8 (BE790401_ bernette)		155,1 220,9
9 (BE790402_ sized)		135,6 259	10 (BE790404_ bernette)		157 180,2
11 (FI135)		88,6 87,1	12 (FI136)		84,7 89,2
13 (FQ527_48)		90,4 141,4	14 (FQ562_48)		90,4 156,4
15 (FQ808_48)		123,8 142,4	16 (FQ810_48)		23,6 206,4
17 (NA146)		63,2 69,3	18 (NB039_48)		97 127





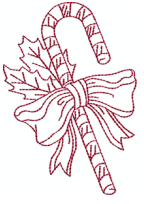
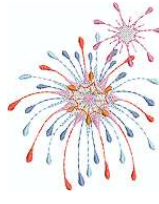

No.	Embroidery motif Colors	Width x Height in mm	No.	Embroidery motif Colors	Width x Height in mm
19 (Rose_S)		63,9 129,2	20 (Sunflower)		91 88,2
21 (FP005)		80,8 95,2	22 (FM856)		76,2 68,2
23 (FQ681_48)		107 138,8	24 (FP238_S)		61,2 65,4
25 (FQ239_48)		62,6 90,4			

### Seasons





No.	Embroidery motif Colors	Width x Height in mm	No.	Embroidery motif Colors	Width x Height in mm
1 (12384-02)		132,8 203,4	2 (12384-11)		84,4 189,8
3 (12400-03)		123,4 161,3	4 (12400-11)		74,2 211,9

No.	Embroidery motif Colors	Width x Height in mm	No.	Embroidery motif Colors	Width x Height in mm
5 (12427-01)		133,8 167,6	6 (12427-11)		81,6 126,2
7 (12443-03)		120,4 161,4	8 (12443-11)		73,4 193,1
9 (BE790301_ sized)		116,2 81,4	10 (BE790303)		69,6 70,2
11 (NA006)		72,4 91,8	12 (HG747_48 ) 		124 147,4
13 (12421-03)		45,8 48,4	14 (12421-11)		39,9 43,6
15 (12421-37)		67,4 61	16 (FQ749_48)		77,6 94,8
17 (HE252) 		88,1 144,9	18 (HE255) 		133,2 127,2

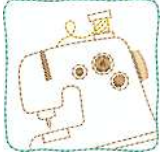























No.	Embroidery motif Colors	Width x Height in mm	No.	Embroidery motif Colors	Width x Height in mm
19 (HE563)		63,2 129,4	20 (HE919_48)		89,2 69,2
21 (HG053_48 )		122 121,8	22 (HG795_48 )		89,2 164,4
23 (HD382)		66 97,4	24 (HD246)		80,8 99
25 (HE179)		89 95,2			

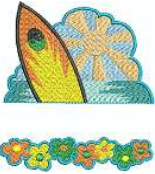

**Asia**

No.	Embroidery motif Colors	Width x Height in mm	No.	Embroidery motif Colors	Width x Height in mm
1 (FB276_48_ sized)		115,1 103,2	2 (FB283_48)		102,4 109,4
3 (FQ194_48)		120,2 118,4	4 (NB124_48 _sized 100%)		155 118,6














### Sport/Hobby















No.	Embroidery motif Colors	Width x Height in mm	No.	Embroidery motif Colors	Width x Height in mm
1 (12465-33)		80 79,8	2 (NX688)		92,2 85,6
3 (12611-08) 		80 119,7	4 (12611-21) 		71,7 155,8
5 (12611-22) 		71,7 155,8	6 (12611-23) 		71,7 155,8
7 (12677-01_ sized) 		117,2 115,2	8 (12677-02) 		116,4 115
9 (12677-03_ sized) 		117 82,4	10 (80085-25) 		134,8 166,2
11 (BE790601_ S)		80,3 80,2	12 (BE790602)		80,2 75,6
13 (BE790603)		80,4 74,8	14 (BE790604)		79,8 80,4












No.	Embroidery motif Colors	Width x Height in mm	No.	Embroidery motif Colors	Width x Height in mm
15 (BE790604)		79,6 79,6	16 (BE790606_ S)		100,2 86
17 (BE790607)		79,8 74,4	18 (BE790608)		80,4 80
19 (SP980)		63,3 63,6	20 (SP989)		101,6 82,4
21 (CK510)		76,2 60	22 (CK522)		70,8 53,2
23 (CK970)		84,8 81,6	24 (LT749)		99,2 38,4
25 (LT920)		89,1 55,6	26 (CM442_48 )		46,4 47
27 (LT870)		97,6 57	28 (NB759)		98,8 61,6
29 (RC675_S)		101,6 79,6	30 (RC675_48)		100,4 99

No.	Embroidery motif Colors	Width x Height in mm	No.	Embroidery motif Colors	Width x Height in mm
31 (SR067)		87,6 96,8	32 (SR589)		95,2 66,6

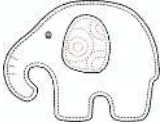



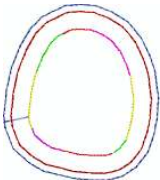

### Animals



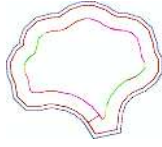
No.	Embroidery motif Colors	Width x Height in mm	No.	Embroidery motif Colors	Width x Height in mm
1 (BE790302 )		68,4 66,4	2 (12672-02 )		138 133,4
3 (CM022_4 8)		89,2 97	4 (CM142_4 8)		56,6 66,8
5 (CM211_4 8)		80,6 70,6	6 (CM213_4 8)		58,2 102
7 (CM220_4 8) 		71,4 71,8	8 (CM226_4 8) 		63,2 63
9 (CM286_4 8)		97,8 82,4	10 (CM362_4 8_sized) 		115,1 107,8

No.	Embroidery motif Colors	Width x Height in mm	No.	Embroidery motif Colors	Width x Height in mm
11 (CM384_4 8)		77,4 80,6	12 (CM465_4 8_sized)		48,2 33
13 (DEC104)		10,4 13	14 (FQ617_ 48)		118 198,2
15 (FQ624_48 )		64,5 144,2	16 (FQ945_48 _S)		93,8 95
17 (LJ699)		93,2 98	18 (WM785)		84,6 103,4
19 (WP201_4 8)		76,2 92	20 (WP325_4 8)		77,8 94
21 (WP217_4 8)		93,8 78,2	22 (WP224_4 8)		100,4 111
23 (WP415_4 8)		132,4 148,4	24 (WP421_4 8)		95,8 137,6



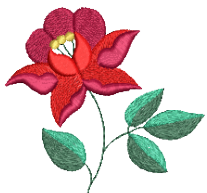
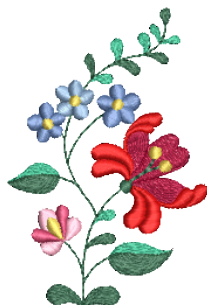
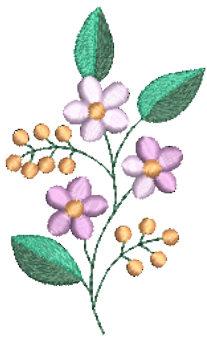
No.	Embroidery motif Colors	Width x Height in mm	No.	Embroidery motif Colors	Width x Height in mm
25 (WS610_4 8_sized)		120 104,4	26 (CM442H D26748)		65,2 51,4
27 (WM784)		106 114,4	28 (BE790305 ) 		118,2 145,6
29 (BE790309 ) 		87,5 149,8	30 (BE790311 ) 		114,1 152,5
31 (BE790312 ) 		122 133			

### Cutwork

No.	Embroidery motif Colors	Width x Height in mm	No.	Embroidery motif Colors	Width x Height in mm
1 (CM594_4 8)		96 75,6	2 (CM594_4 8_CWA01) 		90,8 110,0
3 (CM594_4 8_CWA02) 		43,6 50,2	4 (FS344_ 48)		94,4 101

No.	Embroidery motif Colors	Width x Height in mm	No.	Embroidery motif Colors	Width x Height in mm
5 (FS345_48)		92,6 104,9	6 (FS345_48_CWA) 		80,6 72,2

**Campaign**

No.	Embroidery motif Colors	Width x Height in mm	No.	Embroidery motif Colors	Width x Height in mm
1 (Campaign_3_elements)		118,9 216,7	2 (Campaign_1_element)		75,3 69,3
3 (FB060)		75,7 72,9	4 (FB062)		60 91
5 (FB069)		53,1 87,4			

## Index

### Symbols

---

Remove the presser foot sole 28

### A

---

Activating the bobbin thread indicator 48  
 Activating the upper thread indicator 48  
 Adjusting the brightness of the display 49  
 Adjusting the display color 48  
 Adjusting the presser foot pressure 30  
 Adjusting the presser position via the knee lifter 28  
 Adjusting the sewing light 49  
 Adjusting the upper thread tension 41  
 Alphabet 82  
 Altering the stitch density 122  
 Attaching the FHS knee lifter 23  
 Attaching the hoop 112  
 Attaching the presser foot sole 29  
 Attaching the stitch plate 106

### B

---

Back to default settings 50  
 Buttonholes 84

### C

---

Calibrating the display 49  
 Calibrating the hoop 46  
 Calling up the Creative Consultant 52  
 Calling up the Tutorial 52  
 Changing the needle 30  
 Changing the stitch plate 32  
 Checking the firmware version 51  
 Cleaning the feed dog 135  
 Cleaning the hook 136  
 Combi mode 60  
 Combining embroidery motifs 123  
 Connecting the embroidery module 104

### D

---

Deactivating securing stitches 46  
 Decorative stitches 80  
 Dispose of the machine 145

Dual Feed (DF) 56

### E

---

Embroidery module 98  
 Embroidery test 101  
 Environmental Protection 7  
 Error messages 140  
 Explanation of symbols 7

### F

---

Fabric thickness measurement 45

### H

---

Having the presser foot soles displayed in the user interface 29

### I

---

Inserting the edge/ quilting guide 29  
 Inserting the embroidery needle 106  
 Inserting thread spool 26

### M

---

Maintenance and cleaning 135

### N

---

Needle stop up/down (permanent) 31  
 Needle, Thread, Fabric 19  
 Needle/thread combination 22

### O

---

Overview Embroidery motifs 149  
 Overview Stitch patterns 146

### P

---

Positioning the spool disc 25  
 Practical stitches 67  
 Programming the securing stitches 41

### Q

---

Quick reverse 44  
 Quilting 91

### R

---

Raising or Lowering the Feed dog 27



Raising/Lowering the needle	25
Regulating the speed	57, 115
Removing and inserting the presser foot holder	29

## S

---

Safety instructions	5
Saving a stitch pattern combination	64
Second spool pin	26
Selecting a language	51
Selecting a stitch pattern	55
Selecting an embroidery motif	107
Selecting the stitch plate in the user interface	32
Sound on/off	49
Stitch Designer	94
Storing the machine	145

## T

---

Technical data	145
Threading preparation	33
Threading the bobbin thread	39
Threading the double needle	37
Threading the upper thread	33
Troubleshooting	138

## U

---

Updating the machine Firmware	50
Using a spool net	25
Using eco mode	52

## W

---

Winding the bobbin thread	38
---------------------------	----



[www.mybernette.com/b79](http://www.mybernette.com/b79)

© BERNINA International AG  
Steckborn CH, [www.bernina.com](http://www.bernina.com)