

Let's Get Rolling!

A guide to using Quilter's Creative Touch Edge-to-Edge on a rolling frame

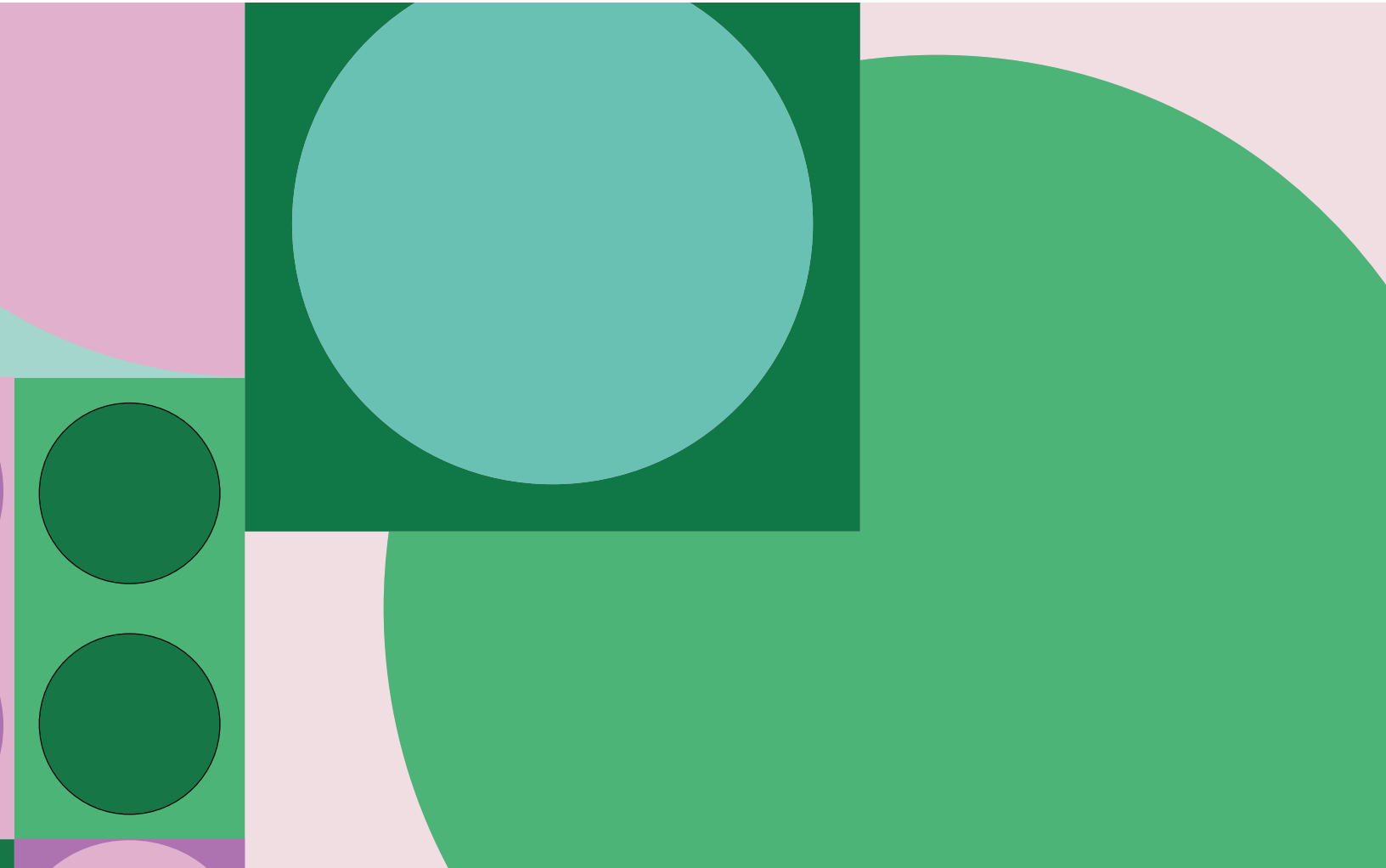

TABLE OF CONTENTS

Introduction to Automated Quilting.....	4	Lesson Ten: Setting the Quilt-Top Edges.....	36
Using the Panel.....	5	Lesson Eleven: Marking Your Placements.....	40
What You'll Need.....	5	Lesson Twelve: Pulling the Bobbin (start).....	44
Lesson One: Getting Ready to Quilt.....	6	Lesson Thirteen: Edge-to-Edge Quilting.....	46
Lesson Two: Tacking Down Your Edges	8	Lesson Fourteen: Pulling the Bobbin (end).....	50
Lesson Three: Opening the Software.....	15	Lesson Fifteen: Marking Your Next Row	51
Lesson Four: Navigating the Software	19	Lesson Sixteen: Placing Your Next Row.....	53
Lesson Five: Setting the Safe Area	21	Lesson Seventeen: Shifting Your Fabric	55
Lesson Six: Selecting a Design.....	24	Lesson Eighteen: Repairing Your Design.....	58
Lesson Seven: Setting Your Design Height	26	Lesson Nineteen: Taking a Break	63
Lesson Eight: Adjusting Your Row Spacing.....	30	Conclusion	64
Lesson Nine: Selecting the Quilt-Top Edges.....	34		

WELCOME TO THE EXCITING WORLD OF AUTOMATED HOME-BASED QUILTING!

Whether you're a life-long quilter or you're starting a new hobby, Grace Company is here to help!

This booklet is a guide on what you must know to master your new software. Regardless of your quilting experience, use the provided fabric panel to make a practice quilt sandwich and follow along with this booklet. You will have plenty of opportunity to use those much-loved fabrics and intricately-pieced tops once you have mastered the use of your new equipment.

Read these instructions, refer to them often, and it won't be long before you're quilting like a pro.

Use the notes page at the end of this booklet to write down questions you have along the way and what solutions you found for them.

Now, go have fun!

INTRODUCTION TO AUTOMATED QUILTING

Quilter's Creative Touch 6 (QCT6) is a quilting automation system. In automated quilting, you select an edge-to-edge design, tell the software where you want it on the quilt, and then the system stitches it out for you.

An **edge-to-edge** design, also called a pantograph, is a design element that is repeated across a quilt. Automated edge-to-edge quilting allows a quilt sandwich to be quickly stitched together with professional-quality designs.



Edge-to-Edge Design

QCT6 Edge-to-Edge specializes in quilting a single edge-to-edge row at a time. If you'd like to quilt multiple rows with minimal setup or embellish your quilt with block designs, check out the upgraded tiers of QCT6 on Graceframe.com.

FOCUS QUESTIONS

- What is the safe area, and why is it critical to the safety of my machine?
- Why are the placement marks so important?
- Why do I need to keep track of which fabric edges are within the rails of the frame?

VOCAB REVIEW

Edge-to-Edge: A design is repeated across the quilt from one side to the other. It is also sometimes called a pantograph.

BEFORE YOU START:

Fully set up your frame, machine, and Quilter's Creative Touch (QuiltMotion) hardware. Install and register Quilter's Creative Touch 6 Edge-to-Edge. Complete any panels that came with your frame or machine first.

USING THE PANEL

Quilter's Creative Touch 6 came with a fabric panel to use for practice. The panel is a stand-in for a quilt top, so that you can get the hang of your new software without the pressure of stitching directly into your latest masterpiece. The steps in this booklet can be repeated as many times as you like with scrap fabric for additional practice and fun.

The more you practice, the more your confidence will grow!

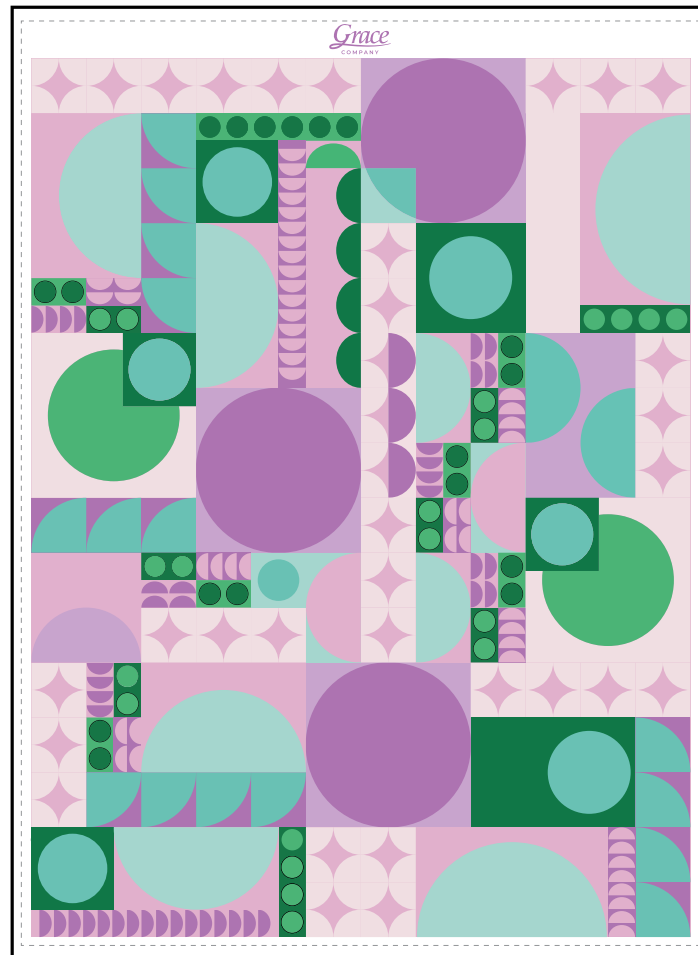

WHAT YOU'LL NEED:

- The quilt panel (came with QCT6)
- The instruction manuals for your frame, machine, and QCT6
- Fabric for the quilt backing (sizing discussed in Lesson 1)
- Batting
- Measuring tape or 12-inch ruler
- Scissors
- Project sticky notes (came with QCT6)
- Stickers (came with QCT6)
- Pen or marker
- Rotary cutter (optional; scissors will work)
- Thread snips (optional; scissors will work)
- Pins
- Thread
- Spare full bobbins

1

Lesson One: Getting Ready to Quilt

KEY CONCEPT

The dimensions of your quilt's backing and batting depend on the style of your quilting frame.

To prepare your panel, you need to make a 'quilt sandwich.' A quilt sandwich is made of a quilt top laid over a layer of batting and backing fabric. The size of the backing layer of the sandwich depends on the type of frame you're using and whether or not you have cloth leaders. See your frame's instruction manual for backing and batting measurements.

PRACTICE STEPS

To prepare the panel for quilting, you will need:

- Your frame's instruction manual
- Supplies for installing a quilt sandwich (see your frame's instruction manual for the complete list)
- Your quilting or sewing machine's manual
- The quilt panel
- Backing
- Batting
- Rotary cutter and mat or scissors
- Measuring tape or 12-inch ruler

- 1 Check your frame's manual for instructions on assembling the quilt sandwich and placing the fabric on the frame. Follow the steps for cutting the backing and batting to the proper length.

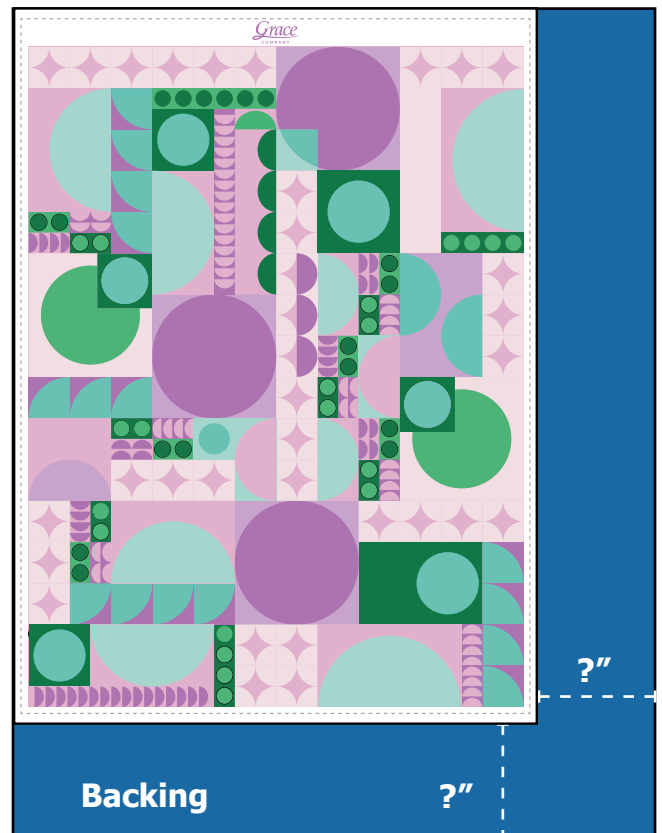
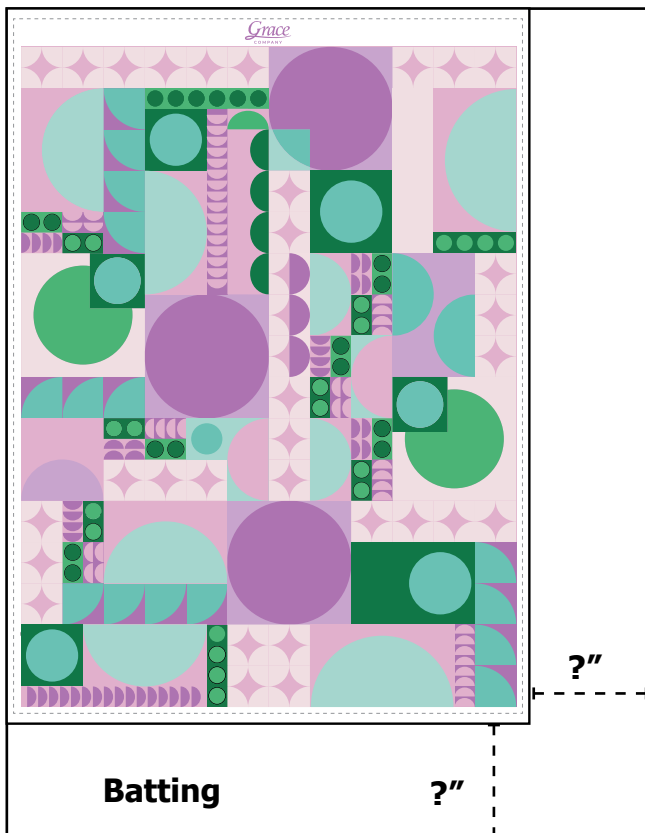

- 2 Attach your quilt to your frame so the Grace Company banner is at the top.

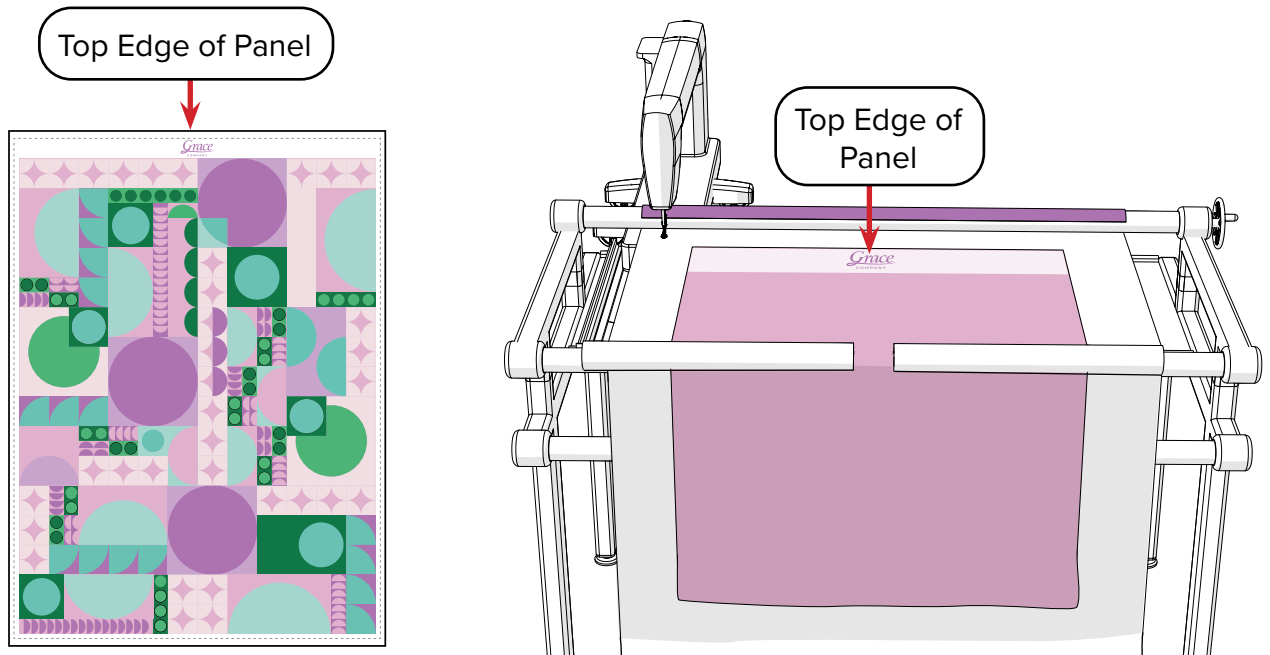

Note: See your frame's instruction manual for details on placing fabric on the frame.

- 3 Position the edge of the panel or quilt-top so that it is about 4 inches from the take-up rail. You want the machine's needle to reach a few inches over the top edge of the panel without your machine bumping into the take-up (back) rail.

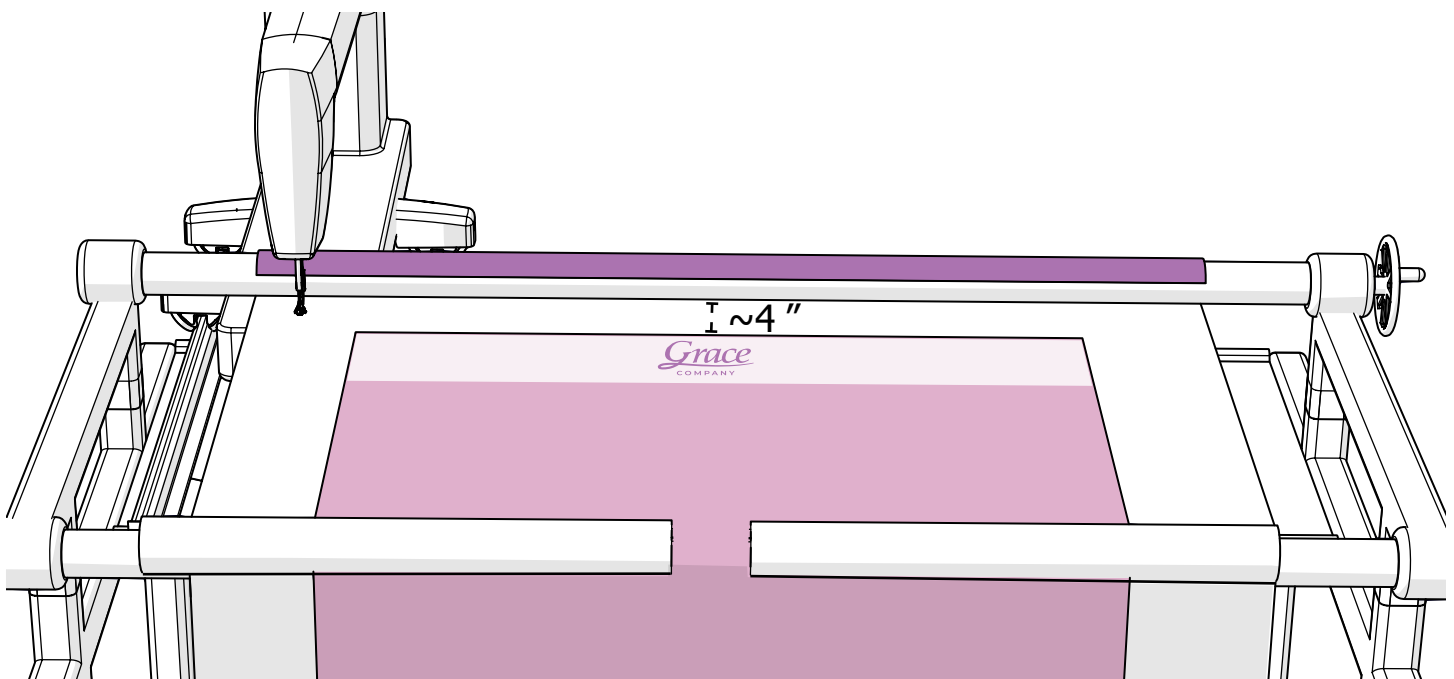

- 4 Thread your machine, wind a few spare bobbins, and load a bobbin into the bobbin case.

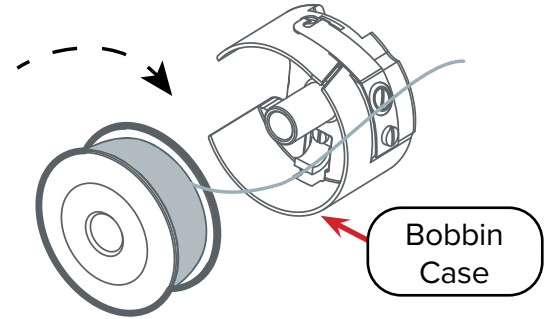
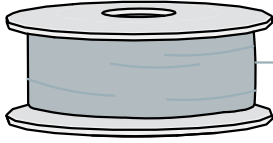

- 5 Give your quilting setup a once-over and check that everything is ready to quilt. Here are a few things to check that:

- that the belts are well tensioned
- that the tracks and table are clear of debris
- that your machine, automation hardware, and tablet are all plugged in and powered on

If you haven't used your machine since installing Quilter's Creative Touch, move your machine around on the frame to make sure it has a full range of motion. It should not pull on or run over any cords.

2 Lesson Two: Tacking Down Your Edges

KEY CONCEPT

Tacking down your quilt-top edges prevents your quilt top edges from getting folded over and stitched down.

Tacking down the edges of your quilt prevents automation from folding it over and stitching down the folds. Remember, once the machine starts stitching, it doesn't know if something goes wrong.

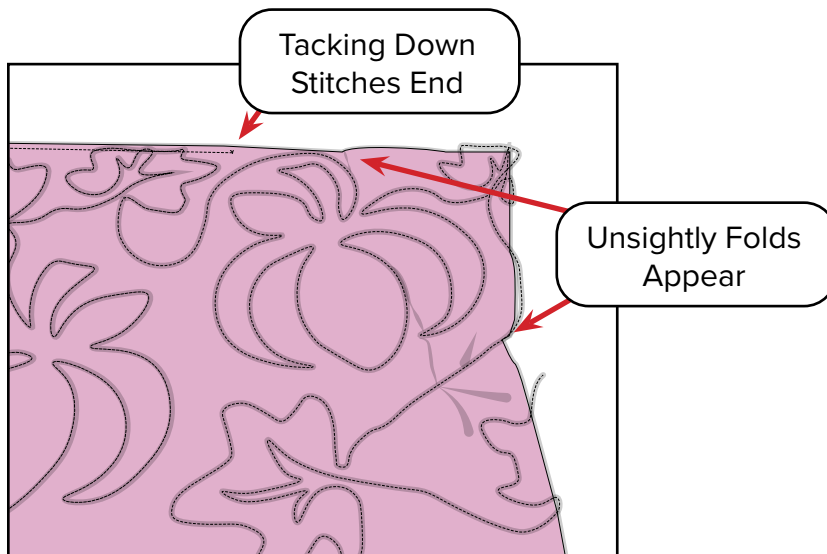

Tack down any edges every time you shift your fabrics—before you start quilting your next row of designs. Not only will this prevent problems like the one in the picture to the left, but tacking down your quilt-top edges also minimizes fabric shrinkage. As you fill up your quilt, the stitches will start to gather in the fabric and scrunch it up. If the edges are stitched down, they can't get pulled in as far.

PRACTICE STEPS

You will need:

- Thread (installed in machine)
- Wound bobbin (installed in machine)
- Scissors or thread snips

- 1 Position your machine's needle along the left edge of the panel, as far forward as the machine will go.

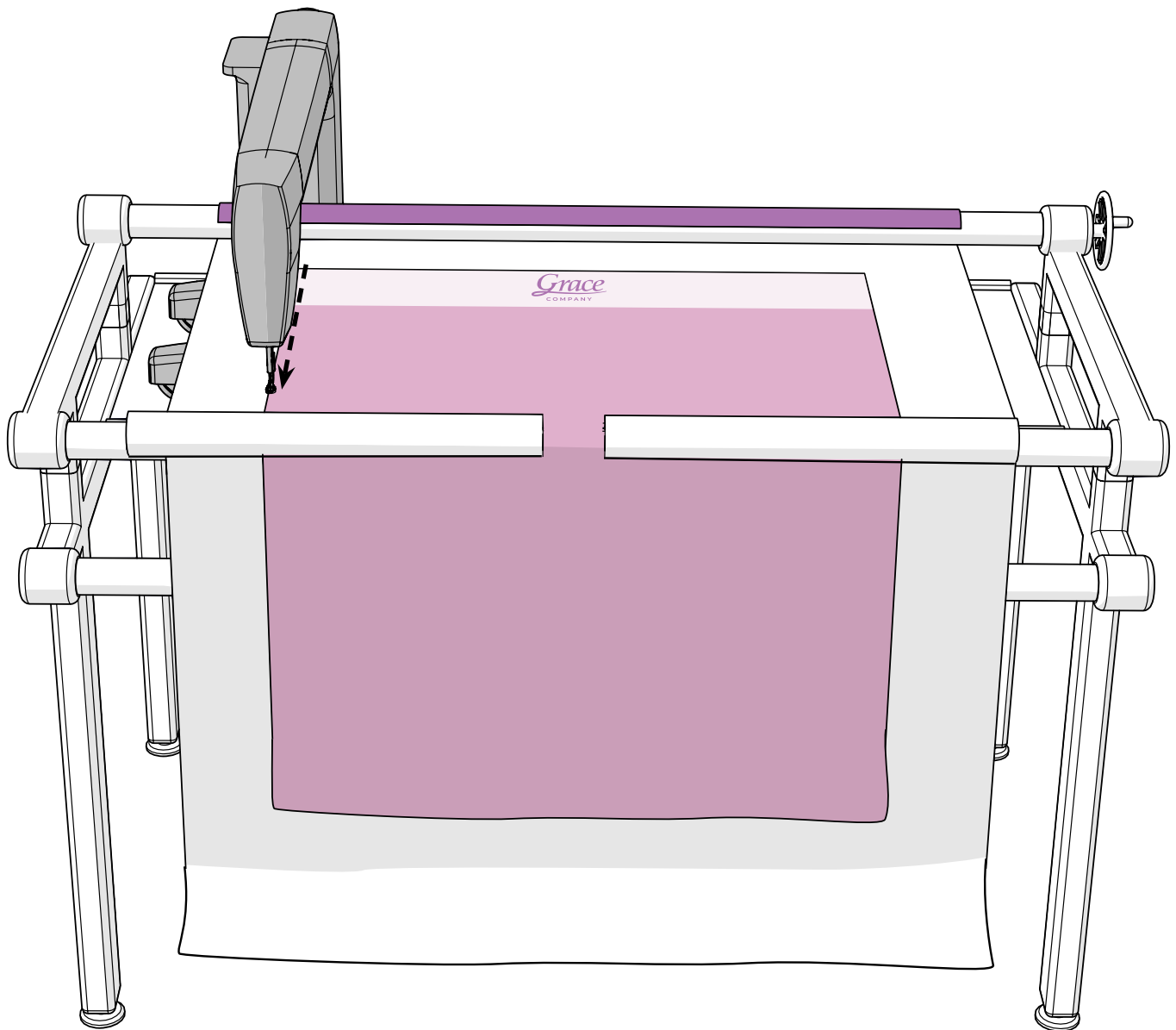

2 Choose a desired stitch length and quilting mode on your machine if those options are available.

3 Now it's time to pull up the bobbin thread.

Every stitch made with a sewing machine has two threads: the top thread (from the cone or spool on the machine) and the bottom thread (from the machine's bobbin). When you first start stitching, the tail of the bobbin thread is underneath the quilt. Since you can't see it, it's easy to stitch over the tail and end up with an unsightly bunch of thread under the quilt. 'Pulling up the bobbin thread' is the strategy to bring the bobbin thread up to the top of the quilt so that it can be trimmed away with the top thread tail. This should be done at the start of every tie-on and the end of every tie-off, and at the start and end of a line of tacking stitches.

a Pick up and hold the top thread tail that is threaded through the needle.

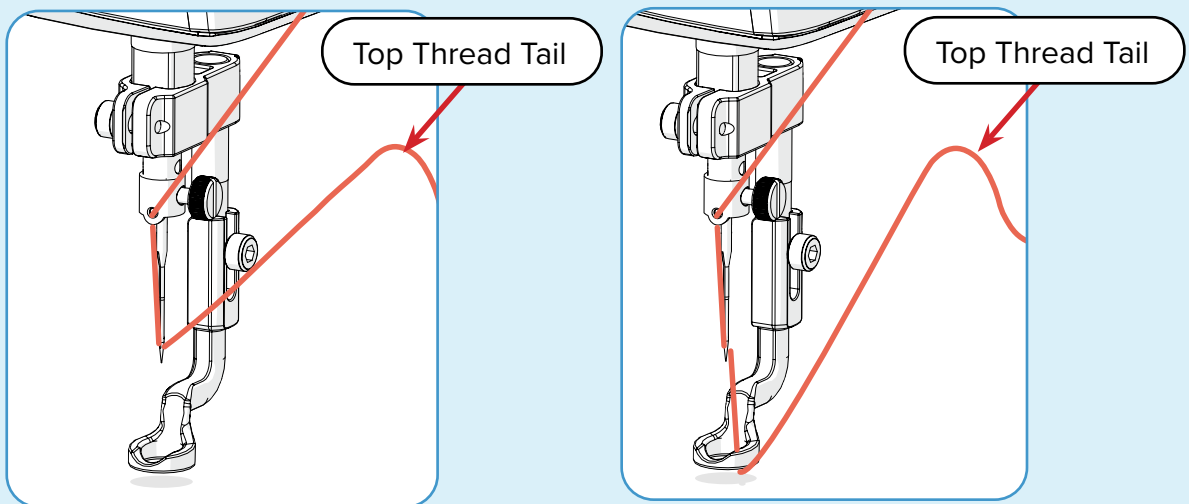

Note: It doesn't matter if the thread is under the hopping foot or not.

b Make sure your needle is positioned as close to panel's left edge as possible.

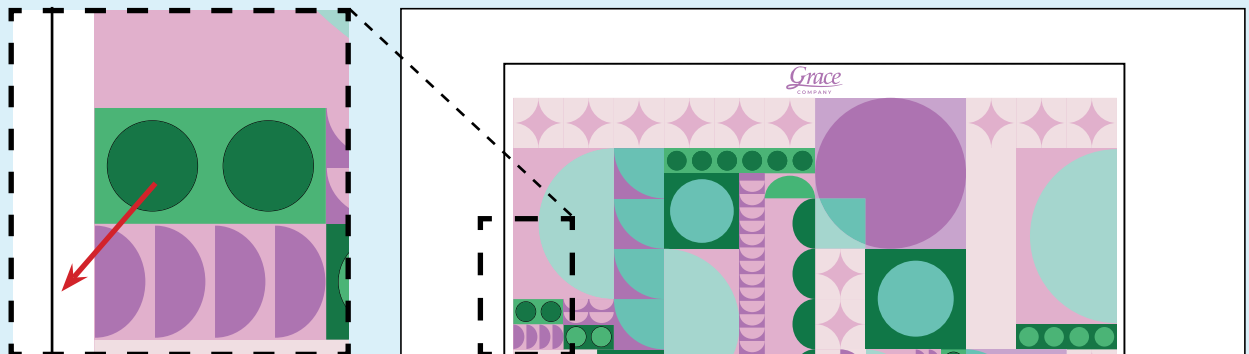

PULL UP THE BOBBIN THREAD (STARTING)

- c While still holding the thread tail, do a single stitch (needle down and back up).

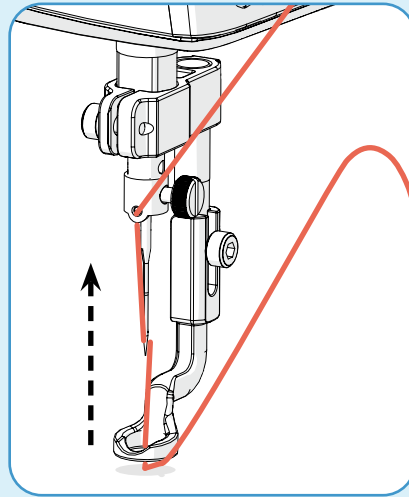
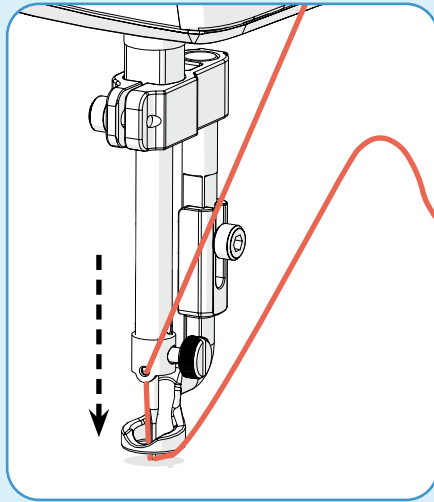

- d Continue holding the thread tail and move the machine away from the stitch. A loop of bobbin thread will be pulled up to the surface. Keep pulling until the bobbin tail completely pops out.

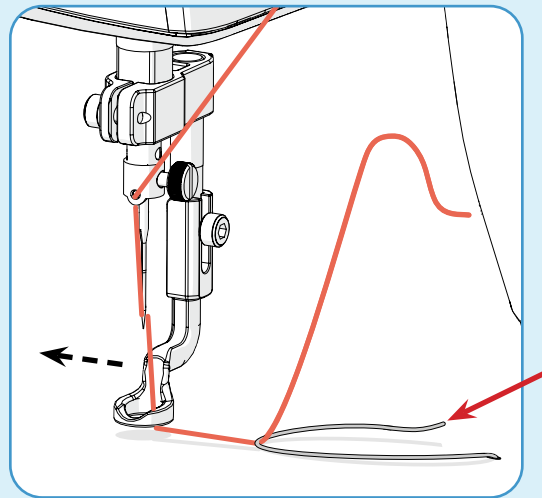
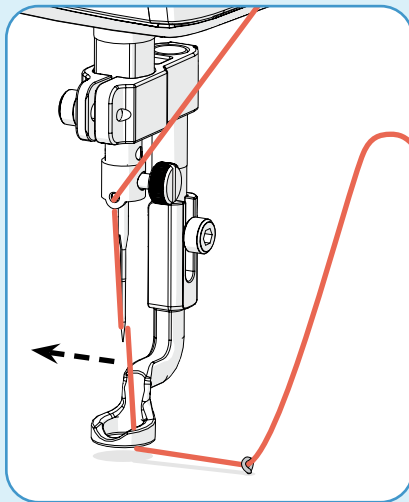

- e Gather up both thread tails and move the machine back to the first stitch.

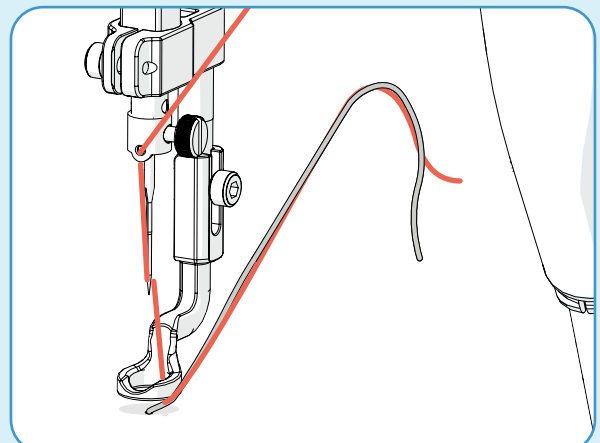
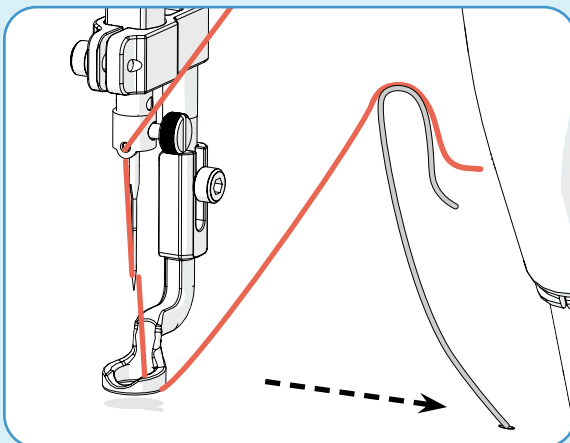

Important: When you move your machine back to the original stitch, slack bobbin thread builds up right under the fabric. Pull on bobbin thread tail until the resistance slightly increases.

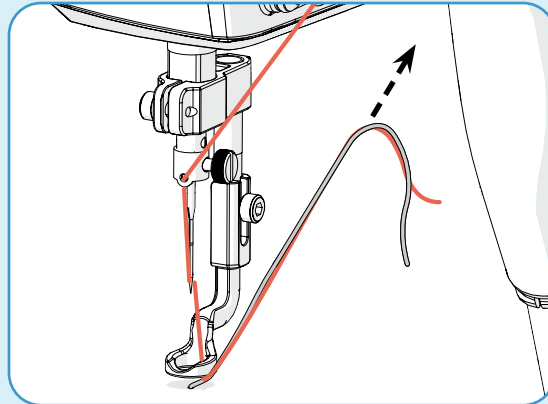

TROUBLESHOOTING

If you have trouble pulling up your bobbin, the bobbin tail might be too short. Remove the bobbin case from the machine and pull on the bobbin tail until there is about 4 inches of thread dangling from the case. Reinstall the case and try again.

- 4 Stitch up along the left edge of your panel. When you reach the top corner, continue to stitch along the quilt top. At the top-right corner, stitch down along the right edge as far forward as the machine can go.

Tip: Stop frequently and check your stitch tension. This is your best opportunity to set your tension because these stitches will be hidden in your finished quilt.

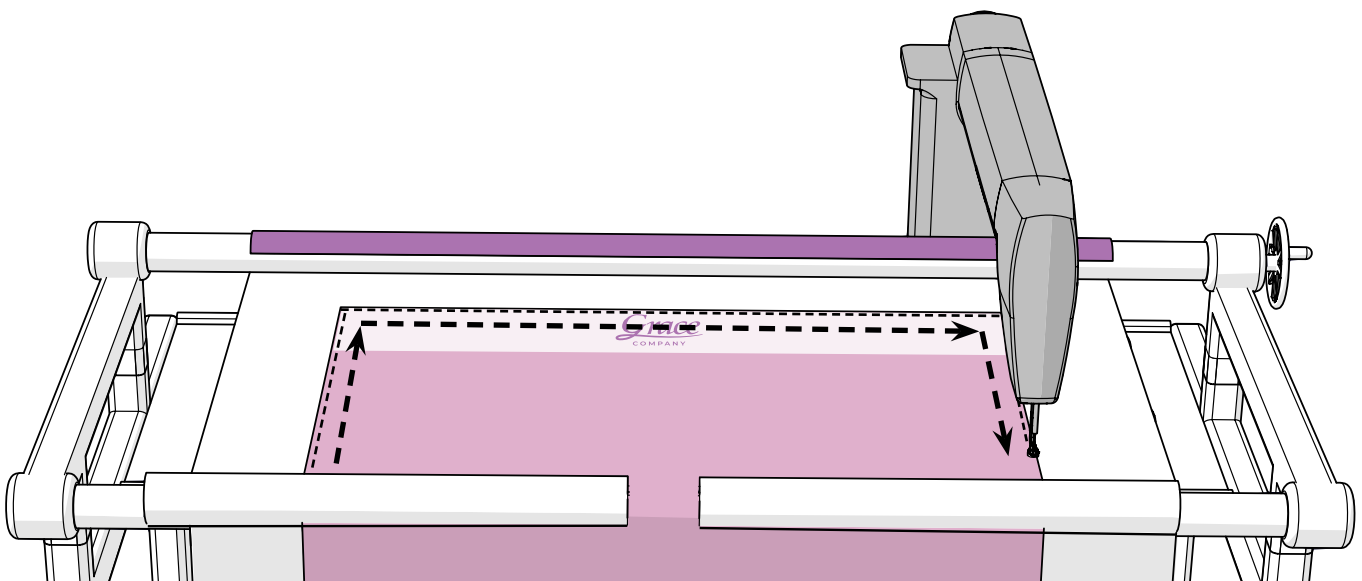

5 The bobbin thread must be pulled up at the end of a line of stitching as well.

a Move the machine away from the last stitch.

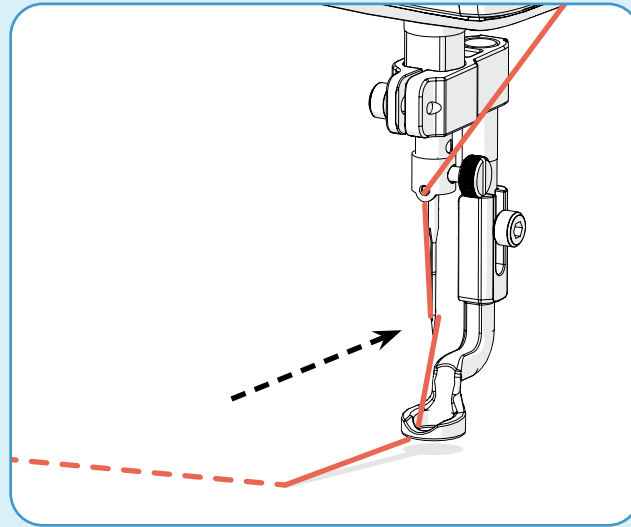

b Hold the top thread to make a loop and return the needle to the last stitch.

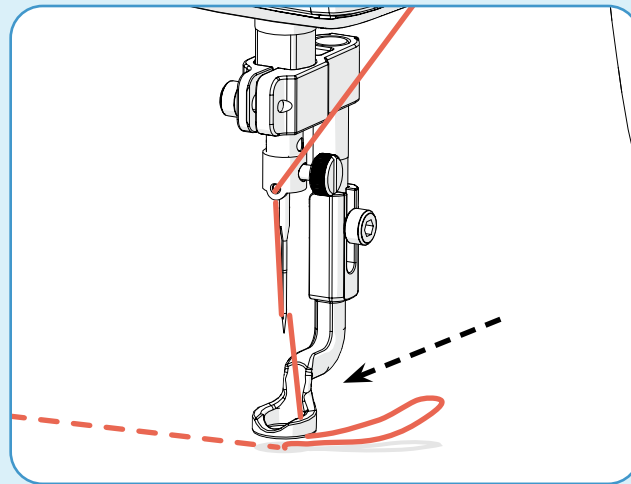

c Still holding the loop, make a single stitch directly over the last stitch.

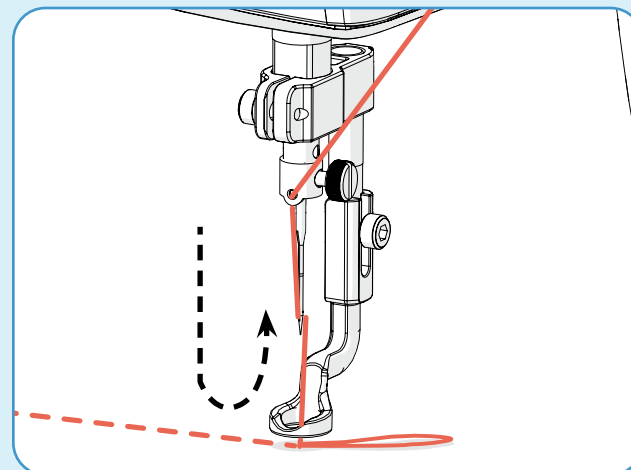

- d Still holding the loop, move the machine away from the last stitch.

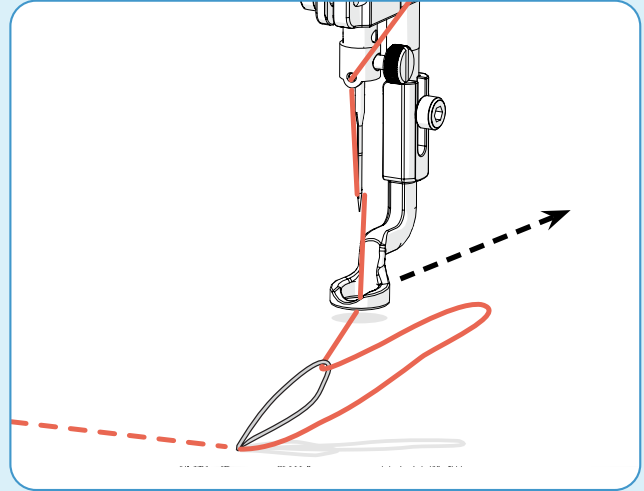
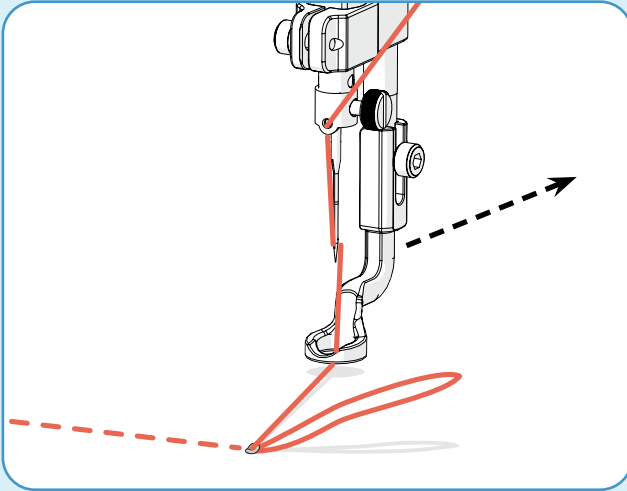

- e Trim away all the threads, close to the tie off or last stitch.

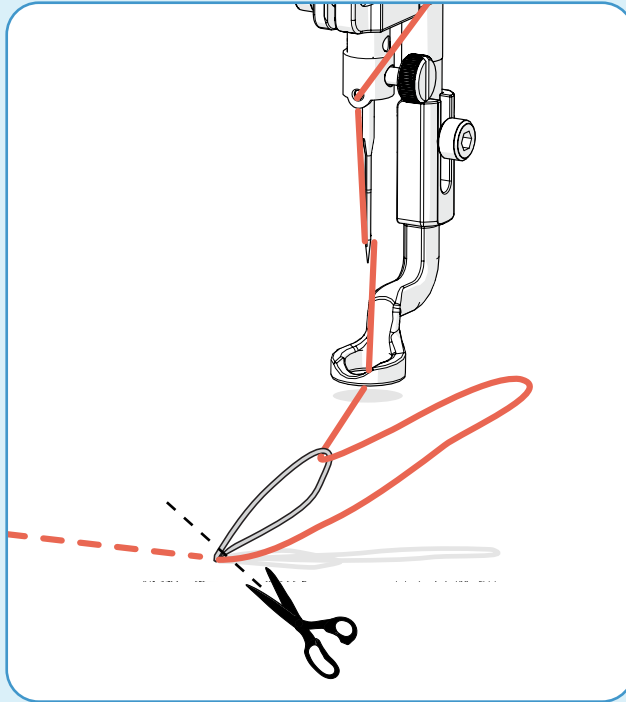

- 6 Now that you've tacked down the edges of your quilt, it's time to open Quilter's Creative Touch.

3

Lesson Three: Opening the Software

KEY CONCEPT

Be cautious when opening your software to quilt. The machine needle must be up, out of the fabric, and away from the frame rails and sides.

You've already opened the software once to register it, but that was in Simulation mode. **Simulation mode** allows you to interact with the software without causing the hardware, such as your sewing machine, to start stitching or moving around on the frame. It allowed you to safely complete the registration process. When you open the software outside of Simulation mode, you must take extra precautions, like making sure the machine needle is away from the frame rails and sides and ensuring everything is firmly plugged in. Take the following steps to open Quilter's Creative Touch 6 and safely navigate out of Simulation mode.

VOCAB REVIEW

Simulation Mode: A mode of the software that allows you to interact with the software without sending commands to the hardware.

PRACTICE STEPS

- 1 On your tablet's desktop, double-tap the Quilter's Creative Touch 6 icon to open the software.



- 2 If your software was last opened in Simulation mode, a message appears stating the software is in Simulation mode, and asks if you'd like to continue in Simulation mode. Tap **No**. This time you will be using the software to quilt and you cannot quilt in Simulation mode.

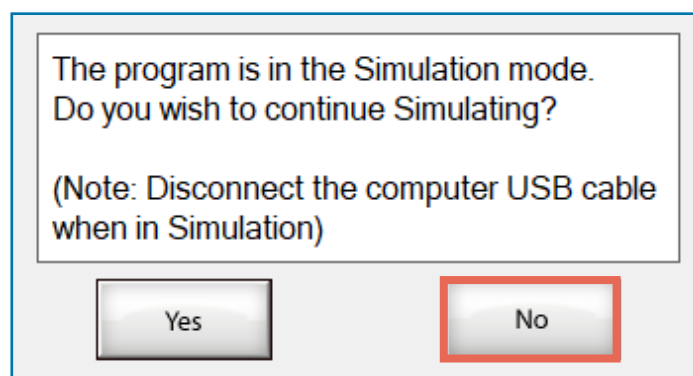

Note: If the messages in this step do not appear, skip to step 3.

We are unable to connect to the automated quilting system.

To try to connect..

1. Power cycle the carriage.
2. Click 'CANCEL'
3. Re-start the program

(You may optionally disconnect then re-connect the USB cable at the computer.)

OR.. you may start the SIMULATION MODE by clicking 'OK'.

OK

Cancel

TROUBLESHOOTING

After tapping **No**, a second popup might appear if the cables are not all plugged in and the software and hardware are not able to communicate.

If this message appears, tap **Cancel** to close the software. Turn off the power on the power strip attached to the bottom carriage and shut down your tablet. Check that all cables are firmly plugged in. Then, restart your tablet, turn the power strip power back on, and open the software again.

- 3 When the software is no longer in Simulation mode, a message appears on the tablet screen asking that you make sure the needle is up and positioned in the center of the frame.

When the software engages with the hardware, the machine moves slightly to test the motors. Make sure the needle is up so it can't catch on fabric and prevent the machine from moving properly. Make sure the machine is clear of the sides and rails so it can move without colliding with the rails.

When the needle is up and the machine is positioned, press **OK**.

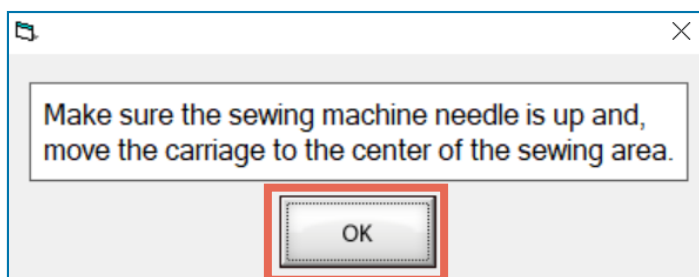

IMPORTANT: The machine moves when you press OK on this screen.

- 4 From the home screen, tap **Edge-to-Edge**.

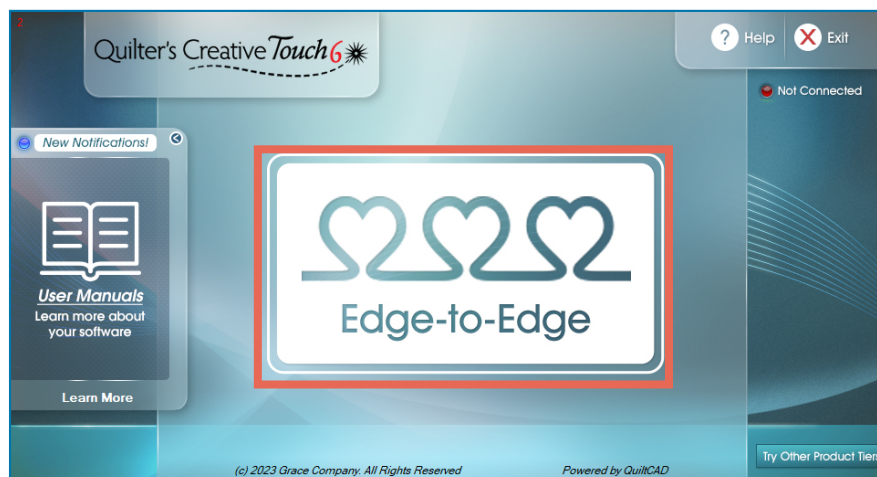

- 5 The Welcome screen opens. Here you can find a QR code and hyperlink to a video course on using the software.

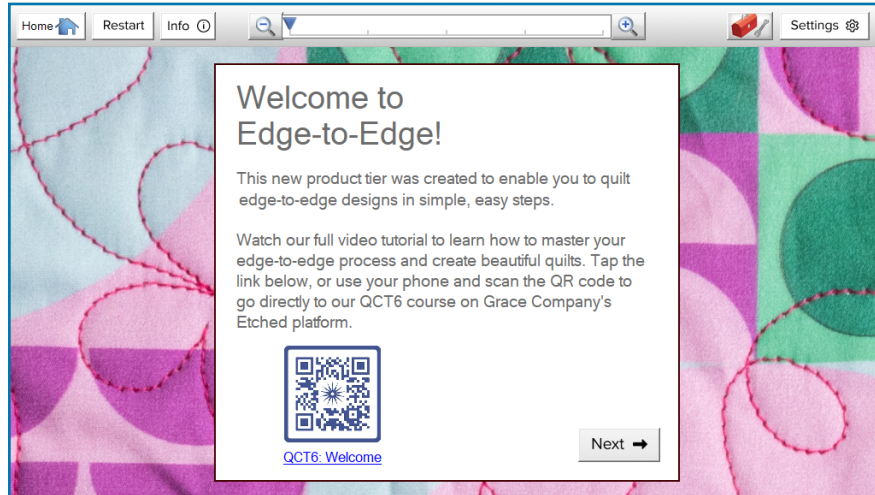

[QCT6: Welcome](#)

WHAT'S A QR CODE?

A QR Code is a type of barcode that carries information your phone can use to locate a specific website. It is a convenient alternative to typing a URL into a browser.

To scan a QR code, open the camera application on your cell phone. Aim your phone's camera lens at the QR code as though you are going to take a picture of it. A notification will appear on the screen. Tap the notification to go to the QR code's destination.

- 6 Tap **Next** to continue through the software.

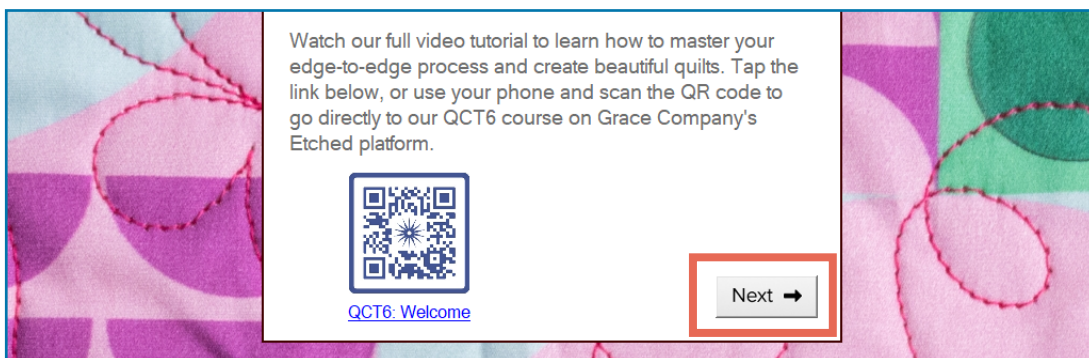

- 7 A window pops up. This is the software tutorial, which has instructions to guide you through the automated quilting process. As you progress through the program, every new screen will have new tutorial information on using that screen.

If you will be following along with this workbook as you quilt, turn **off** the tutorial by tapping **Auto Open**. The same information is explored in these pages, as well as additional information, so it is not necessary to use both.

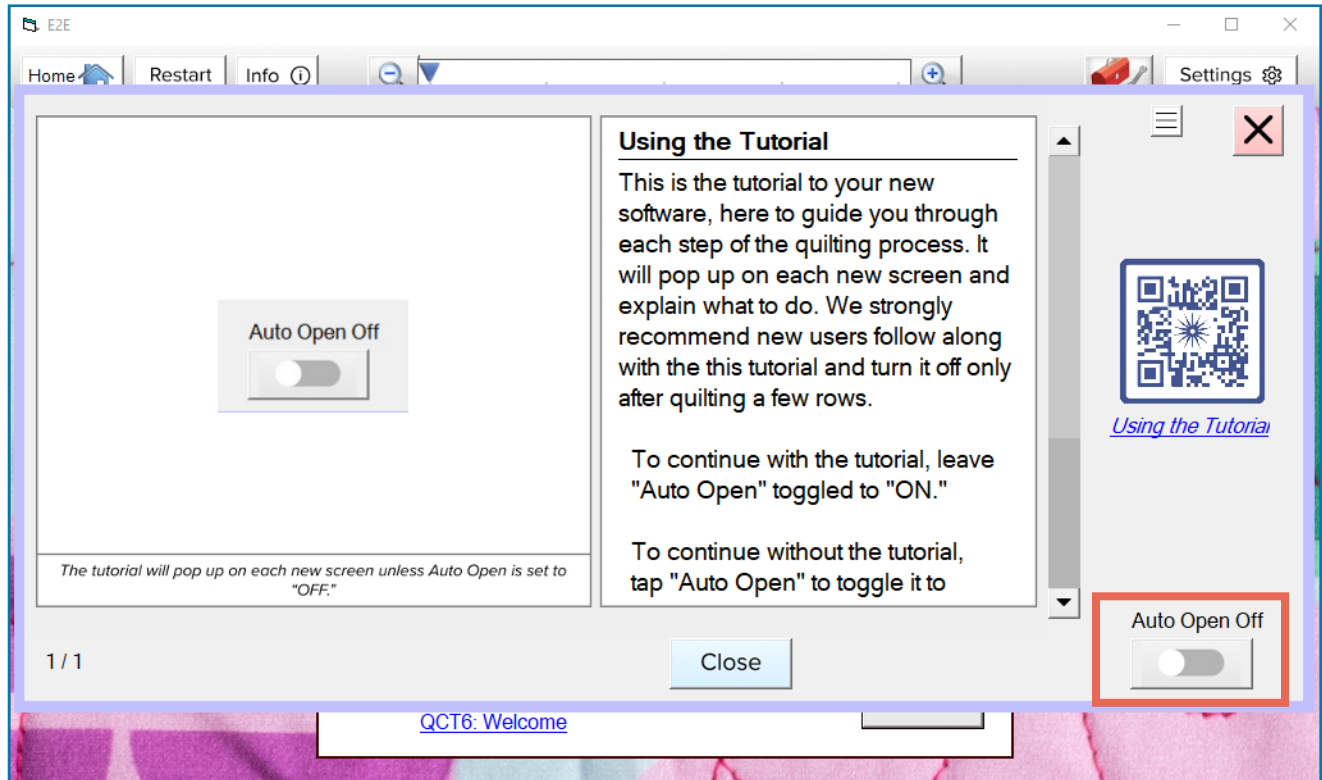

Note: If this window did not pop up when you pressed **Next**, the tutorial Auto Open has already been toggled off. The tutorials and Auto Open toggle can be accessed by clicking Help at the bottom of any Edge-to-Edge screen.

- 8 Close the tutorial by pressing the **Close** button at the bottom of the tutorial screen, or by tapping the **X** in the top-right corner.

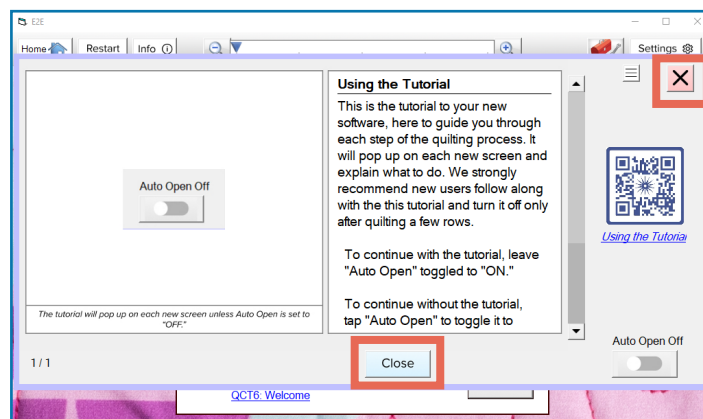

4

Lesson Four: Navigating the Software

KEY CONCEPT

Read the on-screen instructions carefully before touching any buttons.

Quilter's Creative Touch software needs to know where to make stitchings and what stitches to make. That is where you come in. If you have used a computer or a cell phone to access content on the Internet before, you already have the basic skills to operate Quilter's Creative Touch. The software will lead you through a series of questions that enable your machine to stitch out a design.

Take your time making selections and answering the software questions. Before pressing any buttons, read the on-screen instructions and those in this booklet carefully so that you fully understand each action you need to take.

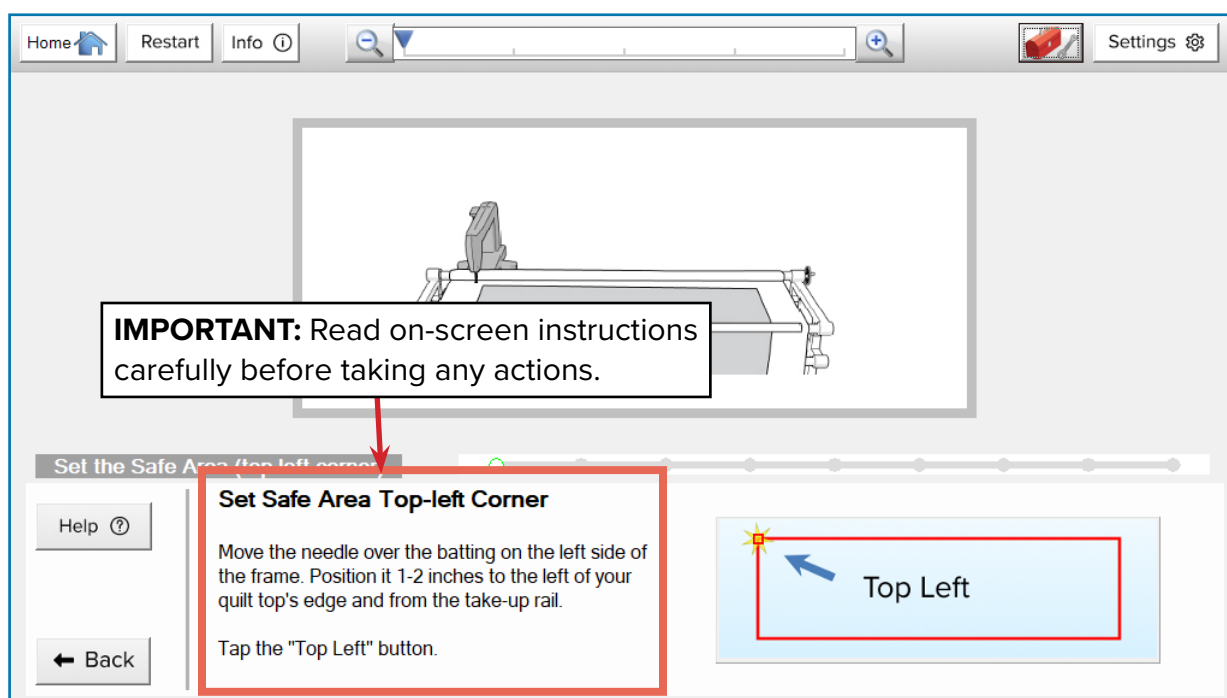

PRACTICE STEPS

- 1 Without taking any actions on the screen, read the instructions and consider what you think you should do.

- 2 Tap the Help button to open the tutorial. This is your first resource if you get stuck. Even if you're 90% sure you know what the software is asking, reading the tutorial information to get confirmation is a great idea while you're still learning the software.

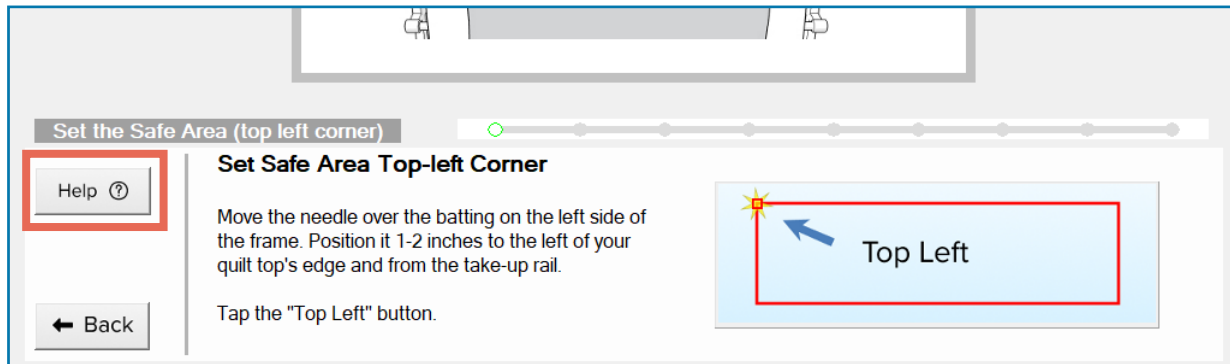

- 3 Read the information in the tutorial and compare it to what you thought the software was asking. Whether your guess was right or wrong isn't important. What is important is confirming that you understand the instructions *before* selecting anything. Some decisions can impact your quilt in ways that you might not expect and could leave you feeling disappointed later. This guide, the on-screen instructions, and the tutorials are designed to prevent that outcome—so thank you for reading!
- 4 Continue to the next lesson for more details on setting your safe area.

5

Lesson Five: Setting the Safe Area

KEY CONCEPT

The area in which your machine can move around the frame without bumping into anything or stitching off the fabric is called the “safe area.”

The safe area is the space on your frame where the automation can safely move your machine without bumping into the frame’s rails or sides. If the machine hits or catches on a frame rail while stitching, your design will not stitch out as expected. You’ll need to pick out stitches and start over.

CAUTION: If the machine sews off the edge of the fabric and into the open air, the machine could jam and break. Setting the safe area correctly prevents these accidents.

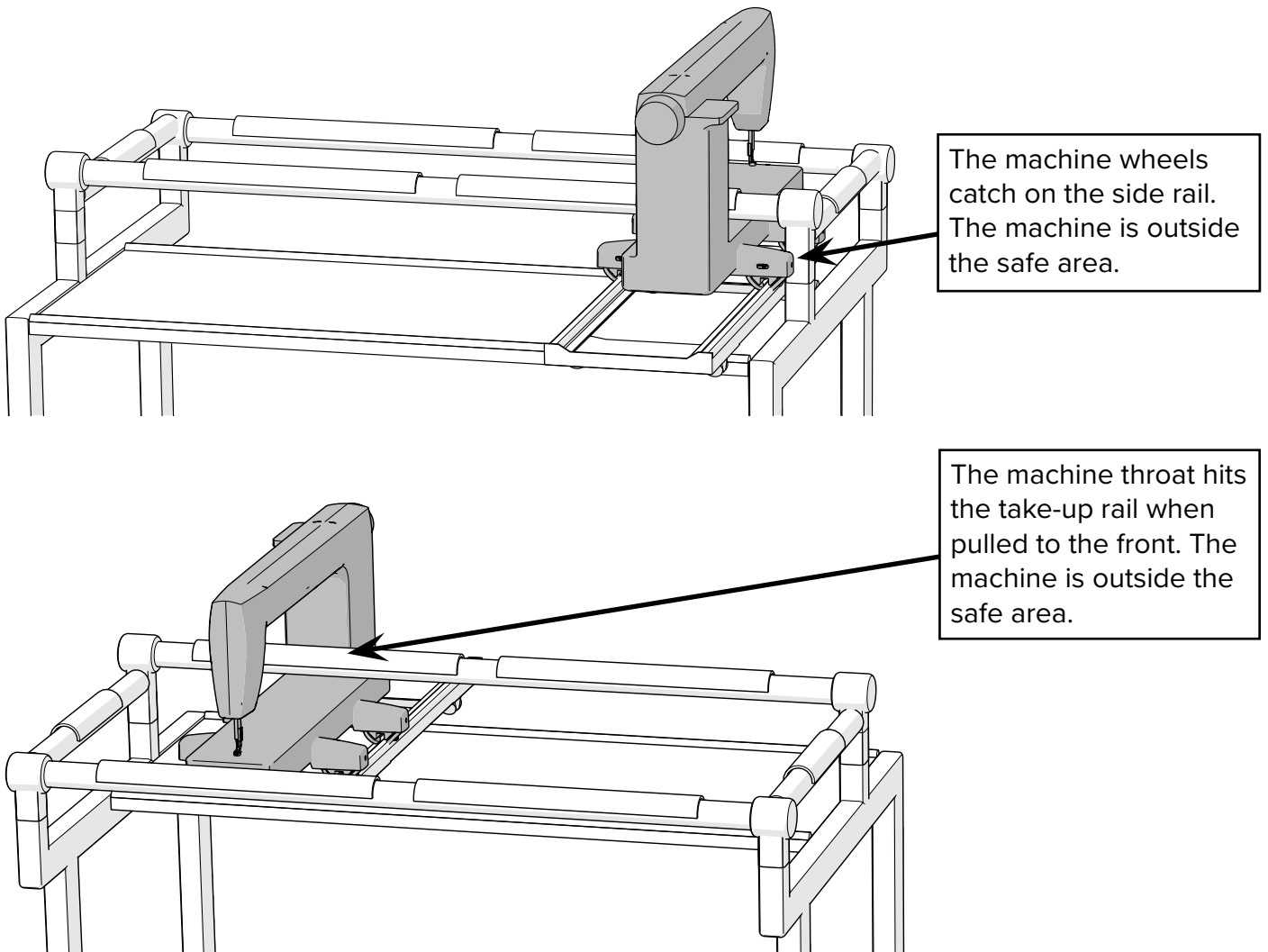

The safe area is different for every quilting setup, which is why the automation software can't tell where the safe area is on your frame without your help. In the following practice steps, you will use your machine to communicate the boundaries of your safe area to the software.

PRACTICE STEPS

You will need:

- Measuring Tape or 12-inch ruler

- 1 Move the machine needle 2 inches from the left edge of the quilt top and 2 inches from the take-up rail. **IMPORTANT:** Make sure the needle is over batting or fabric. Never set the safe area over open air.

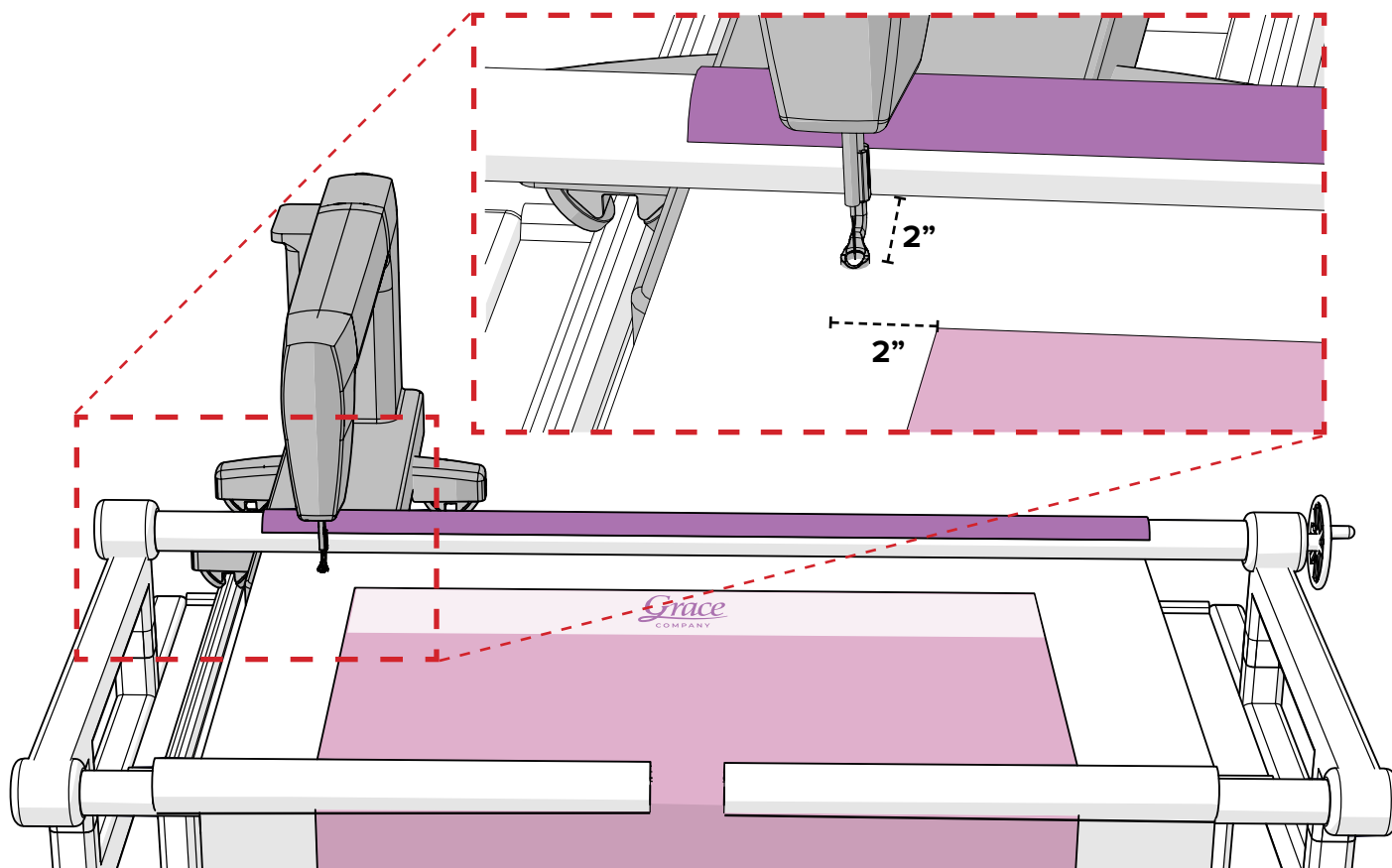

The software tracks your needle as you move it across the frame. In essence, you're using the needle as a pointer to tell the software where you want the back-left corner of the safe area to be.

- 2 Tap the **Top Left** button on the screen to confirm the needle's location as the top-left corner of the safe area.

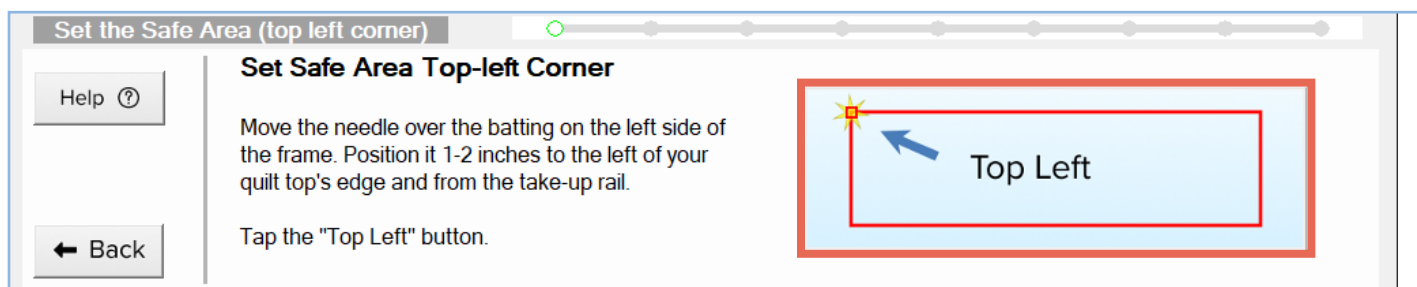

- 3 Move your machine to the right until the needle is about **2 inches** right of the quilt top, as far forward as it can go without the machine throat hitting the take-up rail. Again, only set the safe area over fabric or batting.

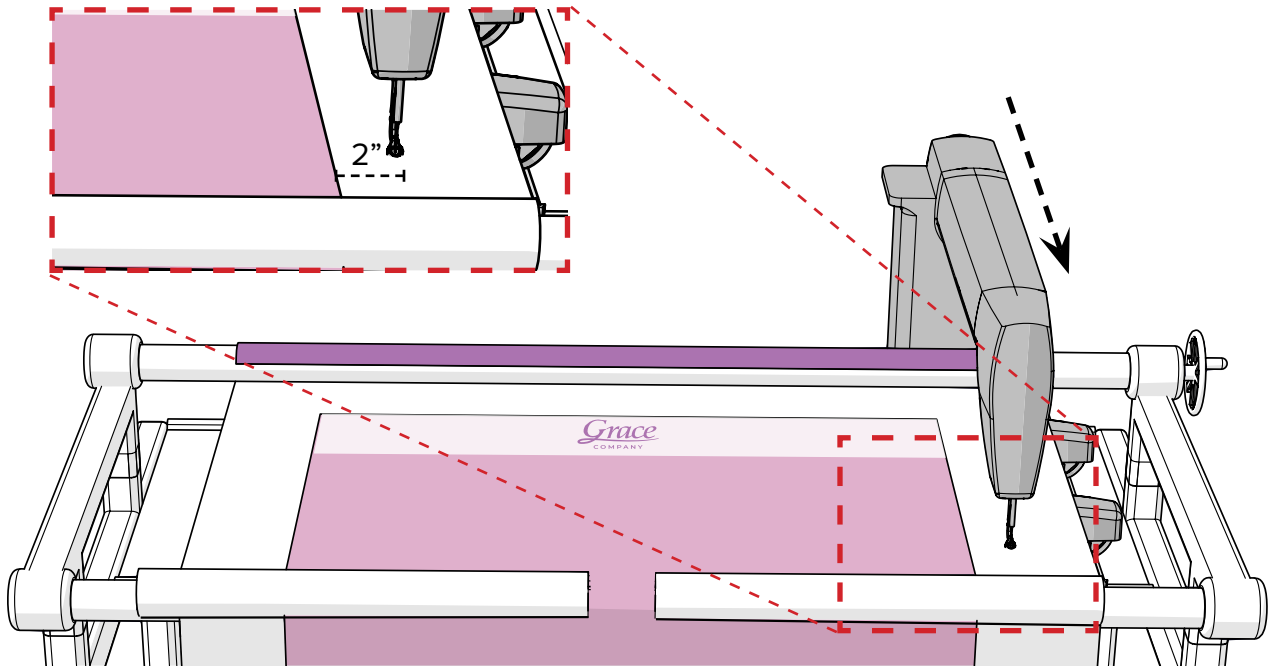

IMPORTANT: Make sure the needle is **at least 8 inches** from the right side when you set the safe area to prevent the machine wheels catching on the side of the frame.

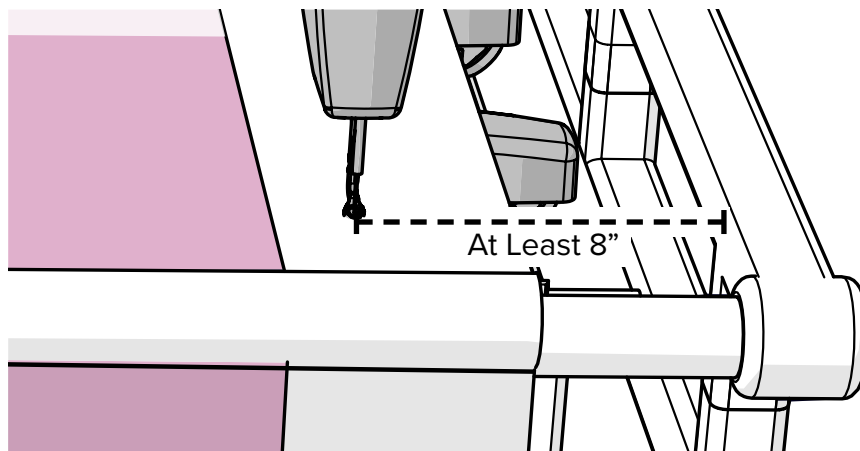

- 4 With the needle positioned, tap the **Bottom Right** button on the screen.

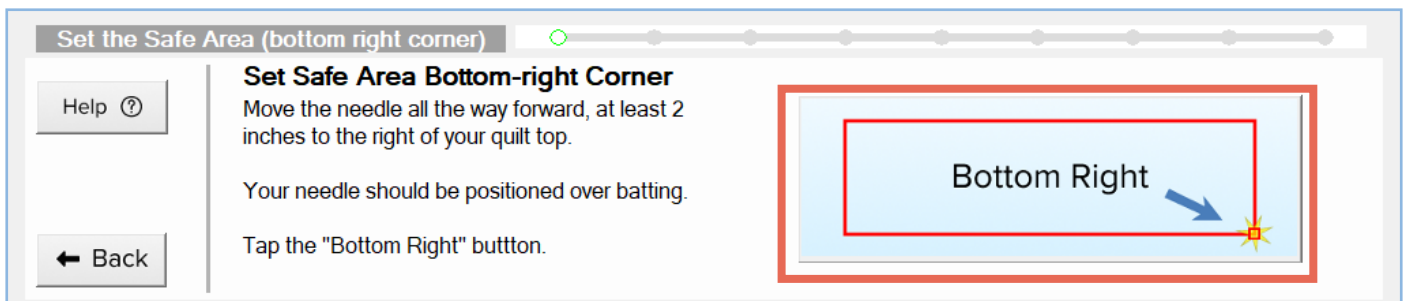

6

Lesson Six: Selecting a Design

KEY CONCEPT

There is more to consider when choosing a design than how appealing it is, such as how densely the lines are packed together.

The design is the repeating pattern that you want stitched across your quilt, and choosing a design is a lot of fun. While the most important thing is that you choose a design that you like, it's helpful to keep a few things in mind.

A design can dramatically alter the overall look and feel of the finished quilt. Highly detailed designs with a lot of lines create a lot of thread build up and hide the loftiness or puffiness of the quilt. These kinds of quilts can look impressive when hung on a wall as a decoration, but might not have the drape preferred in a blanket.

A looser design that leaves a lot of unsewn space creates a puffier quilt with more drape.

Another important factor in choosing a design is the throat space of your machine. Highly intricate designs are often better stitched out larger. Machines with a small throat space might not handle intricate patterns as well. As you follow along in this booklet, consider how the different designs you select alter the look and feel of the quilt and the amount of time it takes to stitch out the designs.

PRACTICE STEPS

- 1 In the Select a Design screen, tap **Select Design**.

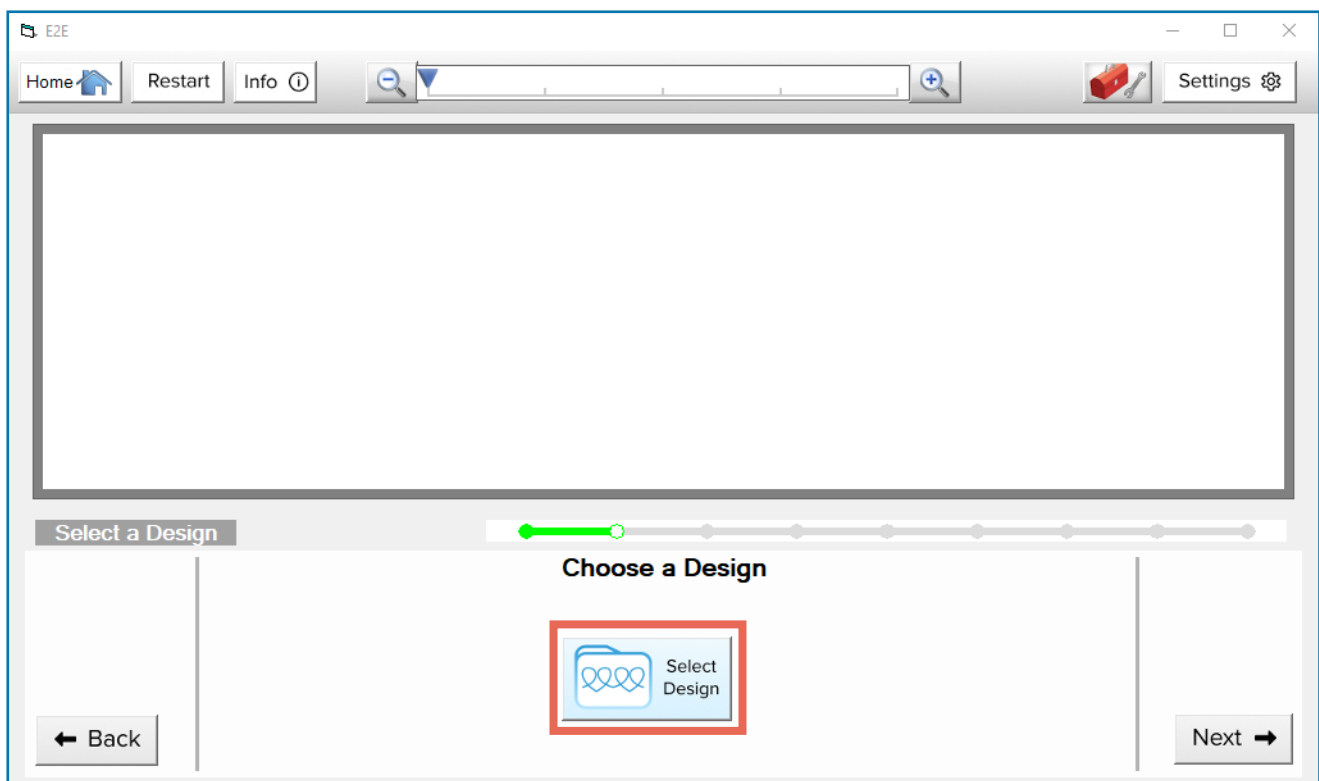

- 2 A window opens with a list of continuous line design files. There are also folders with designs from a few folks that are prominent in the quilting community.

Explore your options and choose a design you like. Tap the **design file** and then tap **Open**.

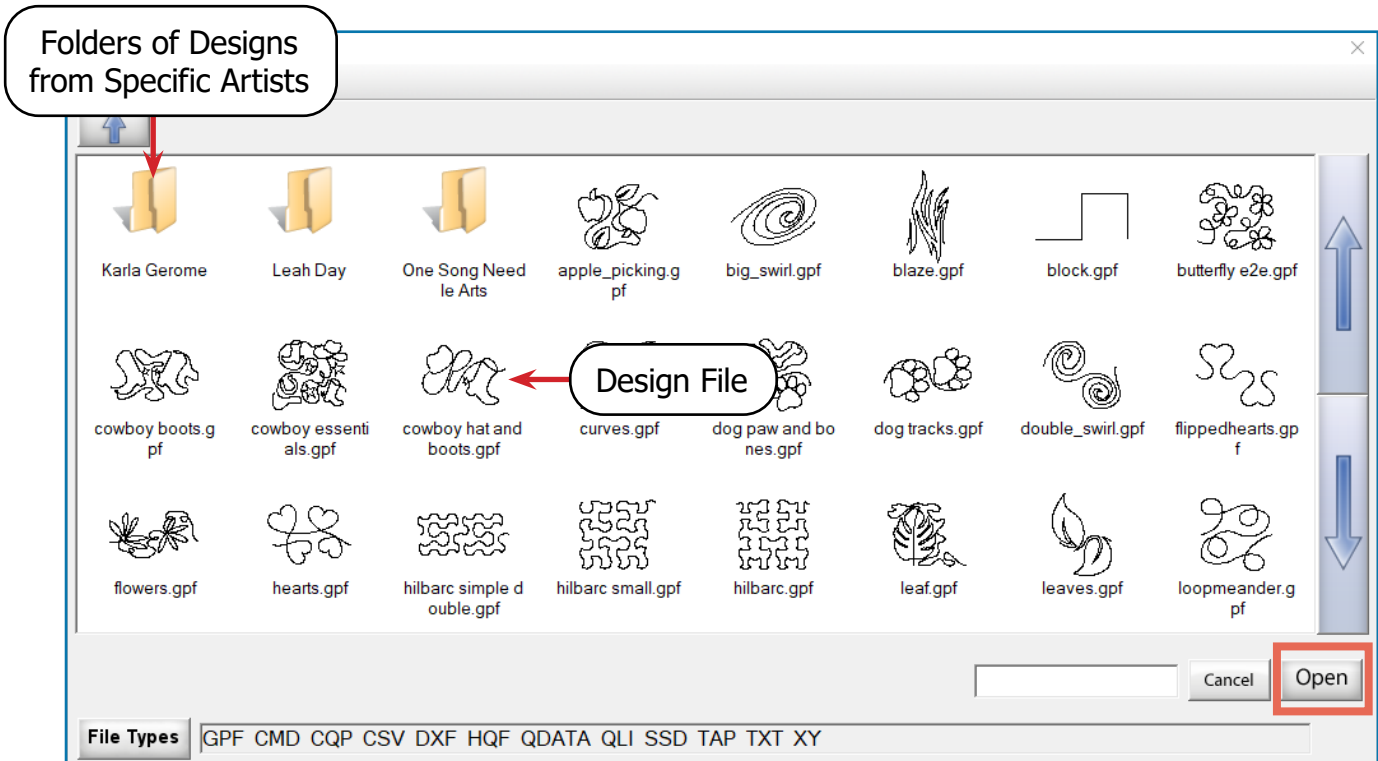

- 3 Back on the Select a Design screen, the **design you selected** displays across the **preview window**. The preview window is a representation of the portion of your quilt inside the frame's safe area. If you like the look of your design, tap **Next**.

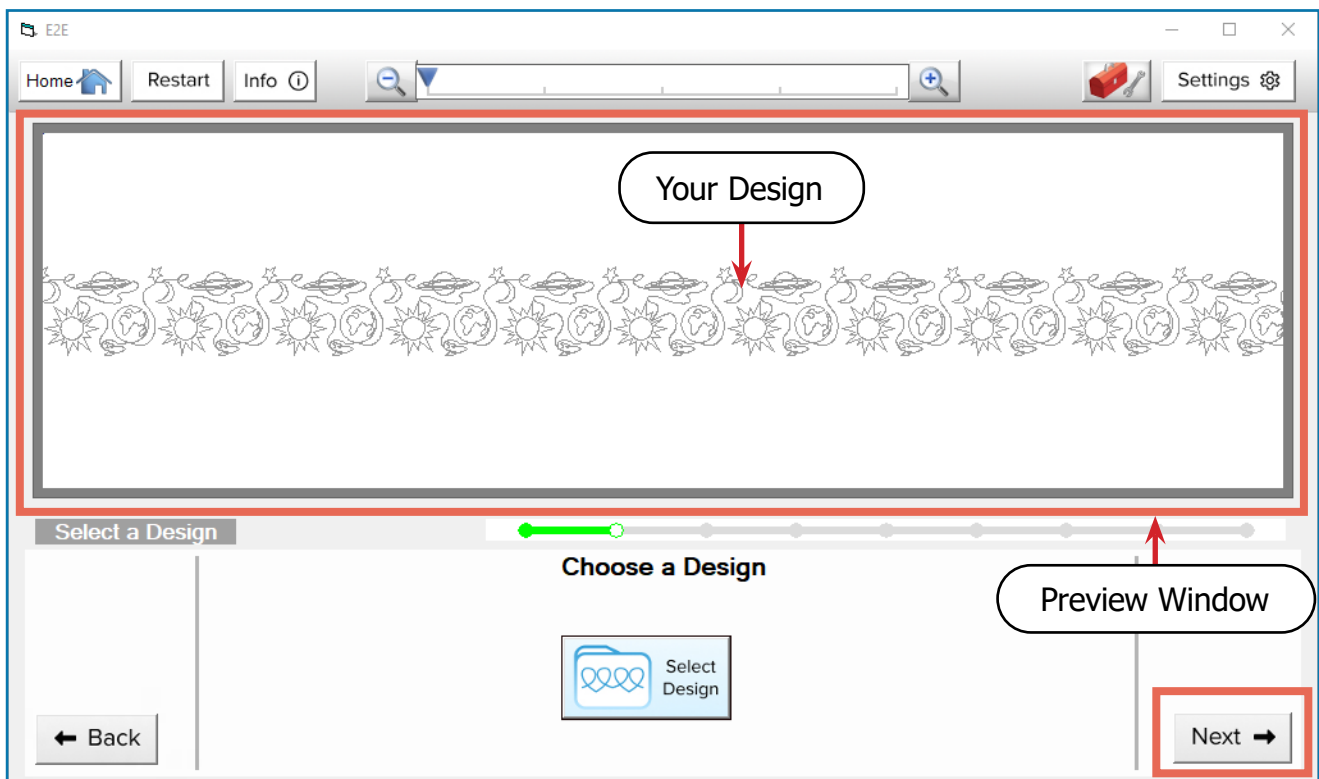

7

Lesson Seven: Setting Your Design Height

KEY CONCEPT

The design height determines how big the design is when it is stitched onto the quilt.

The design height is the distance in inches from the top and bottom edges of a design.

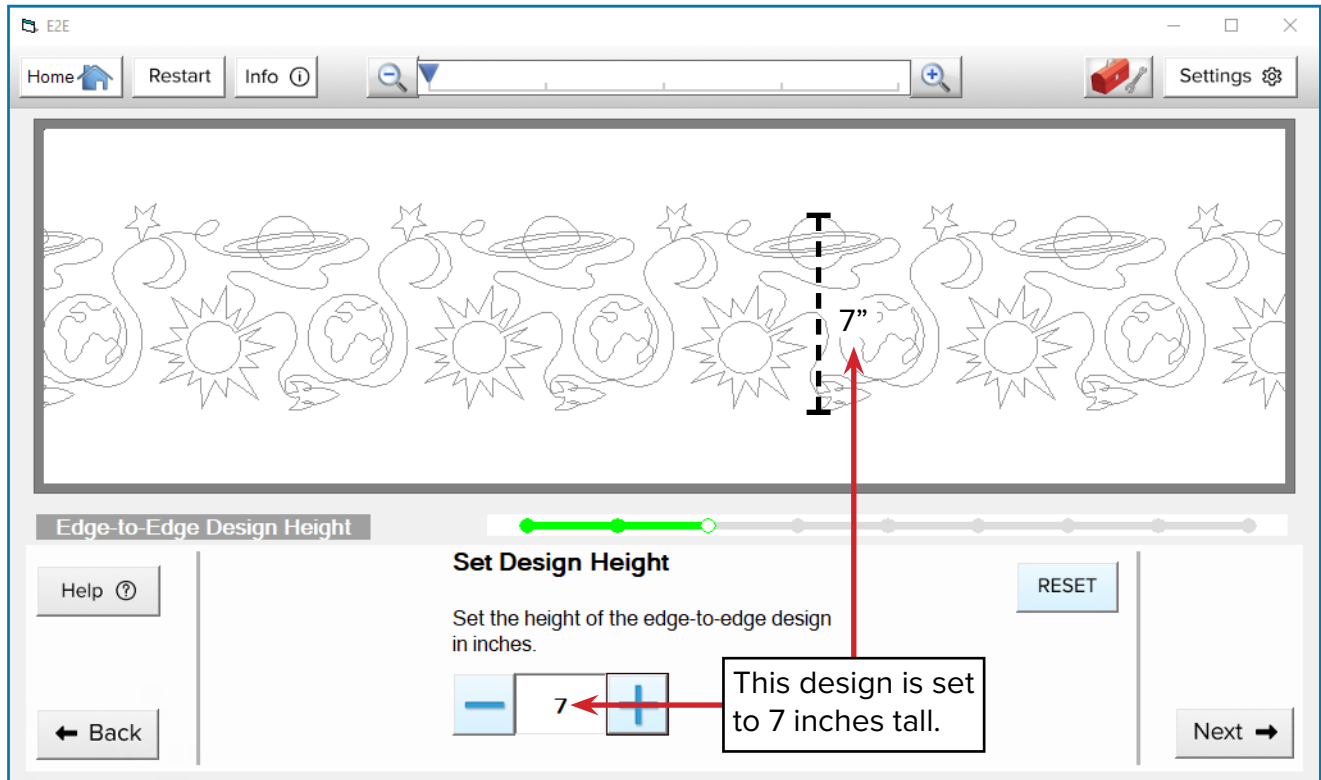

The design is scaled up or down to stitch out at the size that you enter here. In the advanced Quilter's Creative Touch tiers, you can adjust the design width independently from the height. In this tier, the aspect ratio of the original design is preserved, so the footprint of the design grows or shrinks as you adjust the height.

Take the following steps to learn how to choose a good height for your design.

PRACTICE STEPS

You will need:

- A tape measure or 12-inch ruler
- Design Sticky Notes (came with Quilter's Creative Touch 6)
- Sheet of Paper

- 1 Lay your ruler down on your quilt-top and try to picture how your design might look stitched out at different sizes.

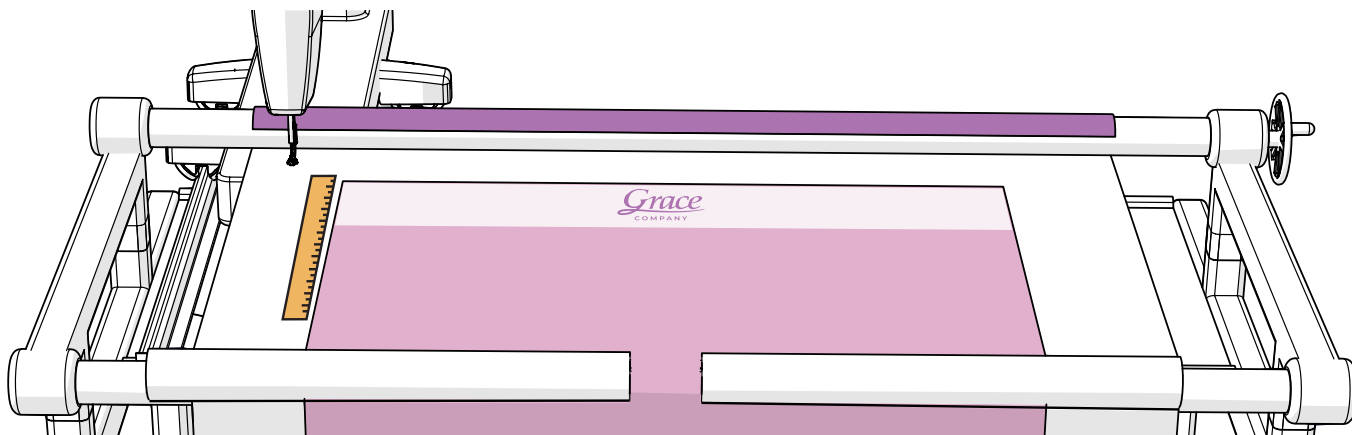

- 2 When you think you know what size would look good, cut or fold a piece of **paper** to that height. **Tip:** If the height is under 3 inches, use one of the sticky notes that came with your kit.

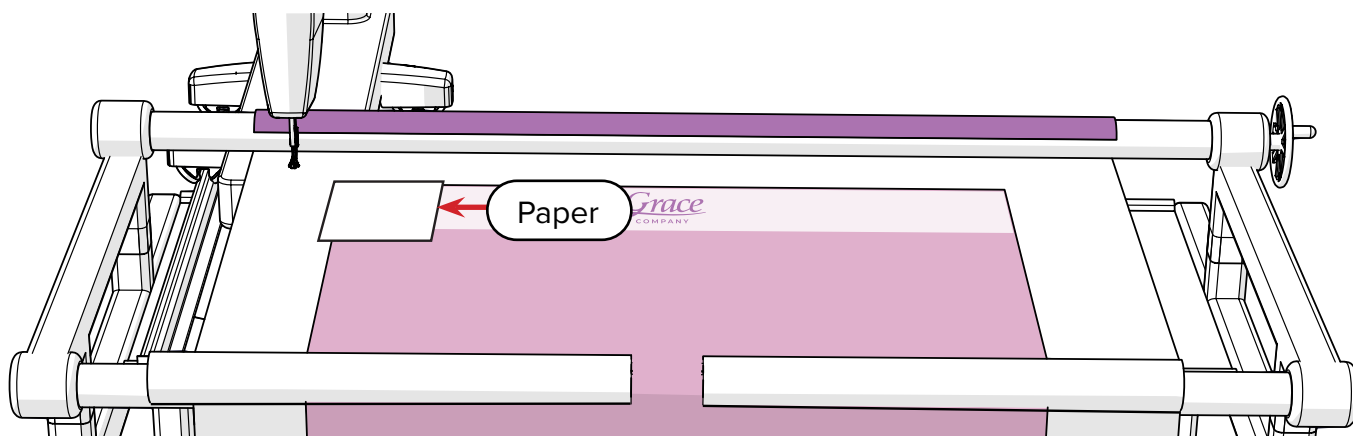

- 3 Lay the folded paper down on your quilt top. Pull your machine all the way forward and compare the space between the quilt top edge and the machine's needle. How many rows of the design height you chose will fit in that space?

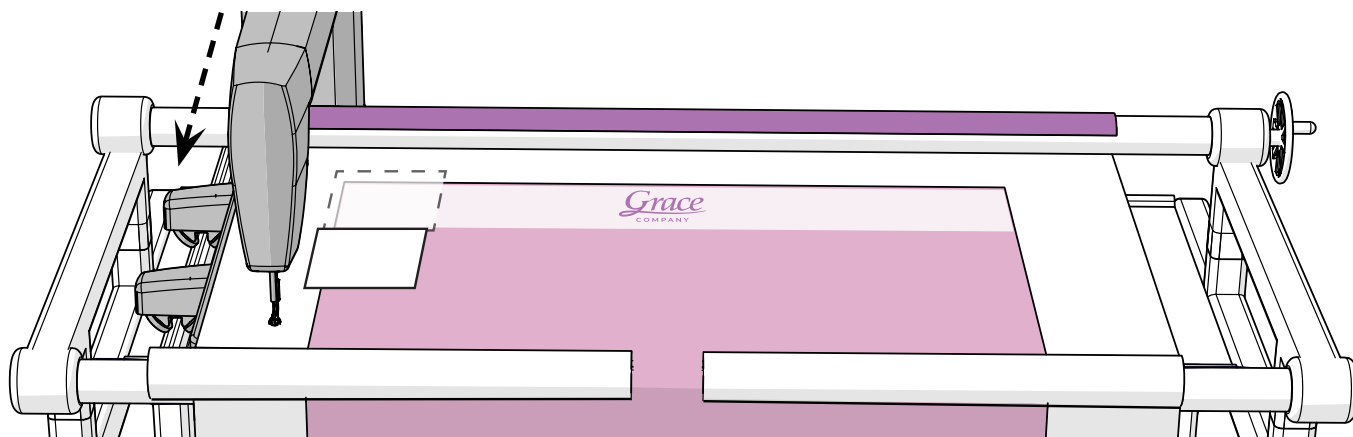

GOT A BIG QUILT?

As you roll up your quilt, the quilt roll on the take-up rail eats into the available quilting space. The bigger and puffier the quilt, the more space it takes up. For example, at the beginning of your quilt, you might have 10 inches of quiltable space between the two rails, but only have 7 inches by the end. This could be a problem if you set your design height to 8 inches.

If you're working on a large quilt and plan to stitch out your design large, try rolling the fabric all the way onto the take-up rail and follow steps 2 and 3 to test your desired design height. This will save you from finding out your design height is too large at the end of the quilt. **Tip:** You can also set your safe area this way, but it might be easier to just re-set your safe area part way through the quilt.

- 4 When you're satisfied with the height you've chosen, tap the number box on the screen and a text entry box opens.

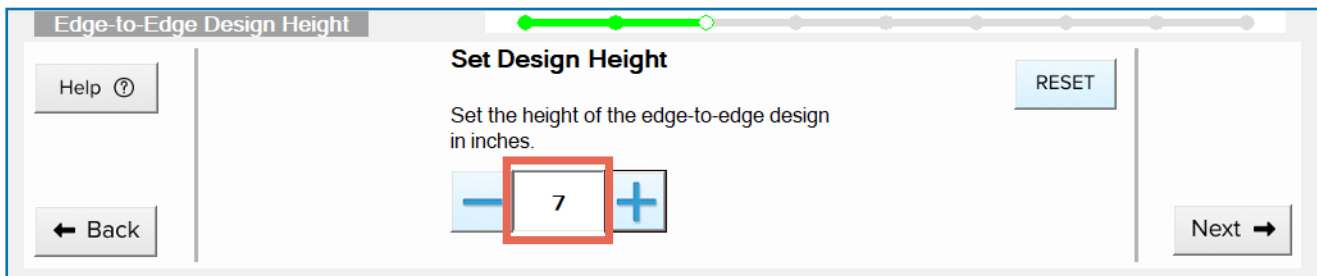

- 5 Tap the **number** buttons to enter the closest whole number to the height you've chosen. Tap **OK**.
Note: If you're a wizard at converting fractions to decimals, you can enter a decimal number here as well.

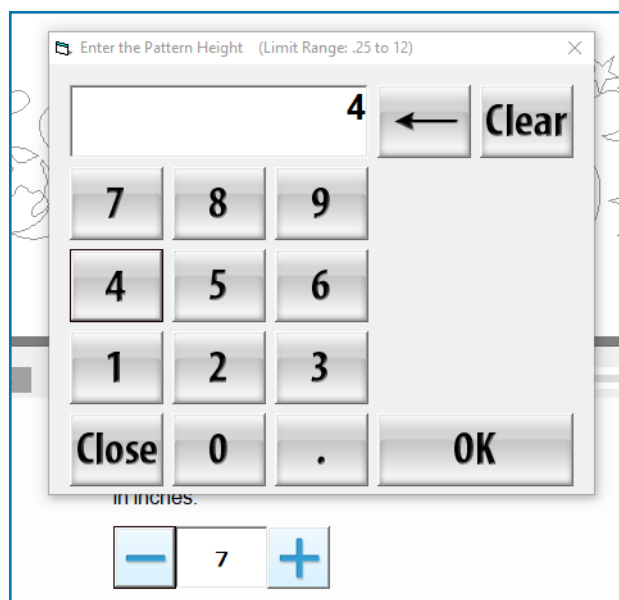

- 6 If needed, adjust the height by $\frac{1}{8}$ -inch increments by tapping the **plus** and **minus** buttons.

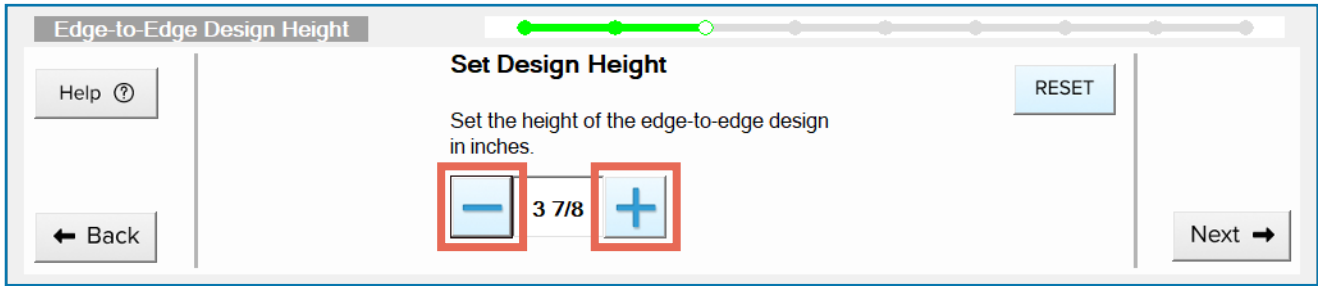

- 7 Press **Next** when you're ready to continue.

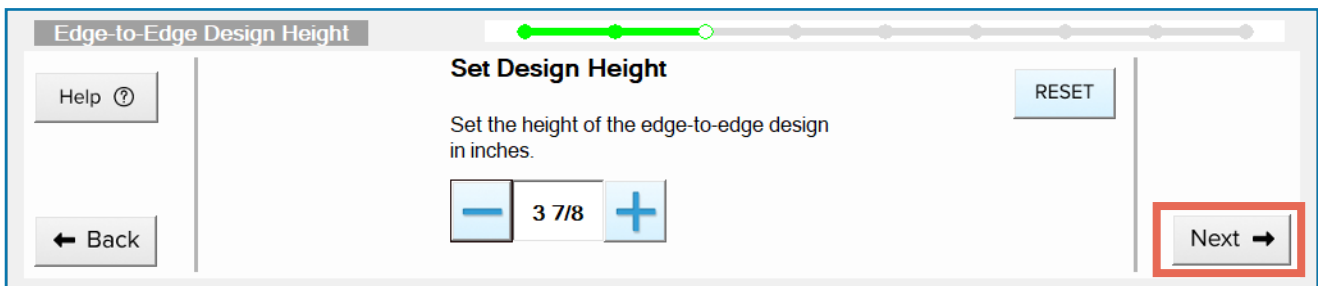

EXTRA CREDIT

In the next lesson, you'll learn about row spacing and nesting your designs. Consider how the spacing of your designs impacts the overall height of the rows of designs.

8

Lesson Eight: Adjusting Your Row Spacing

KEY CONCEPT

Design spacing determines how closely the each row of designs is stitched next to each other.

Designs must be spaced out so they don't intersect with each other (unless you want them to intersect, of course). Many designs will have all the space they need between rows built in by the artist that created them. However, you may feel they look better with more or less space.

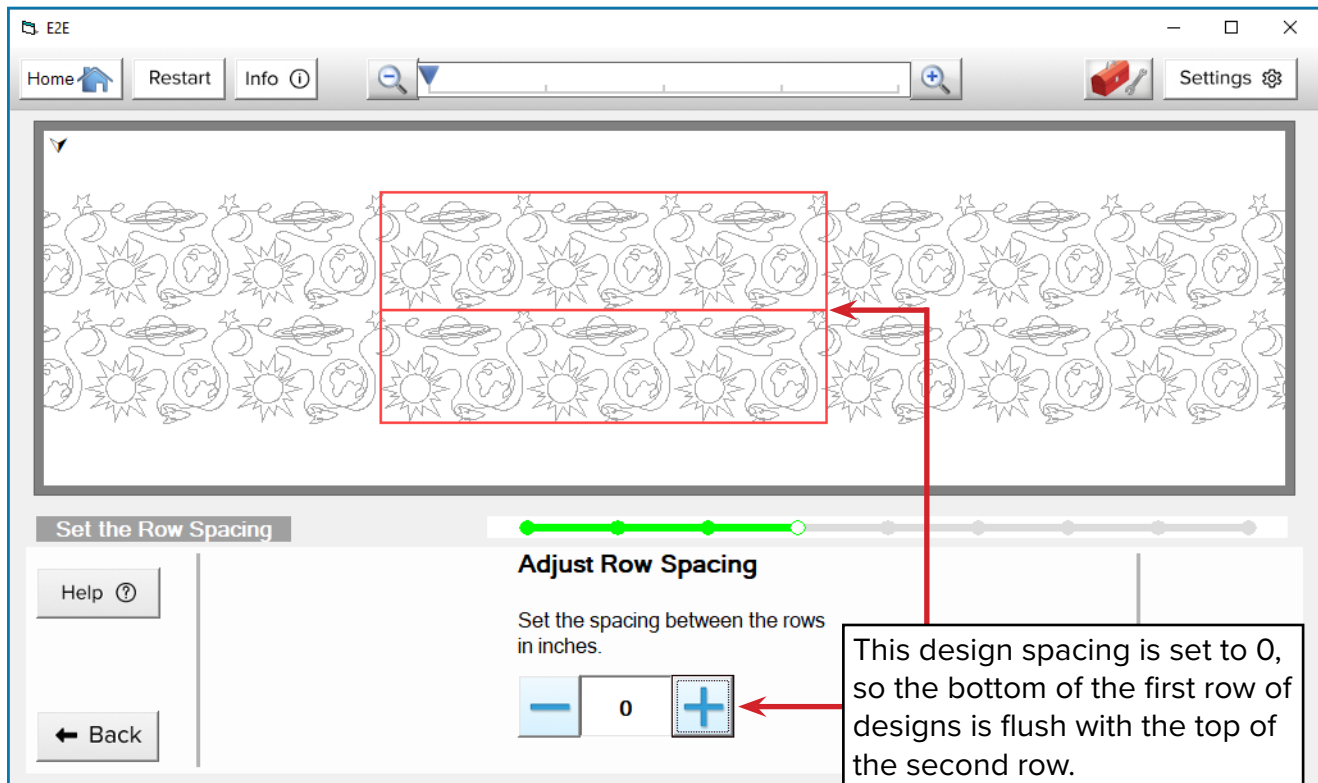

In the above example, even though the spacing is set to 0, the top and bottom rows of designs never cross over or intersect with each other. The designer built some space into the design.

Sometimes a lot of extra space is built into a design. When this happens, you may wish to **nest** your designs by changing how much space is between them so the top of the second row fills in the empty spaces in the first row.

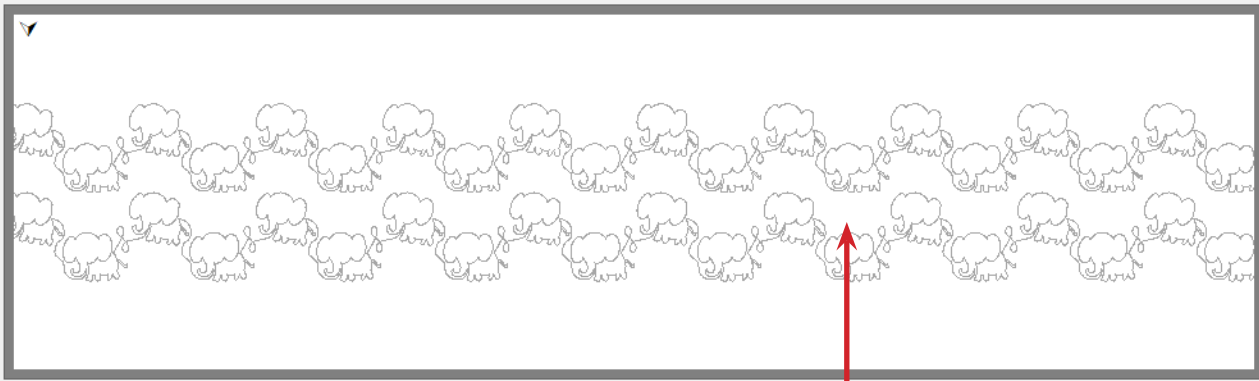

Set the Row Spacing

Adjust Row Spacing

Set the spacing between the rows in inches.

0

This design spacing is set to 0, but there are large gaps between the rows.

Help ?

← Back

Next →

VOCAB REVIEW

Nest: Alter the spacing between rows of designs so one row tucks into the empty spaces in another row.

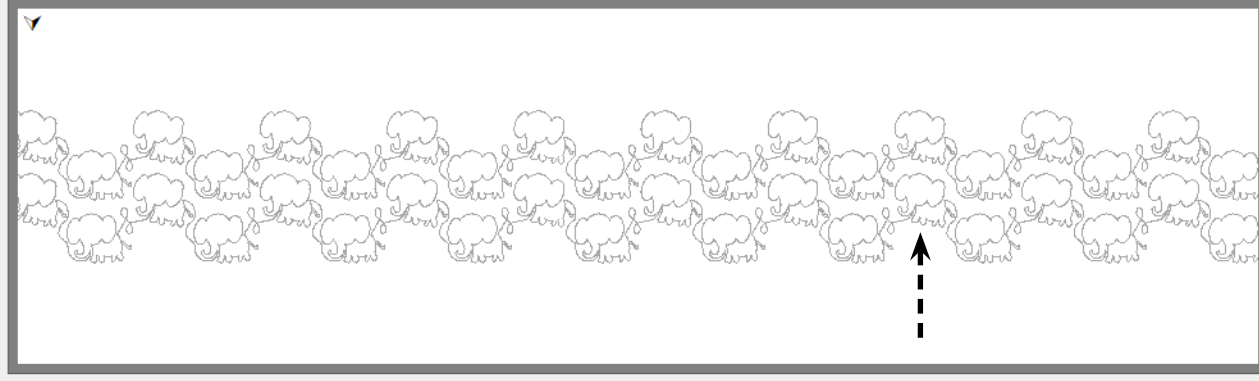

Set the Row Spacing

Adjust Row Spacing

Set the spacing between the rows in inches.

-7/8

This design spacing is set to -7/8 inches. The top of the second row was moved up almost an inch to fill the spaces in the previous row.

Help ?

← Back

PRACTICE STEPS

You will need:

- Project sticky notes (came with Quilter's Creative Touch 6)
- Pen or marker

- 1 Press the **Plus** and **Minus** buttons to play around with different spacing until you like the look of your rows. You can also tap the number to open the number entry box like the one you used in the previous lesson.

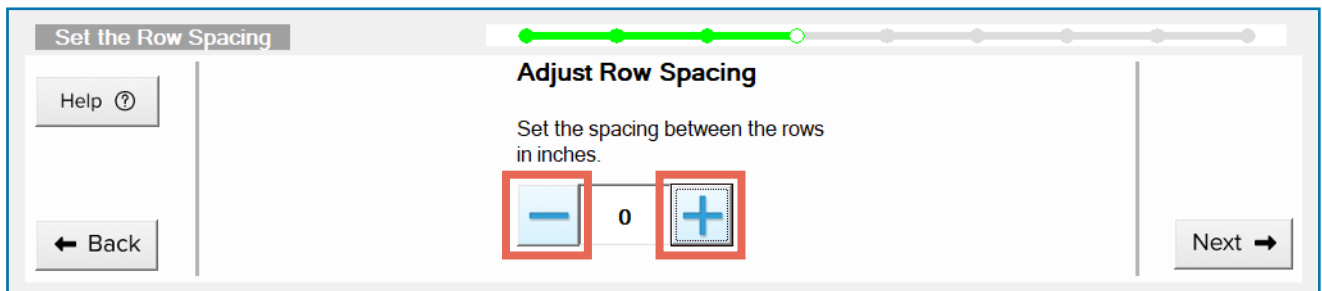

- 2 When you like the way your rows look, tap the **Info** button on the header bar.

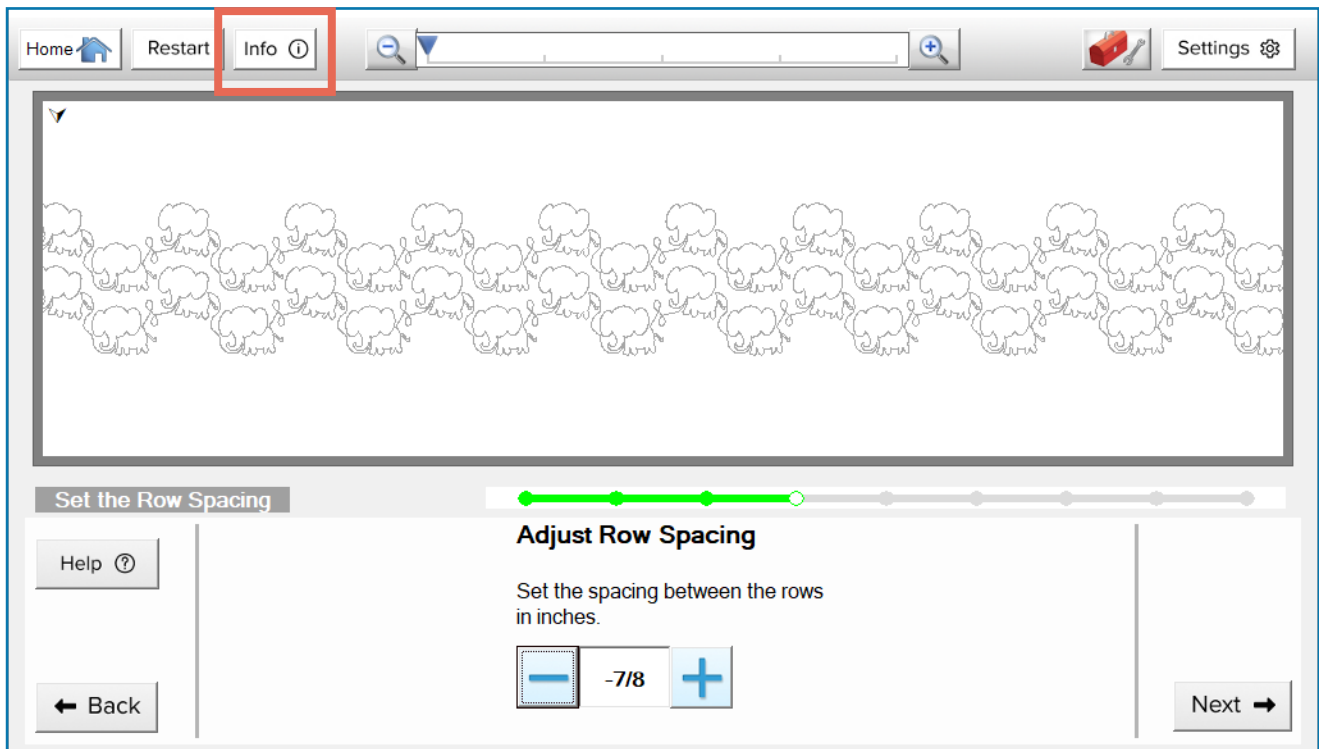

The Project Details open.

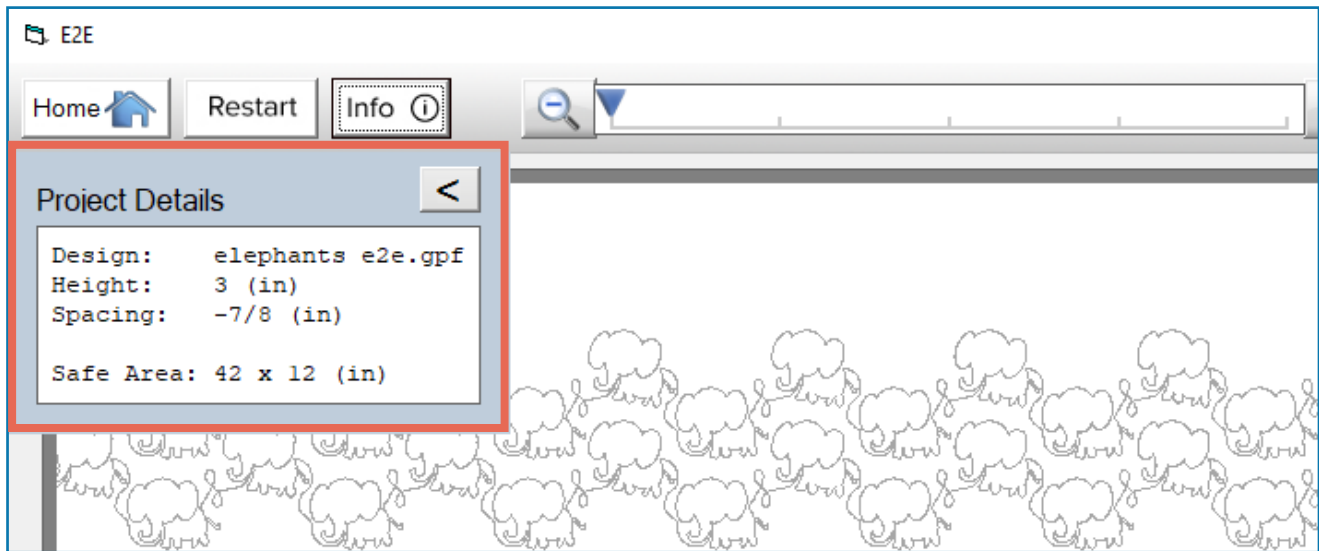

- 3 On the sticky notes that came with your kit, record your **Design file name**, **Height**, and **Spacing**.

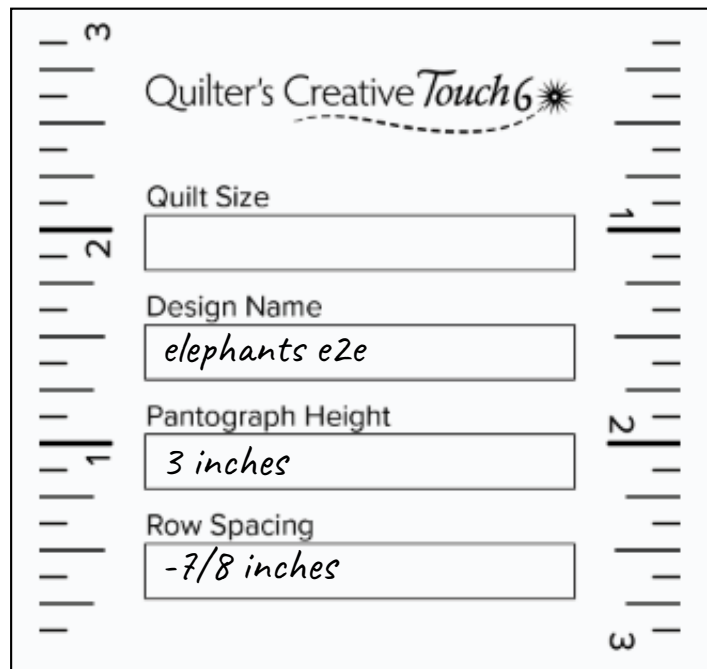

- 4 Always keep your sticky note close to your project. If your software shuts down unexpectedly or you have to take a break from quilting for a while, you will need this information to resume your project.

When ready to continue, close the Project Details and tap **Next**.

9

Lesson Nine: Selecting the Quilt-Top Edges

KEY CONCEPT

The edges of the quilt top are the edges of the (usually pieced) top layer of your quilt sandwich, and do not include the edges of the backing or batting.

Back in “Lesson 5: Setting the Safe Area,” you started to help the software map out a portion of your quilt sandwich on the frame. Now you’re going to fill in some of the details of that map by telling the software where the edges of your quilt top are. Remember, your quilt top is the top layer of your quilt sandwich. The batting and backing are the other two layers. On this screen, you are being asked which of your quilt top’s edges are currently within the safe area.

For example, in the image below, the top edge is rolled up onto the take-up rail. The bottom edge is draping off the frame, toward the floor. Only part of the left and right edges are within the safe area.

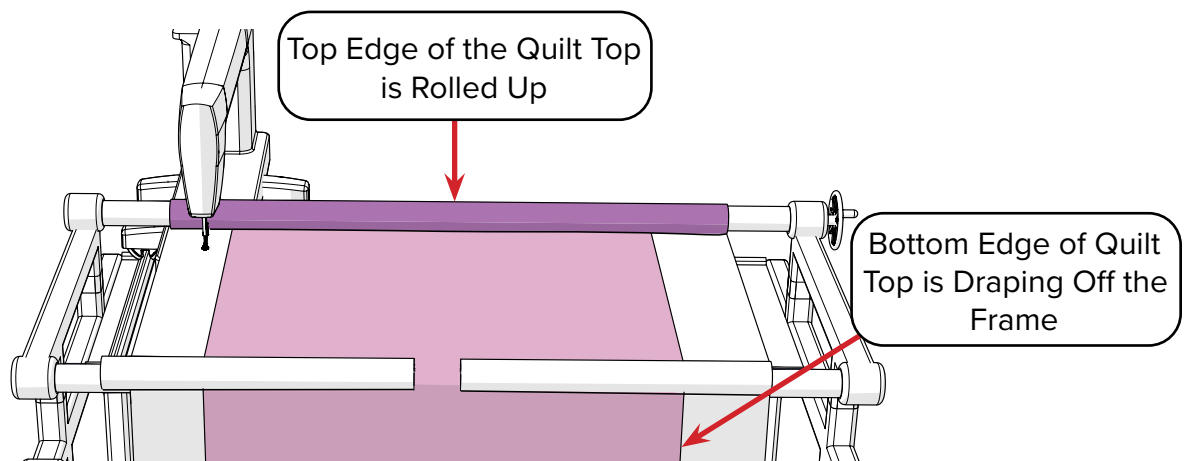

The left and right edges are the only edges currently in the frame’s safe area.

The buttons correspond with the edges that are on the frame. Imagine that the white box in each button represents a part of your quilt top on the frame. The red borders represent the batting around the quilt top. In the example above, only part of the side edges are in the safe area. So, the **side edges only** button is the correct choice from the options on the screen.

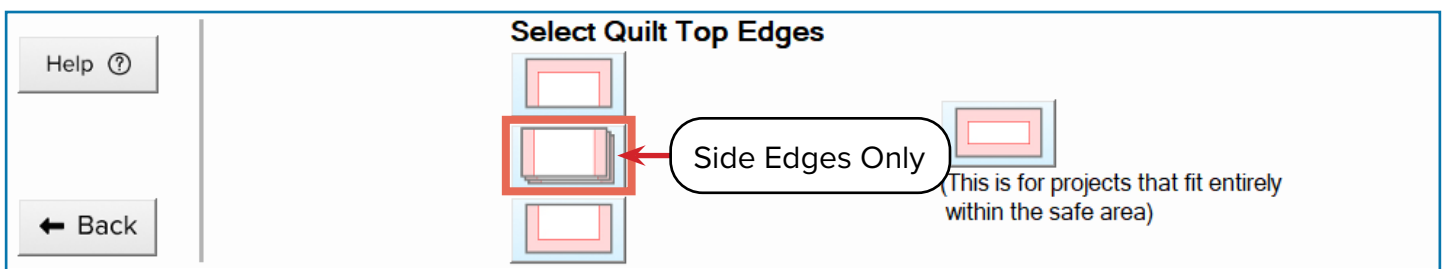

WHY DOES IT MATTER WHERE MY QUILT-TOP EDGES ARE?

Soon you will be placing your design. This is the process of using the machine needle to point to the location on the quilt top that you want the machine to stitch out the design. The software uses slightly different placement methods depending on where you're at on the quilt, and it uses the fabric edges you enter to determine where you're at.

PRACTICE STEPS

- 1 Look at your quilt top. Which edges of the quilt top are within the safe area?

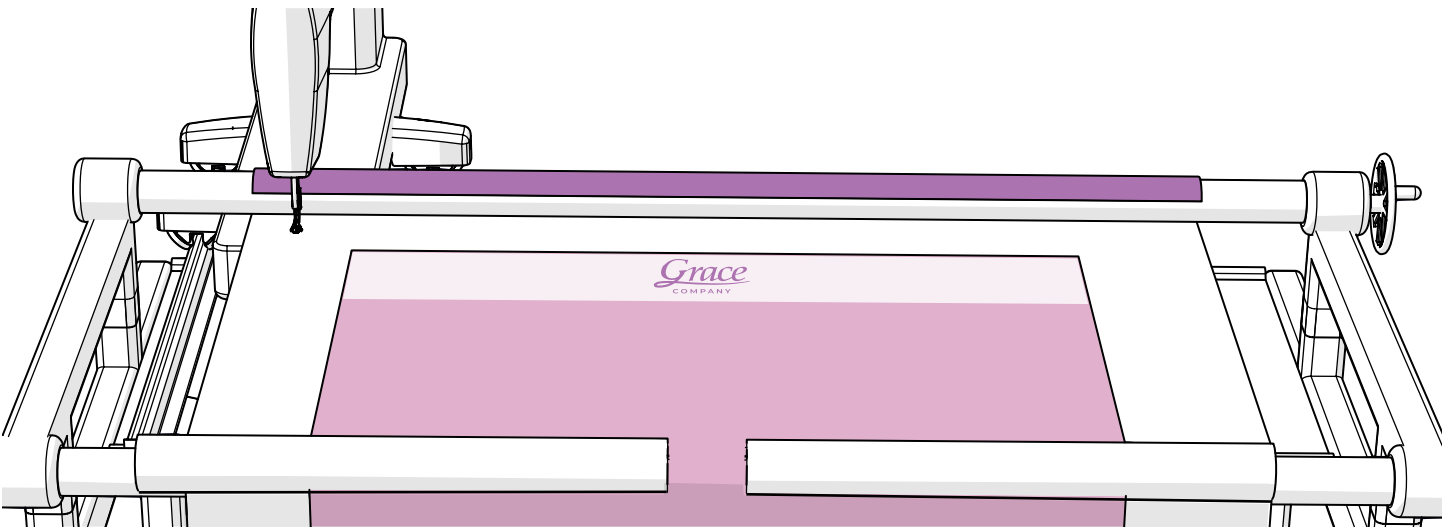

- 2 Tap the button that corresponds to the edges currently in the frame. If you're following along with this booklet using the panel, select the **top-and-sides** button.

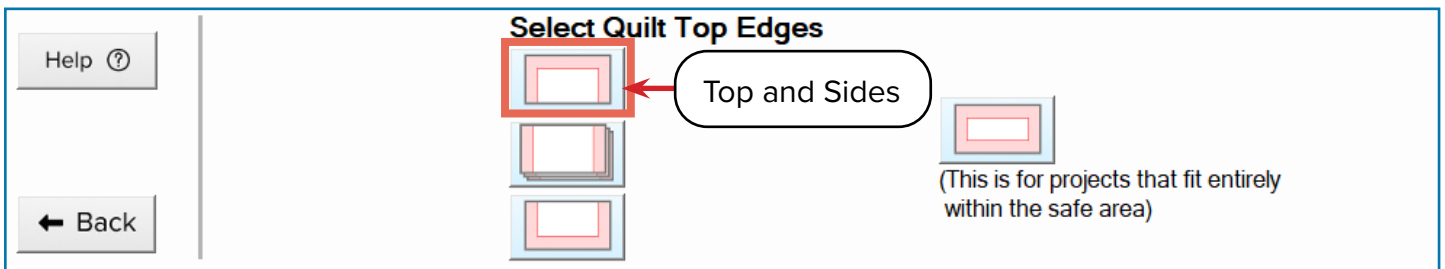

10

Lesson Ten: Setting the Quilt-Top Edges

KEY CONCEPT

Use the machine needle to point out where the quilt-top edges are on the frame.

In the previous lesson, you told the software what part of your quilt you're working on. Now it's time to show the software exactly where the quilt top edges are. This may feel repetitive at first, but it will help you in a few minutes when you're placing your first row of designs.

You've already used the machine needle as a pointer when you set your safe area. Now you'll be using it to point to the edges of the quilt top. You will move the machine needle over a point along your quilt top edge (such as the top-left corner) and tap the corresponding **node** on the screen. The nodes are the gray circles and they turn green when they are activated.

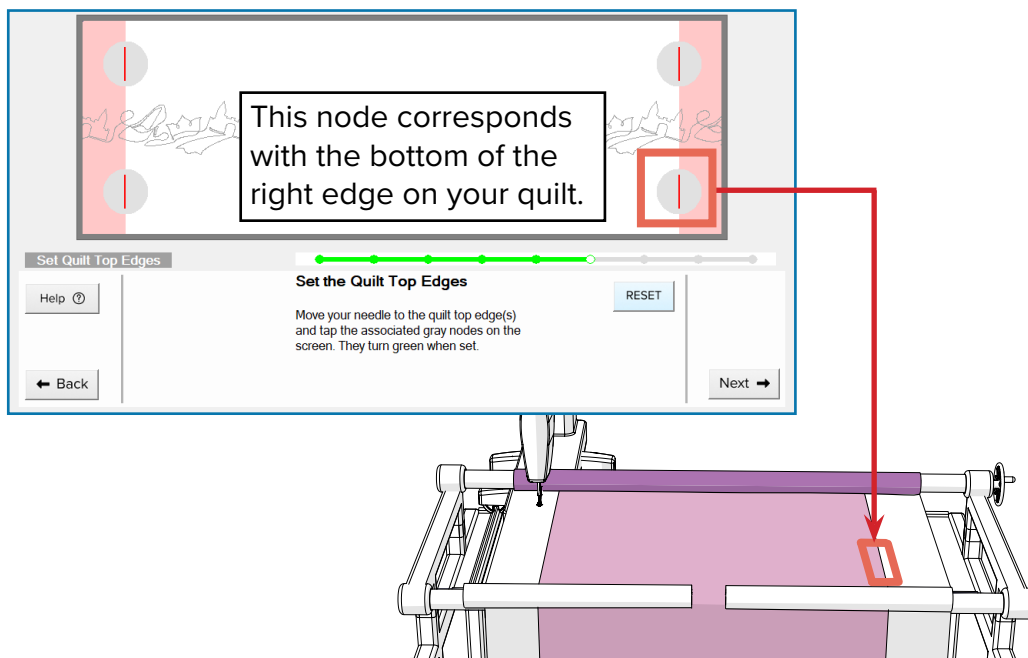

PRACTICE STEPS

- 1 Look at the nodes (gray circles) in the preview window on the screen. Nodes in the corner correspond with that specific corner of the quilt top. Once again, the red strips represent the batting.



- 2 Move your machine so the needle is hovering over the corresponding edge of the quilt-top. If you're following along with your panel, place your needle directly over the top-left corner.

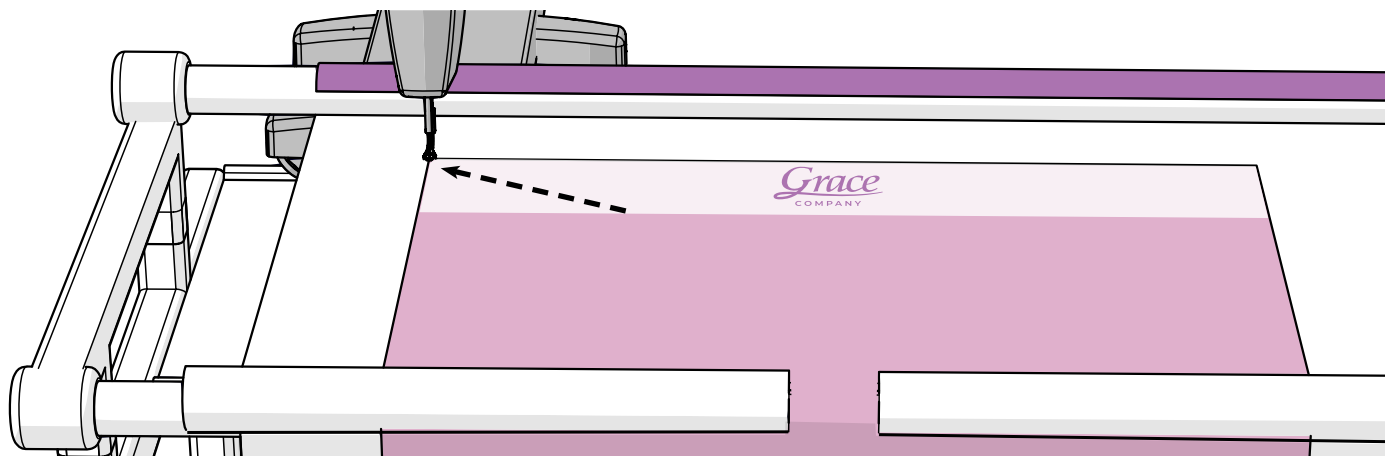

- 3 Tap the corresponding node on the screen so it turns green.

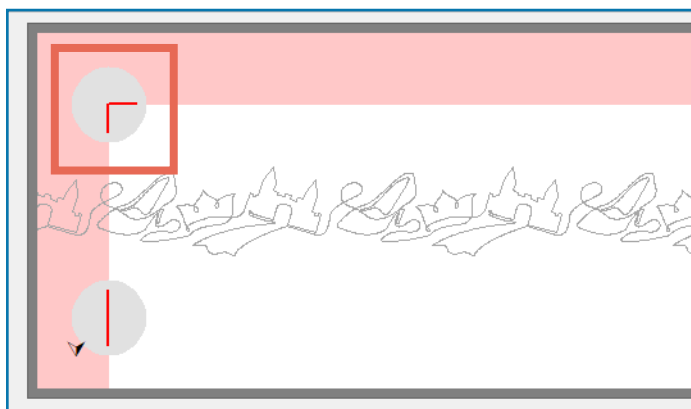

- 4 Slide the machine forward and align the needle with the left edge. Tap the corresponding node.

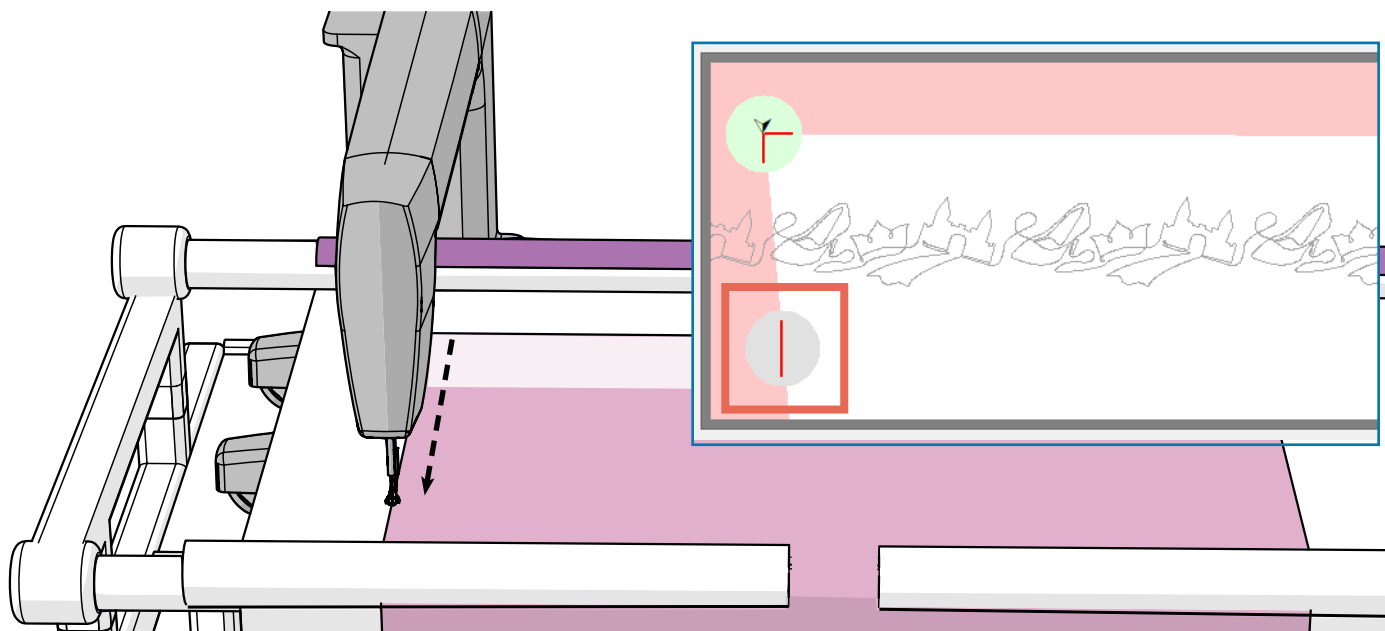

- 5 Slide the machine to the other side of the frame and align the needle with the top edge and tap the corresponding node.

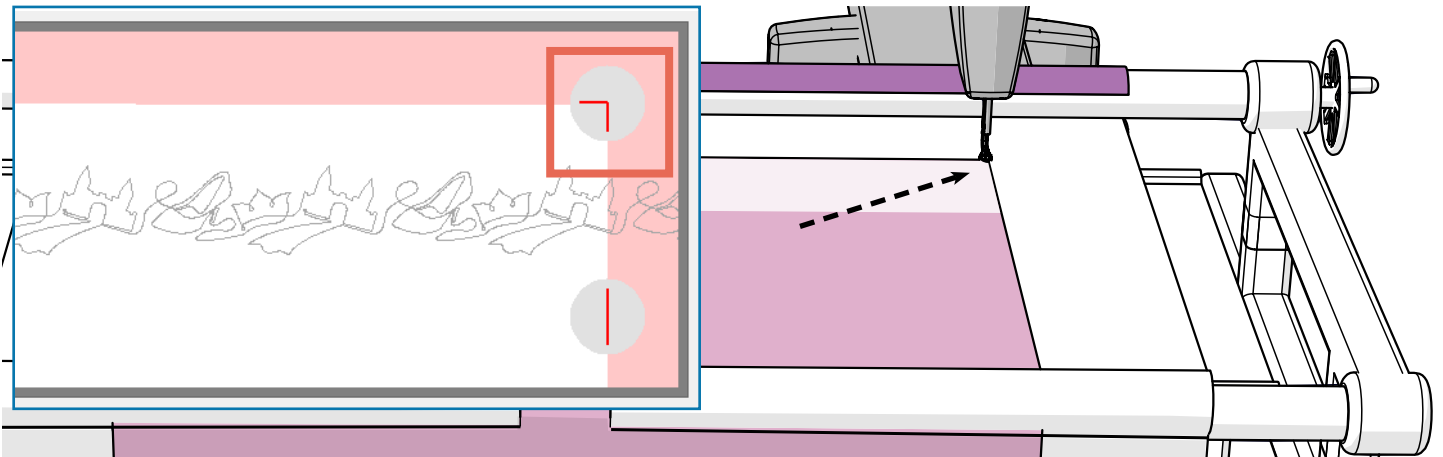

Note: Do not worry if the edges of your quilt top on the screen don't look perfectly square. They can appear quite crooked without causing any problems. This is because it is very difficult to install a quilt onto a frame so that the quilt top edges are perfectly square with the frame, and any slant in the fabric on the frame must be reflected in the software.

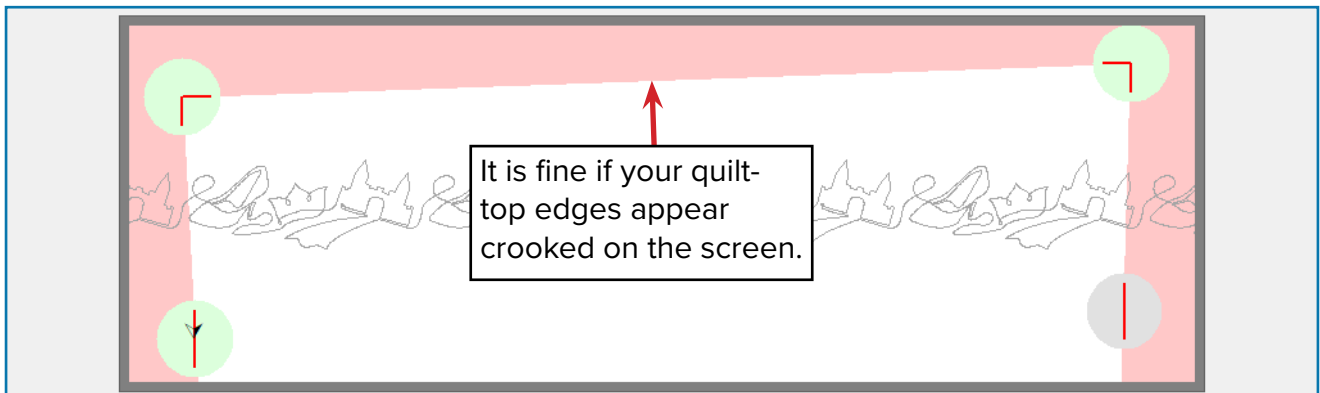

- 6 Pull the machine forward and align it with the right edge. Tap the remaining node on the screen.

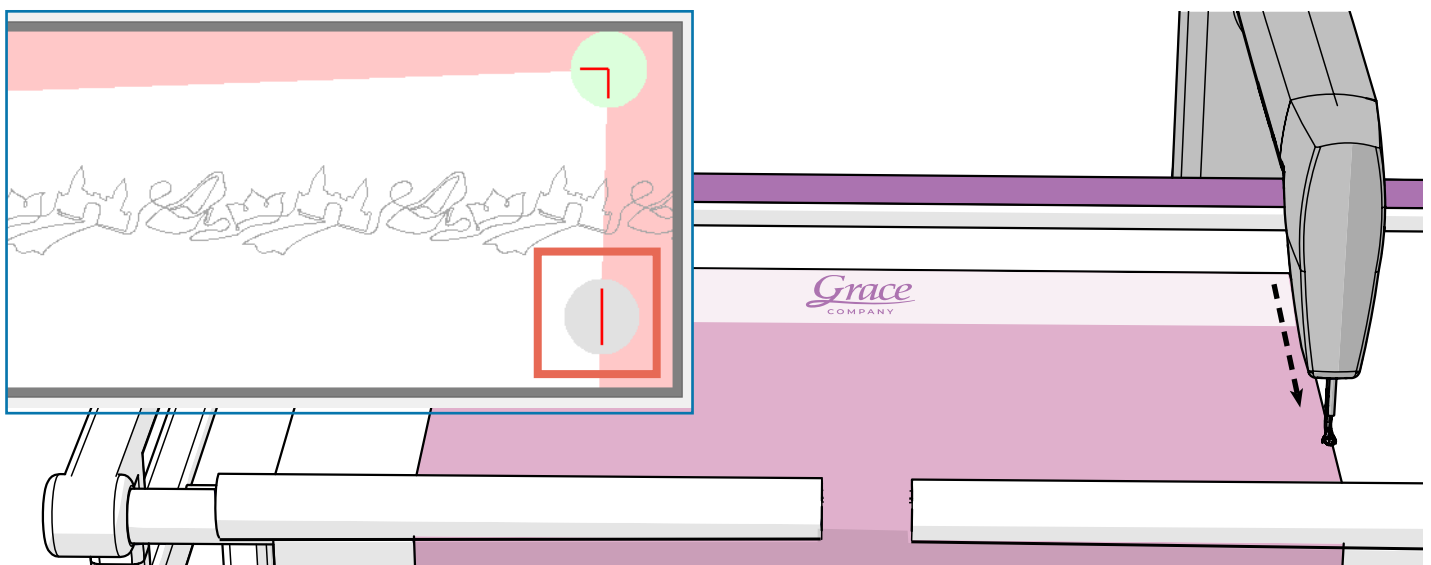

TROUBLESHOOTING

If the red edges disappear in the preview window after you set them in this step, you might have set the safe area too close to the quilt-top edges. Tap **Back** on the screen until you return to the first safe area screen. If setting your safe area according to the instructions in this book does not solve the problem, your fabric needs to be repositioned so the quilt is centered on the frame and the top edge is further from the take-up rail.

- 7 Once all the fabric edges are set (all the nodes are green), tap **Next**.

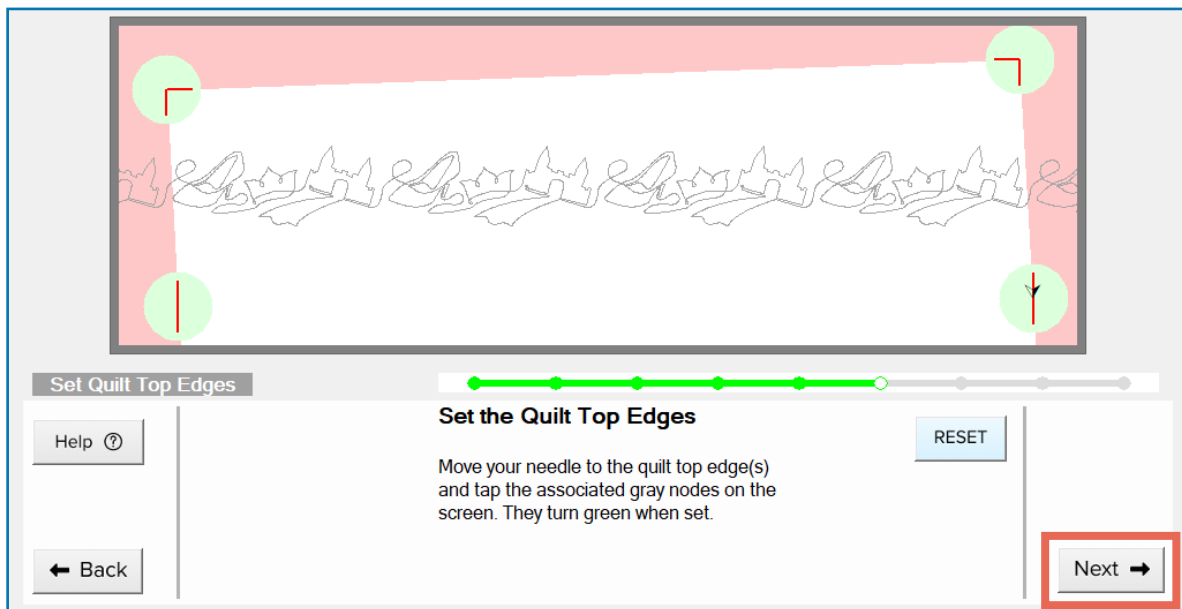

11

Lesson Eleven: Marking Your Placements

KEY CONCEPT

For even coverage, your design is automatically placed off the quilt-top edges, but you'll need to mark the placement locations.

Imagine that you printed out your row of designs on a strip of paper so that the edges of the paper act as a rectangular border around your design. In the software, the top left and top right corners of this border are "placed" on the quilt so that the sewing machine knows where to stitch.



The software has placed your design on an ideal spot on your quilt for edge-to-edge quilting. This means that the top corners of the design have been anchored to locations on your quilt sandwich and the design will be stitched out between these locations.

Design Corner

Design Corner

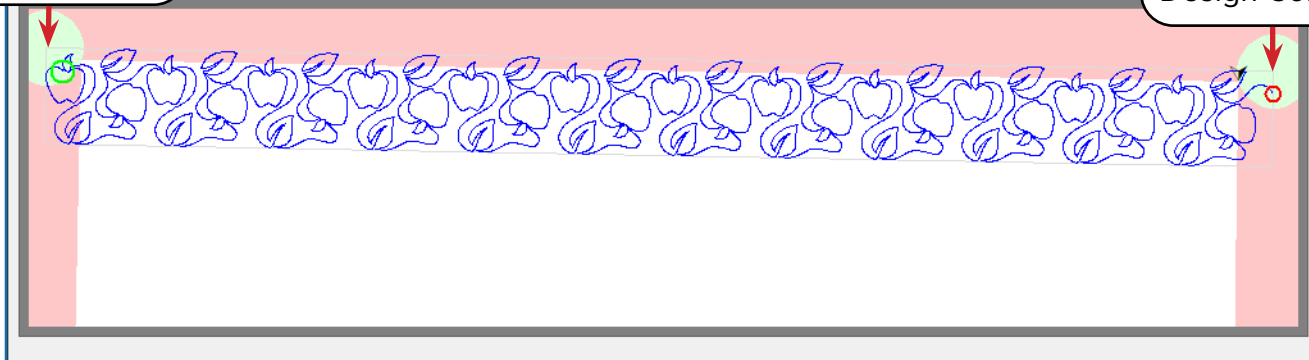

Notice that in the preview window, some of the design is falling onto the batting (the red strips). This might seem like sloppy placement, but this is exactly what you want for a nice, neat appearance across the entire quilt. It's called "quilting off the quilt-top edges." This is ideal placement because it prevents odd gaps in the quilting that could have been filled with more design lines.



Poorly-placed designs leave odd gaps around the edges of the quilt.

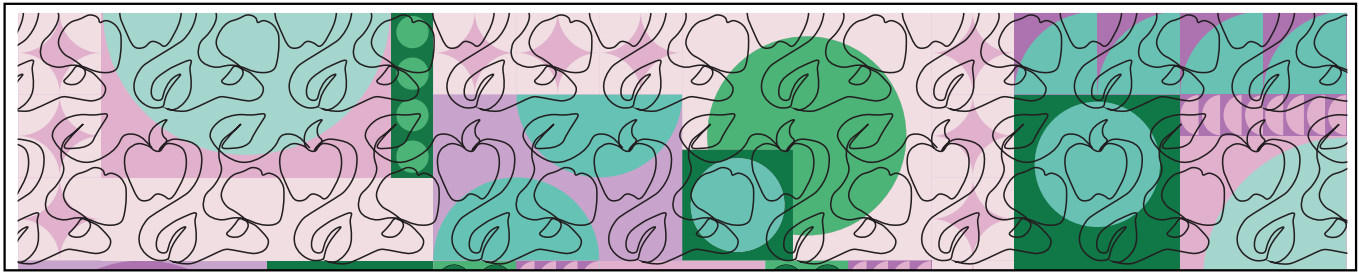

Designs placed off the quilt-top edges evenly cover the entire quilt top.

The software cleverly positions your design so that you do not need to worry about these gaps (or other basic design placement problems), but as you grow more experienced in quilting, you can experiment with placing things manually if you like.

For now, let's trust the software's placement choice and mark the placement locations on the quilt. You always want to mark your placement points because you never know if you'll need to go back and place the design again later if something goes wrong in the quilting. You're also prompted later on to mark after each row stitches out. Those marks will be used to place your next row of designs. Take the following steps to mark the placement locations for your design on your quilt.

IMPORTANT: During the practice steps in this lesson the automation will engage and move the machine across the frame. Whenever the machine moves on its own, a STOP button appears on screen. If there is an emergency (such as the needle is down and begins to pull the fabric) press STOP to halt the machine.



This button appears when automation moves the machine. If needed, press to halt the machine.

PRACTICE STEPS

You will need:

- Marking Stickers (came with Quilter's Creative Touch 6)
- Two pins

- 1 On the screen, tap the button that says **Move Left**. The machine needle moves to the point on your quilt that corresponds with the top-left corner of the design.



- 2 Place a **sticker** on the quilt, under the hopping foot and needle.

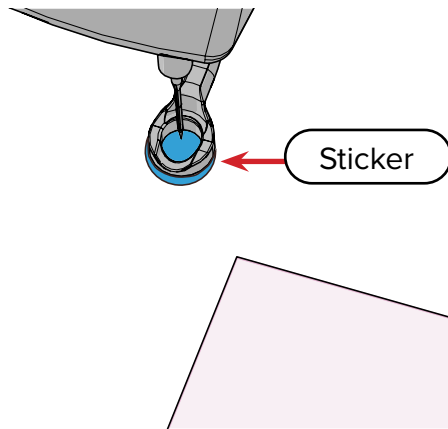

- 3 Tap **Single Stitch** to puncture the sticker. The hole in the sticker is the exact placement point for the top-left corner of the design.

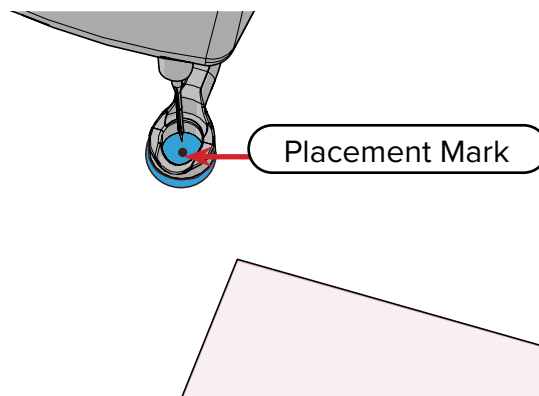

- 4 Now move your machine over to the right side of the frame and tap **Move Right**. The machine needle moves over the right placement point.

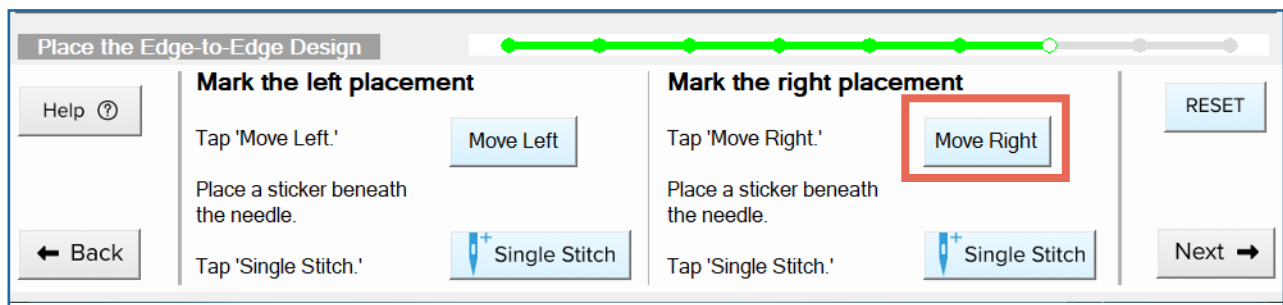

- 5 Place another **sticker** under the hopping foot and use the **Single Stitch** button to puncture it.

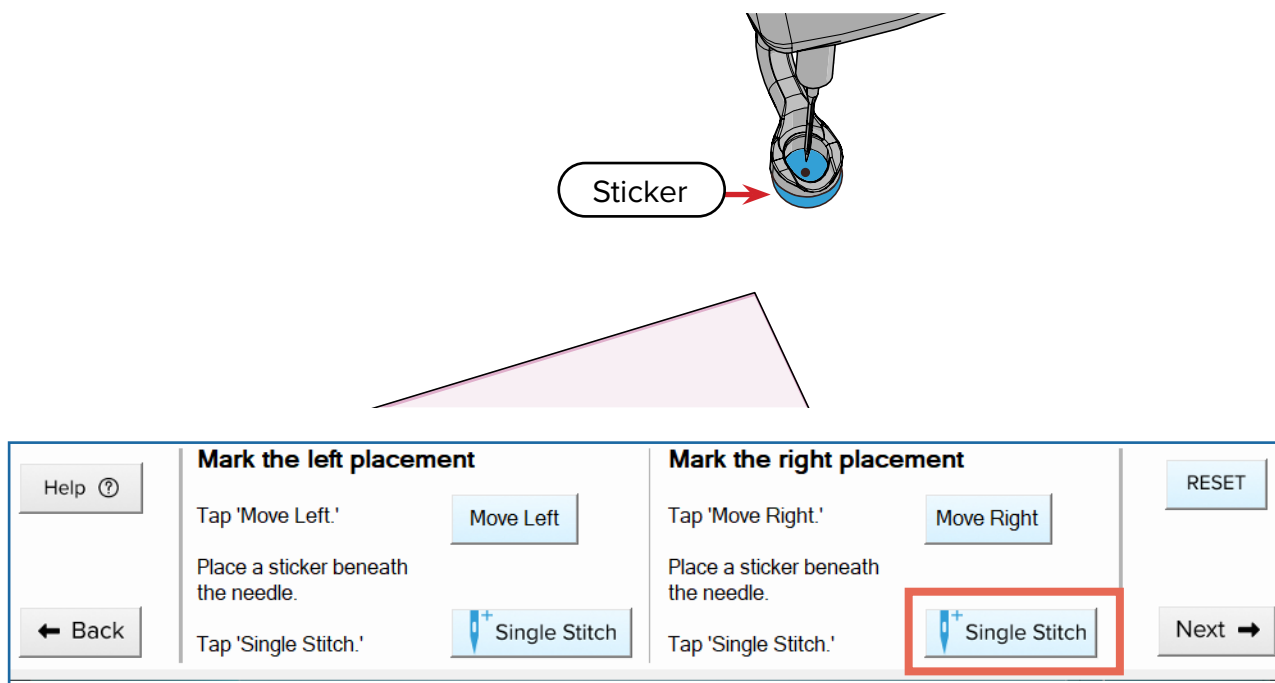

- 6 If you're concerned that your sticker might fall off, use a pin to secure it to the batting. Pin down through the **puncture mark** in the sticker and back up through the batting. Do not puncture the sticker a second time. If you do, it might cause confusion later when you remove the pin and there are two holes.

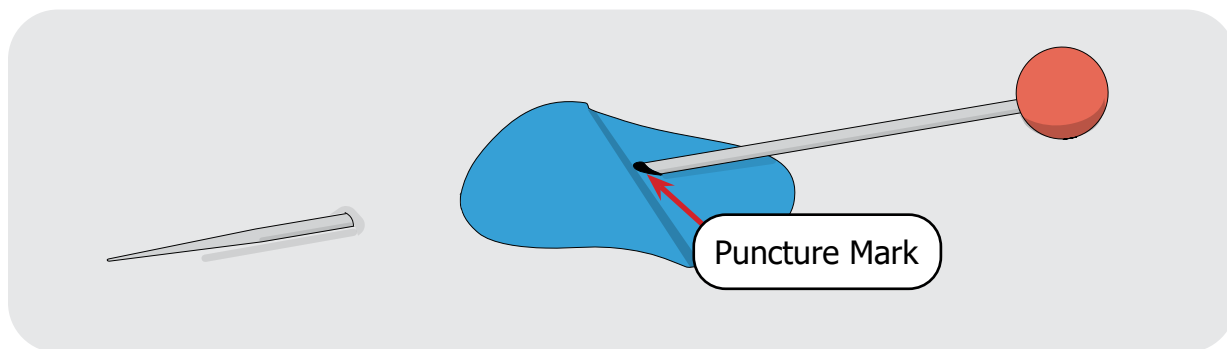

- 7 When both marks are placed, tap **Next**.

EXTRA CREDIT

You might have noticed the “reset” button on the right side of the screen. This button will reset the design's placement to the default position. This will make more sense when you learn more about manually placing designs later in this booklet.

12

Lesson Twelve: Pulling the Bobbin (start)

KEY CONCEPT

Pulling the bobbin can be done manually or with the help of the software. Practice both!

In “Lesson Two: Tacking Down Your Edges,” you learned how to manually pull your bobbin thread. The Pull Bobbin Thread (start) screen helps you achieve the same results but with a little help from the software. It might feel intimidating to try to pull your bobbin manually because you do not know where to place the first stitch. Follow the instructions in this lesson and the machine will move the needle to the starting point for you.

After quilting for a while, you might find that you can reasonably guess close enough to the first stitch location to pull the bobbin yourself, without needing the software’s help. If you decide you want to skip this step of the software, you can turn pull bobbin steps off in the Settings.

PRACTICE STEPS

- 1 Hold the top thread tail and tap **Starting Stitch**. The machine moves to the starting point of the design and does a single stitch.

Tip: Before tapping **Single Stitch**, move your machine to the left side of the frame. The closer the needle is to the actual starting point of the design, the less time you have wait for your machine to move.

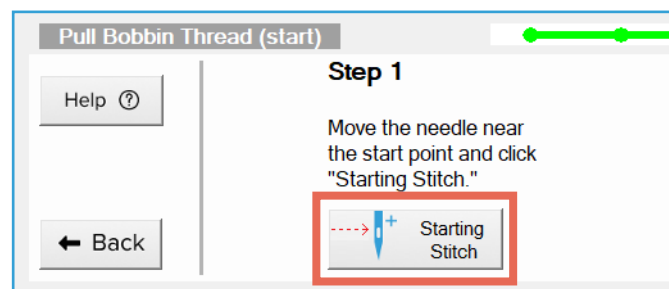
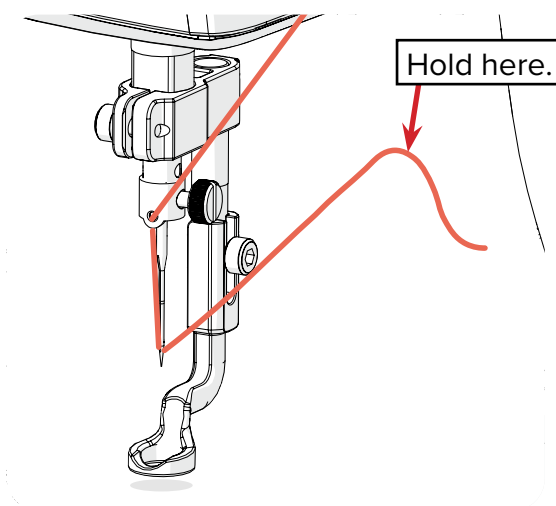

IMPORTANT: The machine moves when you press Starting Stitch on this screen.

Note: After pressing **Starting Stitch**, a message might appear saying that the machine is about to move. Continue to hold the thread and press **OK** on the screen.

- 2 Still holding the thread tail, move your machine needle away from the starting stitch. A loop of bobbin thread is pulled to the top. Keep pulling until the bobbin tail is pulled up completely.

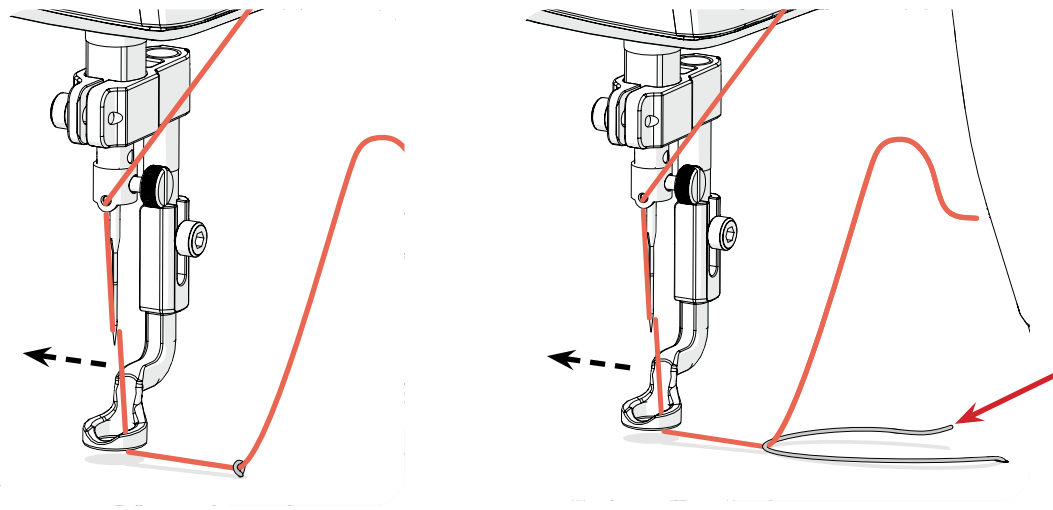

- 3 Move the machine back to the first stitch. Lay the two thread tails out of the way (onto the batting, if possible). You don't want automation to stitch over the tails accidentally.

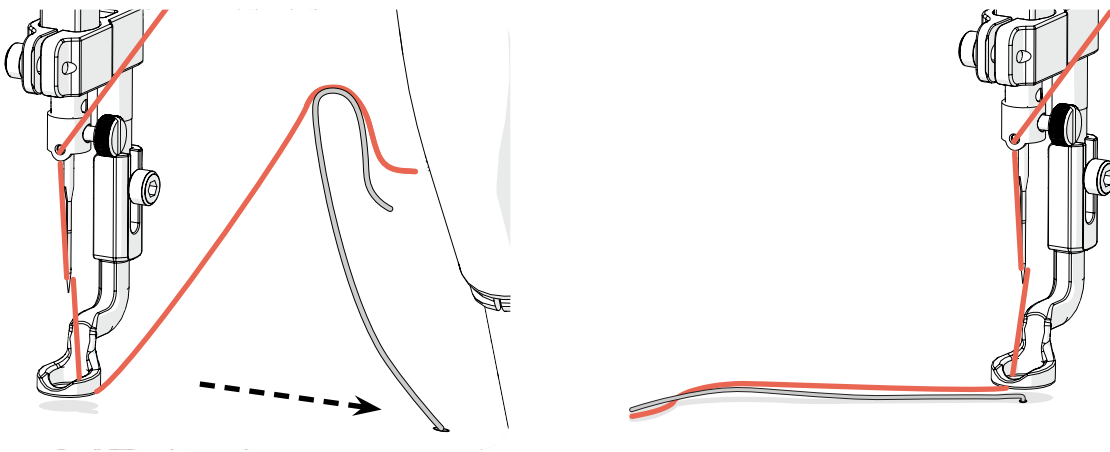

- 4 Tap **Next** to proceed.

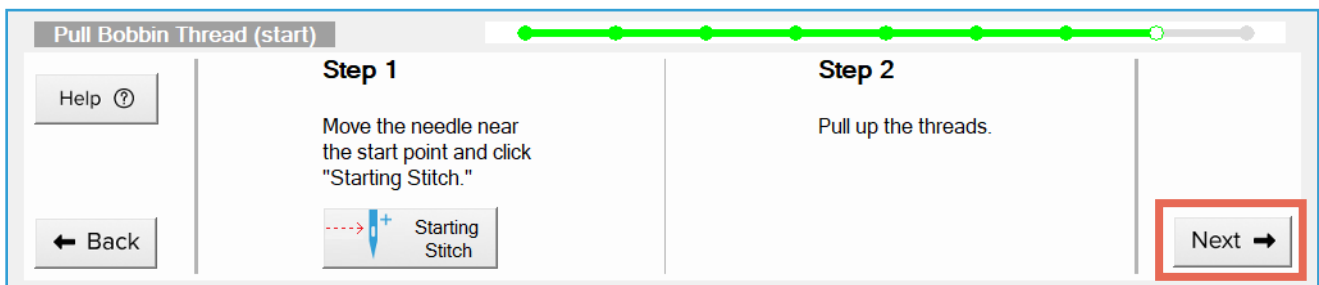

13

Lesson Thirteen: Edge-to-Edge Quilting

KEY CONCEPT

The preview window in the E2E Start Stitching screen shows what the design will look like when it's stitched out, including how the design is clipped along the quilt-top edges.

Before you press the big green Sew button, there are a few things to do in the E2E Start Stitching screen.

The preview window of the E2E Start Stitching screen shows a to-scale depiction of how the design will look when it is stitched out. If there are 10 repetitions on the screen there will be 10 on your quilt top when the machine is finished stitching.

You might notice that your design looks different than before. This is a good thing. The part of the design that fell into the red edges during the placement step are now missing, replaced by flat lines that follow along the edge of the fabric. This is because the software has clipped the design to save the thread that would normally be wasted stitching out past the fabric onto the batting. You will have the advantages of having a design that was placed off the edges of the quilt without the wasted thread (and time) that comes from actually sewing off the edges.

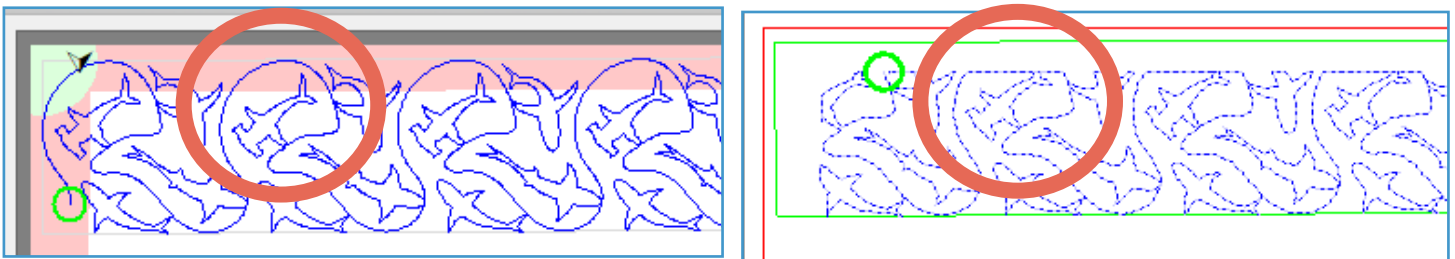

The portion of the design that would normally stitch into the batting is clipped from the sewing path.

The starting stitch (or first stitch) of the design is indicated by a green circle on the screen. The ending of the design (the last stitch) is indicated by a red circle. When the design is clipped, it's normal for the first stitch and last stitch end up in different places.

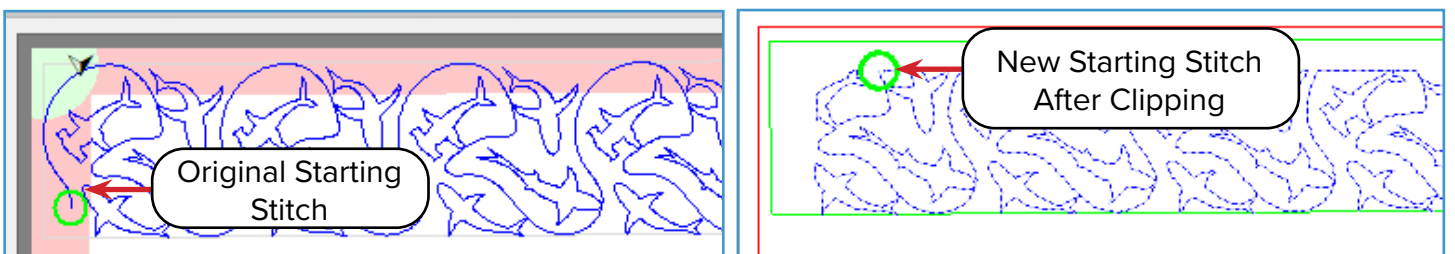

PRACTICE STEPS

- 1 Check your design to make sure it looks correct. You're unlikely to see problems with your first row, but it's best to get in the habit of looking over the design in this screen anyway.
For example, imagine that you accidentally set edges around your quilt even when working in a zone that didn't have edges there. This could cause the design to clip the way it's supposed to along the edges, but it would be doing this in the middle of your quilt rather than at the edge. Not very pretty!
- 2 Tap **Settings** at the top of the screen to open the Stitch Settings.

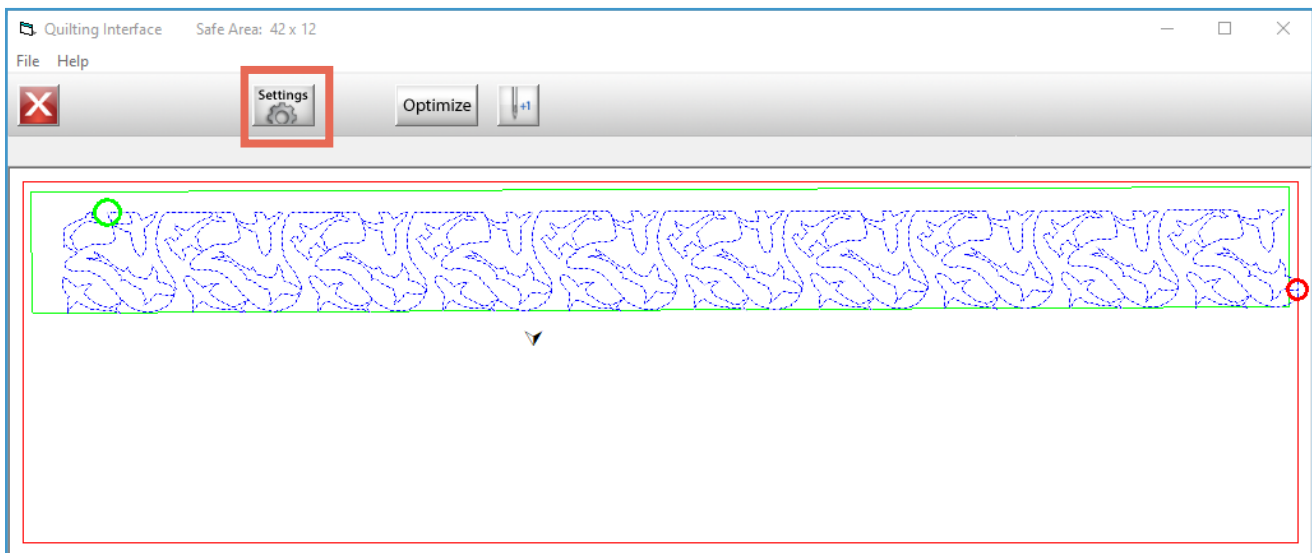

- 3 Review your **Stitches Per Inch** (SPI) setting. Quilting is typically done at an SPI range of 9–13. Geometric designs, with lots of points and corners, look better with a lower SPI (10–11) while an SPI of 12–13 works especially well with curved designs.

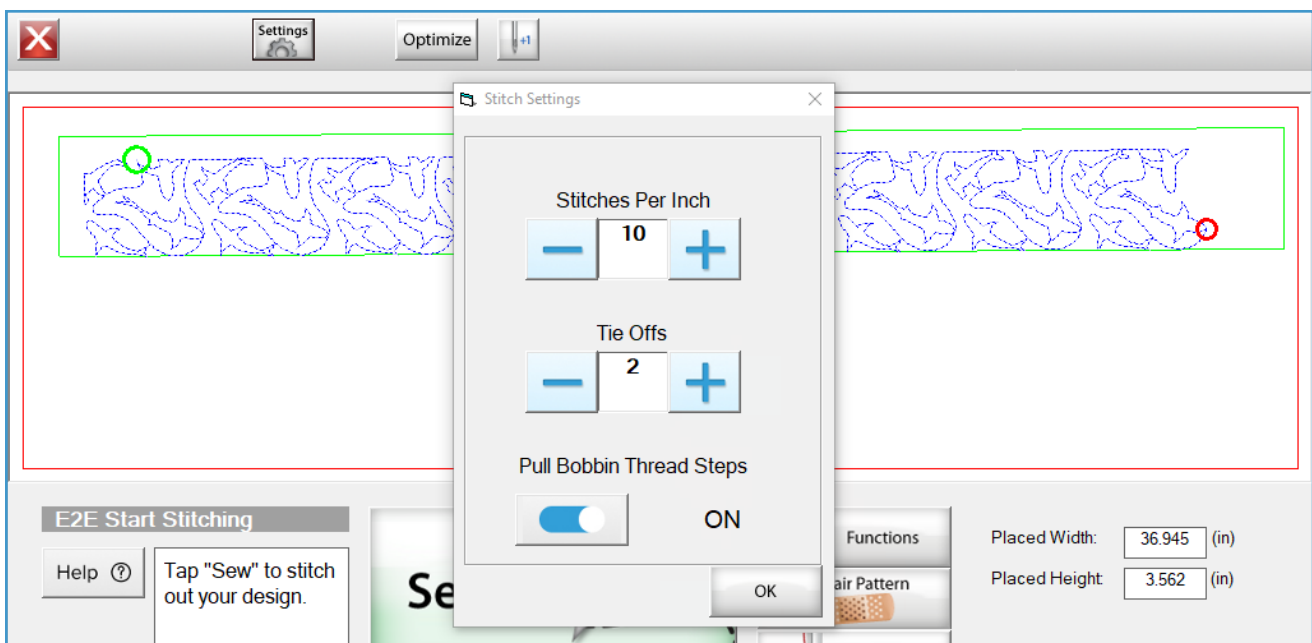

- Also confirm that you like the number of **Tie Offs**. This is the number of stitches the machine will make back-and-forth at the start and end of sewing to secure the stitching.
- When you're satisfied with your settings and how your design looks, press **Sew**. Be ready to move the top and bottom thread tails (and any pins) out of the way if the machine starts to sew toward them.

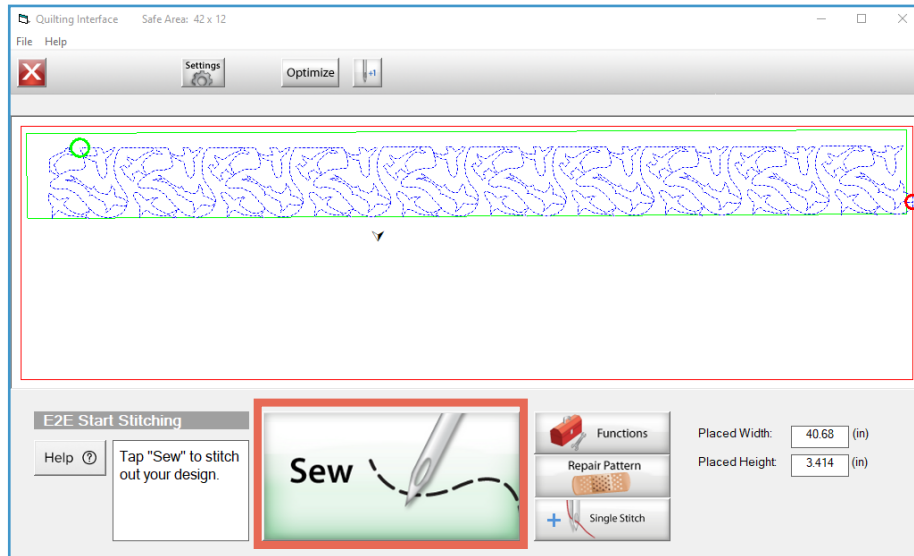

- The machine makes a tie off and begins to sew. After the needle is well away from the first stitch, trim the thread tails. If preferred, you can wait to trim the tails at the end of stitching.
- When stitching is finished, the **E2E Finished** screen appears. Congratulations! You've stitched out your first edge-to-edge design with QCT6!

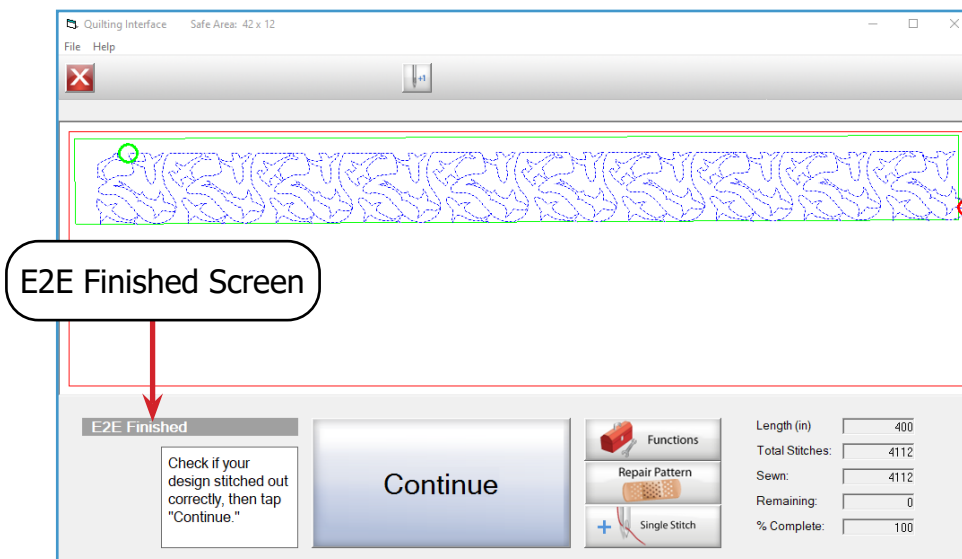

- 8 Check over the row of stitching (especially on the back of the quilt) to make sure the design stitched out completely and correctly.
- 9 Press **Continue** after you've confirmed your row looks good.

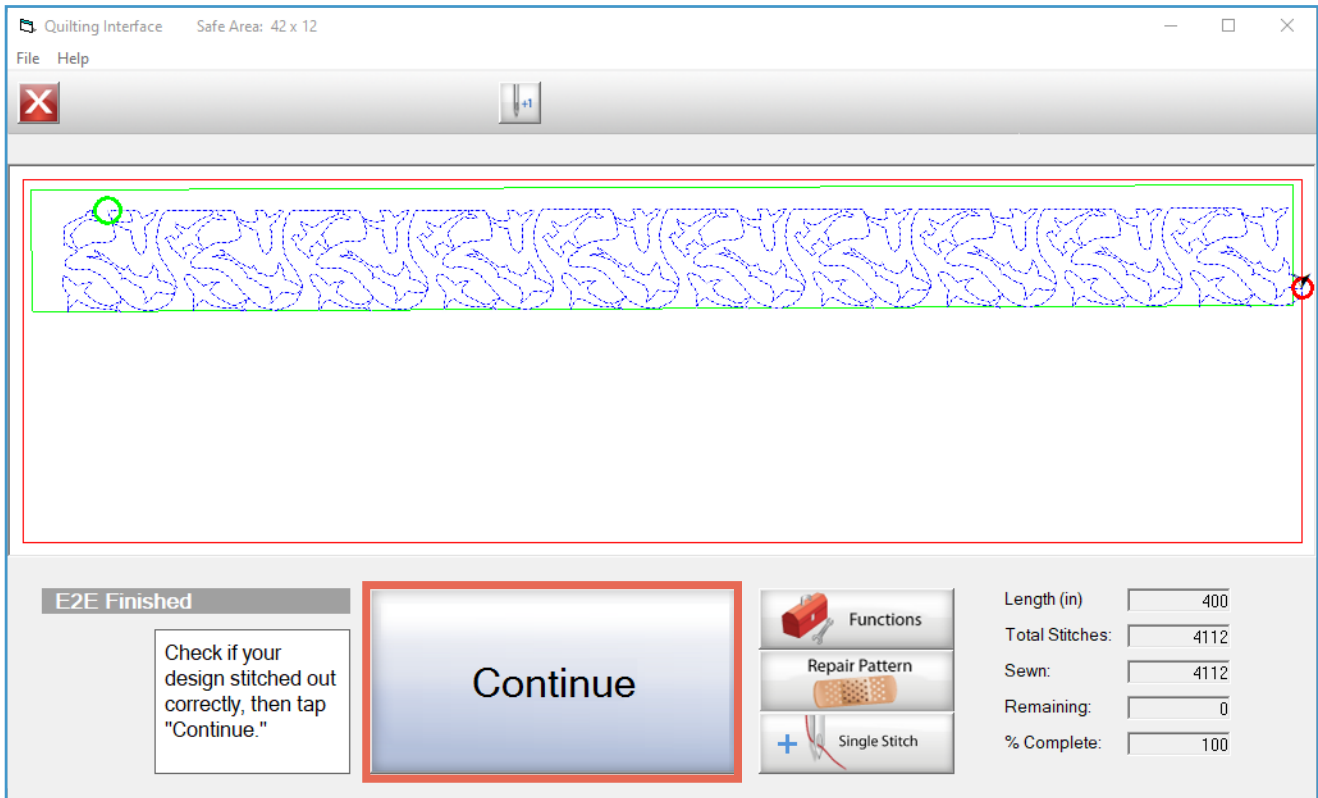

TROUBLESHOOTING

If you run out of bobbin thread during the middle of quilting a row (or something else went wrong with your design), check out “Lesson Eighteen: Repairing Your Design” on page 58. It will get you back on track.

GETTING TIRED?

If you'd like to take a break from quilting, follow the steps in “Lesson Nineteen: Taking a Break” on page 63.

14

Lesson Fourteen: Pulling the Bobbin (end)

KEY CONCEPT

Pulling the bobbin can be done manually or with the help of the software. Practice both!

This screen allows you to pull up your bobbin thread at the end of your row of stitching by giving you a single-stitch button. This time there is no automatic movement of the machine, and you will take all the same steps that you took before when pulling the bobbin at the end of tacking the quilt top down.

PRACTICE STEPS

- 1 Complete the steps for pulling the bobbin at the end on page 13. However, when you get to step C, use the single-stitch button on-screen to perform a single stitch.

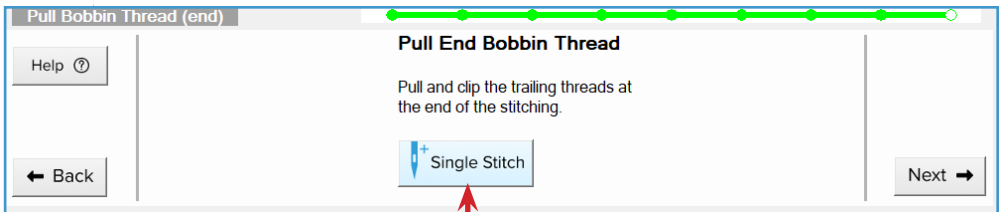
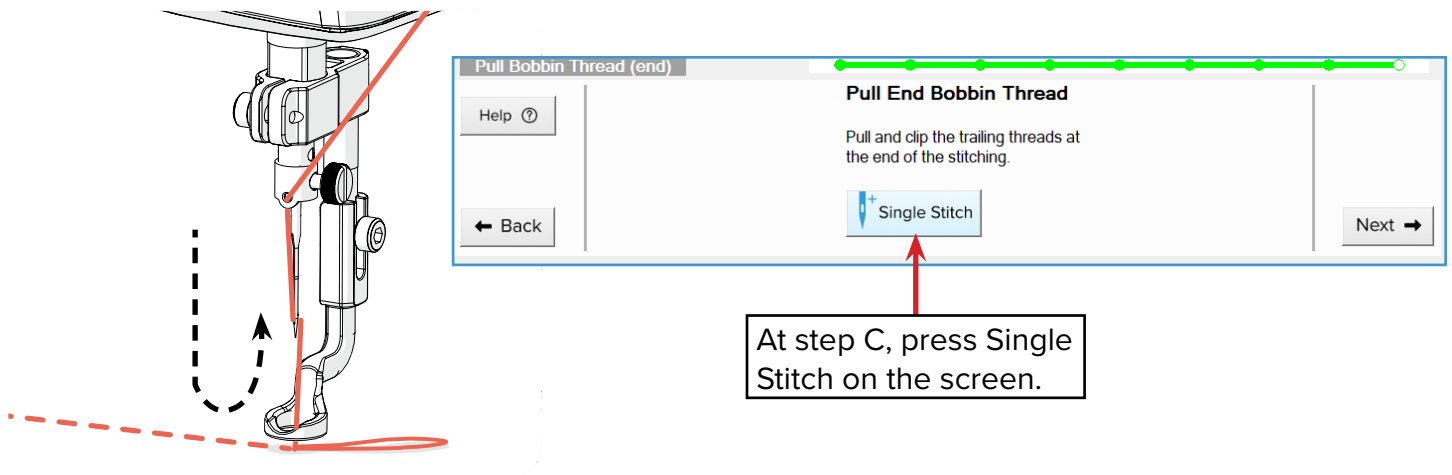

At step C, press Single Stitch on the screen.

- 2 After you've pulled up your bobbin and cut the threads, tap **Next**.

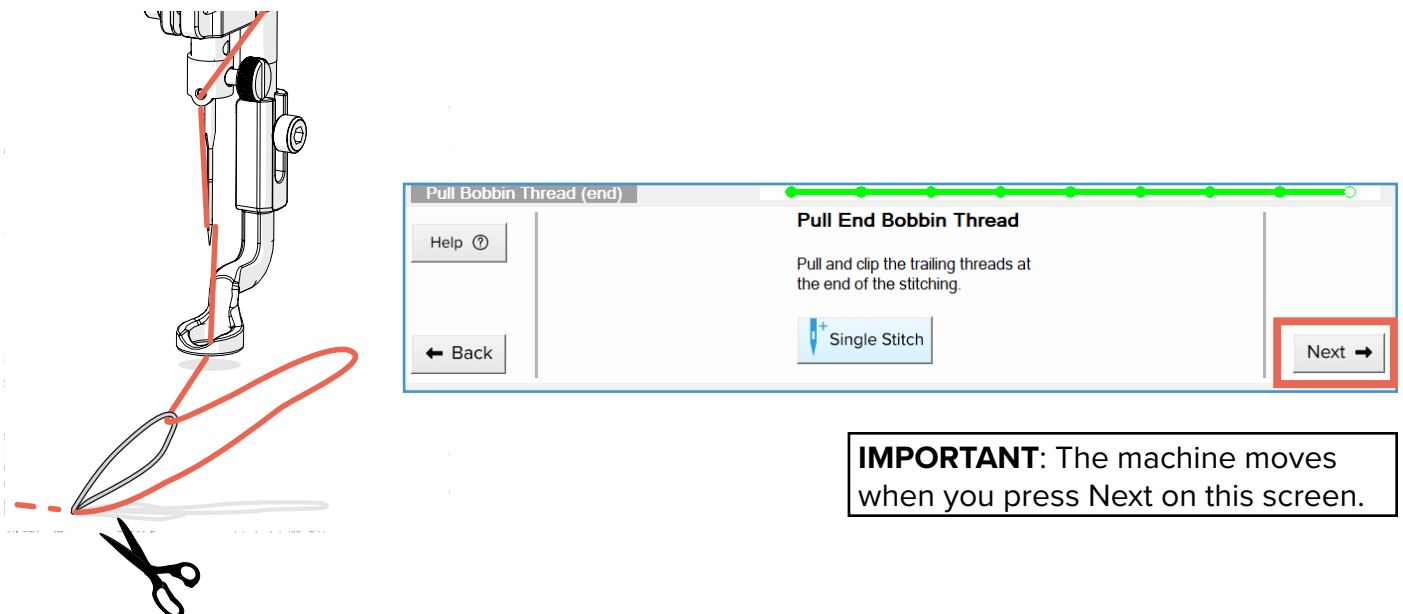

IMPORTANT: The machine moves when you press Next on this screen.

15

Lesson Fifteen: Marking Your Next Row

KEY CONCEPT

Marking your rows out before you place them keeps things neat when it's time to shift fabric or return to quilting from a break or shut down.

The software uses the spacing and design height information from earlier to determine where to stitch out the next row underneath the one you just sewed. In this task, you will mark your quilt where the software directs you to mark. Later, you will use these marks to place your next row.

You might wonder why you need to make marks for the next row. As you learned in “Lesson Eleven: Marking Your Placements,” marks ensure you can get back on track with quilting if there’s an interruption or mistake. Additionally, after you stitch out a few rows, you will run out of room in the available quilting space and need to roll your fabric. When you move your fabric on the frame, there’s no way for the software to track where the fabric is moved and where the next row of designs is supposed to be placed. But if you have put down marks on your quilt where the next row is supposed to be placed, you can use those marks to tell the software where to place the next row.

PRACTICE STEPS

- 1 After you’ve finished your row first row of stitching, the machine needle moves to the bottom right corner of the row you just sewed. This is where you mark the top-right placement for the next row underneath.

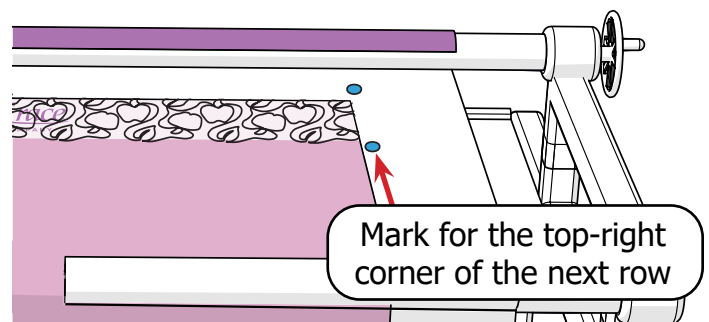
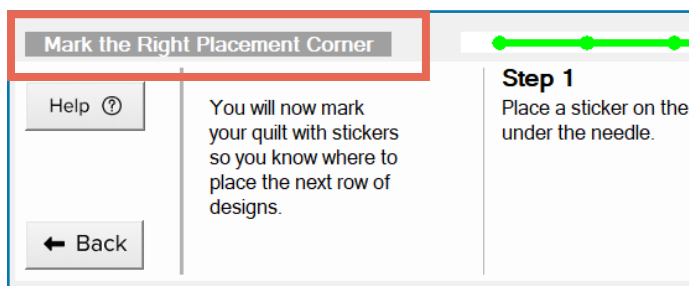

Place a sticker on the quilt sandwich, under the hopping foot.

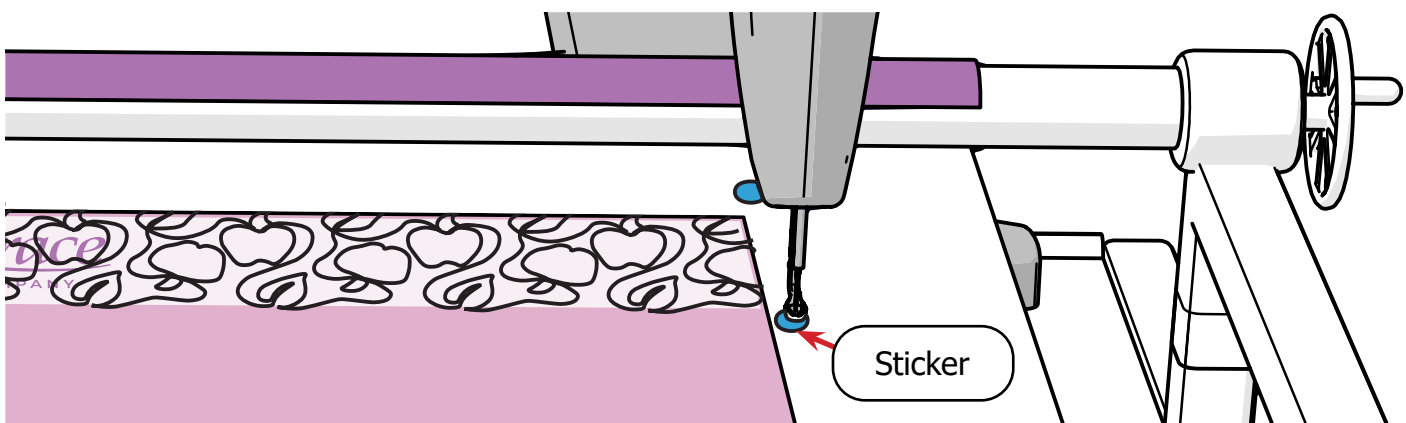

- 2 Press **Single Stitch** on the screen to puncture the sticker. The hole is the exact point you will use when placing the row later.

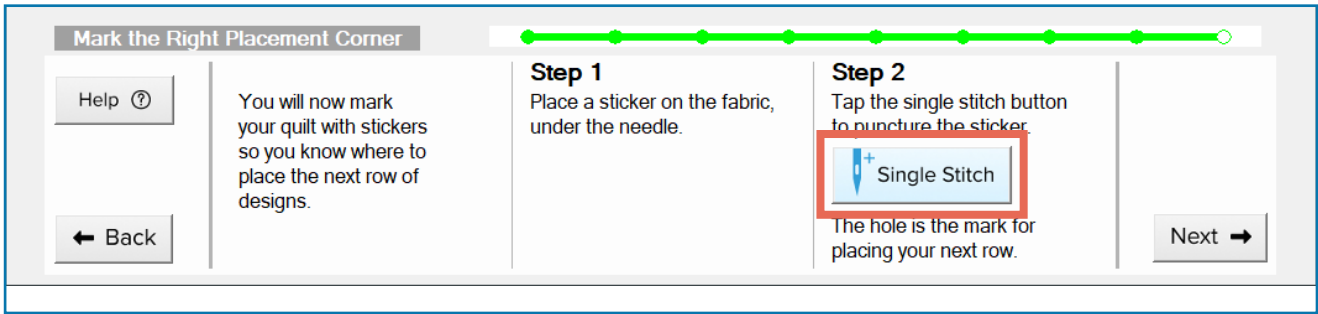

- 3 Tap **Next**.

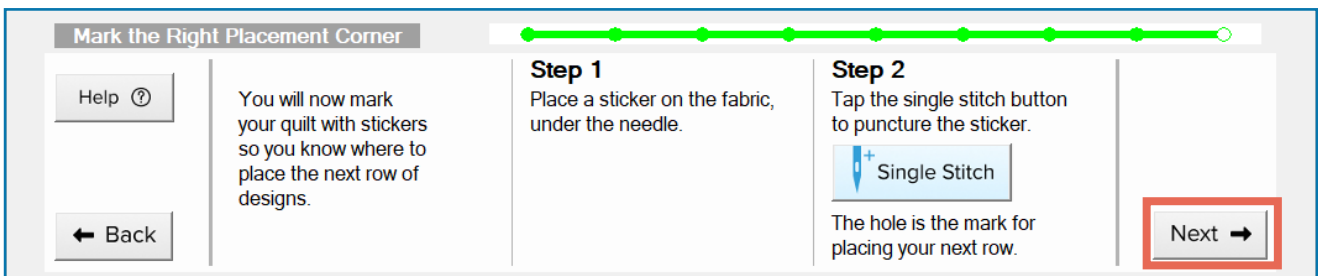

The machine moves to the left side of the quilt and you must mark the left corner.

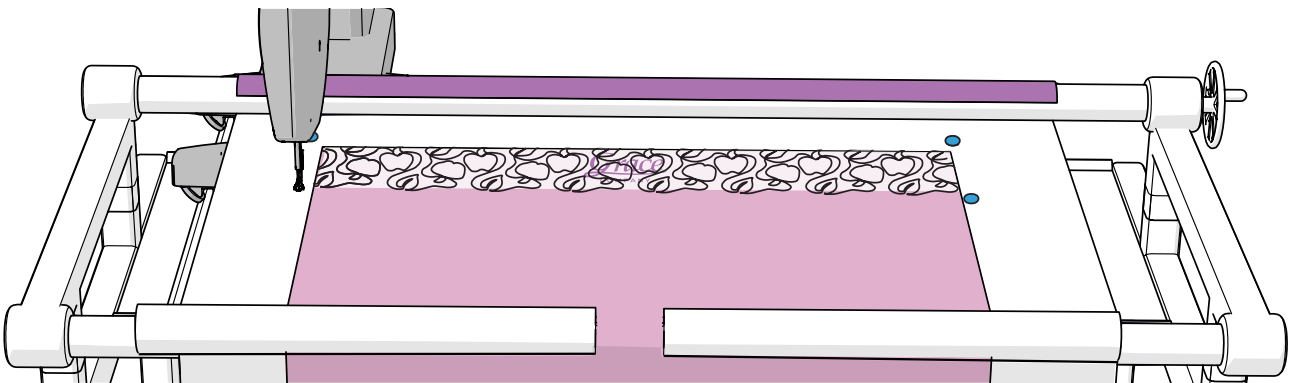

- 4 Apply another sticker to the quilt top, under the hopping foot. Repeat steps 2–3 to mark the sticker.

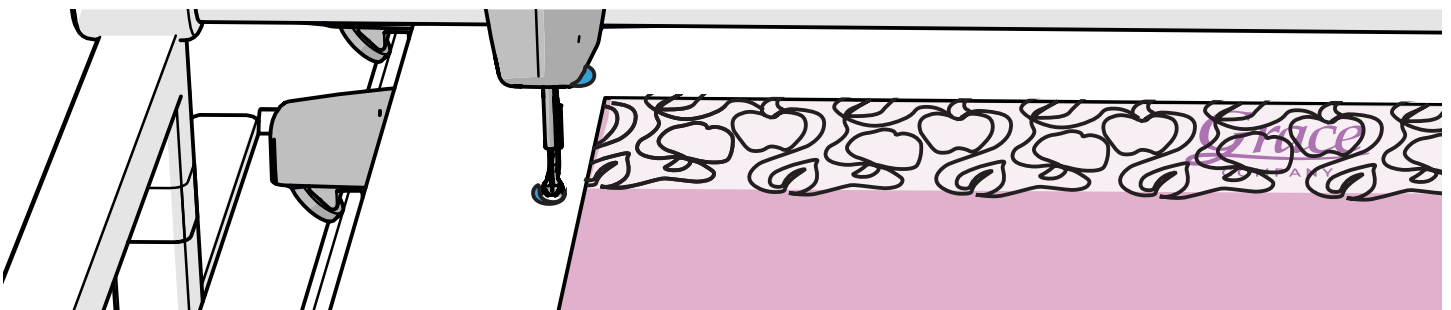

16

Lesson Sixteen: Placing Your Next Row

KEY CONCEPT

The next row down is placed according to the marks you made at the end of the row above.

The puncture holes you made in the sticker in the previous lesson are the marks you will use in this lesson to place your next row of designs underneath the row you just stitched.

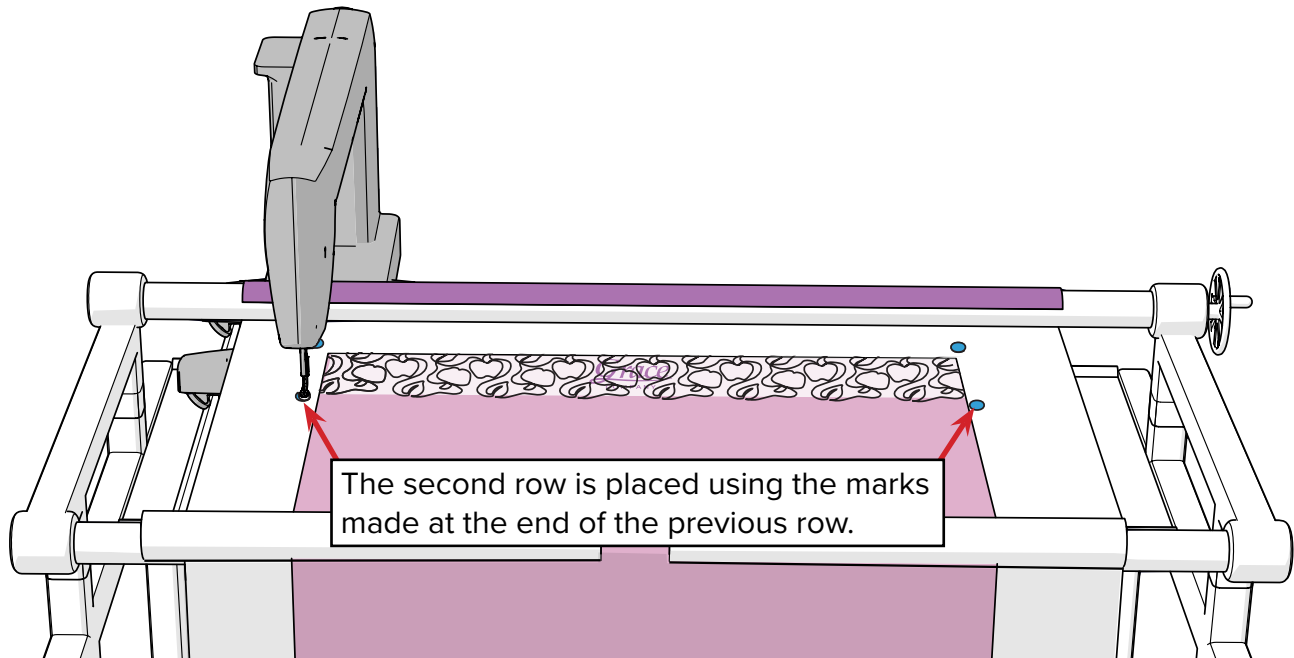

Using the skills you have already practiced, you will point with your machine's needle and press the nodes on the screen to tell the software where to stitch out the next row of designs.

PRACTICE STEPS

- 1 Move your needle directly over the hole you made in the bottom sticker on the left side of the frame. Press the gray node on the left side of the screen so the node turns green.

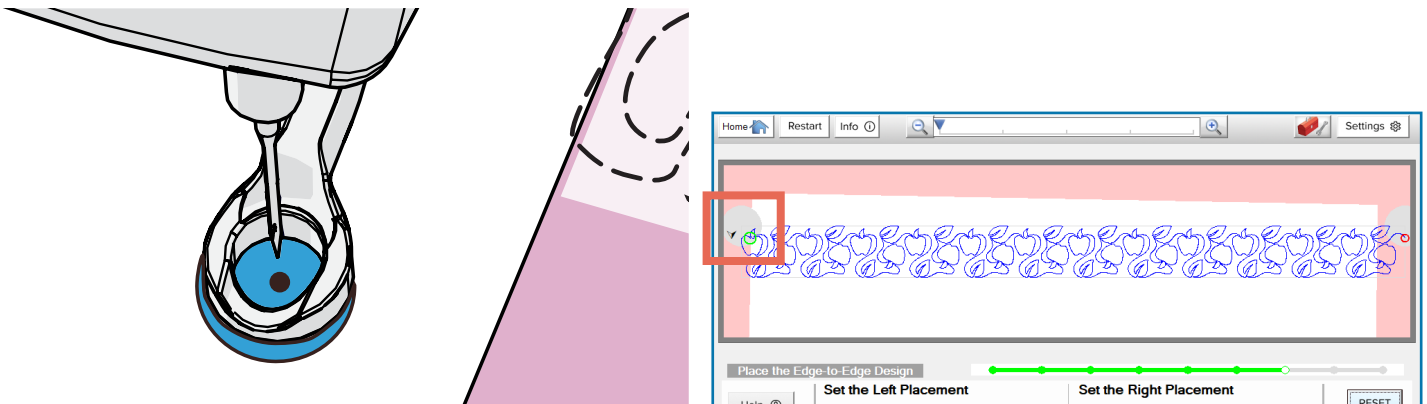

- 2 Move your needle directly over the hole you made in the sticker on the right side of the frame. Press the gray node on the right side of the screen so the node turns green.

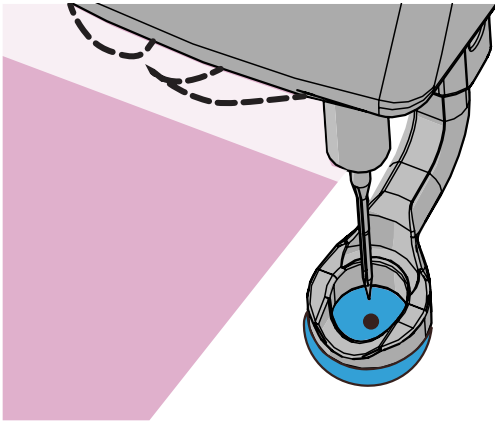

- 3 Press **Next**.

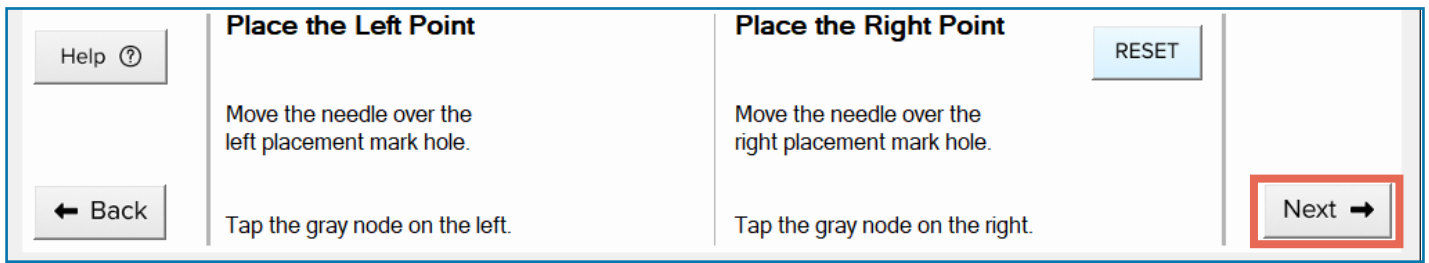

- 4 You've learned the basic process for stitching out a row of designs! Repeat the steps starting from "Lesson Twelve: Pulling the Bobbin (start)" on page 44 to stitch out your next row and place the row after that. Continue cycling through the steps in these lessons until the following message appears on the screen:

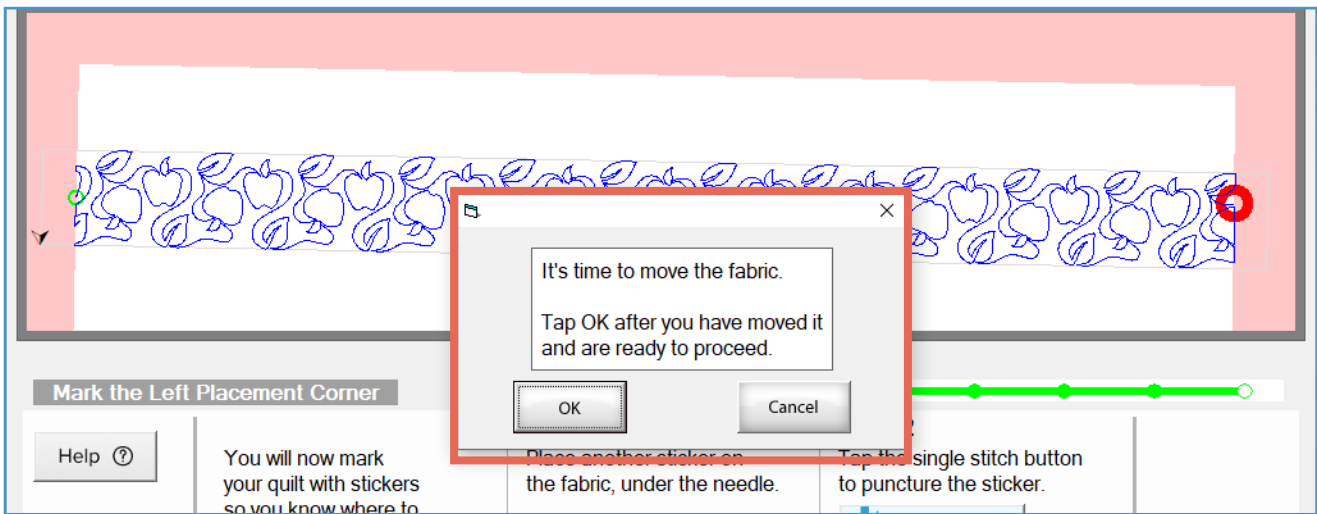

This message means that there is not enough room left in your safe area for you to stitch out or mark another row and it is time to move your fabric to a fresh quilting space. Continue to Lesson 17.

17

Lesson Seventeen: Shifting Your Fabric

KEY CONCEPT

It's best practice not to shift your fabric until instructed to by the software. Never shift your fabric until you've marked for the next row.

The exact process of shifting your fabric is covered in your frame's instruction manual.

Once you've moved your fabric, the software has no way of tracking where the designs you've already stitched out are located on your quilt. This is why you must never shift your fabric until you have the marks for your next row. Don't worry, the software never prompts you to shift your fabric until the marks are made, so it is best practice not to shift the fabric until the software instructs you to.

After shifting your fabric, you must tell QCT6 where the new quilt-top edges are and you must tack down those edges.

PRACTICE STEPS

- 1 Roll your fabric so a fresh, unquilted portion of the quilt top or panel is between the rails. Make sure a few inches of the previous rows fall within the safe area. See your frame's instruction manual for details on moving your fabric.

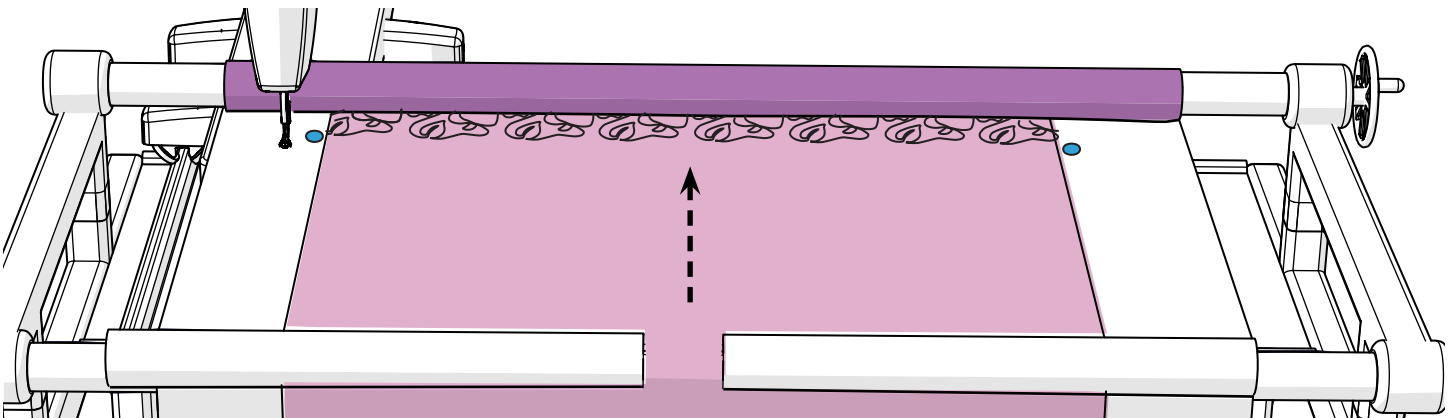

Note: In designs where the starting and end point are more toward the center of the design, or there is a high degree of nesting, you'll need more overlap with the previous rows.

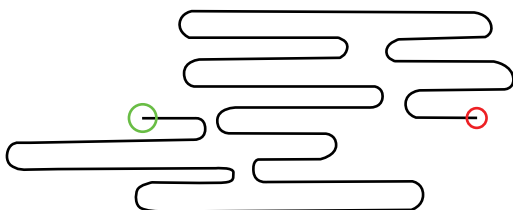

The start and stop points are toward the center of the design.



The design has a high degree of nesting.

- 2 When you're finished moving your fabric, tap **OK** on the screen.

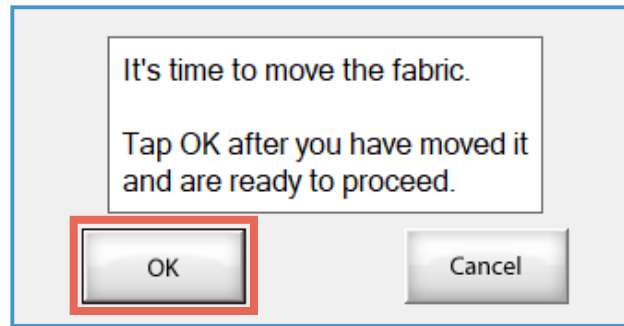

- 3 The sewing machine and carriage are released so the machine can be moved and used. Tack down the rest of the top edge and then tack down the right edge of the quilt top.

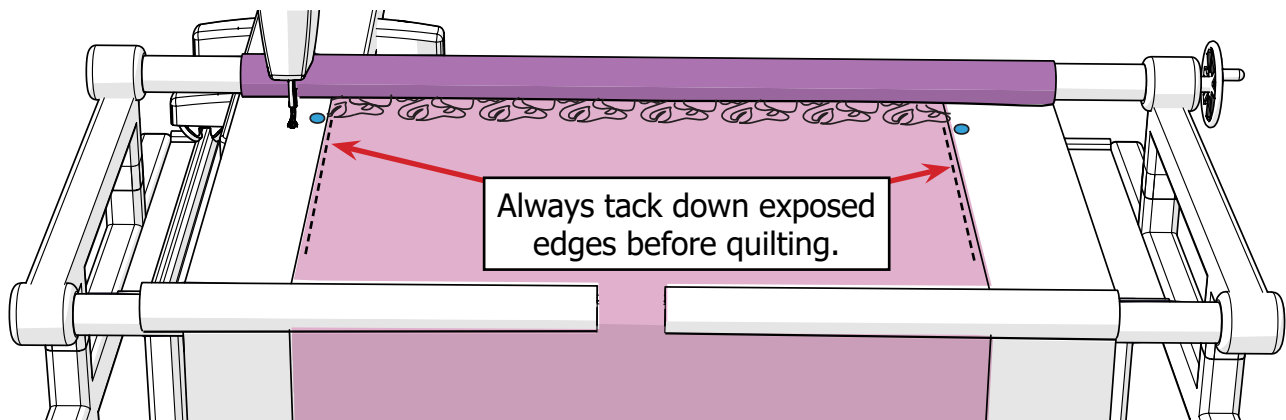

- 4 The Quilt Top Edge Selection screen displays again. Now that you've shifted your fabric, you must tell the software which section of the quilt you've moved to. Unless you're working with a very small quilt, you will usually select the middle button after you've quilted the top section.

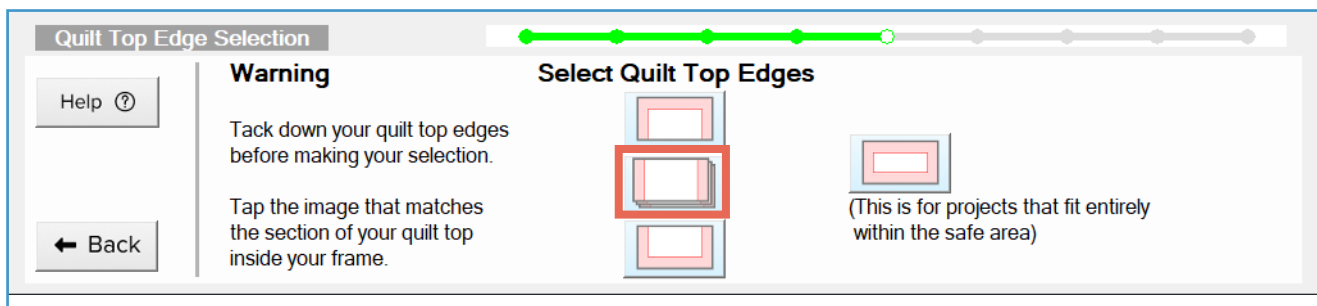

Note: If it looks like you might be at the end of the quilt because you can see the bottom edge of the quilt top within the rails, pull your machine all the way forward. Only choose the bottom button if your machine's needle can easily reach the bottom edge of the quilt.

- 5 The Set Fabric Edges screen opens. Just like you learned in “Lesson Eleven: Setting the Quilt-Top Edges” on page 36, align the needle with the edges and corners and tap the corresponding nodes until they are green.

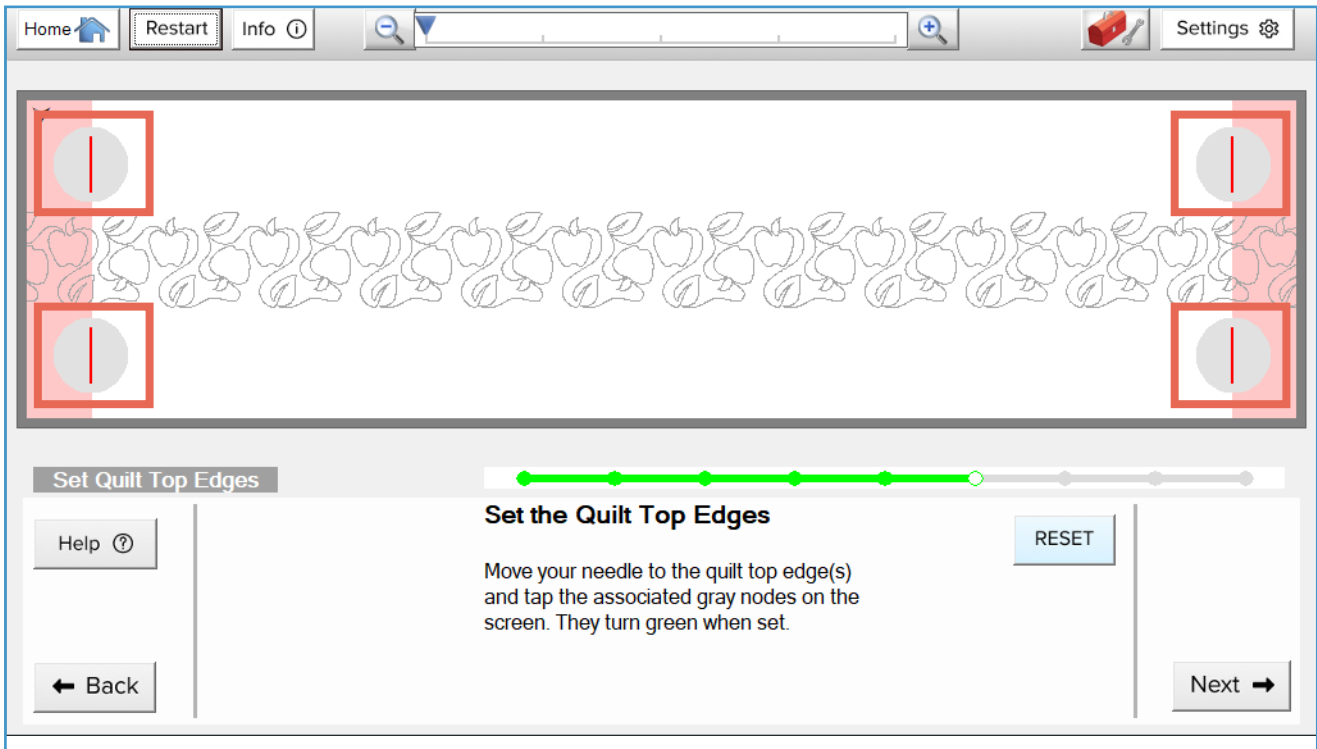

- 6 Press **Next** when the edges are set.

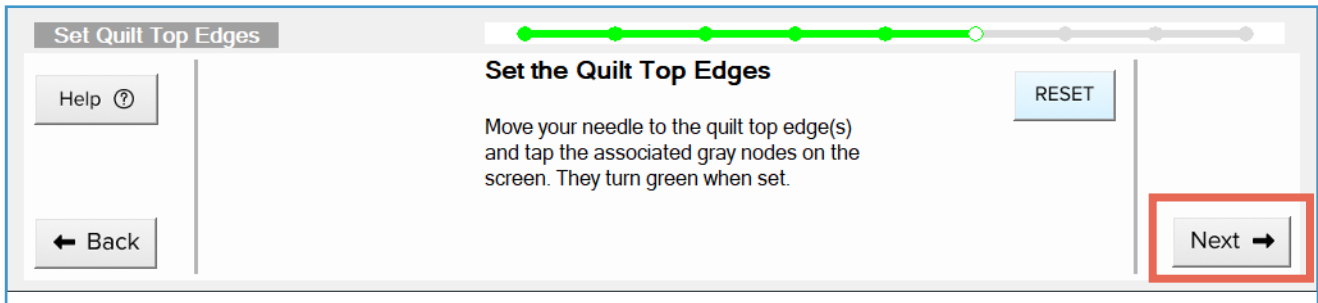

- 7 The design placement, quilting, and marking processes are the same as you learned earlier, so continue to practice until you’ve finished your panel or quilt top! Don’t forget to review “Lesson Eighteen: Repairing Your Design” on page 58 when you run out of bobbin thread or “Lesson Nineteen: Taking a Break” on page 63 when you want to take a break from quilting.

18

Lesson Eighteen: Repairing Your Design

KEY CONCEPT

Use Repair Pattern if anything interrupts your design.

Eventually, something is going to go wrong in the middle of a quilt. You'll run out of bobbin thread halfway through a row of designs, or your power will go out on the whole system in a freak storm. Repair Pattern is a tool that allows you to come back strong from any disaster. You can find detailed instructions on using this tool in your Quilter's Creative Touch 6 Software Registration & Use manual, but this lesson will cover what to do when you run out of bobbin thread in the middle of a row—a common occurrence.

When the thread runs out in the middle of a row, the machine continues happily stitching away, unaware that all it is doing is poking holes through your quilt. It's up to you to notice when the stitching has stopped working, refill the bobbin, and then guide the automation software back to the correct place to continue sewing.

PRACTICE STEPS

- 1 If you have come to this lesson because you ran out of bobbin thread already, proceed to step 2.

If you're not sure when you might run out of bobbin thread but would like to practice the steps in this lesson anyway, you can continue sewing until your bobbin thread runs out, or you can simulate running out of bobbin thread by doing the following:

- a Some time in the middle of sewing out a new row, press the stop button on the screen. The machine stops moving.



- b Underneath the quilt, remove the bobbin case from the machine and cut the bobbin thread with scissors. Trim away any excess bobbin thread dangling from the back of the quilt.

CAUTION: Do not run the machine with the needle threaded when there is no bobbin case in the machine.

- c Unthread the needle.

- d Do not return the bobbin case to the machine yet. Back on the screen, tap, “Sew.” The machine starts stitching, but it can’t complete the stitches because there is no thread in through the needle.

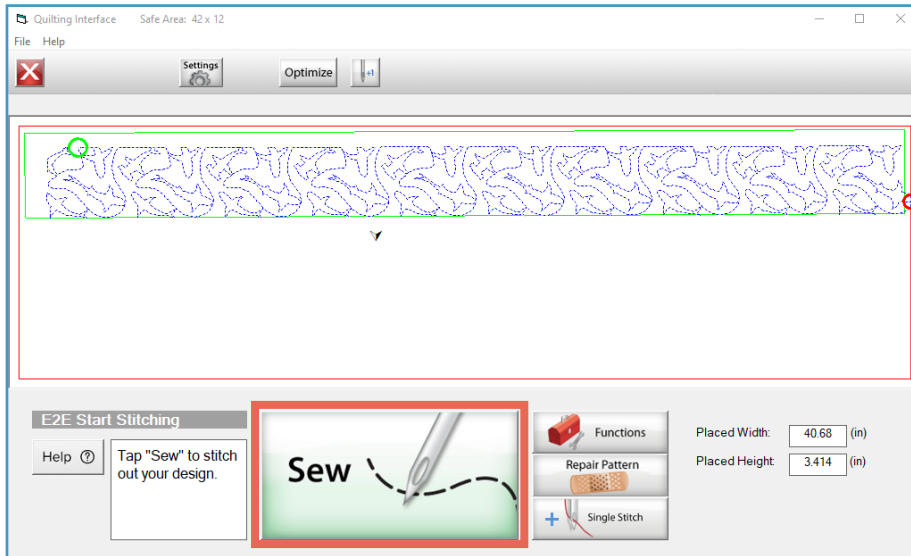

IMPORTANT: The machine moves when you press Sew.

- e Let the machine attempt to stitch for another 15–20 seconds and go to step 2.

- 2 If your machine is still attempting to make stitches, press **STOP** on the screen.



- 3 Refill your bobbin and reload the bobbin case. Follow your machine instructions for details.

- 4 When the machine is ready to sew again, tap **Repair Pattern**. The E2E Repair screen displays. E2E Repair contains the tools you need to finish stitching out a design that was interrupted.

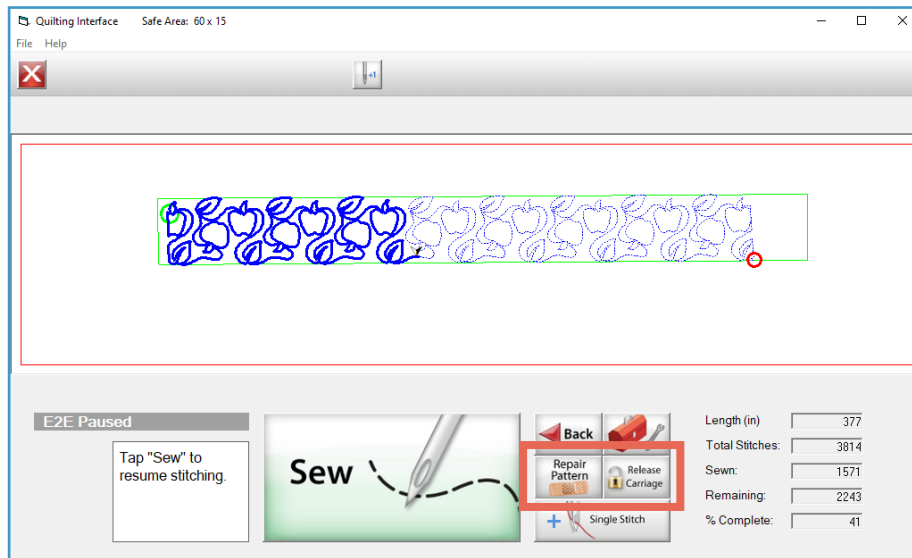

- 5 Move your machine so the needle is over one of the **last stitches** the machine successfully made. Make sure to check that the stitch was completed underneath the quilt as well as on the top. Sometime a stitch can look right from the top but is not actually a completed stitch underneath.

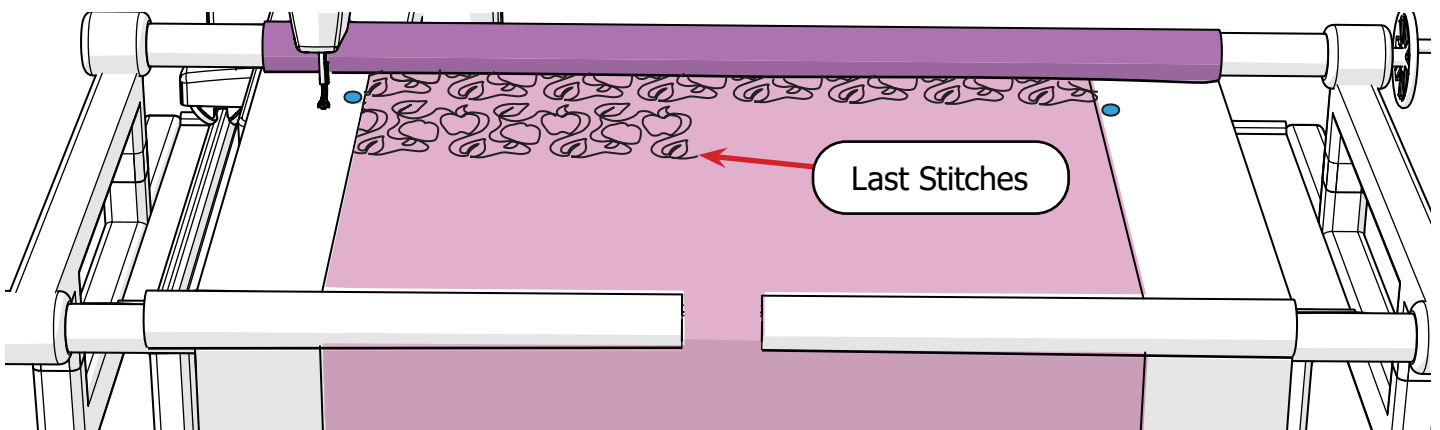

- Use the **Single Stitch** button on the screen to manually pull up your bobbin thread through one of these last stitches. See page 10 for a review on pulling up the bobbin thread.

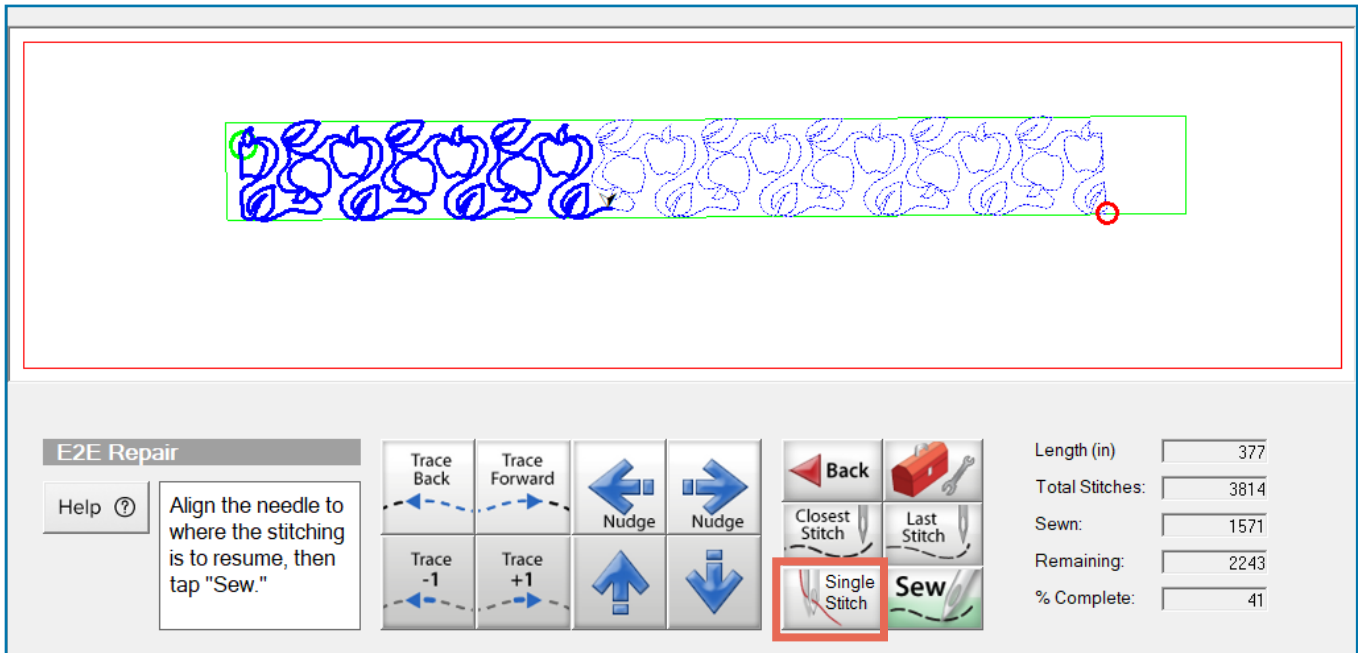

- Move your machine over where you pulled the bobbin and tap **Closest Stitch**. The machine compares the location of the needle with its map of where the stitches are supposed to be and moves the machine directly over the stitch that is closest to where you moved the needle.

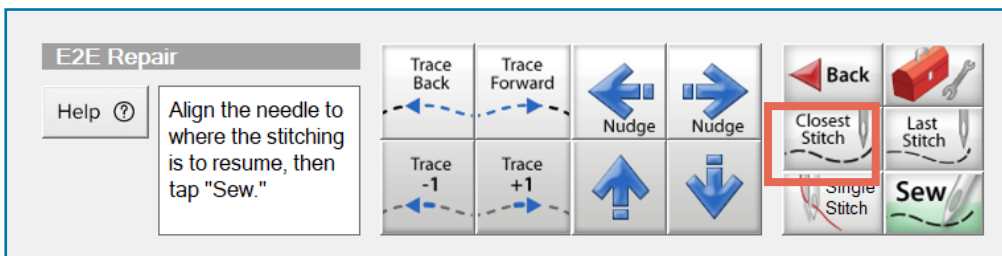

IMPORTANT: The machine moves when you press Closest Stitch.

- In the preview window on the tablet screen, the software estimates the part of the design the needle is over.

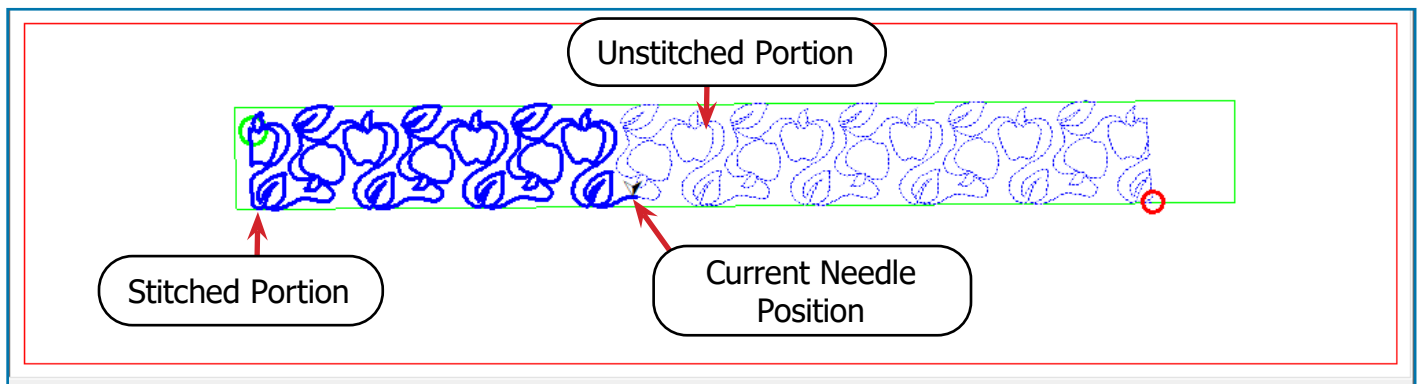

Compare the stitched portion of the design in the preview window with what has been stitched out on your quilt.

TROUBLESHOOTING

The stitched-out portion of the quilt should be a close match to what is on the preview window on the screen. If it is not, the quilt was probably shifted on the frame after the placement was set. Try going back and placing the design again. Then skip the Pull Bobbin (start) screen and start again at step 4.

9 Press **Sew**. The machine does a tie off stitch and continues from that point of the design.

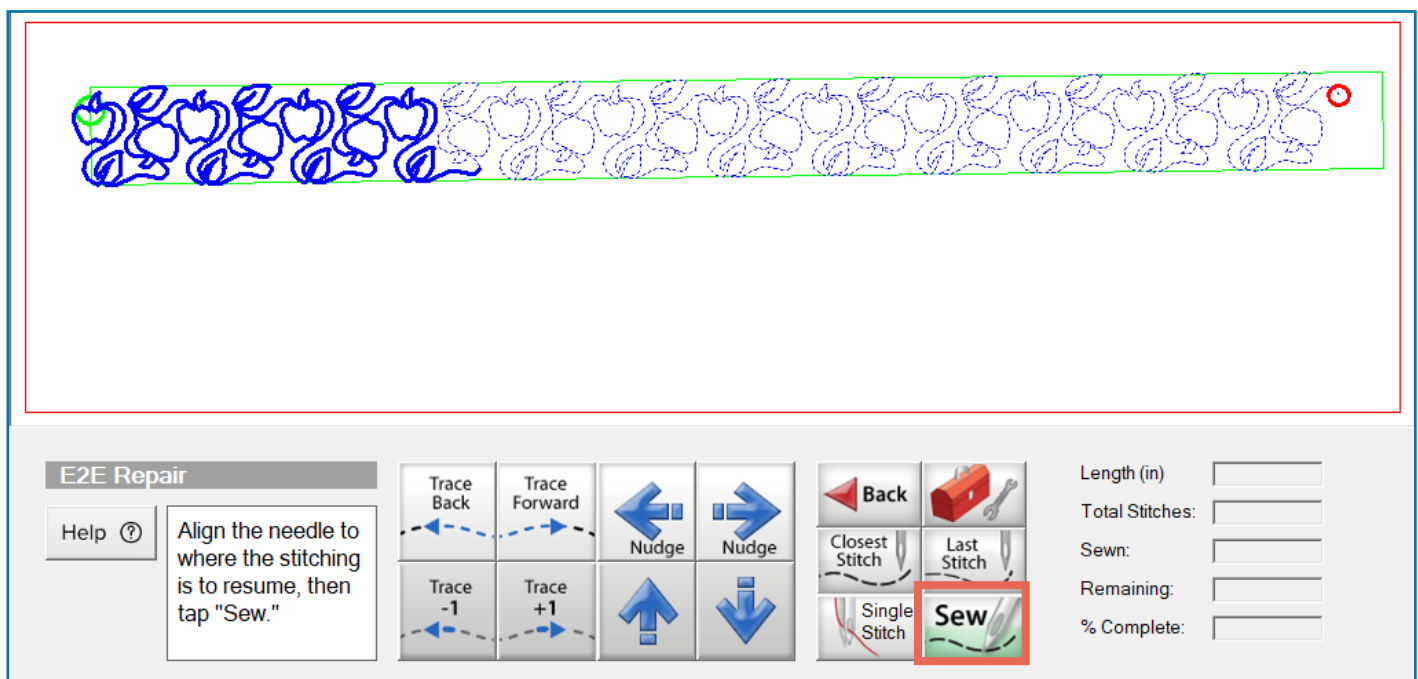

EXTRA CREDIT

The trace buttons move the needle along the sewing path. Trace +1 and -1 move the needle a single stitch, while Trace Forward and Trace Back will move the machine until you tell it to stop or it reaches the end of the row.

The nudge buttons move the needle a small amount without tracking that movement in the software. The software will “think” the machine has not moved, but the needle is over a slightly new position. This comes in handy if the fabric has shifted slightly.

19

Lesson Nineteen: Taking a Break

KEY CONCEPT

Don't just close the software at any point when you're done quilting. Make sure you're in a good stopping place.

When you want to stop quilting for the day, you must come to a good stopping point. For example, it would be bad to close the program immediately after you finish stitching out a row, without placing your marks. Set yourself up for a successful return by taking the following steps.

PRACTICE STEPS

- 1 Make sure your marks are in place for your next row. If you're in the middle of stitching a row of designs, finish that row and proceed through all the marking screens. It is very important that your marks for your next row have been set before you close QCT6.
- 2 If you haven't already done so, record the file name for your design, your design height, and your design spacing somewhere you'll be able to easily find it again. See "Lesson Eight: Adjusting Your Row Spacing" on page 30 for details on finding this information in the software.

The screenshot shows the 'Quilter's Creative Touch 6' software interface. The title is at the top center. Below it are four input fields with labels and handwritten entries:

- Quilt Size:** An empty rectangular input field.
- Design Name:** A rectangular input field containing the handwritten text 'elephants e2e'.
- Pantograph Height:** A rectangular input field containing the handwritten text '3 inches'.
- Row Spacing:** A rectangular input field containing the handwritten text '-7/8 inches'.

The interface is framed by a decorative border of vertical lines on both sides, with the numbers 1, 2, and 3 appearing at the top and bottom of the border.

- 3 If your marks for your next row are prepared and you have recorded your design file name, height, and spacing, you can close QCT6.

CONCLUSION

Congratulations! You have learned everything you need to know to quilt an edge-to-edge design over an entire quilt. We hope you found this workbook fun and instructive, and that you can't wait to get quilting with Quilter's Creative Touch 6 again!

EXTRA CREDIT

At the start of this workbook, you were asked some key questions:

- What is the safe area, and why is it critical to the safety of your machine?

You learned that the safe area is where the needle can go on the quilt frame without the machine bumping into the frame rails or stitching off the edges of the quilt sandwich, into open air.

- Why are the placement marks so important?

The placement marks ensure your rows will be straight and even all across and down your quilt, especially after you shift your fabric. They also allow you to continue quilting after a voluntary break or an unexpected shut-down.

- Why do I need to keep track of which fabric edges are within the hoop of the frame?

The fabric edges determine where the design is placed, where the design edges are clipped, and which marking and placement methods are used in subsequent rows.

NOTES



www.graceframe.com
1-801-485-6688