

# HCS3

Compact Single-head Embroidery Machine

## INSTRUCTION BOOK

Program Ver. \*3.00 ~



**HappyJapan**

Original instructions

S3V617-2



IMPORTANT SAFETY INSTRUCTIONS ...	1-1	SEWING WITH TUBULAR FRAMES	
WARNING LABELS & THEIR LOCATIONS .....	1-2	Installing and removing the frame base ..	6-1
SETTING UP THE MACHINE		How to hoop .....	6-2
Remove the machine from box,		Putting the hoop on the machine .....	6-3
How to carry machine .....	2-1	Starting to embroider .....	6-4
Placement of Accessories .....	2-2	CAP FRAME (OPTION)	
Accessories .....	2-3	Changing the needle plate .....	7-1
Assemble machine unit .....	2-4	Installing and removing the cap drive frame ..	7-2
Assemble table (Option) .....	24b	Normal cap frame .....	7-5
Assemble table stay and table (Option) ..	24c	Wide cap frame .....	7-8
Assemble border frame (Option) .....	24e	Starting to embroider .....	7-B
Machine installation .....	2-5	Use of Y +10mm cap hold frame .....	7-D
Grounding instruction, Disposal of a battery ..	2-7	ADJUSTING THE THREAD TENSIONS ...	8-1
MAIN PARTS .....	3-1	SEWING	
THE CONTROL BOX .....	3-3	What to do if the thread breaks while sewing	9-1
DRIVE MODE .....	3-4	Stopping and resuming sewing .....	9-1
Frame change .....	3-8a	Loss of power while embroidering .....	9-2
MENU .....	3-A	Moving the hoop while embroidering and then returning to the correct location (Position) .....	9-3
INSERTING A NEEDLE .....	4-1	Moving back to the starting point (Origin)	9-3
SELECT NEEDLES AND THREADS .....	4-2	Going back to the beginning of the design (Top) ...	9-4
BACKING MATERIALS .....	4-3	Placing the design in the center of the selected embroidery frame (Center) .....	9-4
BOBBIN WINDING		Rotating and mirroring designs (Convert) ..	9-5
Winding the bobbin .....	4-4	Starting in the middle of a design (Position) ...	9-6
Removing the bobbin .....	4-5	POSITION ALIGNMENT BY DEFINING 2 POINTS ..	9-8
Inserting the bobbin .....	4-5	POSITION .....	9-B
Adjusting bobbin thread tension .....	4-5	Piece number .....	9-C
Inserting the bobbin case .....	4-5	Bobbin thread alarm .....	9-Cb
THREADING THE MACHINE		Work save .....	9-Ce
How to thread upper thread .....	4-6	REGISTER .....	9-D
HOW TO READ THESE INSTRUCTIONS and SCROLLBAR	4-8	Entry .....	9-E
DISPLAYING THE PATTERN IN SETTING MODE ...	4-9	Return .....	9-F
TURNING THE MACHINE ON		READING	
How to turn on the machine .....	5-1	Join .....	10-1
How to turn off the machine .....	5-1c	Pattern Read Settings .....	10-3
Calendar and clock setting .....	5-2	PATTERN	
MESSAGE .....	5-3	Locking pattern data .....	11-1
PREPARATION OF PATTERN DATA		Trace type .....	11-2
Connecting to a PC .....	5-4	Export .....	11-3
Reading embroidery pattern data from the PC .....	5-4b	Renaming patterns .....	11-5
Read embroidery pattern data .....	5-5	Copying pattern data .....	11-6
Reading pattern data .....	5-6	Moving pattern data .....	11-7
Search .....	5-8	Renaming folders .....	11-9
Selection of folders .....	5-9	Sort .....	11-A
How to select patterns from memory .....	5-A	Thread break report .....	11-B
Erasing patterns from memory .....	5-B		
NEEDLE BAR SELECTION .....	5-E		

Retrieve built-in data from machine .....	11-C	SCREEN SAVER.....	21-1
Searching pattern data.....	11-D	i-CUSTOM .....	22-1
NEEDLE BAR SELECTION .....	12-1	LAN connection .....	22-2b
Auto setting.....	12-2	TASK RESERVATION .....	22-2c
Thread color.....	12-4	Reading.....	22-2d
Color change data registration.....	12-6	Needle bar selection .....	22-2e
Color change data read .....	12-7	Setting.....	22-2f
Repetition of color group setting .....	12-8	Search.....	22-2g
FRAME CONFIRMATION .....	13-1	List .....	22-2h
Frame selection.....	13-2	Letter.....	22-2i
Adjusted for embroidery area .....	13-4	Layout .....	22-2j
User-defined frames (1 ~ 5).....	13-7	USER MANAGEMENT	
User-defined frames (6 ~ 20).....	13-A	Registration of administrator.....	22-3
How to change center point of frame (1 ~ 5, 6 ~ 20).....	13-H	Registration of user.....	22-6
Non registered .....	13-J	Selection of user (Login).....	22-8
PATTERN SETTINGS .....	14-1	Selection of user (Login) at power ON.....	22-9
Scaling .....	14-2	LAYOUT .....	22-A
Width adjustment .....	14-3	THREAD SET.....	22-J
Angle.....	14-4	SPECIFICATIONS • MAINTENANCE	
Repeat sewing .....	14-5	Specifications.....	23-1
Auto origin.....	14-7	Oiling.....	23-1
Offset .....	14-8	Cleaning of rotary hook	
Frame out .....	14-D	Cleaning of thread cutting knife .....	23-2
MACHINE SETTINGS.....	15-1	ERRORS AND WHAT TO DO .....	24-1
LOCK STITCHES .....	15-5	INITIALIZING OF MACHINE SETTINGS	
LETTER.....	16-1	Re-Initialization of machine system .....	25-1
QUEUE.....	17-1	Initialize the PMS .....	25-1
Alter and Execution .....	17-2	Initialize the Network.....	25-1
Needle bar selection and Pattern settings.....	17-4	Initializing of machine speed.....	25-2
Registration of QUEUE setting .....	17-6	HELPFUL HINTS.....	26-1
Read QUEUE setting.....	17-7	EMBROIDERY TERMS.....	26-2
OTHER SETTINGS		BUILT-IN FONT LIST.....	26-3
Create network .....	18-1	BUILT-IN PATTERNS LIST.....	26-4
Wire LAN connection setting .....	18-2b	VARIOUS SPECIAL FRAMES (OPTIONS)....	27-1
Wireless LAN connection settings (Option)...	18-2e		
Version information.....	18-3		
Language.....	18-5		
Calibrate .....	18-6		
User maintenance mode.....	18-8		
Report.....	19-1		
GUIDE .....	20-1		

This electrical appliance is intended for household use.

When using an electrical appliance, basic safety precautions should always be followed, including the following.

## Read all instructions before using this appliance.



### **DANGER** - To reduce the risk of electric shock:

1. An appliance should never be left unattended when plugged in. Always unplug this appliance from the electric outlet immediately after using and before cleaning.



### **WARNING** - To reduce the risk of burns, fire, electric shock, or injury to persons:

1. Do not allow to be used as a toy. Close attention is necessary when this appliance is used by or near children.
2. Use this appliance only for its intended use as described in this manual. Use only attachments recommended by the manufacturer as contained in this manual.
3. Never operate this appliance if it has a damaged cord or plug, if it is not working properly, if it has been dropped or damaged, or dropped into water. Return the appliance to the nearest authorized dealer or service center for examination, repair, electrical or mechanical adjustment.
4. Never operate the appliance with any air openings blocked. Keep ventilation openings of the sewing machine and foot controller free from the accumulation of lint, dust, and loose cloth.
5. Never drop or insert any object into any opening.
6. Do not use outdoors.
7. Do not operate where aerosol (spray) products are being used or where oxygen is being administered.
8. To disconnect, turn all controls to the off ("0") position, then remove plug from outlet.
9. Do not unplug by pulling on cord. To unplug, grasp the plug, not the cord.
10. Keep fingers away from all moving parts. Special care is required around the sewing machine needle.
11. Always use the proper needle plate. The wrong plate can cause the needle to break.
12. Do not use bent needles.
13. Do not pull or push fabric while stitching. It may deflect the needle causing it to break.
14. Switch the sewing machine off ("0") when making any adjustments in the needle area, such as threading needle, changing needle, threading bobbin, or changing presser foot, etc.
15. Always unplug sewing machine from the electrical outlet when removing covers, lubricating, or when making any other user servicing adjustments mentioned in the instruction manual.

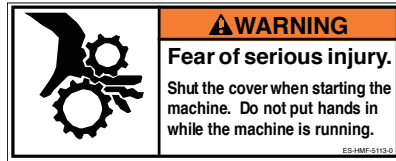
## SAVE THESE INSTRUCTIONS

# WARNING LABELS & THEIR LOCATIONS

1-2

## Trapping hazard

Shut the cover when starting the machine.  
Do not put hands in while the machine is running.



## Trapping, Puncture, Cut hazard wherever this label is found



## Shock hazard on all electrical components



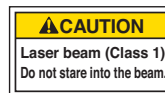
## Injury risk on moving head(s)

Keep hands away from the moving heads while the machine is running.



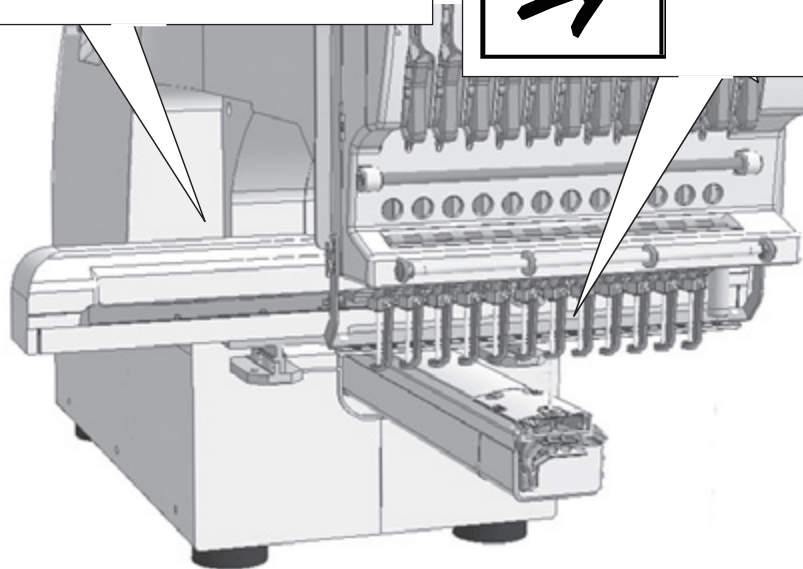
## Laser beam (Class 1)

Do not stare into the beam.



**CAUTION: Injury risk on frame and carriage**  
Keep hands away from the drive frame while the machine is running.

**WARNING: Injury risk warning for all needles**  
Keep fingers away from the needles while the machine is running.



# SETTING UP THE MACHINE

# 2-1

We recommend unpacking should be done where it has enough room.



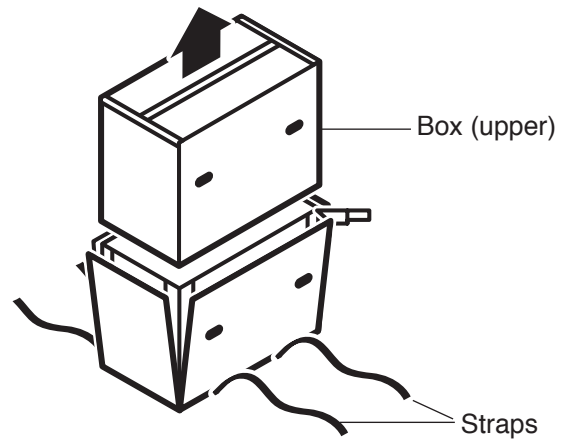
### CAUTION: To prevent accidents.

The machine is quite heavy for one person to carry. Please use two persons when unpacking or carrying.



### CAUTION: To avoid problems.

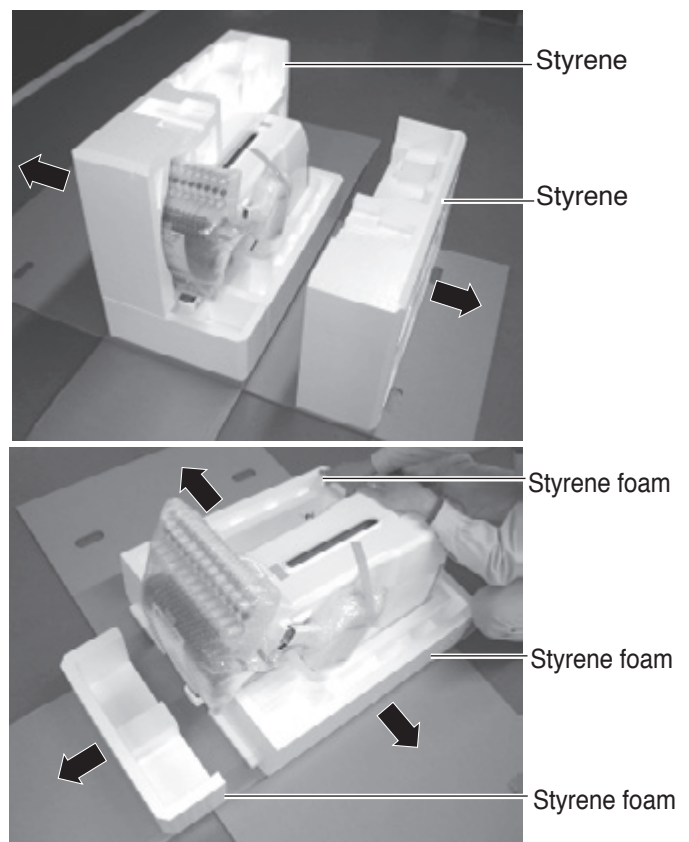
Make sure to hold bottom of the machine body when removing from the box. Do not hold any other place. (bed, moving head, control box etc.).




## ● Remove the machine from box

1. Remove 2 straps from the carton.
2. Lift the box (upper) to remove.
3. Take out the accessories.  
Refer to the next page.
4. Take out the styrene foam (right) and (left) in the direction of the arrow.
5. Take out the styrene foam (lower front), (lower right), and (lower left).  
Be careful not fall down the machine, tilt the machine slightly when taking out the styrene form (lower right) and (lower left).
6. Carry the machine to installation location.

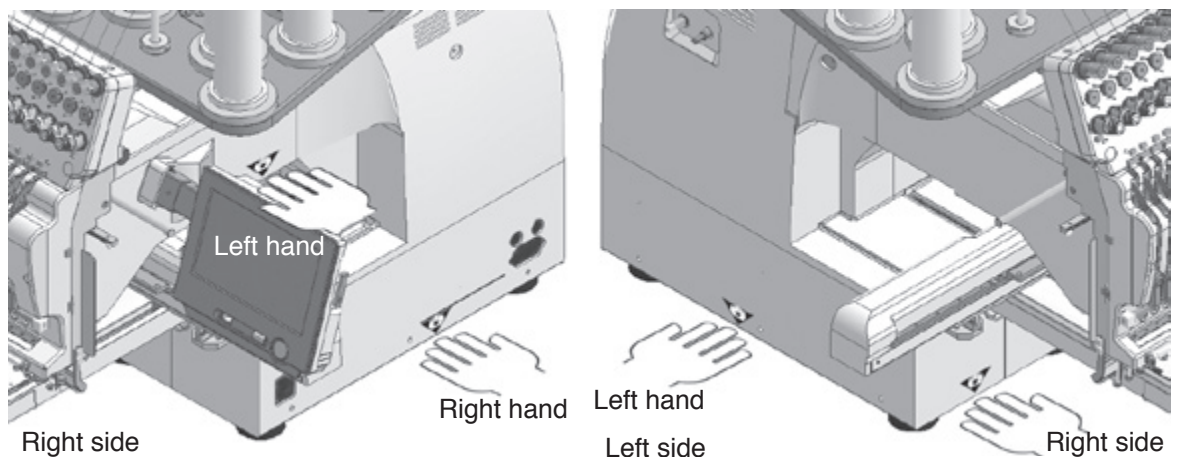
- Please keep those packing materials in case of necessary for repair or other reasons.
- Packing procedure is the reverse from unpacking procedure.



## ● How to carry machine

The unpacked machine should be carried by 2 person with the hand position at  shown in photos.

The person holding the machine from right side need to hold the machine arm by left hand.



## ● Placement of Accessories

Confirm all the accessories are contained when unpacking.



Frame base  
USB flash drive (Instruction manual,  
Parts list, Happy Link Software)  
Instruction manual



Embroidery frame (Round)  
Embroidery frame (Square)  
Thread stand  
Thread guide bracket

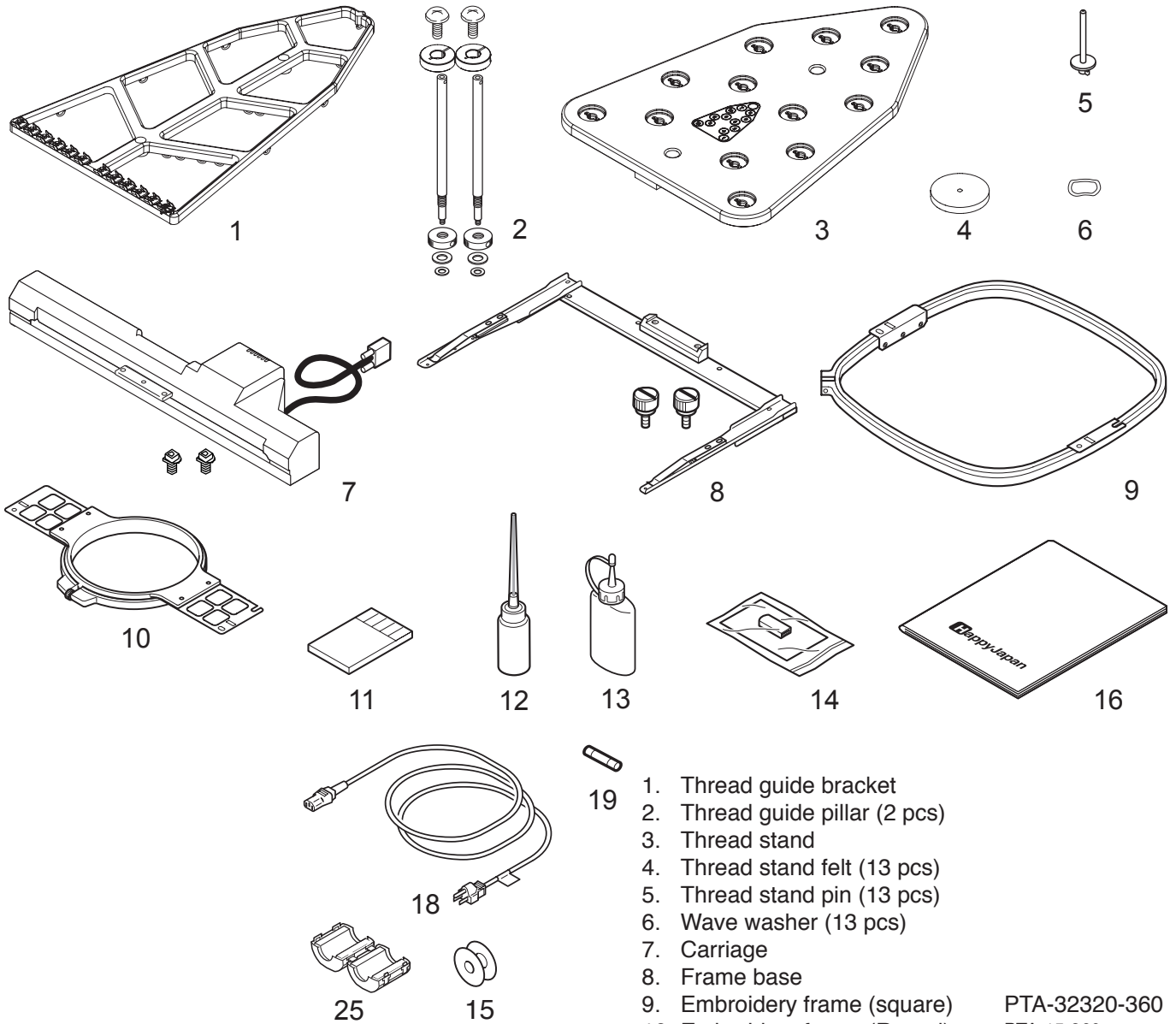


Carriage  
Thread stand felt (13 pcs)  
Power line cord ass'y  
Oiler  
Sewing machine oil  
Thread guide pillar (2 pcs)  
Thread stand pin (13 pcs)  
Wave washer (13 pcs)  
Tool box



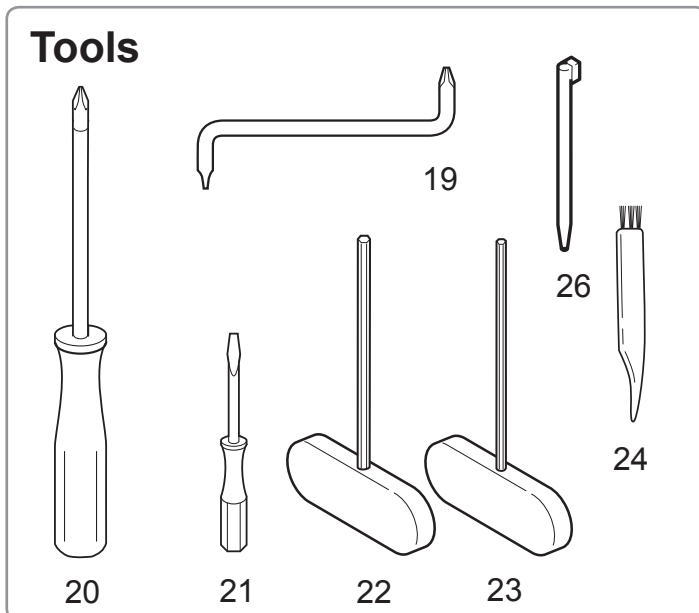
## ●Accessories

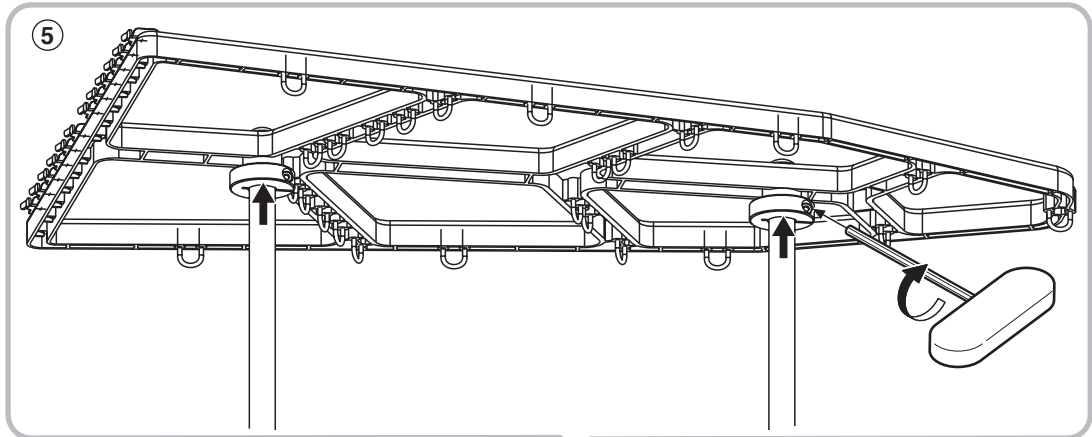
Please confirm you have received the following.



1. Thread guide bracket
2. Thread guide pillar (2 pcs)
3. Thread stand
4. Thread stand felt (13 pcs)
5. Thread stand pin (13 pcs)
6. Wave washer (13 pcs)
7. Carriage
8. Frame base
9. Embroidery frame (square) PTA-32320-360
10. Embroidery frame (Round) PTA-15-360
11. Needle (DB X K5) (10 pcs)
12. Oiler
13. Sewing machine oil
14. USB flash drive  
(Instruction manual, Parts list. Happy Link Software)
15. Bobbin (1 pc)
16. Inst ruction book (USB flash drive)
17. Power line cord ass'y (A shape will be changed depending on a destination)
18. Fuse (6A)
19. Off set screw driver
20. #2 (+) Screw driver
21. 2 mm (-) Screw driver
22. 3 mm hexagonal driver
23. 2.5 mm hexagonal driver
24. Brush
25. Clamp filter
26. Stylus

## Tools





## ● Assemble machine unit

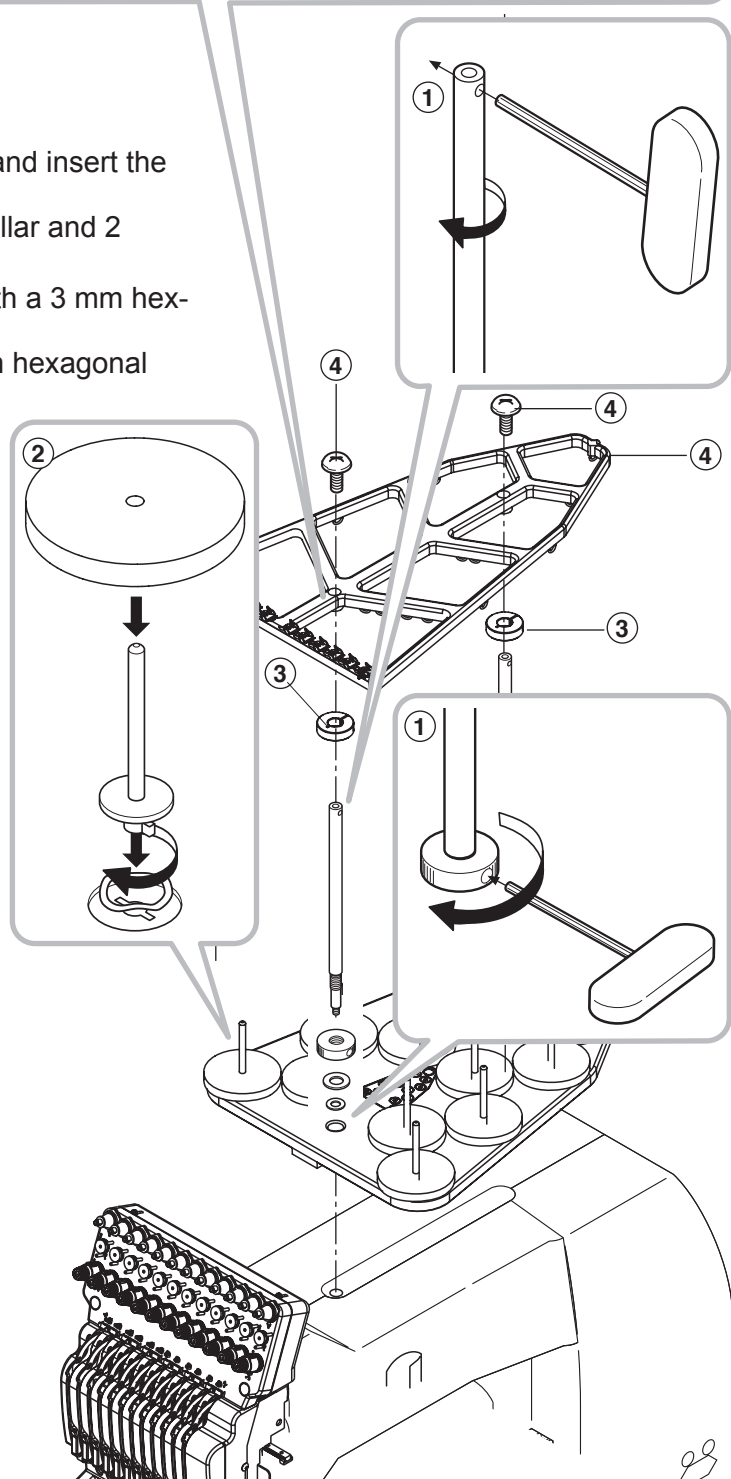
1. Put the thread stand on to the machine and insert the thread guide pillar.  
(set nut knob nut into the thread guide pillar and 2 washers)  
Turn the thread guide pillar clockwise with a 3 mm hexagonal driver until tight.  
Turn the knob nut clockwise with a 3 mm hexagonal driver until tight.

2. Insert the thread stand pin with wave washer on the thread stand by turning clockwise, Then insert thread stand felt.

3. Install the fasten collars to the thread guide pillar.

4. Install the thread guide bracket with supplied screws (M6 x 10 2 pcs).

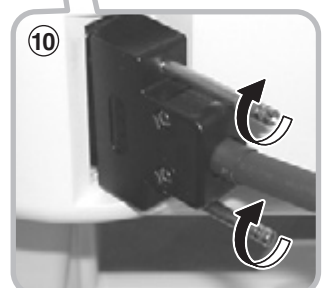
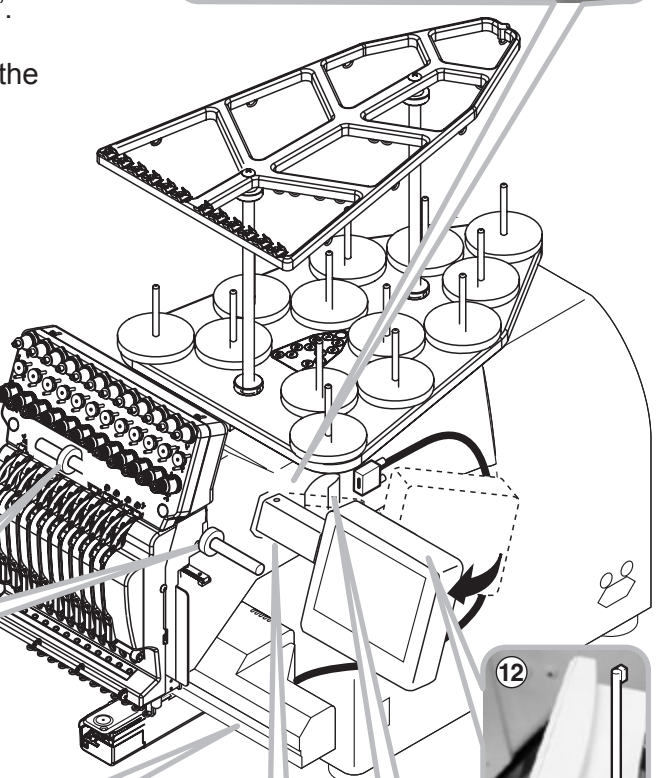
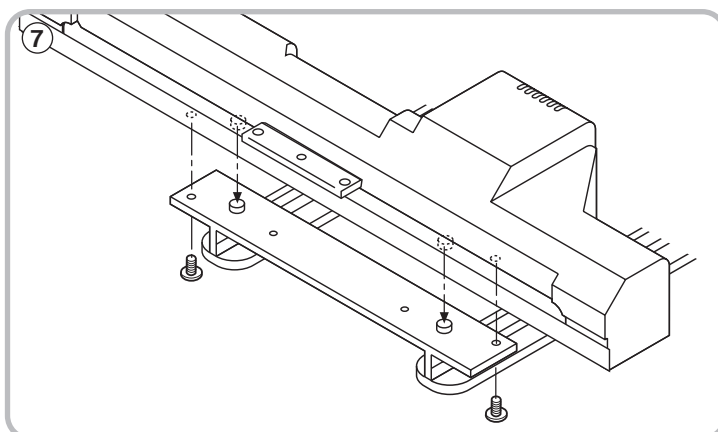
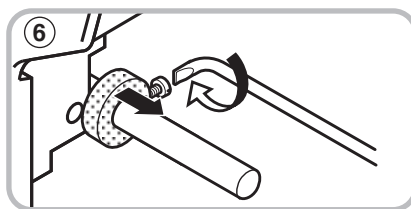
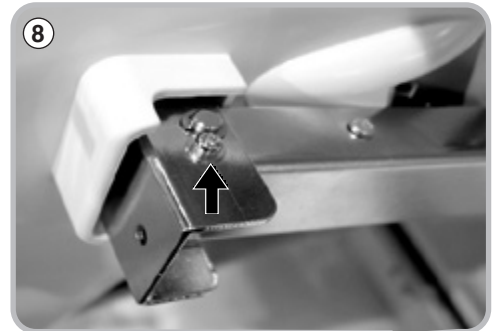
5. Lift the fasten collar up and fix with 2.5 mm hexagonal driver.



# SETTING UP THE MACHINE

2-4a

6. Loosen the screw with a offset driver and remove the red shipping collars that are equipped on the both side of the guide bar. (Keep the shipping collars. It is necessary when packing.)
  7. Put the carriage and carriage arm together with screw (M4 X 8 2 pcs).  
2 pins in the upper carriage arm will fit into holes on the lower carriage.
  8. Remove the fixing screw (M3 1 pcs) that fixing the arm indicated by the arrow. (Keep the fixing screw. It is necessary when packing.)
  9. Raise slowly the control box to the front then fix it with 2 supplied screws (M4 1 pcs).
  10. Connect the cable of carriage to the machine with fixed screw.
  11. Install the arm for tubular embroidery. Please refer to (page 6-1) "Installing and removing the frame base".  
Or, install the cap frame for the cap embroidery.  
Please refer to (page 7-1) "Installing and removing the cap drive frame".
  12. Insert built-in stylus into the holder (slot) of control box.
- When taking the machine apart in case of packing, the process is opposite of assembling the machine. Please do exactly the opposite way of assembling.
  - When packing the machine up for transportation, be sure to select the sixth needle and fix it with shipping collars on the both side of the guide bar.

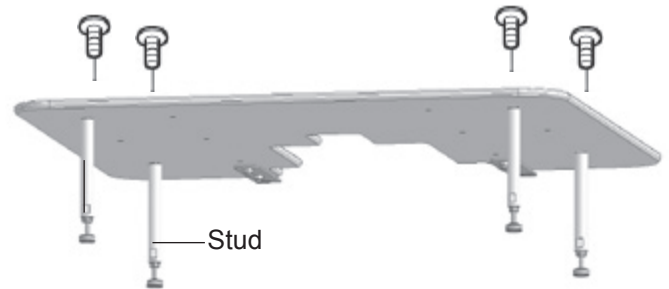


## ● Assemble table (Option)

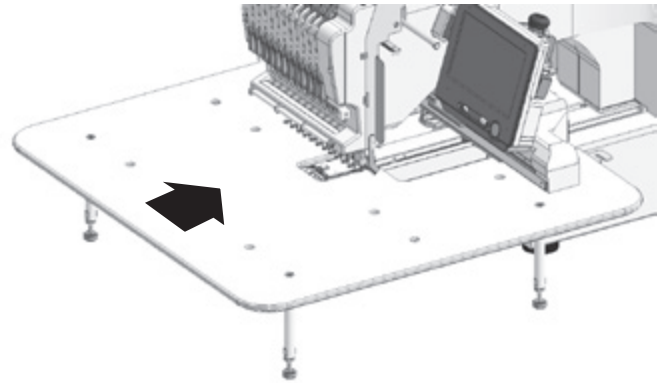
Installing the Table.

When using the border frame, it is necessary to set the table in advance.

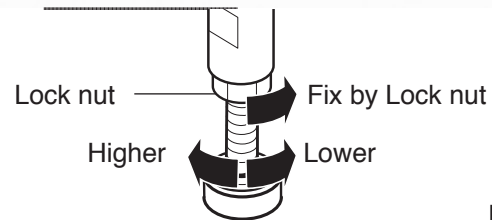
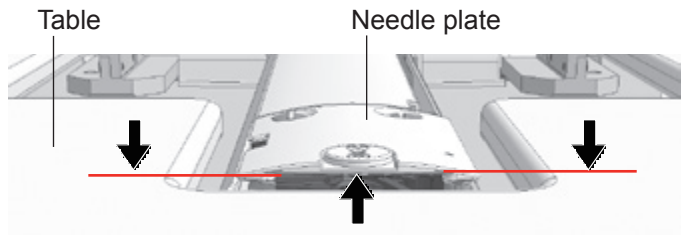
1. Attach the stud (4 places) with the included screws (M6x16).



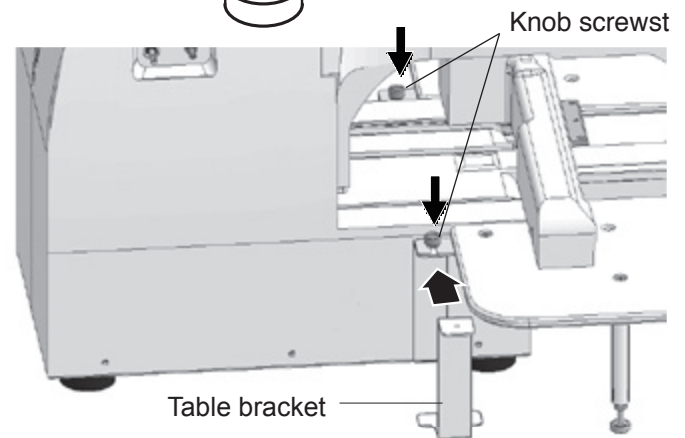
2. Place the table so that the bed of the machine fits in the recess of the table and push it in the direction of the arrow until it hits the machine.



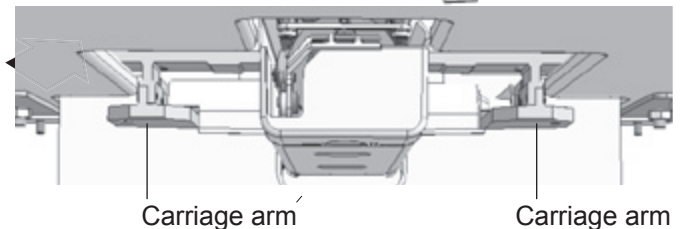
3. Adjust the stud adjuster so that the bottom of the needle plate and the top of the table are at the same height. Also, adjust the table so that it is horizontal.



4. Tight knob screws (2 pieces) for fix the Table bracket.



Carriage arm is not touching to table.



- Please reverse procedure when remove the table.

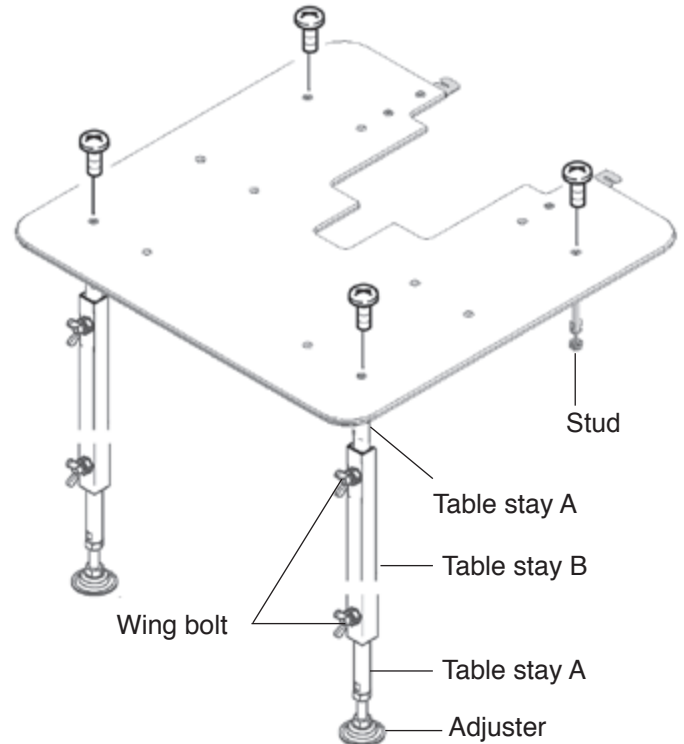
## ● Assemble table stay and table (Option)

Installing the table using the table stay.

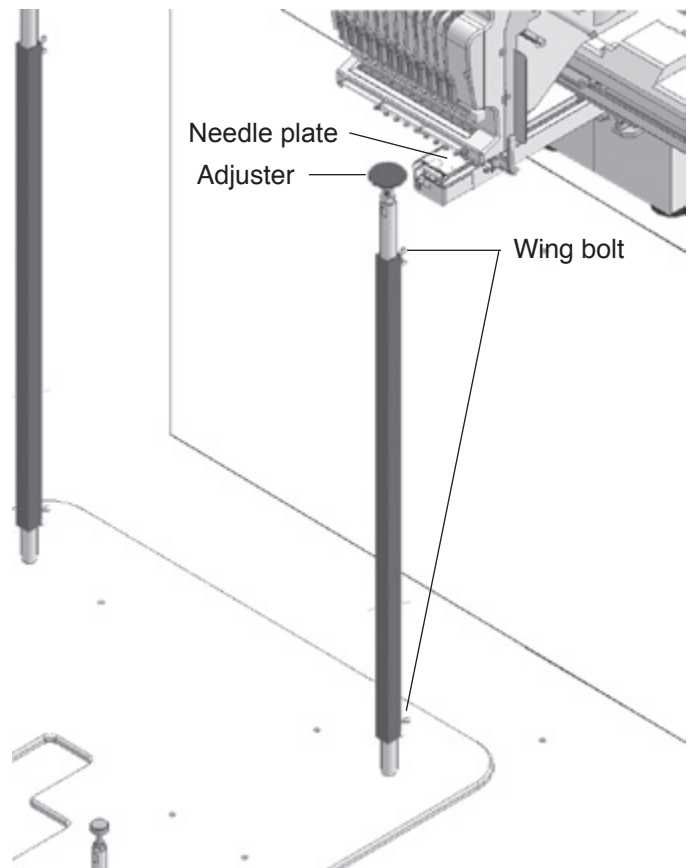
When fixing the table, use the table stays to place the front of the table on the floor.

When using the border frame, it is necessary to set the table in advance.

1. Attach the studs (2 pieces) to the rear side of the table with the provided screws (M6x16). Attach the table stay A to the front side of the table with the provided screw (M6x16), attach the table stay B with the Wing bolt, and install the table stay A with the adjuster with the Wing bolt.



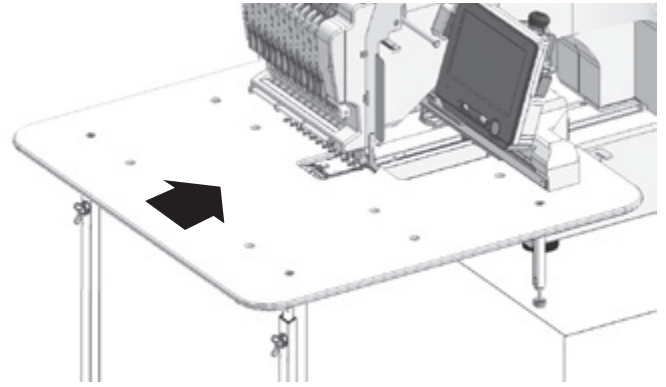
2. Place the table with studs and table stay upside down in front of the embroidery machine. At this time, loosen and adjust the wing bolt so that the height of the adjuster is about the same as the bottom surface of the needle plate.



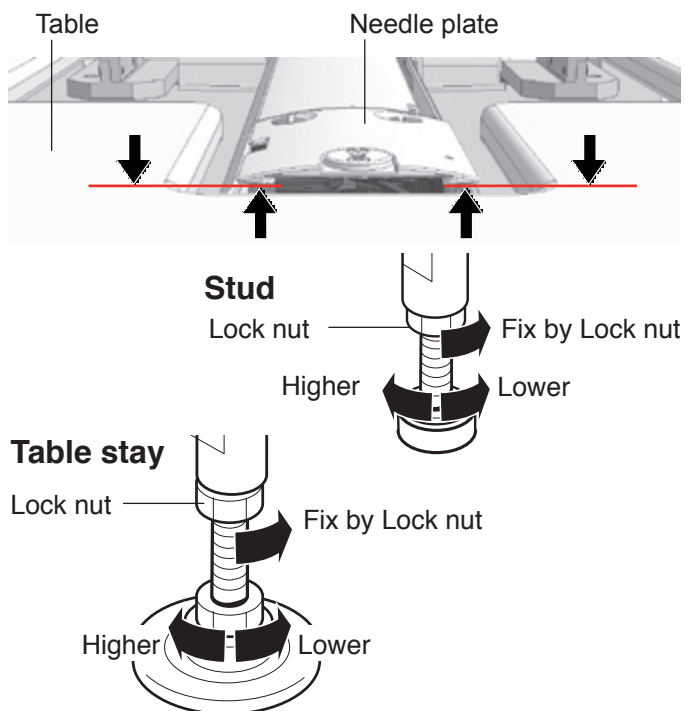
# SETTING UP THE MACHINE

## 2-4d

3. Place the table so that the bed of the machine fits in the recess of the table and push it in the direction of the arrow until it hits the machine.

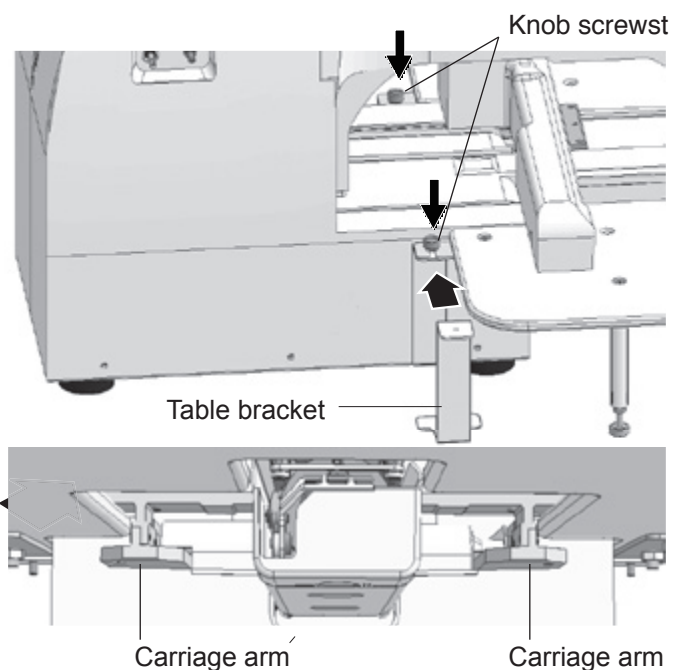


4. Adjust the stud adjuster so that the bottom of the needle plate and the top of the table are at the same height. Also, adjust the table so that it is horizontal.



5. Tight knob screws (2 pieces) for fix the Table bracket.

Carriage arm is not touching to table.

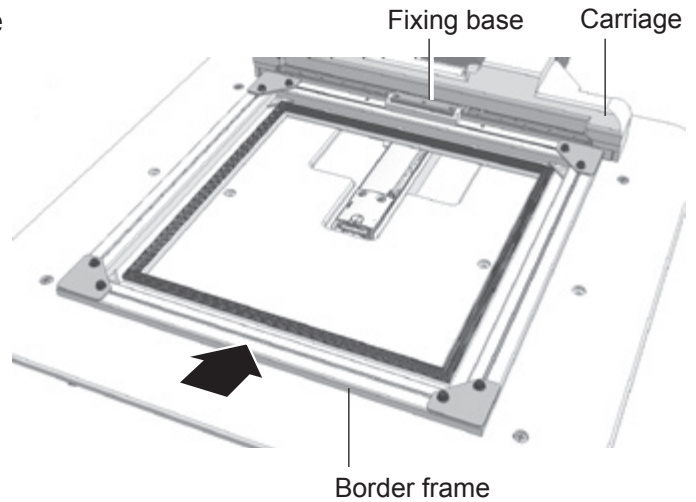


- Please reverse procedure when remove the table stay and table.

## ● Assemble border frame (Option)

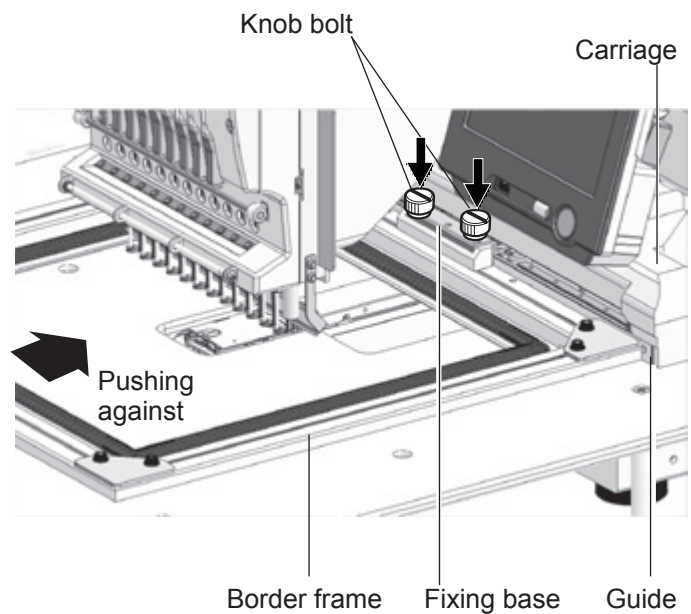
When using the border frame, it is necessary to attach the table in advance.  2-4b, 2-4c

1. Push in the direction of the arrow so that the fixing base of the border frame fits under the fixing base of the X carriage.



2. Place the border frame on the carriage guide and tighten the knob bolt completely.

Move the frame base right or left when it is hard to tighten the knob bolts



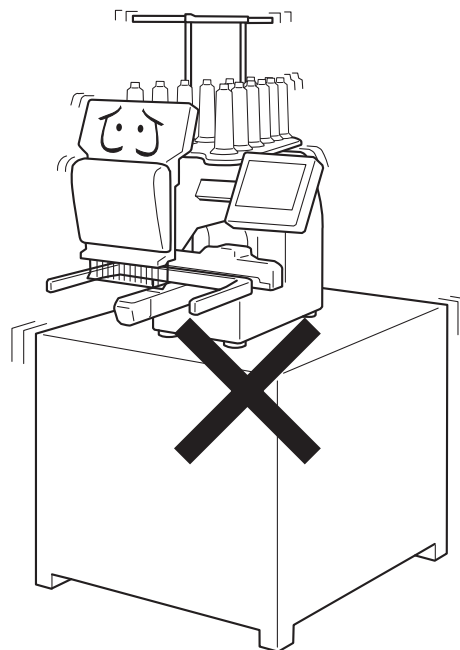
- Please reverse procedure when remove the border frame.

## ● Machine installation

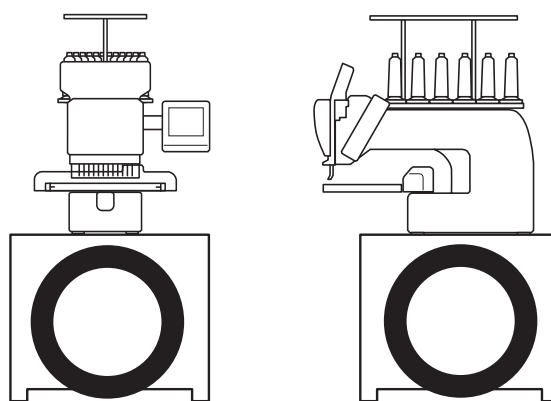
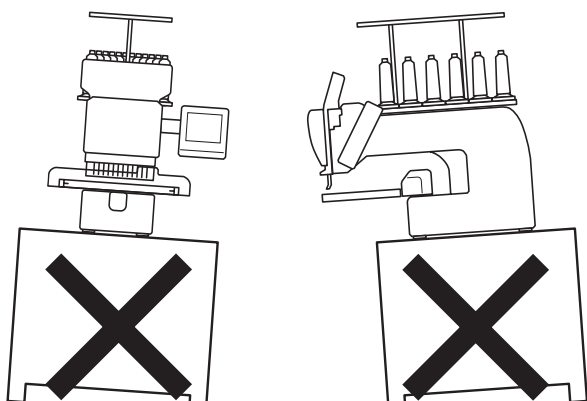
1. Please use a stout table to set the machine on.

Please check for any shaking or excessive vibrating of the machine table when the machine is running.

If you have a problem, Please use a stronger table for the machine.

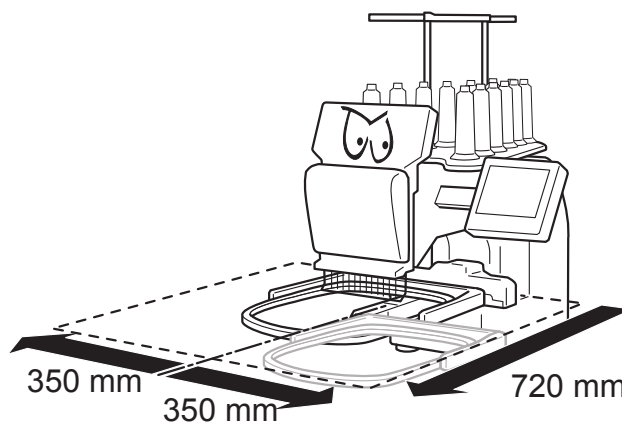


2. Please sit the machine level on the table.



3. Please be sure you have this much room around your machine for it to move.

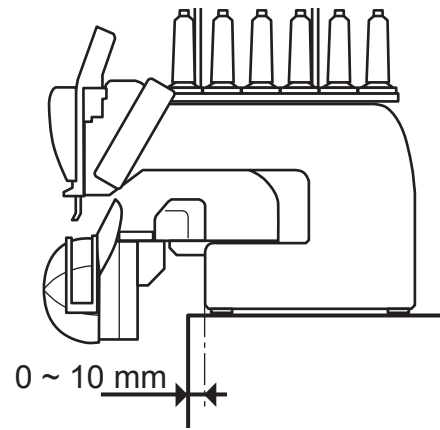
It is possible for the embroidery frame to hit you and cause injury.





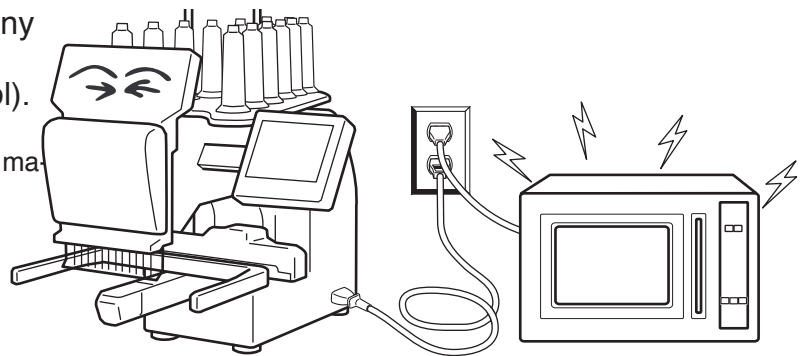
4. Please be sure you have this much room around your cap drive for it to move.

Please machine on the table positioning like right side drawing.



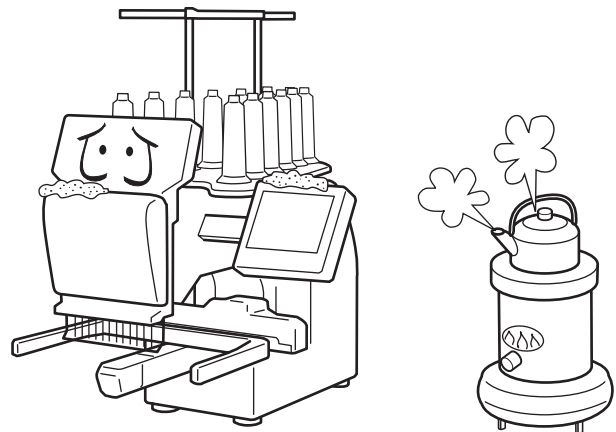
5. Please do not sit the machine near any kind of other electric equipment (Examples: Microwave or electric tool).

Has possible to wrong movement of the machine.



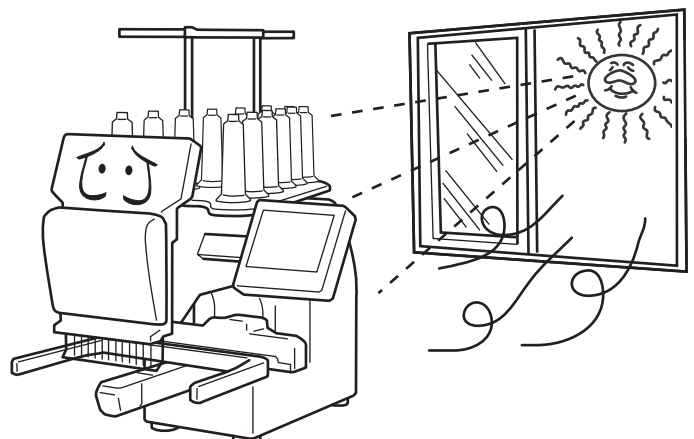
6. Please keep away from dusty and high moisture environments.

Has case of rusting or damaging.



7. Please do not sit the machine in direct sunshine or windy locations.

Has case of rusting or damaging.



## ● Grounding instruction (for type of 120V)

This product must be grounded. In the event of malfunction or breakdown, grounding provides a path of least resistance for electric current to reduce the risk of electric shock. This product is equipped with a cord having an equipment-grounding conductor and a grounding plug. The plug must be plugged into an appropriate outlet that is properly installed and grounded in accordance with all local codes and ordinances.

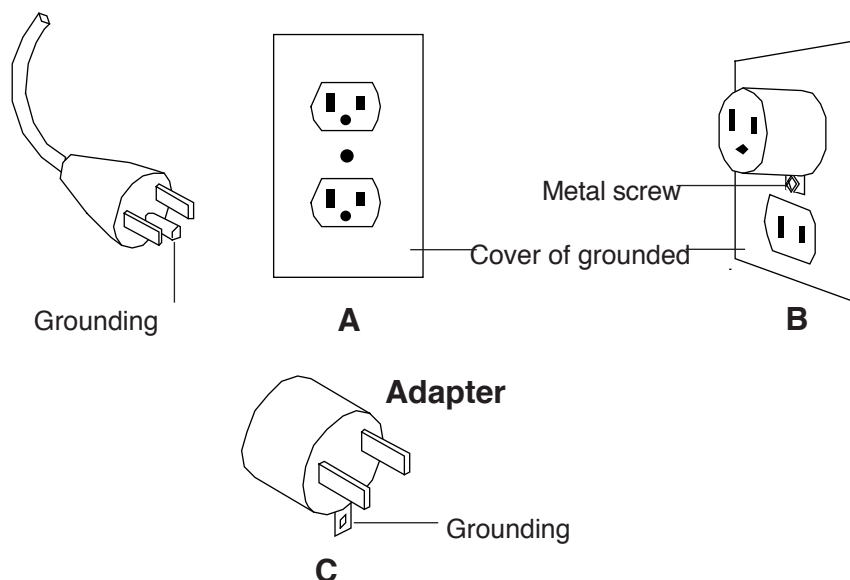
**⚠ DANGER** – Improper connection of the equipment-grounding conductor can result in a risk of electric shock. The conductor with insulation having an outer surface that is green with or without yellow stripes is the equipment-grounding conductor. If repair or replacement of the cord or plug is necessary, do not connect the equipment-grounding conductor to a live terminal.

Check with a qualified electrician or serviceman if the grounding instructions are not completely understood, or if in doubt as to whether the product is properly grounded.

Do not modify the plug provided with the product – if it will not fit the outlet, have a proper outlet installed by a qualified electrician.

This product is for use on a nominal 120 V circuit, and has a grounding plug that looks like the plug illustrated in sketch A in Figure. A temporary adaptor, which looks like the adaptor illustrated in sketches B and C, may be used to connect this plug to a 2-pole receptacle as shown in sketch B if a properly grounded outlet is not available. The temporary adaptor should be used only until a properly grounded outlet can be installed by a qualified electrician. The green colored rigid ear, lug, and the like, extending from the adaptor must be connected to a permanent ground such as a properly grounded outlet box cover. Whenever the adaptor is used, it must be held in place by the metal screw.

### Grounding methods

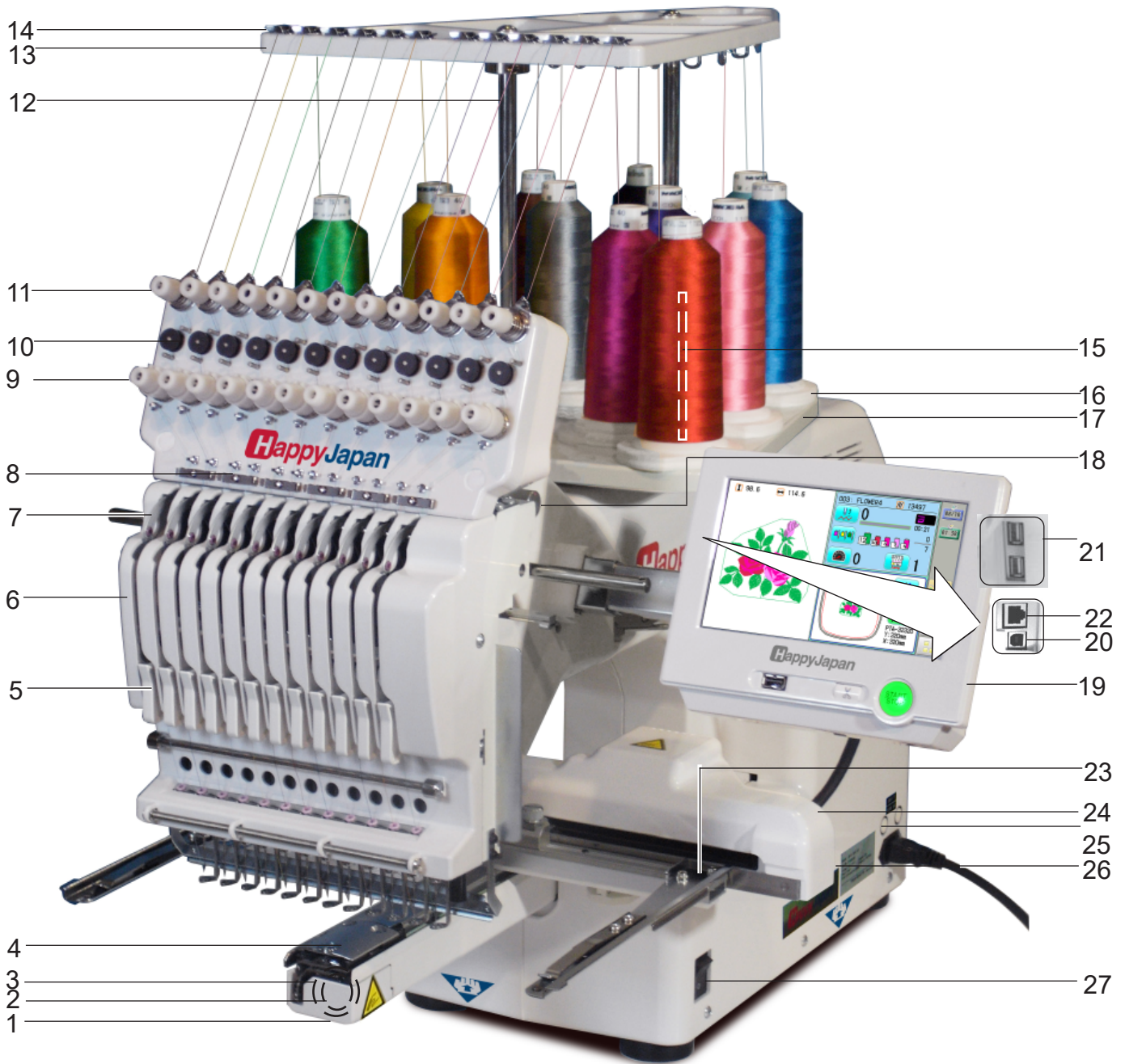




## ● Disposal of a battery



A battery is had built-in to this embroidery machine.

When you dispose of a battery, according to each country or a method determined in each area, please dispose appropriately.

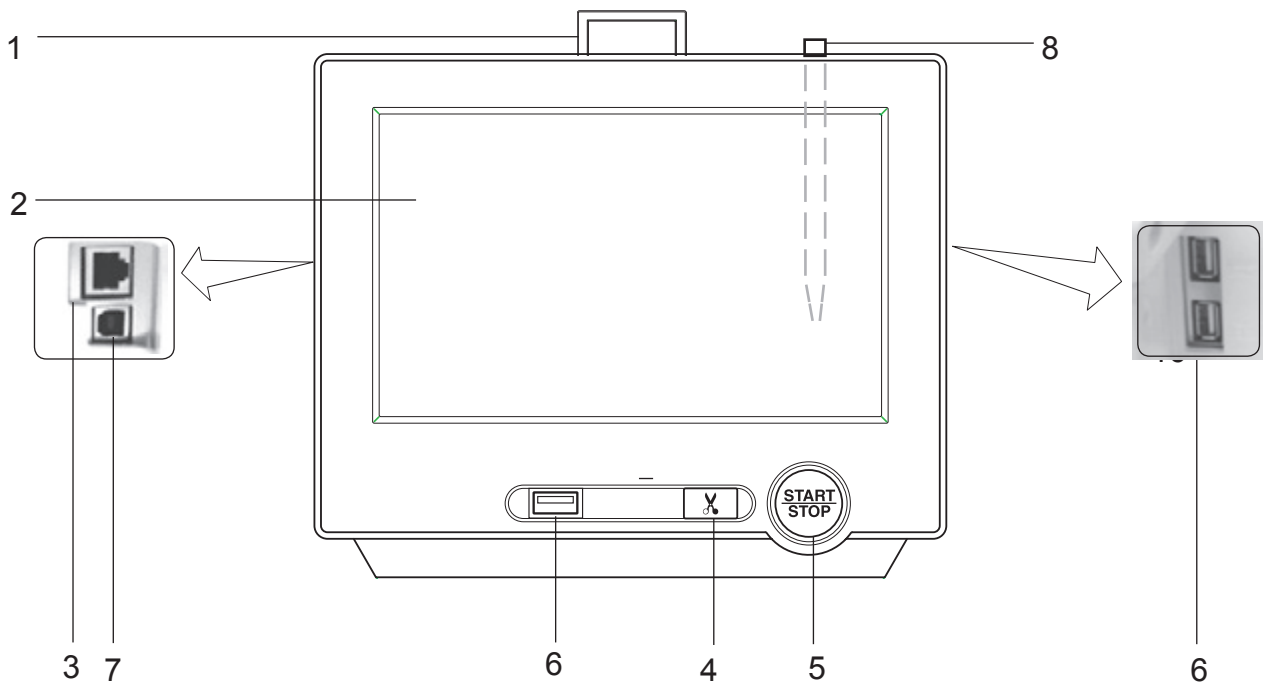


- |                          |   |  |
|--------------------------|---|--|
| 1. Hook cover            | 17. Thread stand                        | 24. Carriage   |
| 2. Bobbin case           | 18. Needle bar selection knob           | 25. Fuse (6A)  |
| 3. Hook                  | 19. Control box                         | 26. Terminal box   |
| 4. Needle plate          | 20. USB port<br>(Standard-B receptacle) | 27. Power switch   |
| 5. Thread check spring   | 21. USB port<br>(Standard-A receptacle) | When turning off the machine, be<br>sure to press  (Power off)<br>key on the control box to turn off<br>the machine.  5-1c |
| 6. Take-up lever cover   | 22. LAN port                            |  |
| 7. Take-up lever         | 23. Frame base                          |  |
| 8. Lower rectifier       |   |  |
| 9. Thread tension        |   |  |
| 10. Detecting roller     |   |  |
| 11. Minor thread tension |   |  |
| 12. Thread guide support |   |  |
| 13. Thread guide         |   |  |
| 14. Upper rectifier      |   |  |
| 15. Thread stand pin     |   |  |
| 16. Thread stand felt    |   |  |

### CAUTION

Do not charge your smartphone etc via the USB port (Standard-A receptacle).  
If you make a mistake, you can not operate the control box or can not read from the USB port.  
In this case disconnect the USB cord and turn it back on once.

## CONTROL BOX

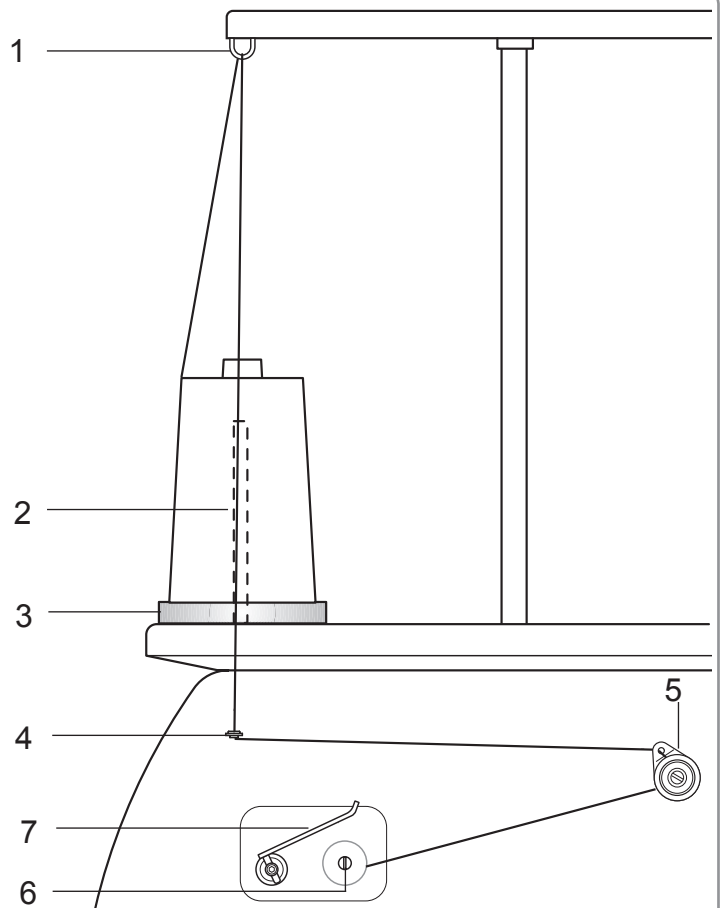


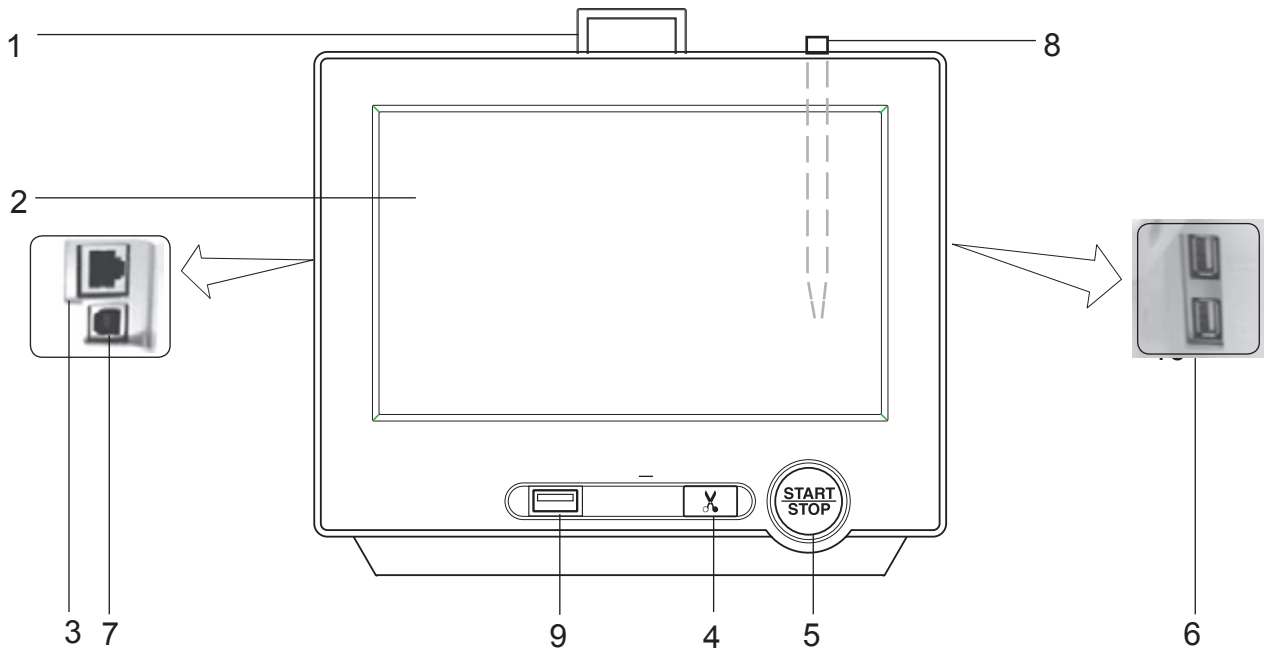
- 1. Emergency stop button
- 2. Display (L.C.D.)
- 3. LAN port
- 4. Thread cut button
- 5. Start/Stop button

- 6. USB port (Standard-A receptacle)
- 7. USB port (Standard-B receptacle)
- 8. Stylus

## BOBBIN WINDING

- 1. Upper Thread guide
- 2. Thread stand pin
- 3. Thread stand felt
- 4. Thread guide
- 5. Thread tension
- 6. Spindle
- 7. Lever





## CAUTION

The touch screen can be operated by finger, but in some cases sensitivity of the screen will be affected by condition of the finger. In such cases, please use the fingertip or built-in stylus to hit small touch targets.

### 1. Emergency stop button

When pressed, the power is switched off and the machine stops immediately. The emergency button locks when pressed. To unlock, turn the button to the right, or pull it up. Use this button only for emergency.





Green ..... Machine ready to sew. Main menu also accessible by pressing MENU, which causes menu to display.  
 Blinking red.. Indicates the upper thread has broken or the Bobbin thread has run out.  
 Red..... Machine is running.  
 Orange ..... Machine has detected an error. An error number will be shown on the Display. [P](#) 24-1

### 2. Display (Touch screen)

Shows the embroidery design name, the number of the current needle and other machine generated messages. Menu and keys in the display can be operated with a finger or built-in stylus.

### 6. USB port (Standard-A receptacle)

 USB flash drive socket.

 USB mouse socket.

Menu and keys in the display can be operated with a commercial USB mouse. Press right mouse button to show a mouse pointer in the display.

### 3. LAN port

You can connect PC with a LAN.

### 4. Thread trim button

The Machine will cut the upper and lower thread when this button is pressed. In case you press and keep (around 2 sec.), you can cut only bobbin thread.

### 7. USB port (Standard-B receptacle)

Use this port to connect the machine with PC via USB.



## CAUTION: To prevent accidents.

If you Press thread trim button, the needle will penetrate the fabric. Please keep your hands clear for your safety.

### 5. Start/Stop button

This button starts the machine. When pressed, while the machine is running, the machine will stop.

### 8. Stylus

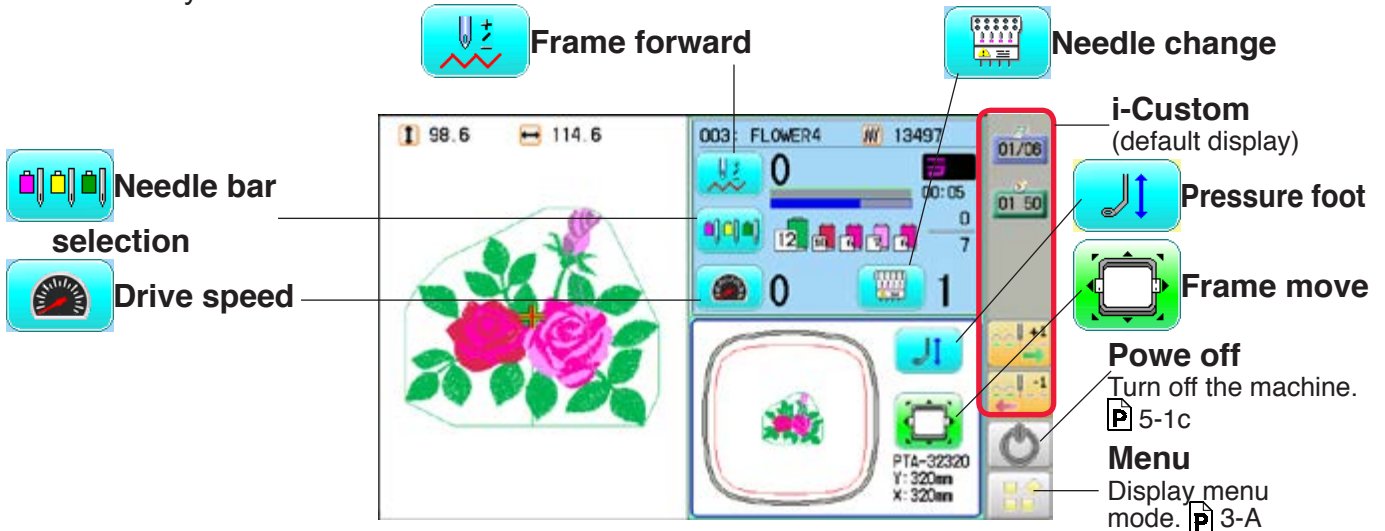
Stylus can be used for pressing menu and keys in place of fingers. Most operation can be done by fingers. Stylus is required for some operation such as calibration for the touch panel LCD. [P](#) 18-6 Insert a stylus into the holder (slot) of control box when not used to prevent loss of the stylus.

### 9. USB port (Standard-A receptacle)

USB flash drive socket.

## Drive key

The each key menu will be shown.



### Drive speed

Control embroidery speed.  
The speed can be controlled while embroidering.



#### Speed control

Press the + button to increase the machine sewing speed and the - button to lower the machine speed. is displayed on the LCD display.



#### Low speed operation (OFF state)

Press the button to turn "ON" state.



#### Low speed operation (ON state)

The drive speed will be reduced to "200 rpm".  
Press the button to turn "OFF" state.



#### Speed setting by needle (OFF state)

Press the button to turn "ON" state. P 3-9d



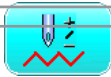
#### Speed setting by needle (ON state)

Press the button to turn "OFF" state. P 3-9d



### Needle bar selection P 5-E

For each color change in a given pattern, the needle number loaded with the correct color thread is assigned by the operator.



### Frame forward

This creates direct designations to the position and data to the designated sewing position.



#### Piece

If "Repeat" is set, this allows the frame to move to the beginning of any piece at will.



#### Change (Color position)

This moves the frame to the beginning of any Color change number at will beginning of color.



#### Stitch (Number of stitches)

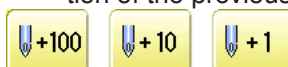
This moves the frame to any stitch at will.



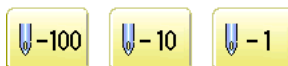
#### Color position forward



Move the frame to the beginning embroidery position of the previous or later color position number



#### Stitch number forward



Move the frame forward or backward by the stitch number displayed in each button.



## Needle change

Change



Change the needle bar directly to the indicated needle number on the button.



Change

Move the sewing head to the adjacent needle in the direction of the arrows.

Although the needle bar setting has been done, needle bar setting is changed and pressed

OK

, following dialogue will be displayed.

Needle bar has been changed.  
Reflect on the color change setting?

YES

NO

YES

Needle bar setting will be changed and the display will return to Drive mode.

NO

Needle bar setting will not be changed and the display will return to Drive mode.





Pointer

Turn on and off the laser pointer.  
Laser pointer is located at right side of needle no.1.(Needle no.0 position).  
When laser pointer is turned on, moving head moves to needle no.0 position and radiates.



Pointer (Auto)

By pressing the  long time,  "Auto" will appear.

Laser pointer turned on automatically, after the color change stop function or embroidery finished.

To release this function, press the key long time.



Pressure foot

You can raise or lower the presser foot .



Jump (Off)

The machine can embroider.



Jump (On)

Machine becomes jump and the machine doesn't embroider.

## i-Custom 22-1

The following display and key icons are set as default. You can place other frequently used icons freely on the right side of Drive mode screen.



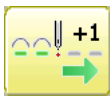
**Calendar**

Current year, month date is displayed.




**Clock**

Current time is displayed.



**Stitch number forward**

Move the frame forward or backward by the one stitch.

In addition, "Key lock" function can be used by setting.  15-2

When the key is pressed continuously, the "Key lock" function is activated and the frame will move continuously even the finger is released from the key.

When the key is pressed much longer, the step of "Stitch number forward" will be changed from one stitch to 10 stitches.

When you stop it, press  (Start/Stop button).



**Frame move**

Selection the way of frame movement and Move frame.



**Frame change**  3-8a

Change the frame to be used.



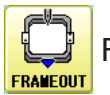
**Design centering**

Move design to the center of frame.





**Center**

Moves the embroidery frame to the center automatically.



**Frame out**

Move frame to the front position which was set on the Machine setting ( 15-1b) before.

Press  (Position) to return the frame to the

original position before frame out position. It is convenience if hand work is required in the middle of embroider process.



**Position**

When sewing is interrupted in the middle of a design, this returns the frame to current sewing position regardless of where frame may have been moved with the arrow keys after interrupt. target design.



**Original point return**

This returns the frame to \*pattern origin point. After performing this action once, repeating this again will cause the frame to return to the previous position.



**Origin registration**

Register the current frame position as origin.



**Trace**

When pressed while at the beginning of design, the embroidery frame moves following the outer edge of the design. This allows you to compare the design size and position against the frame before sewing.



**Register**

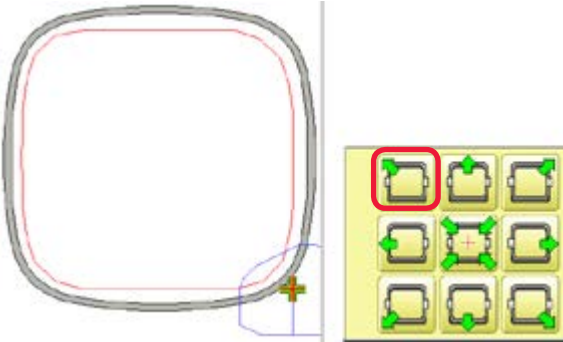
Register will restore the position of the frame to the last point before a power failure even if the point of origin or the pattern itself were changed.





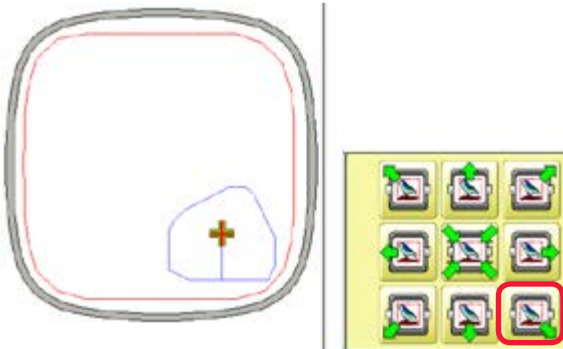
## Quick move

First press this key and then the arrow key to move the frame toward the edge of the maximum embroidery area in the direction of the arrow.



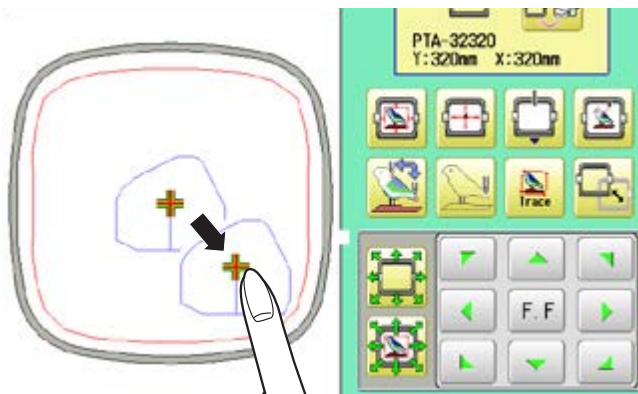
## Quick embroidery design data position move

First press this key and then the arrow key to move the frame where the design data can be embroidered at the edge in the direction of the arrow.



## Frame move key

The frame moves toward direction of the arrow



You can move the embroidery frame by pressing desired position on the screen.



## Pointer (Option)

Turn on and off the laser pointer.



## Position alignment by defining 2 points 9-8

machine automatically sets angle and embroidery only by defining 2 points.



## X Direction frame move



## Y Direction frame move

The frame can be moved with specified distance along X axis or Y axis. (Unit: mm)  
The function allows you to move the frame precisely with a pitch of 0.1mm.



Select the number, and press .

The frame will move specified distance.

ESC

Changing is cancelled.

CLR

Numbers are deleted.



## Pressure foot

You can raise or lower the presser foot .

F.F

## Fast move (OFF state)

Press the button to turn "ON" state.

F.FF

## Fast move (ON state)

Press this key one time to move the frame faster toward the direction of the arrow.  
Press the button to turn "OFF" state.

F.FF

## Fast move speed setting (High)

F.FF

## Fast move speed setting (Middle)

F.FF

## Fast move speed setting (Low)

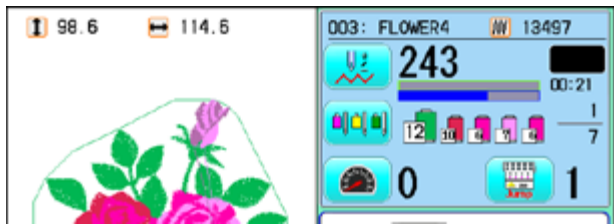
The speed of "Fast move" can be adjusted.

## Speed setting by needle (ON state)

Embroidery speed can be set by needle.

If speed by needle exceeds the speed set at Drive speed setting, the value of speed turns gray and speed by the needle is applied to the speed set at Drive speed setting.

You can be set up taking the following steps.



1. Press






2. Press

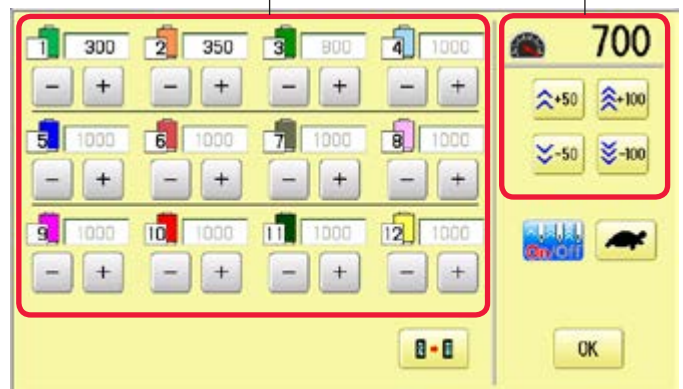


Speed setting by needle

Drive speed setting

3. Change the setting on the needle number you would like to change with  .

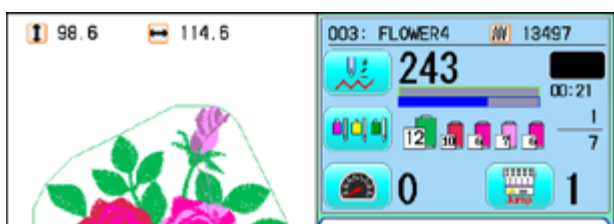
Press  when returning the setting on all the needle numbers to maximum.



4. Press



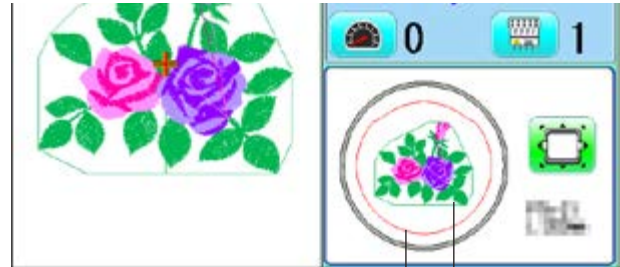
The screen returns to Drive mode.





## Frame change

Change the frame according to the pattern to embroider.  
This helps to confirm positioning between the embroidery area and the pattern.













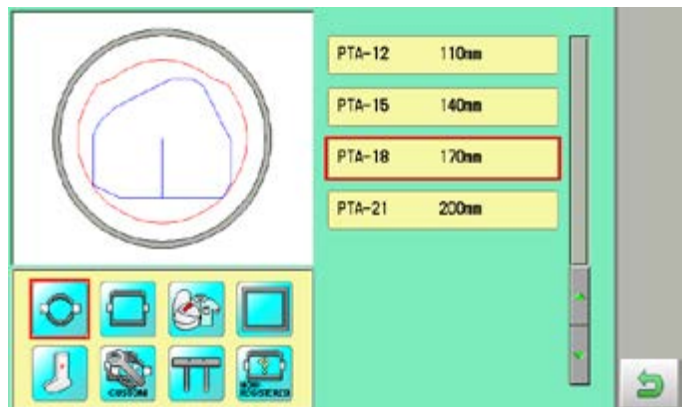
Embroidery area    Pattern

1. Press  .

2. Press  .

3. Select the type or size of the frame.

-  Tubular round frame
-  Tubular square frame, One touch frame
-  Cap and One-point frame
-  Square clamp frame, Border frame
-  Sock frame
-  User-defined frame  13-A
-  Special frame
-  Non registered  13-J

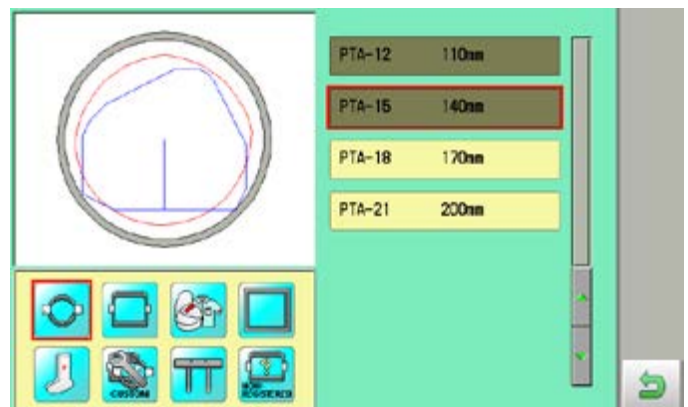


### Frame recommend func. 15-2

If the setting of “Frame recommend func.” on “OPTION” is set to “YES”, the frame display becomes gray when the embroidery area of frame is smaller than the pattern size.

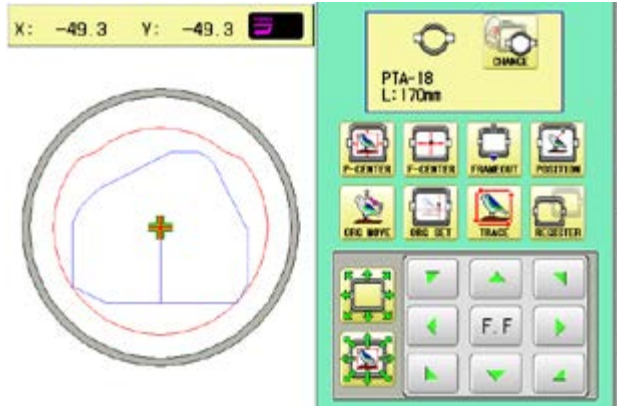
You can select the frame, but a warning may be displayed when you start embroidery.

 3-8b

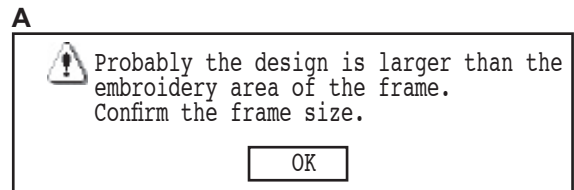


4. Press .

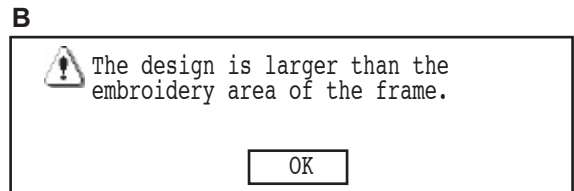
At this time, a warning of A or B may be displayed.





**A**  
When placing the center of the pattern in the center of the embroidery area, it may not fit the embroidery area.




**B**  
The pattern does not fit into the embroidery area. Return to step 2. and select a large frame.



Press  and the warning will disappear.


5. Press  to return to Drive mode.

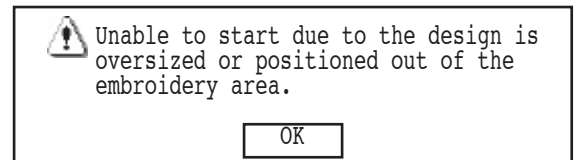
6. Press  if you want to start embroidering without tracing.


At this time, the following warning may be displayed.



The position of the current pattern does not fit into the embroidery range, or there is not much area. Please select a large frame or change the position of the pattern.

 6-4, 7-B



Press  and the warning will disappear.

### CAUTION

Warnings are not displayed when Sock frame, Special frame, User-defined frame is selected, or machine in QUEUE.

## Display example

When beginning an embroidery

Needle number and color

Mark for color

Mark for frame out

Status

Top

This indicates that the machine is ready to start sewing from the "top" memory position of the pattern.

Frame out

This indicates that a frame out is occurring.

\*Color change number

Currently-selected needle

Selected frame

Name of selected pattern

Memory # of selected pattern

Stitches of pattern

Size of pattern and distance

98.6 114.6

003: FLOWER4 13497

0 00:21

12 0 7

0 1

PTA-32320  
Y: 320mm  
X: 320mm

Heigh

Width

## Machine stopped during embroidering

Remaining amount of bobbin thread. P 9-Cb

When "Bobbin thread alarm" is set, bar graph will be appeared.

Bar graph

Number of stitches sewn up to now

243

00:21

1 7

0 1

PTA-32320  
Y: 320mm  
X: 320mm

Remaining embroidery time, Hour : Minute. When over 24 hours, Day(s).

Current \*Color change number

Shift to left when color

Pointer indicates the position of actual stitch point.

Pointer

If a needle number is not assigned to a Color change number, the default color will be assigned automatically.

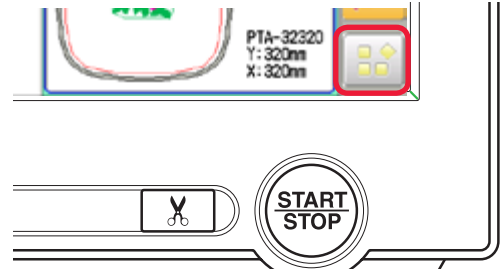
## Display if the machine has no design in memory


HappyJapan


0 1

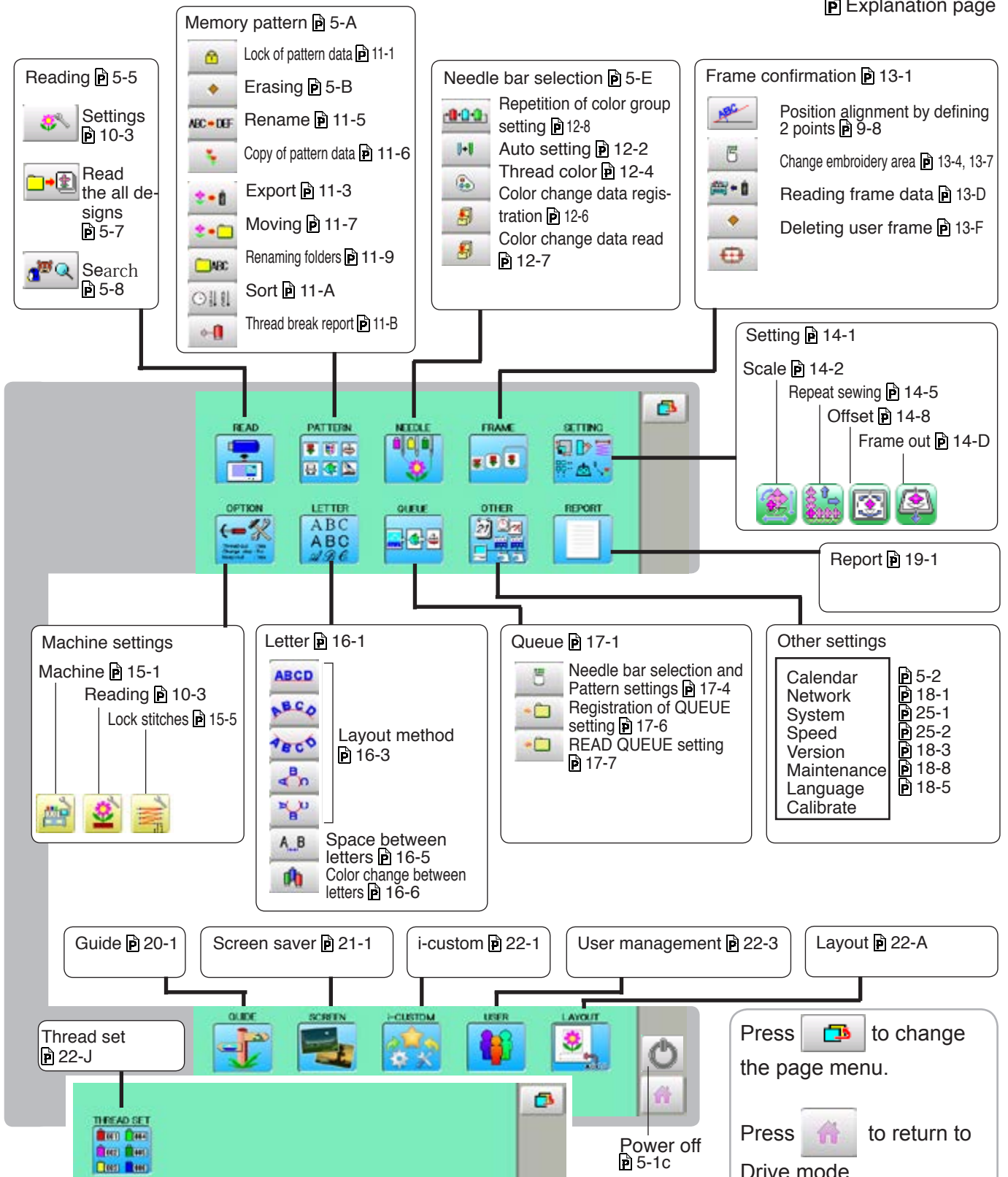
Selected frame

The diagram below describes the layout functions accessed from the main menu.



The main menu is accessed by pressing .


 Explanation page



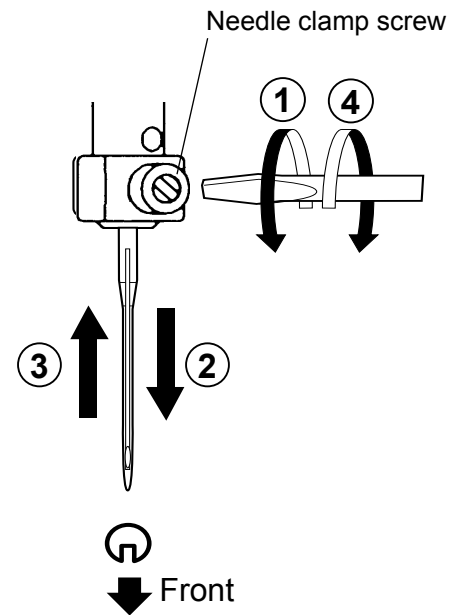
# INSERTING A NEEDLE

# 4-1

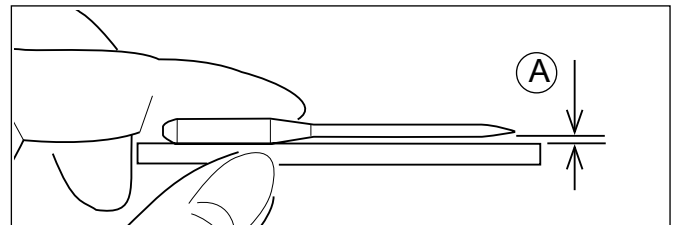
Select a needle of the right type. See the following “SELECT THREADS”.

 **CAUTION: To prevent accidents.**  
Turn off the power before removing the needle.

1. Loosen the needle clamp screw slightly with the screwdriver.
2. Remove the needle.
3. Insert a new needle into the needle clamp with push it up as far as it will go keeping the slotted side of the needle in front.
4. Tighten the needle clamp screw with the screwdriver.



- A. Do not use a bent or blunt needle.  
Place the needle on a flat surface and check for straightness.



## About needle

Please select needles by type of material .

Normally, We supply a DB X K5 needle as in the machine accessory kit.

TYPE	APPLICATION	Needle Size
DB X K5	For normal embroidery	9 ~ 18
DB - K23	For knit	9 ~ 12

## Relation of needle and upper thread

Please select type of needle and upper thread by flowing list.

Size		Relation of needle and upper thread			
Organ	German	Cotton #	Silk	Polyester	Rayon
# 8	# 60	100 ~ 130	140 ~ 160	150 ~ 200	50 ~ 70
9	65	70 ~ 80	100 ~ 120	130 ~ 150	70 ~ 100
10	70				
11	75	50 ~ 60	80 ~ 100	100 ~ 130	100 ~ 130
12	80				
13	85	36 ~ 40	60 ~ 70	80 ~ 100	130 ~ 150
14	90				
15	95				
16	100	30 ~ 36	50 ~ 60	60 ~ 80	150 ~ 160
17	105				
18	110	24 ~ 30	40 ~ 50	50 ~ 60	180 ~ 230

Normal embroidery field

► Normal use embroidery needle and upper thread.

Upper thread : Rayon 120 d/2 (120 denier)  
Polyester 120 d/2 (120 denier)

Needle : #11 ( DB X K5 )

► If the relationship of needle size and thread type is incorrect, it is possible to have any of the following problems.

- Thread break
- Skip stitch (Upper thread does not catch bobbin thread)
- Other stitch quality problem



## Backing

Generally, Backing is used for hooped embroidery fabric. Knit fabrics particularly require the use of embroidery backings.

Embroidery backings will allow the hoop to move the fabric more accurately, creating a more beautiful embroidery.

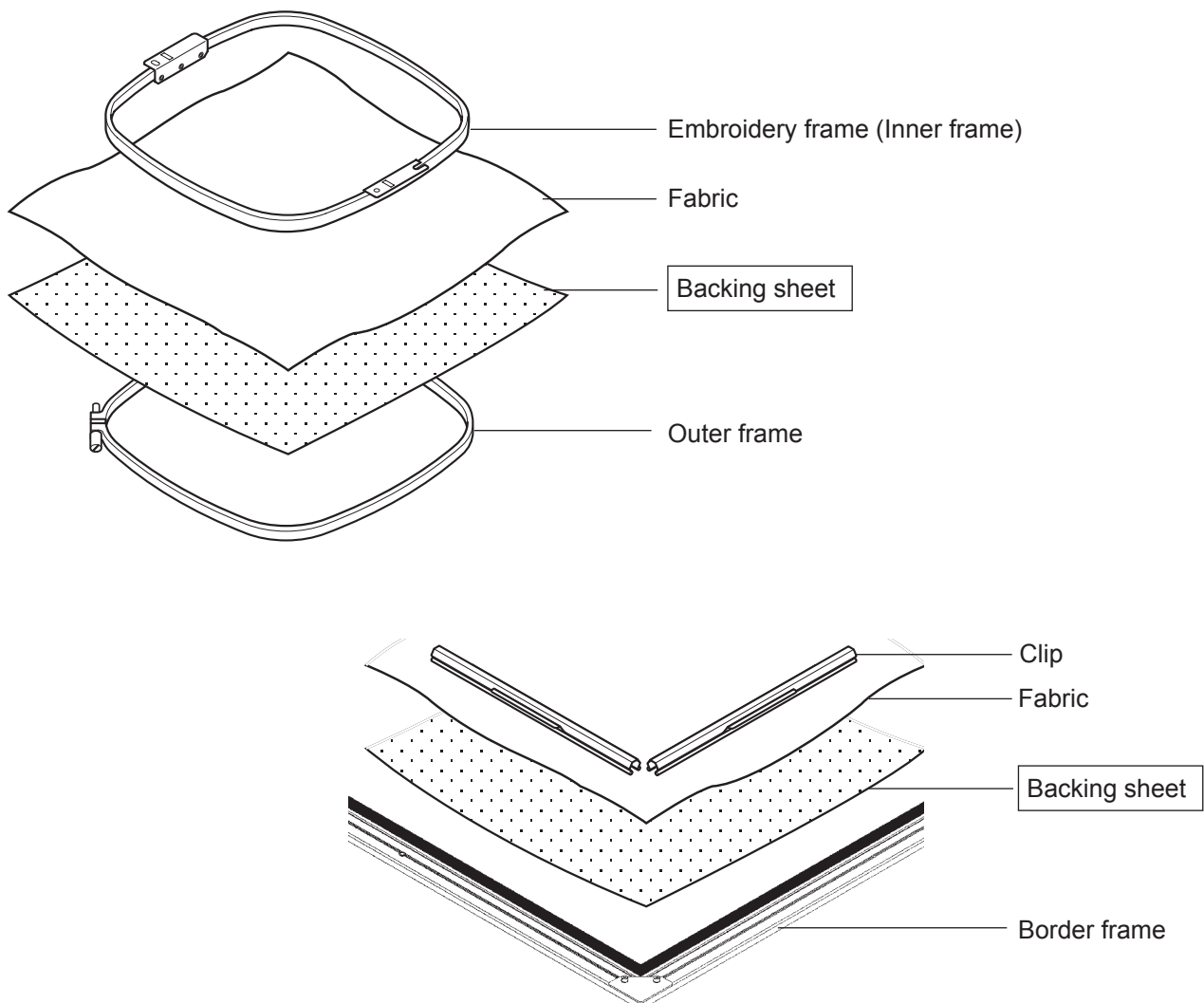
## Select backing type

Choose the thickness and number of sheets by the type of material and embroidery condition. Generally, you should consider the following items.

- Embroidery stitch quality
- Contraction or compression of fabric caused by sewing, etc.
- Stiffness of fabric

■ In case, if you sew lace and leather, you may not need backing sheet.

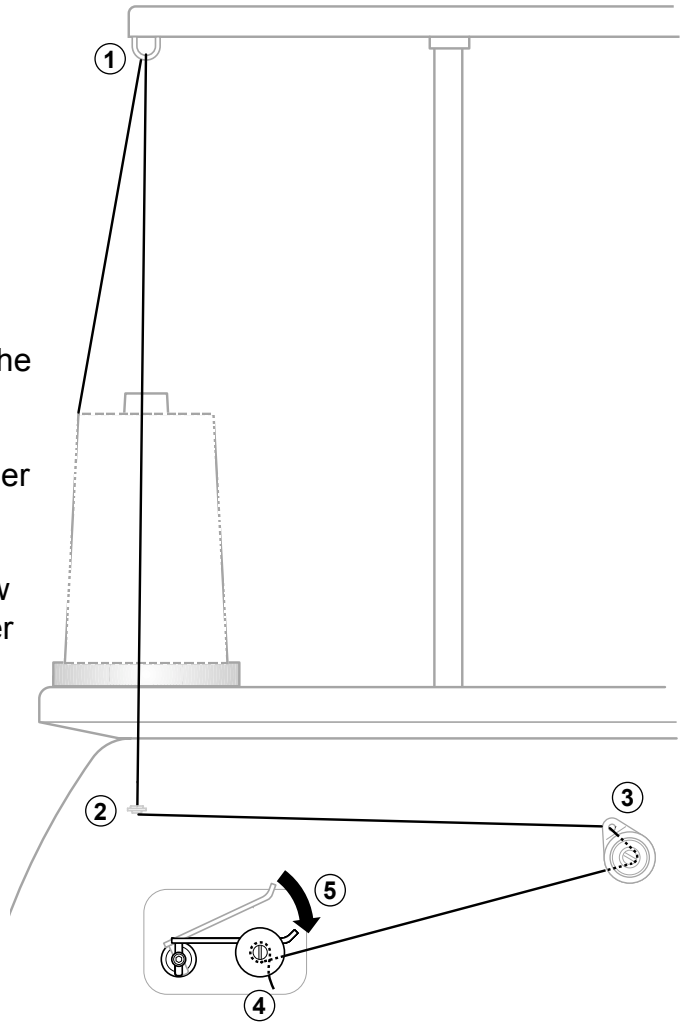
## Example of using a backing



## ● Winding the bobbin

Thread the bobbin winder as shown below:

1. Upper Thread guide
2. Thread guide
3. Thread tension – Be sure to thread through the small eye before going between the disks.
4. Bobbin (Place the bobbin on the bobbin winder spindle.)
5. Press the limit lever as indicated by the arrow to start the winder. The lever stops the winder automatically after the winding is complete.



**CAUTION: To prevent accidents.**

When lever is pressed down, the bobbin winder spindle and the bobbin start turning. Keep fingers and body away until the bobbin winder stops turning.

## Tension

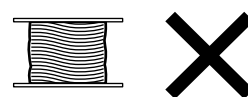
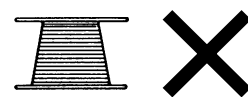
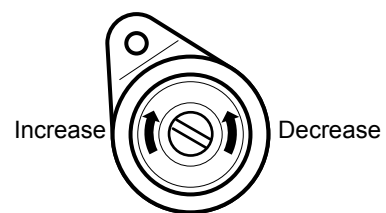
When adjusting bobbin winder tension:

- Ensure thread winds evenly on bobbin as shown.

Confirm that the bobbin is wound properly..

- Keep the tension constant while winding.

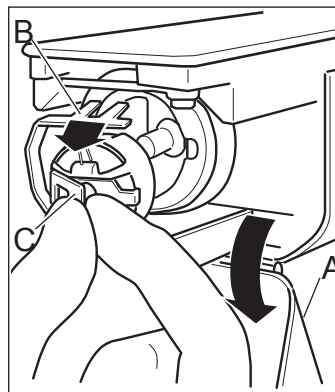
Tighten thread tension if thread winds too loosely.



**⚠ CAUTION: To prevent accidents.**  
Please watch out for the point of the rotary hook when you replace the bobbin.

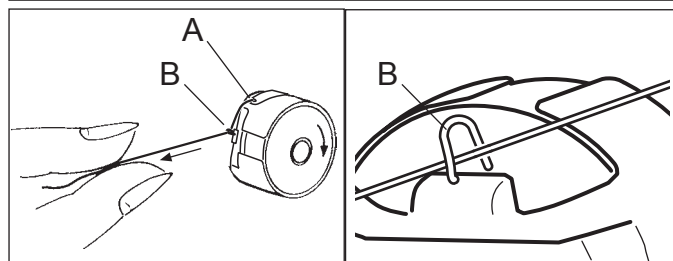
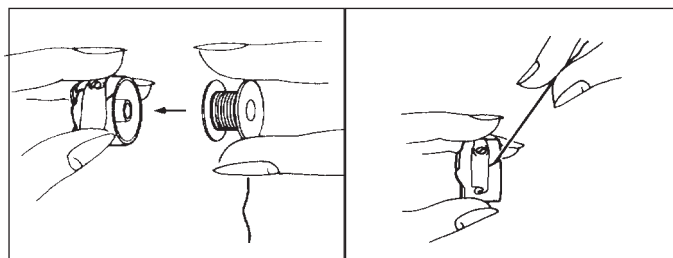
## ● Removing the bobbin case

1. Open hook cover (A) to front.
2. With opening the keeper (B) toward front, grasp bobbin case latch (C) and withdraw bobbin case from hook taking care not to damage the thread keeper.



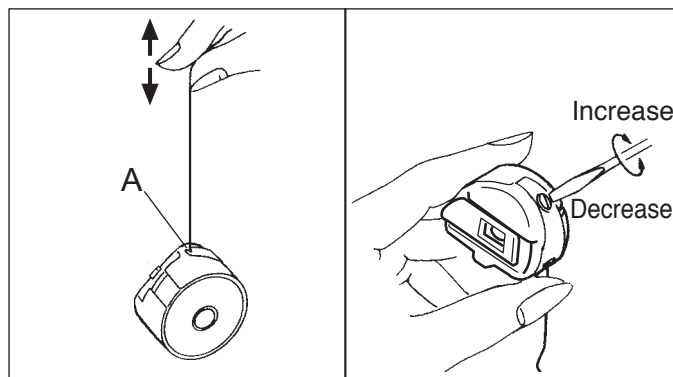
## ● Inserting the bobbin

1. Hold the bobbin case in left hand. Hold the bobbin in your right hand with thread on top leading from left to right.
2. Insert bobbin in case and draw thread up into slot in case.
3. Draw thread under tension spring (A) and wind into guide coil (B). The bobbin should turn clockwise in the case when the thread is pulled.



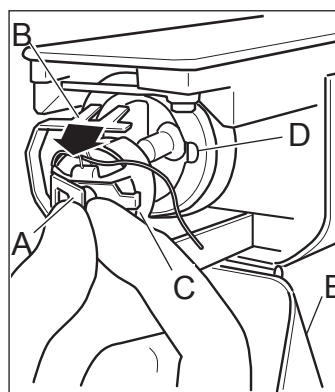
## ● Adjusting bobbin thread tension

1. Hold bobbin thread and jerk upward approx. an inch. Thread should unspool further approx. the same amount.
2. The screw on the tension spring is for adjusting bobbin tension. This adjustment is very delicate. Please turn the screw only a small amount. Only 1/8 of a turn maximum.



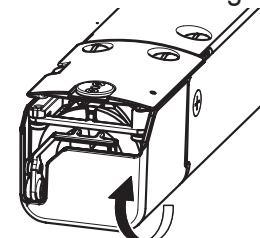
## ● Inserting the bobbin case

1. After threading bobbin in case, with opening the keeper (B) toward front, open bobbin case latch (A), grasping it in fingers as shown. Slip bobbin and case on stud (C) of rotary hook body, and press in securely. Release bobbin case latch. Press the bobbin case in to be sure it is fully seated.



2. Close hook cover (E) securely.

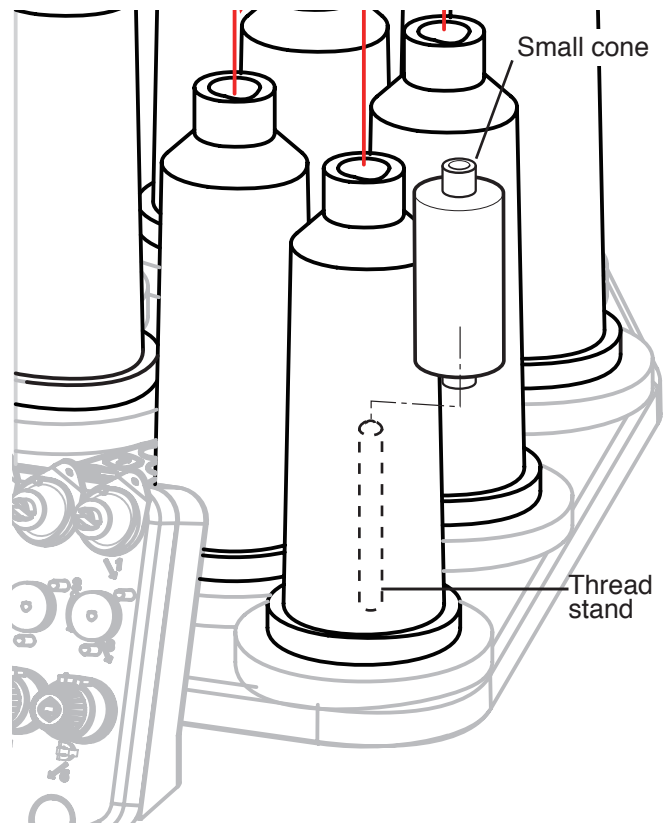
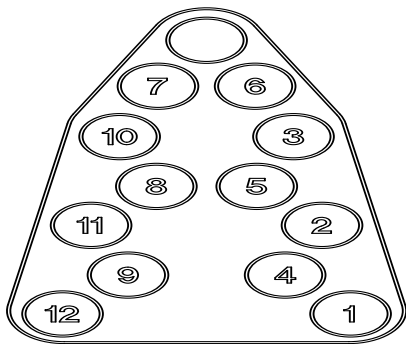
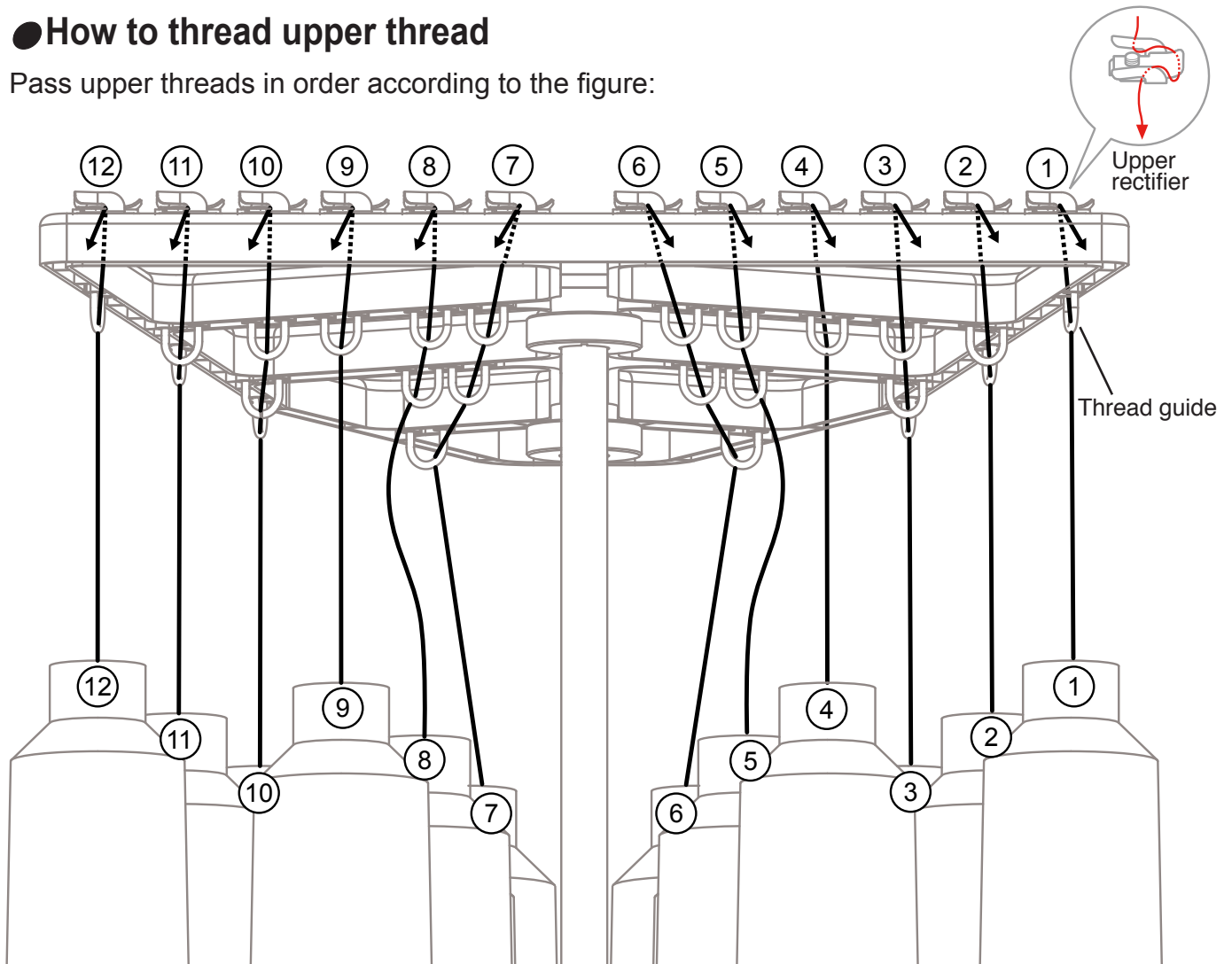
**⚠ CAUTION: To prevent accidents.**  
Keep fingers away from rotary hook while the machine is running.



■ The attached bobbin case is available only for this machine. Thread may be caught in thread guide coil if other types are used.

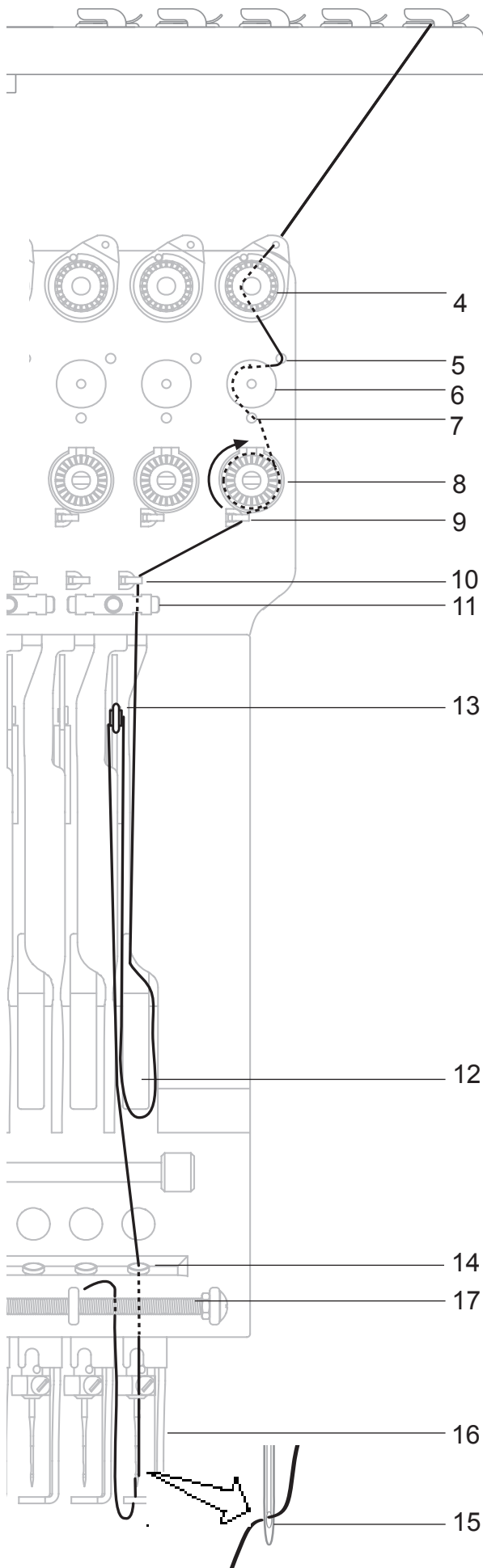
## ● How to thread upper thread

Pass upper threads in order according to the figure:



1. Thread stand  
Set thread cone on the stand.  
Small cones can also be used as shown.
2. Thread guide  
Thread through the thread guide above each thread cone.
3. Upper rectifier

Continued next page



4. Minor thread tension
5. Guide pin upper
6. Detecting roller
7. Guide pin lower
8. Thread tension  
Wind upper threads one time around rotary tension disc clock-wise.
9. Upper thread guide
10. Lower thread guide
11. Lower rectifier
12. Thread adjusting spring
13. Take-up lever
14. Thread guide plate lower
15. Needle  
Thread from front side of needle.  
Pull upper threads slowly and see that the detecting roller moves smoothly by pulling the thread downward as much as possible.
16. Pressure foot
17. Thread holding spring  
Push thread into spring.



**CAUTION: To prevent accidents.**

Please be careful of the sharp point of the needles when threading upper threads through the needle.

# HOW TO READ THESE INSTRUCTIONS and SCROLLBAR 4-8

## How to read these instruction

The instructions in this manual have been formatted as follows:

Written instructions will be provided on the left side of the page while graphics depicting the necessary steps are provided on the right.

Graphics on the far right will show the display after performing the steps indicated.


### CAUTION: To prevent accidents.

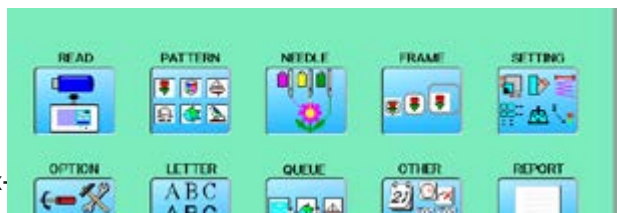
This will appear for items related to your safety.

### CAUTION: To avoid problems.

This will appear for items related to potential problems.

Order of operation





1. When the machine is stopped, press .

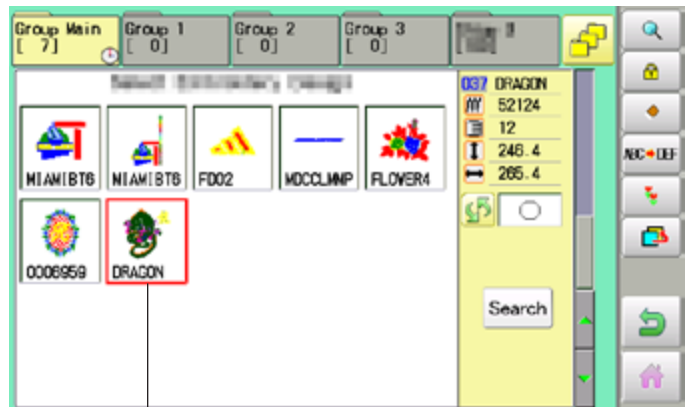


Indicates supplementary explanation regarding a given operation or action.

2. Select "PATTERN".

The display indicates the current pattern. The right side of display shows the number, name and details for the current pattern.

-  Number of stitches
-  Number of Color change number
-  Height
-  Width



Selected pattern data

AWords marked with a "\*" are explained in "EMBROIDERY TERMS" at the end of this

3. Select \*pattern data.

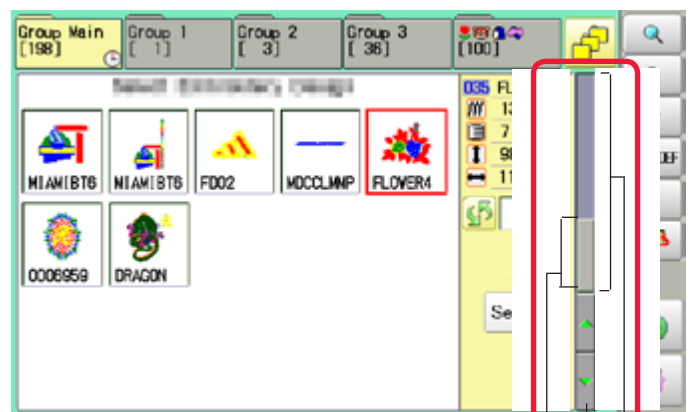
This pattern will be selected.  3-3

Operation key

This indicates an additional explanation on an operation elsewhere in the manual for more detail.

Press  to return to Menu mode.

Press  to return to Drive mode.



Display area

Arrow key

Scroll area

Scrollbar

## Scrollbar

If the data are too much to fit into display screen, you can use scrollbar.

Display area : It shows the area which is displayed.


Arrow key : You can scroll the display area to arrow marked direction.


Scroll area : It shows the whole area of the data.

You can push arbitrary point of Scroll area to display the desired location.

# DISPLAYING THE PATTERN IN SETTING MODE


# 4-9

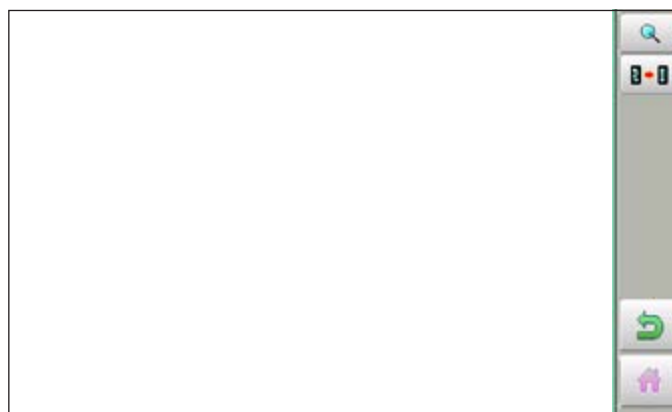
When there is  shows on the right side menu, the pattern data may be shown on the screen.

1. When the machine is stopped, press .



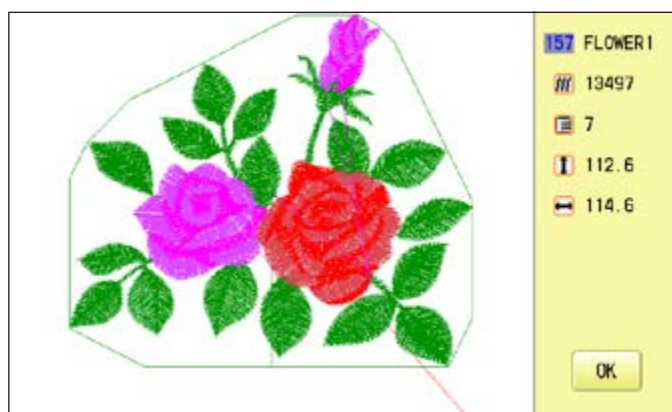
2. Select desired menu.

Icon of  will be shown in sub-menu.



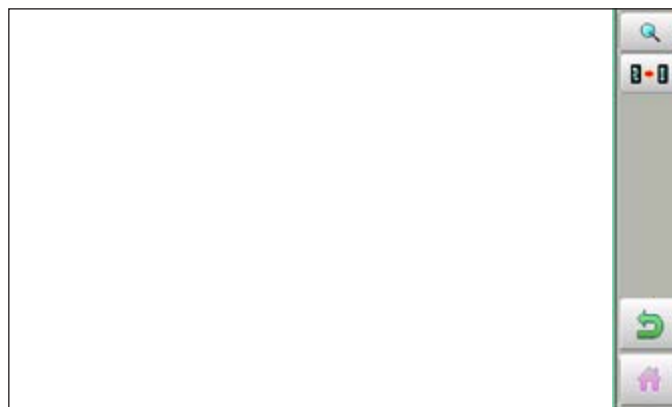
3. Press .

Illustration of the pattern selected will be displayed.  
Right side of display shows the detail information of the current pattern data.



4. Press .

The display returns to the view of Step 2.



Press  to return to Menu mode.

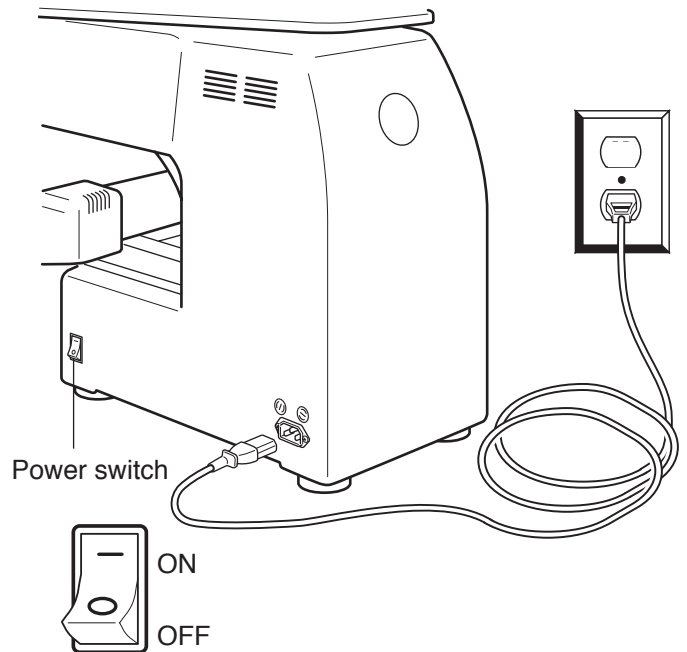
Press  to return to Drive mode.

## ● How to turn on the machine

### CAUTION

The touch screen can be operated by finger, but in some cases sensitivity of the screen will be affected by condition of the finger. In such cases, please use the fingertip or built-in stylus to hit small touch targets.


1. Connect the power cord to the inlet on the right side of the machine.
2. Connect the power plug to an electrical outlet.




3. Turn on the power switch.  
Indicates the select frame.

Please confirm the emergency stop button has been released.  
Push the power switch firmly so it will remain on.

If the following icons are displayed during startup and the startup screen does not appear, turn off the power and then turn it on again.  
If the startup screen still does not appear, contact your distributor or dealer.

 There is something wrong with the data on the built-in SD card.

 The built-in SD card is damaged or unrecognizable.



It takes about 30 seconds until startup screen is appeared.

Selected frame





# TURNING THE MACHINE ON

# 5-1b

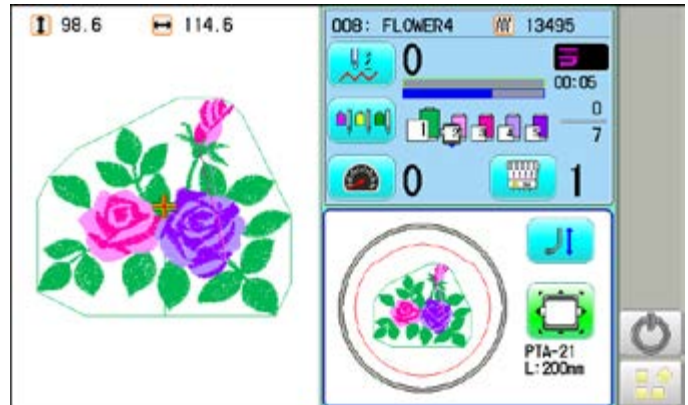
4. In case you do not need to change frame type, Press **Next**.

After the carriage and frame move slightly, the embroidery frame will return to the previous position automatically.  
Machine becomes ready for operation.



**CAUTION: To prevent accidents.**

The embroidery frame and carriage will move. Please keep hands clear for your safety.



In case you want to change frame type,

Press .



When turning off the machine, Press .

5-1c

5. Select the desired frame with .

- : Tubular round frame
- : Tubular square frame, One touch frame
- : Cap and One-point frame.
- : Border frame, Square clamp frame
- : Sock frame
- : User-defined frame
- : Special frame
- : Non registered



6. Select desired type of frame and Press

**SET**.

The display returns to the view of Step 3.

When turning off the power, follow the procedure in "How to turn off the machine 5-1c" and then remove the power plug from the outlet.



**DANGER: To reduce the risk of electric shock.**

Never leave the machine unattended when plugged in.  
Always unplug this machine from the electrical outlet immediately after use and before performing any maintenance on it.



**WARNING: To reduce the risk of burns, fire, electric shock, or injury to persons.**

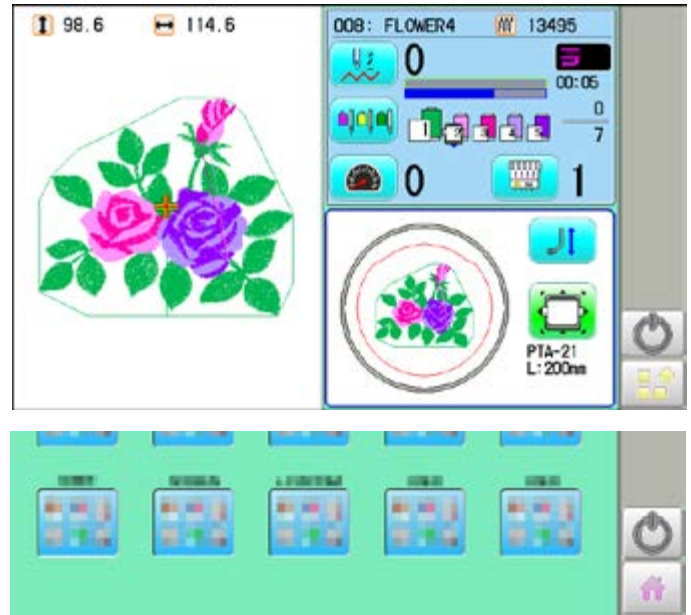
Do not unplug by pulling on cord. To unplug, grasp the plug, not the cord.

## ● How to turn off the machine

### CAUTION


When turning off the machine, be sure to press  (Power off) key on the control box to turn off the machine.


If the power can not be turned off by pressing this key due to a problem with the machine, turn off the power with the power switch.



1. Press and hold  on the drive mode or menu mode.

Shutting down...

 ON If the power can not be turned off automatically, turn off the power with the power switch.


 OFF

The power switch is automatically turned "OFF" and the machine is turned off.



## ● Calendar and clock setting


Setting the calendar and clock lets the machine advise when oiling and other maintenance is scheduled to occur.

1. When the machine is stopped, press .







2. Press  "OTHER".



3. Press  Calendar.  
Current year, month date and time is displayed.

Current day



4. Select year/month or time.  
Press right /left of   to select the setting point, and press up/down of   to select the number.


Set day



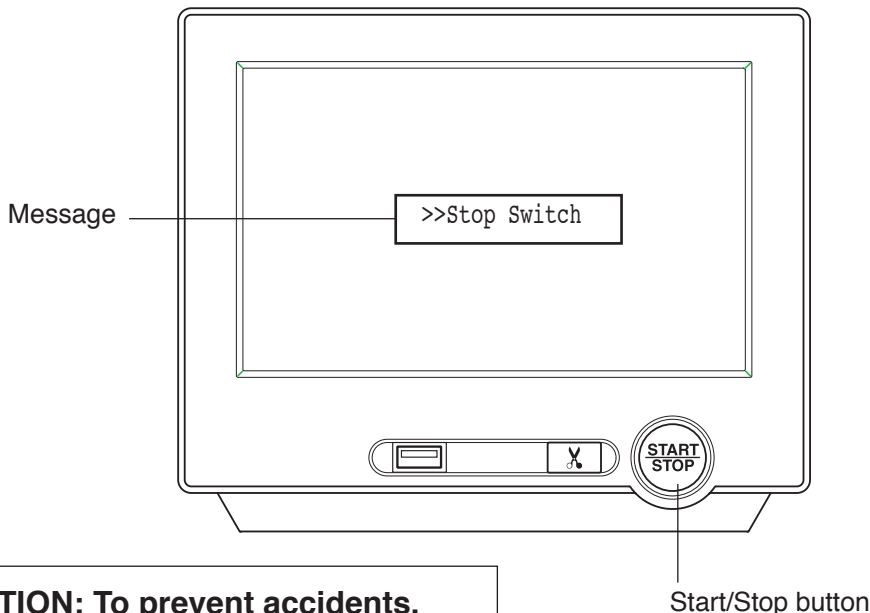
5. Press  SET.  
The date is fixed.


6. Press  OK to return to Menu mode.









Below is a list of possible messages that may appear while operating the machine, along with an brief explanation and suggested actions to take as a result.

The message with  mark will be appeared with beep sound.

Press the screen (any location is okay), then message will disappear.



 **CAUTION: To prevent accidents.**  
The embroidery frame may move. Please keep hands clear for your safety.

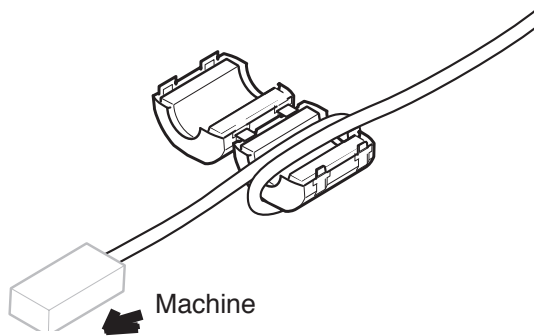
	MESSAGE	EXPLANATION	OPERATION	PAGE
	 Place to oil	Designated letter on the display is due to be lubricated.	Push [Done] and lubricate indicated location with instruction in the reference page. Push [Leter], if you can not lubricate right away. The message will be disappeared temporary, but it will come up later.	23-1
	 Cleaning of rotary hook Cleaning of thread cut knife	Clean the rotary hook and the thread cutting knife.	Clean with instruction in the reference page.	23-2
	>>Stop Switch	The machine is stopped because the stop button was pressed while embroidering the design.	Press the start/stop button to resume sewing.	
	>>End	The machine is stopped because it has finished the design.	If you wish to sew design again, please newly hooped item on machine & press start/stop button.	
	>>Change Stop	Machine stopped, because you used "Stop at color change point" function.	When you press the start/stop button, the machine will select the next color and resume embroidering automatically.	
	>>Color ?	Machine stopped, because you used "Stop at color change point" function.	Please select next needle number by needle selection button then press the start/stop button.	
	 >>Thread Break	Machine stopped, because upper or bobbin thread is broken at displayed needle number.	Please thread upper thread or check bobbin thread then press start/stop button to resume sewing.	
	>>Frame out	The "Frame out" function has been executed.	Press the start/stop button if OK.	14-D

## ●Connecting to a PC

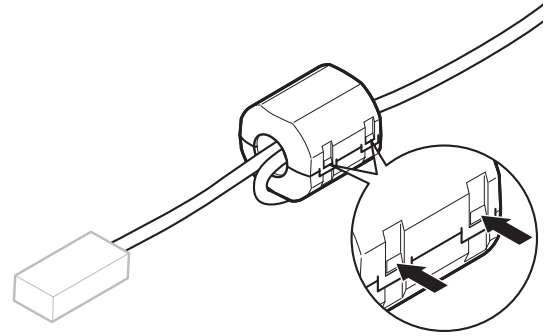
This embroidery machine will allow you to read design data from a connected PC. A USB cable or a LAN cable can be used for the connection.

### Install the clampfilter

In order to avoid unexpected trouble caused by electric noise, install attached clamp filter on the embroidery machine side on USB cable or LAN cable.



1. Please set clampfilter on new cable as picture. Clampfilter should be located close to machine. Cable should be turned around clampfilter as picture.



2. Please confirm filter is closed completely. When the filter is removed, please press latch (2 positions) on clampfilter by thin rod. Clampfilter opens and it can be removed from cable..

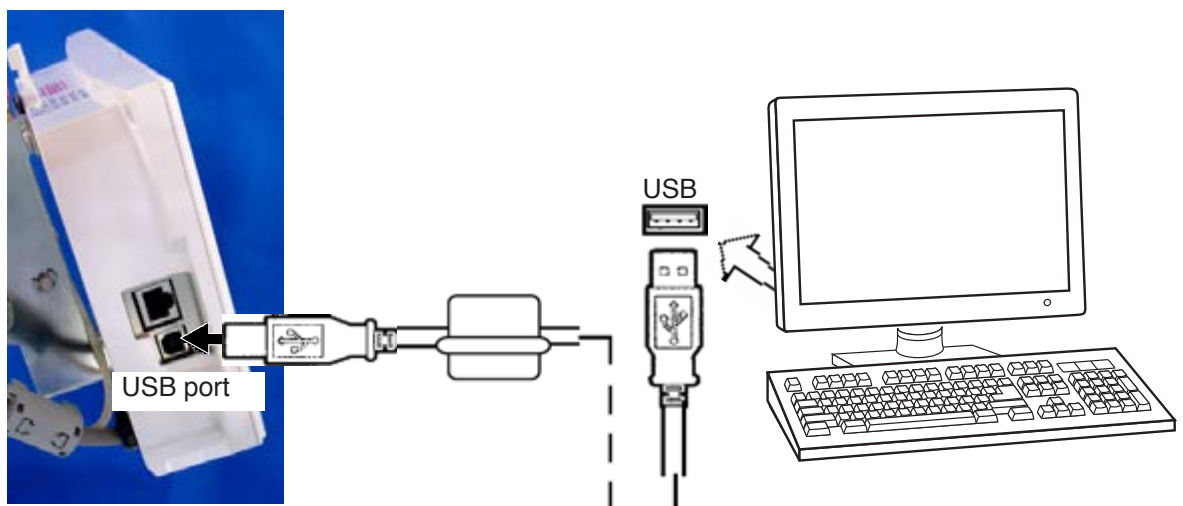
### USB connection (based on the USB 1.1, 2.0)

Connect by USB cable between USB port (Standard-B receptacle) of the machine and USB port of the PC.

When you connect the USB cable, make sure that the machine is powered and set into drive mode, and that the PC is also turned on.

After recognizing USB in your PC, start-up the "Happy Link".

Please refer to instruction book of "Happy Link" for more precise information.

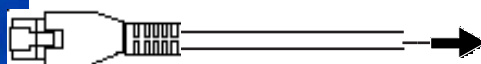
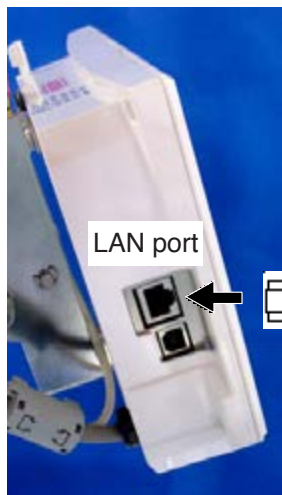


## LAN connection

Connect the LAN cable between the LAN port of the machine and the network of the PC.

Multiple and different type of machines can be connected to a PC which has Happy Link LAN software installed.

Please refer to instruction book of "Happy Link LAN" for more precise information.



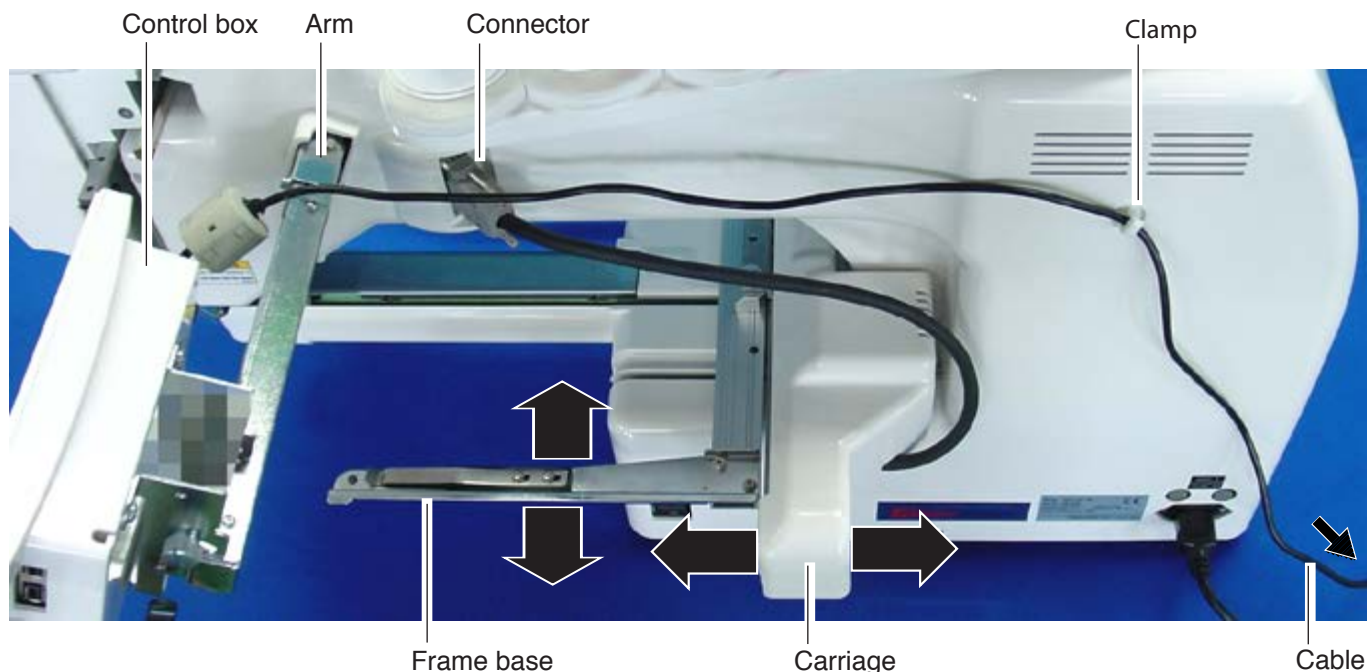
Connect to the Switching HUB or the Wireless LAN device.

Please refer to instruction book of "Happy Link LAN" for more precise information.

## Wiring of cable

The cable which is connected USB port or LAN port should be wired above the arm and the connector as picture below, and then fixed by Clamp.

■ Please make sure that the cable does not touch the carriage or the frame base during embroidery operation.



## ● Reading embroidery pattern data from the PC

Designs can be transferred to the machine along with some functions by using the "Happy Link LAN" software.

Please refer to the "Happy Link" or "Happy Link LAN" software manual for instructions.

Please refer to the "Happy Link" or "Happy Link LAN" software manual for instructions.

The maximum number of registrable pattern will be 3000.

Please use following software version which supports the "max. registrable pattern" function.

" Happy Link Ver. Ver. 4.03 or later"

" Happy Link LAN Ver. A2.03 or later"

## ● Read embroidery pattern data

Read the pattern to be embroidered from the memory media.

These types of memory media can be used.

This machine is able to read FAT or FAT32 format memory media, which are generally used.

- USB flash drive

- If you initialize the memory media with your PC, please proceed with FAT or FAT32 format.

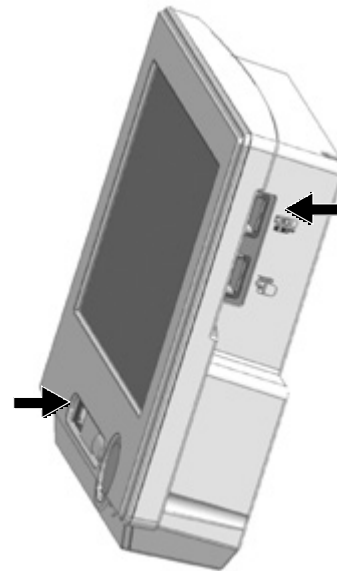


### Handling note of memory media.



Do not bend, drop, disassemble, charge or heat the memory media.  
Keep away from humidity or direct sunlight.

## To insert a USB flash drive

1. Insert the USB flash drive all the way into the USB flash drive port of the machine (front or right side of control box).
2. Read embroidery design data according to following “Reading pattern data” in the next section.





## To remove a USB flash drive

Press  or  to return to the menu mode or drive mode, and then slowly remove the USB flash drive by hand.



### Removing note of USB flash drive

When removing the USB flash drive, be sure to press  or  to return to the menu mode or drive mode.

If you remove the USB flash drive while viewing, reading, or writing, the data in the USB flash drive will be damaged.

## Reading pattern data

This reads pattern data and writes into memory.



When the HAPPY format pattern data with \*various function settings are read in memory, various functions such as needle bar selection, pattern data adjustments and etc. will be set automatically. (It is necessary to set "etc.func read". P. 10-3)

In addition to memory media, this machine can read pattern data saved in the PC connected with "Happy Link LAN".

Design folder settings on the "Happy Link LAN" is required before reading pattern data.

Please refer to "Happy Link LAN" System INSTRUCTION MANUAL regarding the settings method.


The pattern data can be read through the designated folder and sub-folders by accessing from the machine.

- If the Happy or Tajima pattern data has Barudan or ZSK \*data. (Tajima file :  DSB [Barudan] or  DSZ [ZSK])

The machine can read HAPPY and Tajima pattern data normally when "Auto" is selected at SETTING RANGE of SETTING ITEM 7 data format of Pattern read settings on page 10-3.

If the machine dose not read pattern data cannot at "Auto", please try with other data format

1. Insert the USB flash drive into the machine as described in "Inserting USB flash drive".

2. When the machine is stopped, press .





3. Select "READ".








Un-recognized device will be shown with gray color.

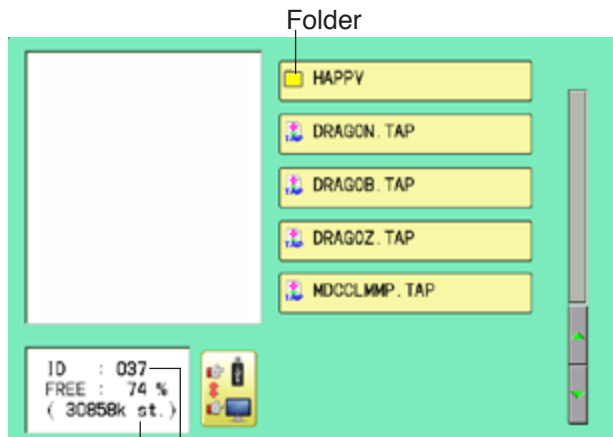
--- Serch pattern ---

4. Select  (USB flash drive) or  (Pattern data in the PC).

Indicates pattern data.

-  TAP : HAPPY
-  DST : Tajima
-  DSB : Tajima (Barudan)
-  DSZ : Tajima (ZSK)

 Folder : Contents of folder will be displayed when you select this icon.



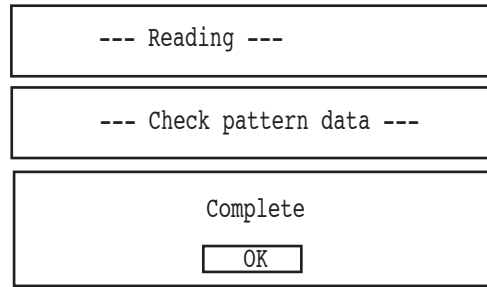
Free memory  
The designs new ID number in the machines memory.



## 5. Select pattern data.

1 % of free memory is equivalent to about 1,000,000 stitches.  
If there are more stitches than remaining space, you may need to delete some designs to make room for the new patterns.


Once design is read.



## 13. Press .

Enable to read other pattern data.

If you wish to read another design, continue to read other pattern data.

If you press , the display will return to step 3.

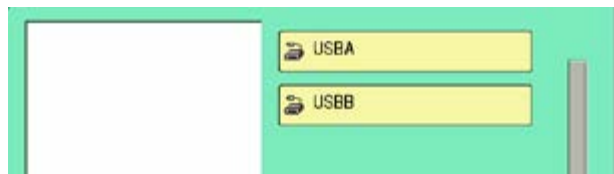
Switch the source you would like to extract pattern data from.





Press  to return to Menu mode.

Press  to return to Drive mode.

The name of USB flash drives (volume label) is displayed when multiple USB flash drives are inserted.  
Select the USB flash drive to use.




When the screen displays pattern data in the folder,  is displayed.

When  is pressed, the screen moves off from the current folder.



## Read the all designs

The icon  allows you to read the all designs at once which are located in the currently opened folder or directory.



## Search


Search pattern data or folders stored in the selected USB memory (or PC) by name.


1. Press  .


In this keyboard for searching, all design names are checked beforehand and only candidate alphabets will be highlighted along respective digits.

2. Enter the whole or a part of the name.


To search a folder, press  and then enter.

 Switches between pattern search and folder search.

 All the letters and/or numbers are deleted.

 The letter is deleted before the cursor position.

 Cancelled.

 The search will start.

Search for pattern Cursor



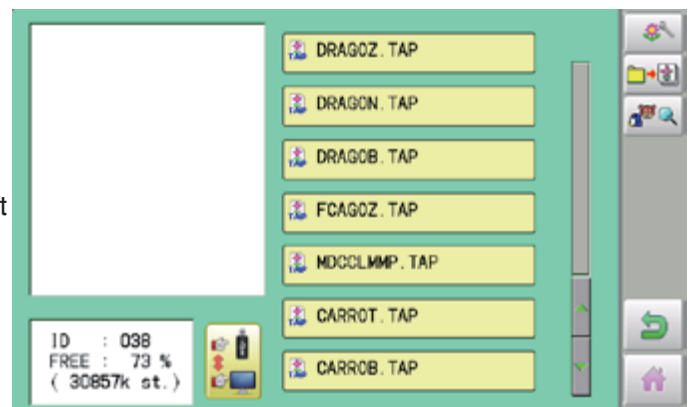
Search folder



3. Press  .


Displayed a selection screen for the searched pattern or folder is displayed.

When multiple searches are performed, the first selection screen searched from the top of the selection screen is displayed.



## ● Selection of folders

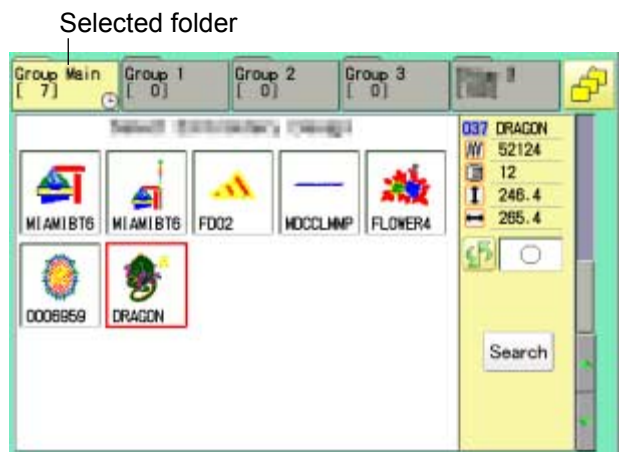
The pattern data memory is consist of 20 individual folders.  
Select desired folder to choose or input pattern data.

1. When the machine is stopped, press  .



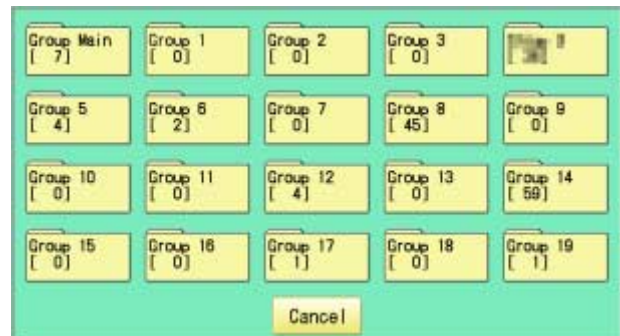
2. Select "PATTERN".

The pattern data of the selected folder will appear on the display.



3. Go on to step 4, if you want to select pattern from displayed folder.

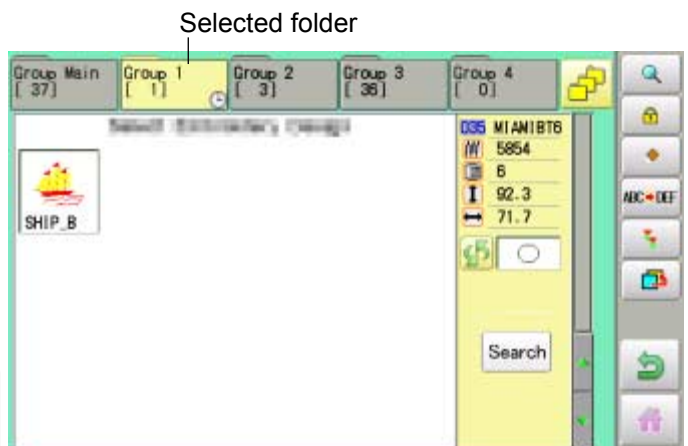
Press  to select from whole folders.



4. Select desired folder.

The selected folder has been switched.

You cannot switch to the folder without pattern data.




Press  to return to Menu mode.

Press  to return to Drive mode.

## ● How to select patterns from memory





To select an embroidery design previously stored into the machine memory.

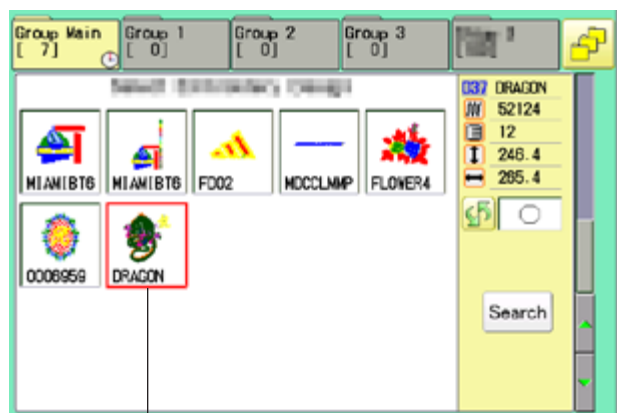
1. When the machine is stopped, press .



2. Select "PATTERN".

The display indicates the current pattern. The right side of display shows the number, name and details for the current pattern.

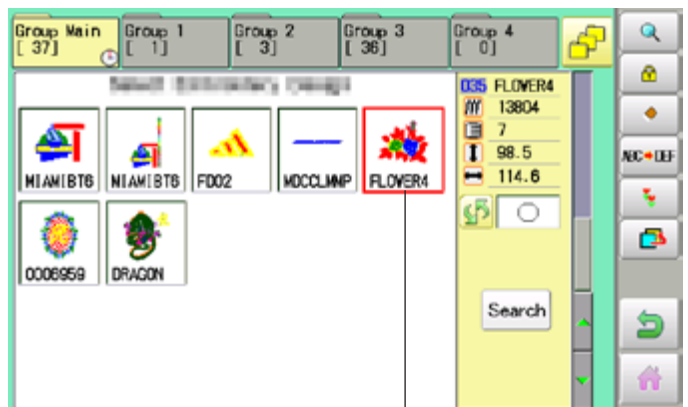
-  Number of stitches
-  Number of Color change number
-  Height
-  Width



Selected pattern data

3. Select pattern data.

This pattern will be selected.




Selected pattern data


Press  to return to Menu mode.

Press  to return to Drive mode.

## ●Erasing patterns from memory

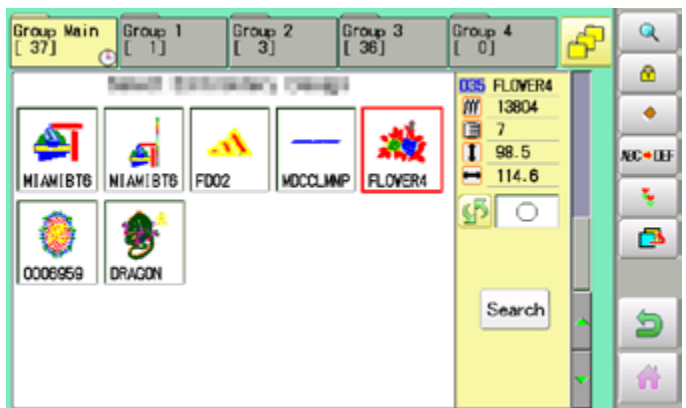
This is to erase an unnecessary design data from the machine memory.

 Pattern data cannot be erased if the lock is set.

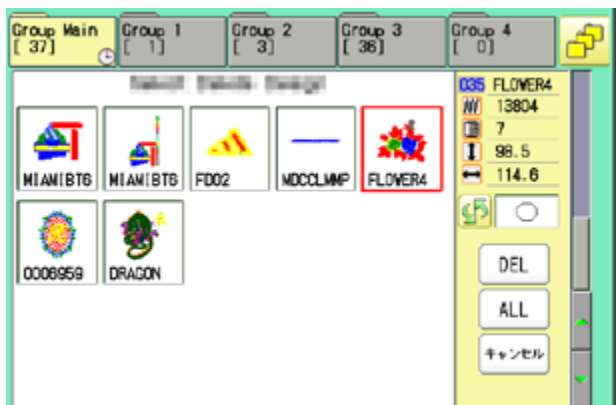
1. When the machine is stopped, press  .



2. Select "PATTERN".




3. Press  from right submenu.

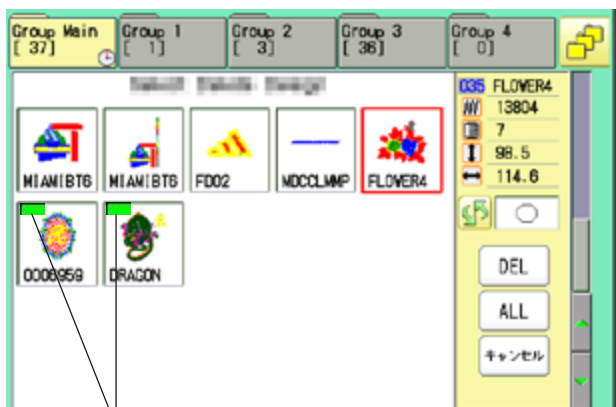


4. Select desired pattern.

Mark will appear left of the pattern.  
 Make will be cleared by press it again.  
 Multiple pattern data can be selected.

 : Select all the pattern data


 : Cancel pattern data erasing



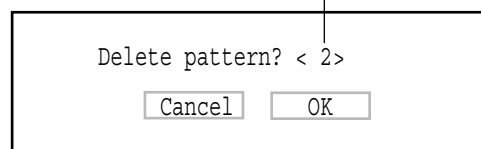
Mark

# PREPARATION OF PATTERN DATA

# 5-C

5. Press .

Showing number of delete design(s)



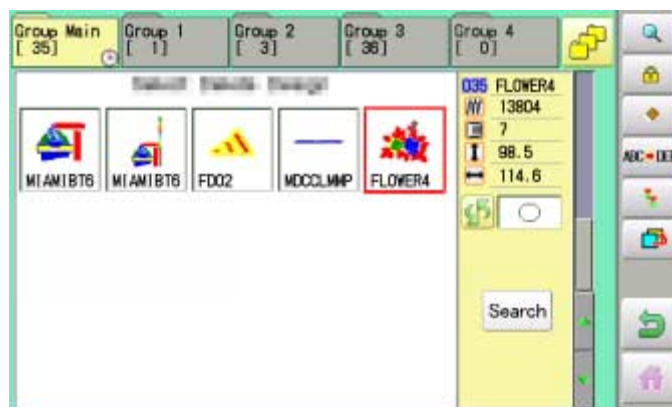
6. Push "OK" to delete.

The item will be deleted.

To delete other patterns, repeat steps 3 to 6.

Press "Cancel" to cancel the delete.

The display will return to step 2.




Press  to return to Menu mode.

Press  to return to Drive mode.

## Erasing all patterns from memory

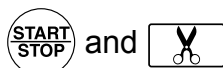
This is to erase all design data from the machine memory.

 Pattern data can be erased if the lock is set.

1. When the machine is stopped, press



2. Select "PATTERN" while pressing the



3. Press .

The item will be deleted.


# NEEDLE BAR SELECTION

# 5-E

For each color change in a given pattern, the needle number loaded with the correct color thread is assigned by the operator. When this is set, the machine automatically changes to the programmed needle when the design reaches that point in the course of sewing the design.

 You can not setting "NEEDLE" for selected "LOCK" design.

Please release "LOCK" from design.  11-1

1. When the machine is stopped, press .



2. Select "NEEDLE".

The screen of color number 1 selection is displayed.

The current color number is showed in the pattern data display portion.



Color change number      Current color change number  
Needle number      Number of color change number

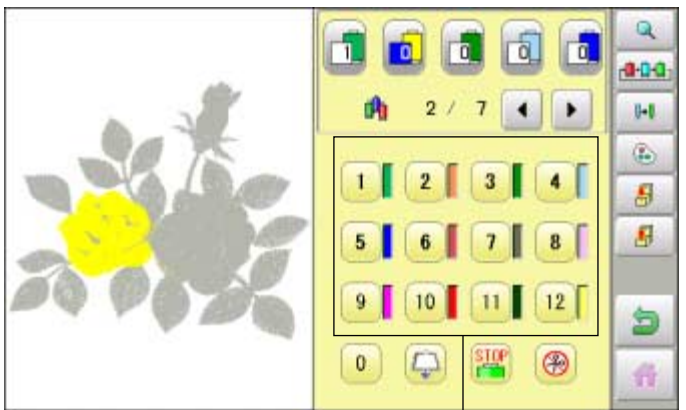


3. Select the needle number.

After setting the needle number on color number, the following color number selection is displayed.


You can also select color number directly.

You can switch color change numbers with   if the color change number has more than 5.




4. Select the needle number on all the color change numbers.

Press  to return to Menu mode.

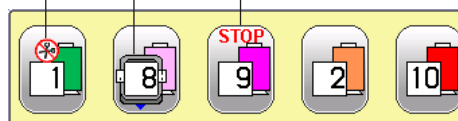
Press  to return to Drive mode.

Needle number

Press  to on the sub menu to check the setting.




No thread cut mark      Frame out mark      Color change stop mark



### Color change stop function

When a color change stop is set to a color change number, the machine will stop after it finishes sewing the marked needle number, then following message will be shown:

When you wish to start again, Press  (Start/Stop button).

1. Select a color change number and press .


The mark is displayed on the color change number.


2. Set it to the same on other color change number if necessary.

### Selection of color change number

Set Color change number to execute frameout set at "PATTERN SETTINGS".


A frame out command can be added to a design. By setting frameout to a \*Color change number in a design, you can move the frame to a desired position automatically and stop it after the machine finishes sewing of that color change number.

When you resume operation, the frame has an automatic return to previous position and you can continue sewing.  14-D

1. Select a color change number and press .

The mark is displayed on the color change number.

2. Set it to the same on other color change number if necessary.

■ When you turn frameout "On" without setting the movement distance of frameout at "PATTERN SETTINGS", the frame will move automatically to the position which was set already with "20 Frameout position" at "MACHINE SETTINGS".  5-1b.

### No thread cut after color change

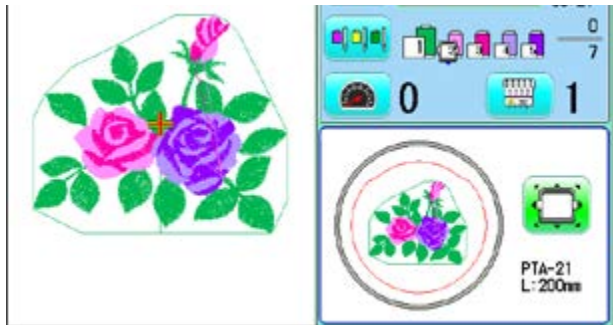
When "no thread cut after color change" is set on a color change number, thread cut is not done after color change at the specified color change number and the machine switches to the next color change number.

"No thread cut after color change" function can be set by combining color change stop or frame out function.

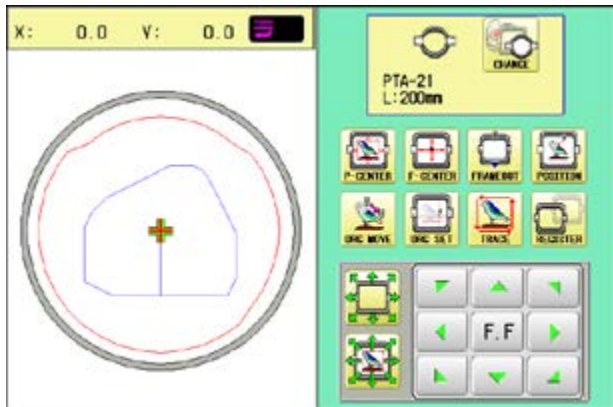


## ● Installing and removing the frame base

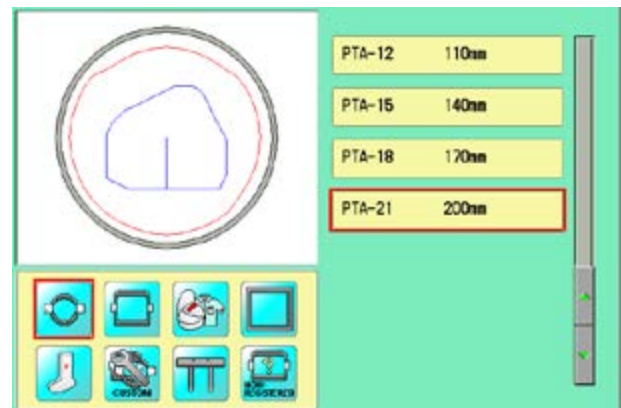
Please attach the frame base to the carriage when you wish to use a tubular embroidering hoop. Please remove it in the reverse order of installation.



1. When the machine is stopped, press





2. Press



3. Select   or .

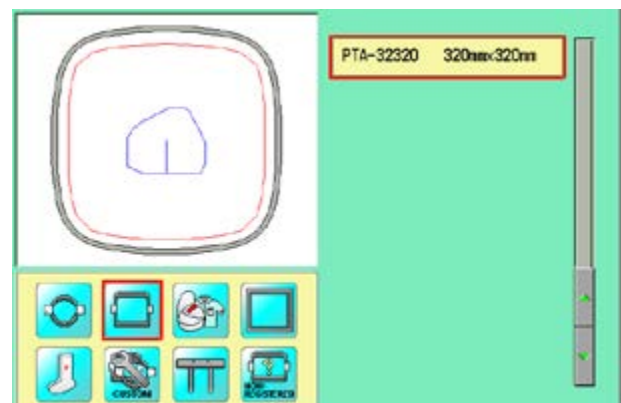
 : Tubular round frame

 : Tubular square frame

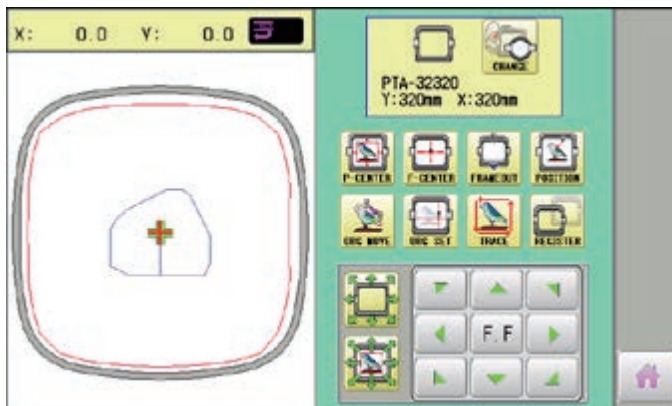
 : User-defined frame



4. Select desired type of frame.



5. Press  button.

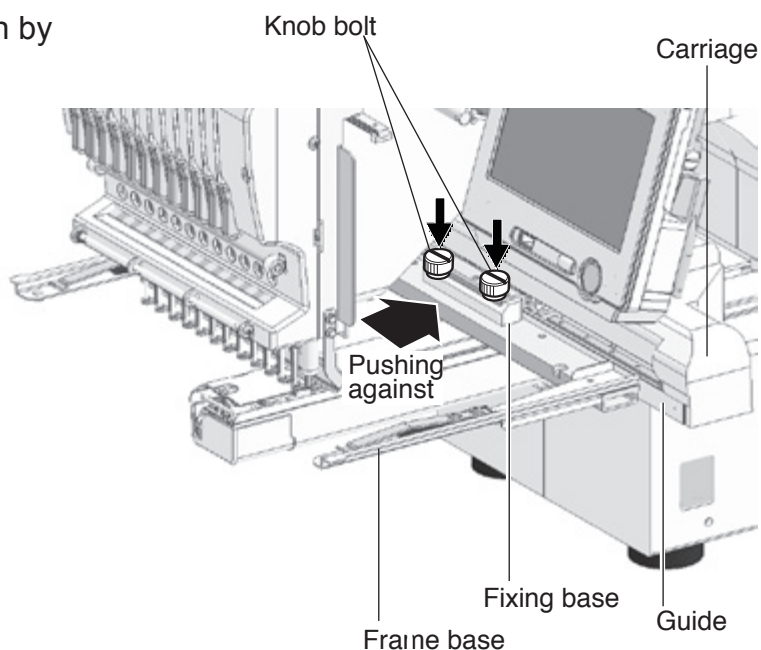



6. Move the carriage to the position shown by



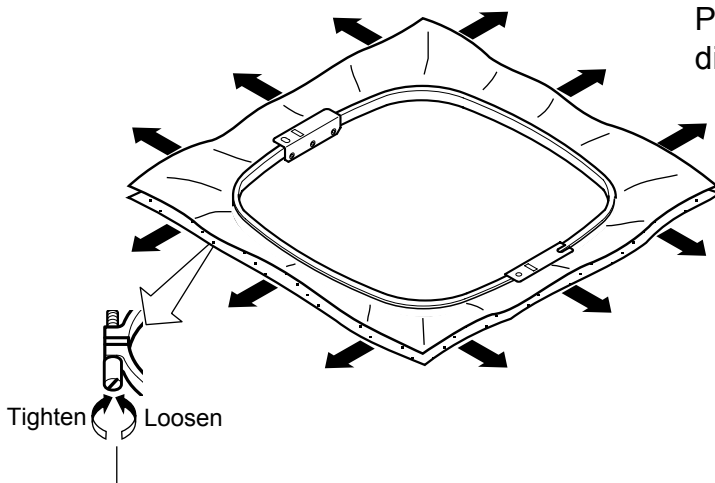
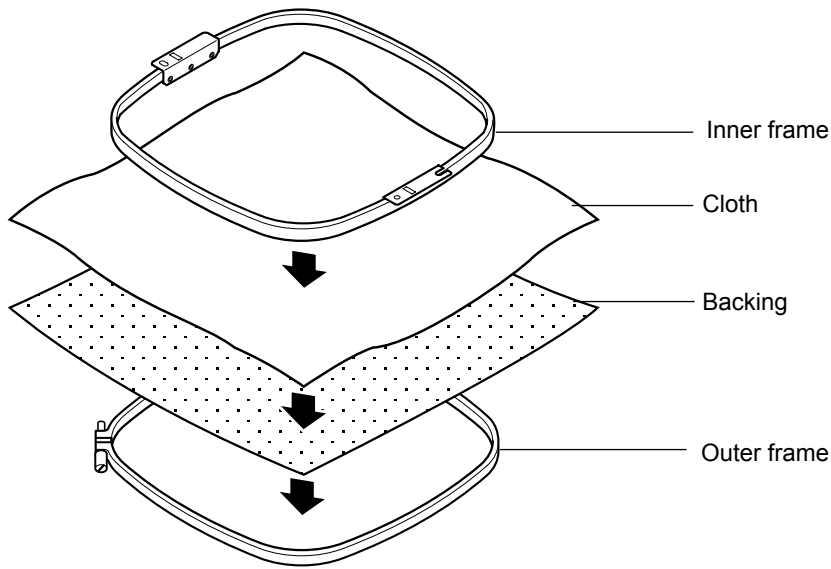
7. Place the frame base on the carriage guide and tighten the knob bolt on the tubular arm holder completely.

Move the frame base right or left when it is hard to tighten the knob bolts.



Press  to return to Menu mode.

## ●How to hoop

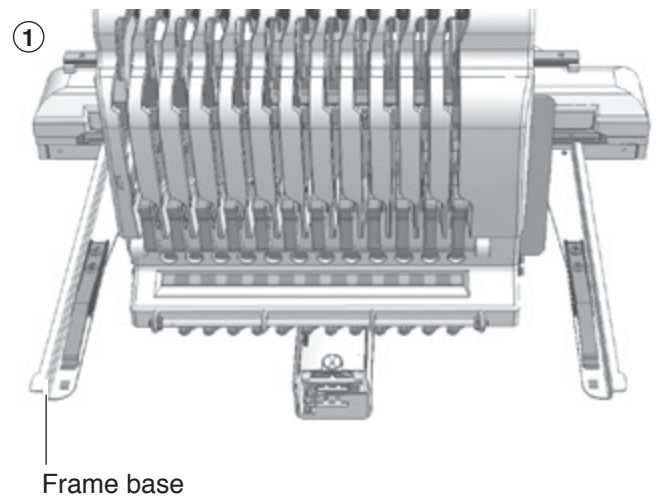


Please stretch the embroidery cloth in the directions of the arrow to smooth the cloth.

Do not stretch the elastic cloth too much.

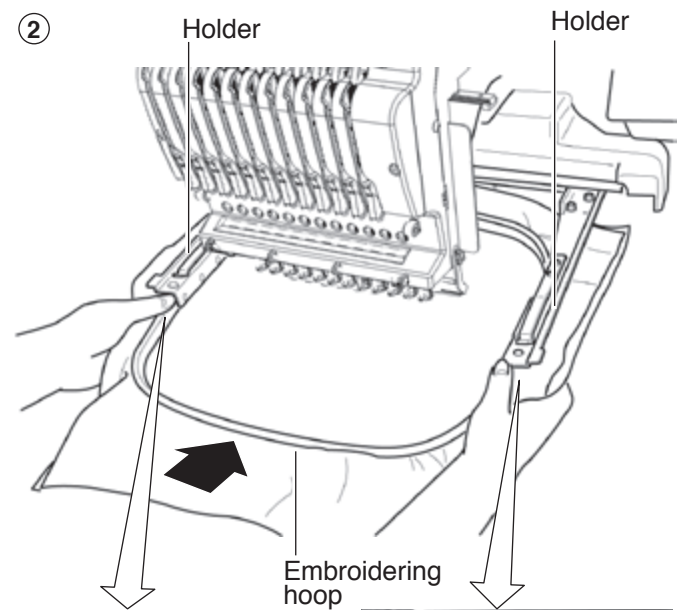
## ● Putting the hoop on the machine

1. Move the frame base to the approximate center position before inserting the tubular embroidering frame.

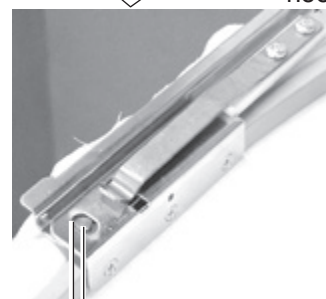


2. Insert the embroidery frame.

Make sure that the holder pins are inserted into the positioning holes of the frame base on each side.



Embroidering hoop



## Use TAJIMA made tubular frame

You can use TAJIMA made tubular frame which has the same installation width (space between left and right positioning pin) as HAPPY's frame by changing the position of both left and right hold springs and left and right hold spring bases.

Follow the procedure below after removing tubular frame.

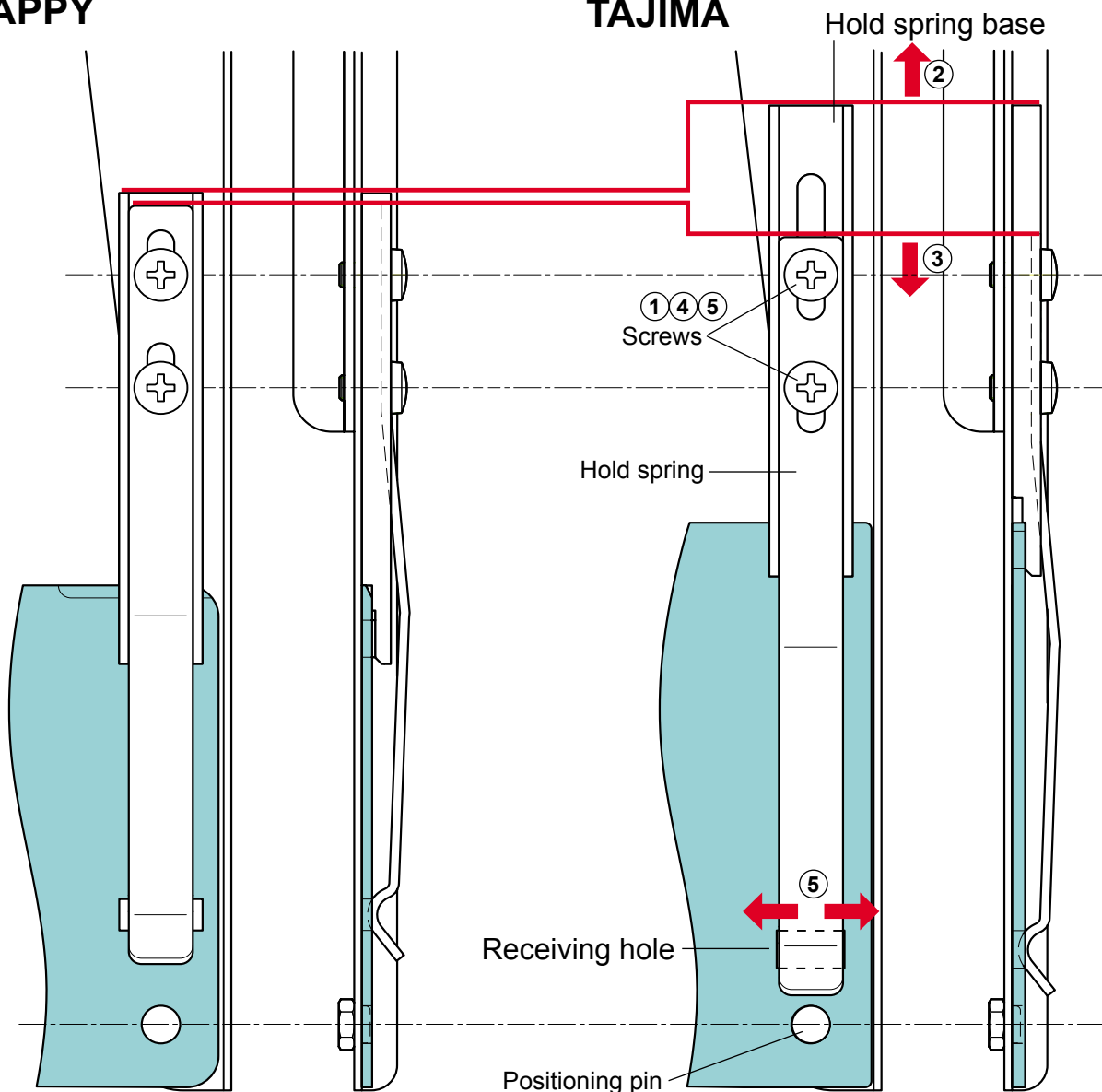
1. Loosen screws (2 each at both left and right).
2. Move both left and right hold spring bases deep into screws.
3. Move both left and right hold springs forward until the spring touches screws and stops moving.
4. Tighten screws (2 each at both left and right).
5. Install tubular frame and check if the tip of both left and right hold springs enters receiving hole on tubular frame.

If the tip dose not enter receiving hole, loosen screw, rotate hold springs left or right so that the tip can enter the hole, and tighten screw.


Please reverse the procedure above when returning to the position of something before change has been made.

### HAPPY

### TAJIMA



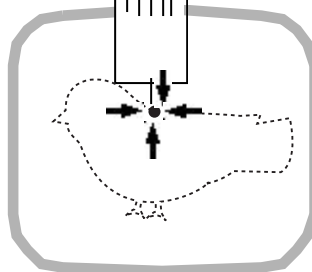
## ● Starting to embroider

1. Press  and move the frame to the

original point with the





■ : Original point (Start point)




2. Press



After the moving head moves to the left end, the laser pointer will turn on.

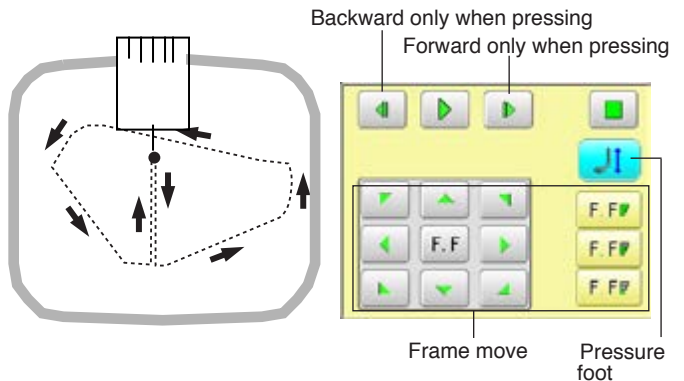
Press , and the embroidering frame moves for the design trace.  10-4


You can confirm outline trace and the position of the design.

Press , and trace is stopped.

Go on to step 4 if you want to start embroidering without tracing.

**CAUTION: To prevent accidents.**  
The moving head will move.  
Please keep hands clear for your safety.

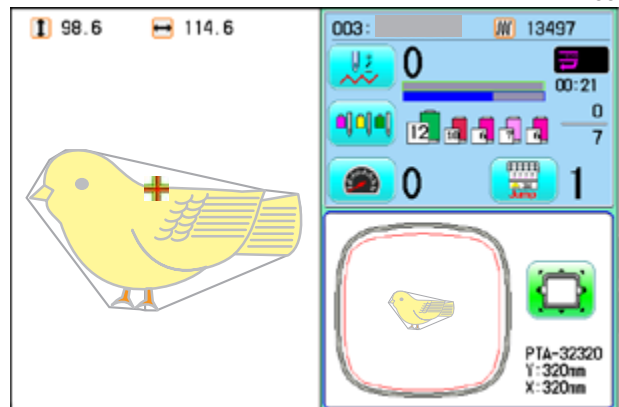


3. Press  after the trace is completed.

The embroidering frame has moved to the first stitch point of the pattern.

4. Press .

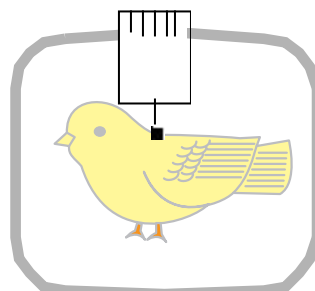
The embroidery will start.



5. After embroidering your design is complete, show ">>End" and the machine will stop.

The embroidery frame returns to the original point automatically if the "Auto origin" function has been activated.

>>End




## ● Installing and removing the cap drive frame




You need to install the cap drive frame into the carriage when you embroider a cap.  
Please remove by reverse order of these step.




1. Press  and Press  .  
The embroidery frame will move to the center .


 **CAUTION: To prevent accidents.**  
The frame moves quickly.  
Keep hands away from the frame.



2. Press  and press and hold  .  
 5-1c

Shutting down...

 ON    If the power can not be turned off automatically, turn off the power with the power switch.

 OFF

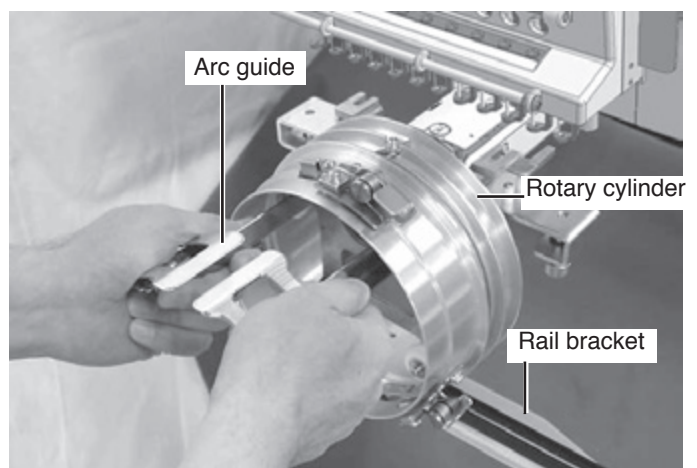
The power switch is automatically turned "OFF" and the machine is turned off.



3. Hold the arc guide by hand and the rail bracket has to be faced downward, then install into the bed as showing picture.

When you hold the cap drive frame assembly, be sure to hold the arc guide of the cap drive frame assembly.

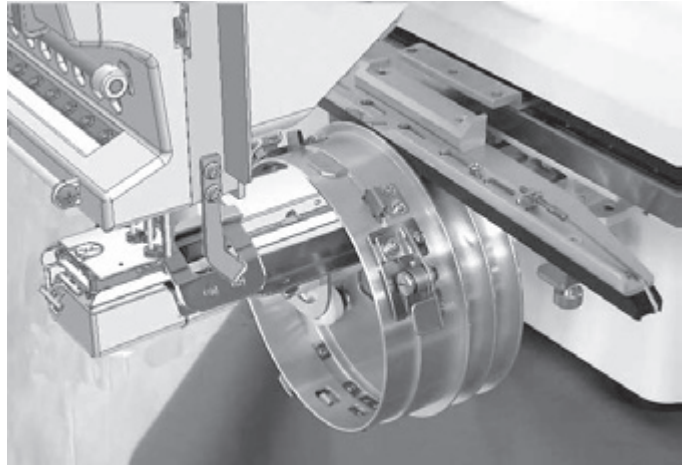
If you hold the rail bracket, your fingers will be pout between the rail bracket and the rail bracket rotary cylinder and rail bracket can get out of place.



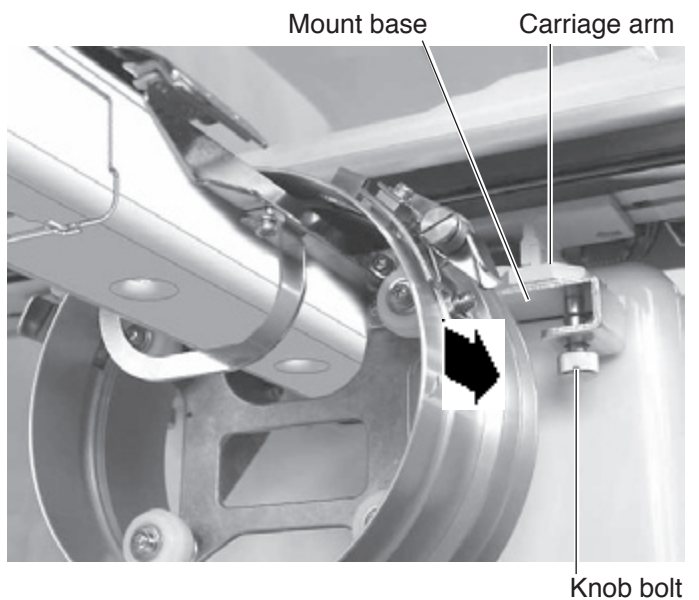
## CAP FRAME (OPTION)

7-3

4. Move the cap drive frame backwards away from you and rotate the rotary cylinder until the rail bracket is upward as shown at right.

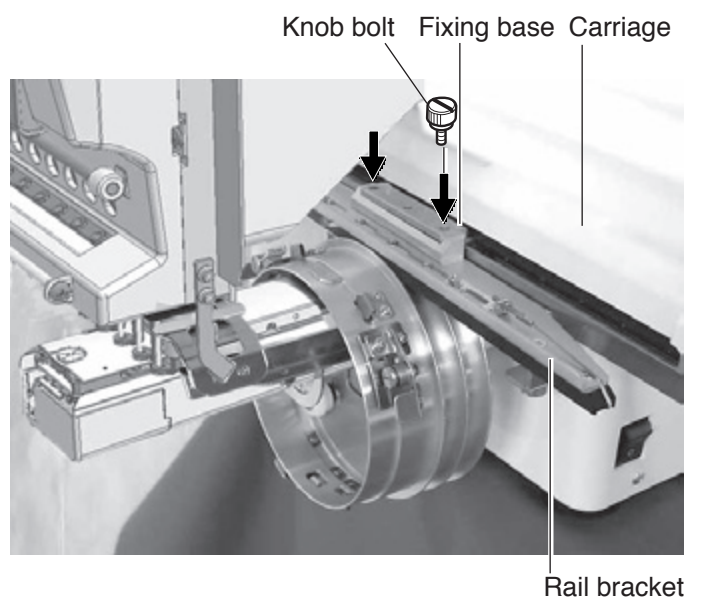


5. Move the cap drive frame in the direction of the arrow, adjust right-and-left mount base to carriage arm and fix them by knob bolts.



6. Fix the rail bracket to fixing base by knob bolts.

You can move the fixing base right or left when it is hard to tighten the set screw.





7. Turn on the power switch.


Selected frame is indicated.



Selected frame



8. In case required Cap frame is already selected, please jump to operation no.10.


In case selected frame type is not same as your requirement, Press .



9. Select the desired frame.

10. Press .

The embroidery frame will move to the center automatically.

 **CAUTION: To prevent accidents.**  
The frame moves quickly.  
Keep hands away from the frame.



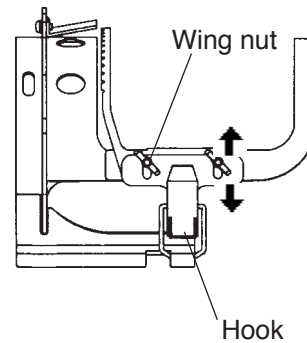
## ● Normal cap frame

### Adjustment

When you hoop a cap on the cap frame, please adjust in the following manner:

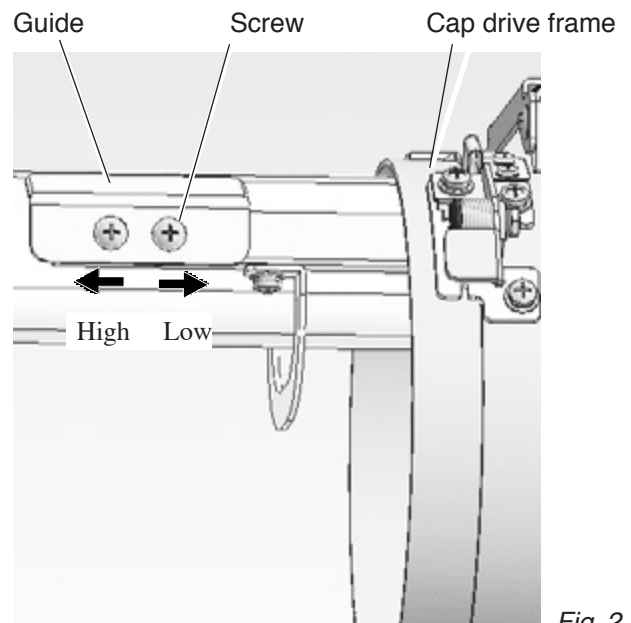
1. Adjust up and down position of the hook according to the thickness of the cap to adjust clamp tension. At this moment, the hook should open and close without feeling too tight.  
(For adjustment, proceed to procedure 5 below).  
Use the wing nuts for adjustment. (Fig. 1)

If the hook is extremely tight, it will damage the cap frame permanently.



*Fig. 1*

2. Adjust the guide position to suit the height of the cap.  
Remove screws at left and right to adjust. (Fig. 2)



*Fig. 2*

# CAP FRAME (OPTION)

7-6

## Hooping caps

1. Place cap stretcher securely on a sturdy work bench.
2. As shown in Fig. 5, hold cap frame with both hands and place on cap stretcher. By pushing locking levers at 2 places with fingers, place cap frame so that center guide of cap stretcher fits in concave area of cap frame.

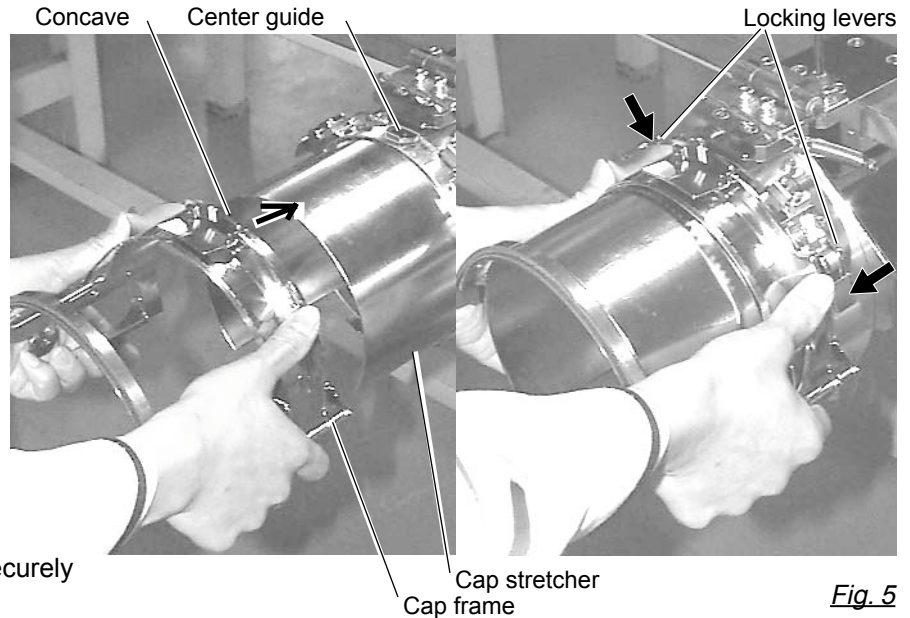


Fig. 5

Confirm that the cap frame is securely placed on cap stretcher.

3. As shown in Fig. 6, open clamp and keep open to the right.
4. Take the front half of the sweatband out of the cap and cover the cap stretcher with the sweatband. Cover the cap stretcher with the sweatband so that the edge of the sweatband contacts the flange of the cap frame.

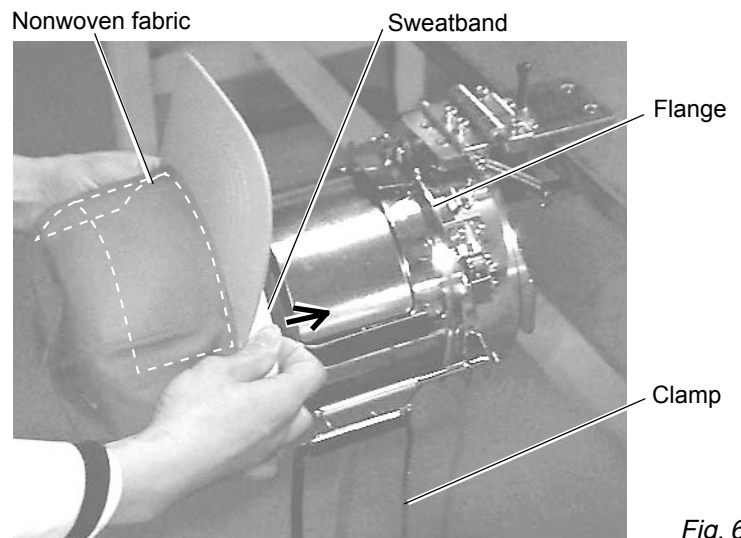


Fig. 6

Please place one or two sheets of nonwoven fabric (backing) of standard thickness under unstructured caps.

5. As shown in Fig. 7, pull back part of cap and hook it temporarily on the hook and smooth out wrinkles on cap. At this time, align the center of the cap to the center mark on the cap frame so that notched portion of the clamp fits into the seam of the visor of the cap.
6. Latch the hook, taking care not to cause wrinkles in the cap.

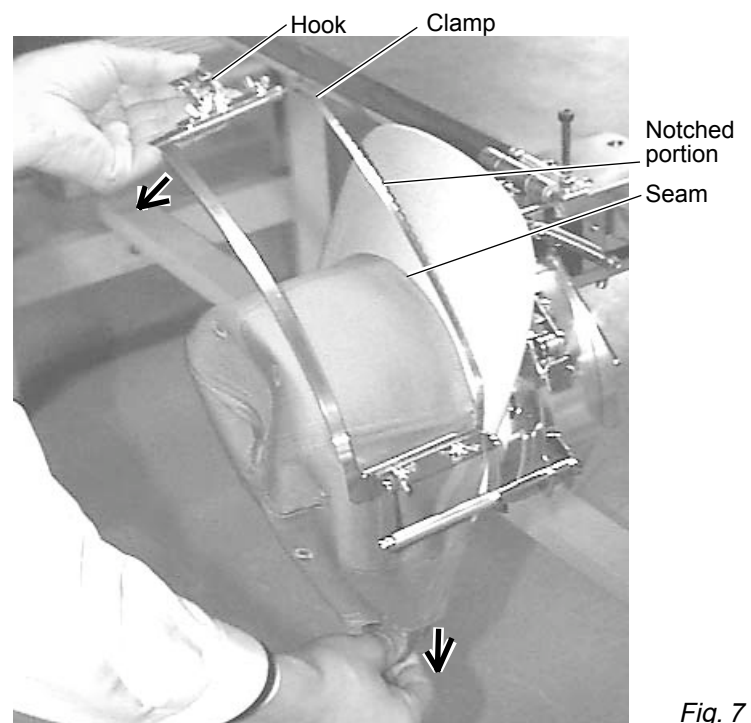
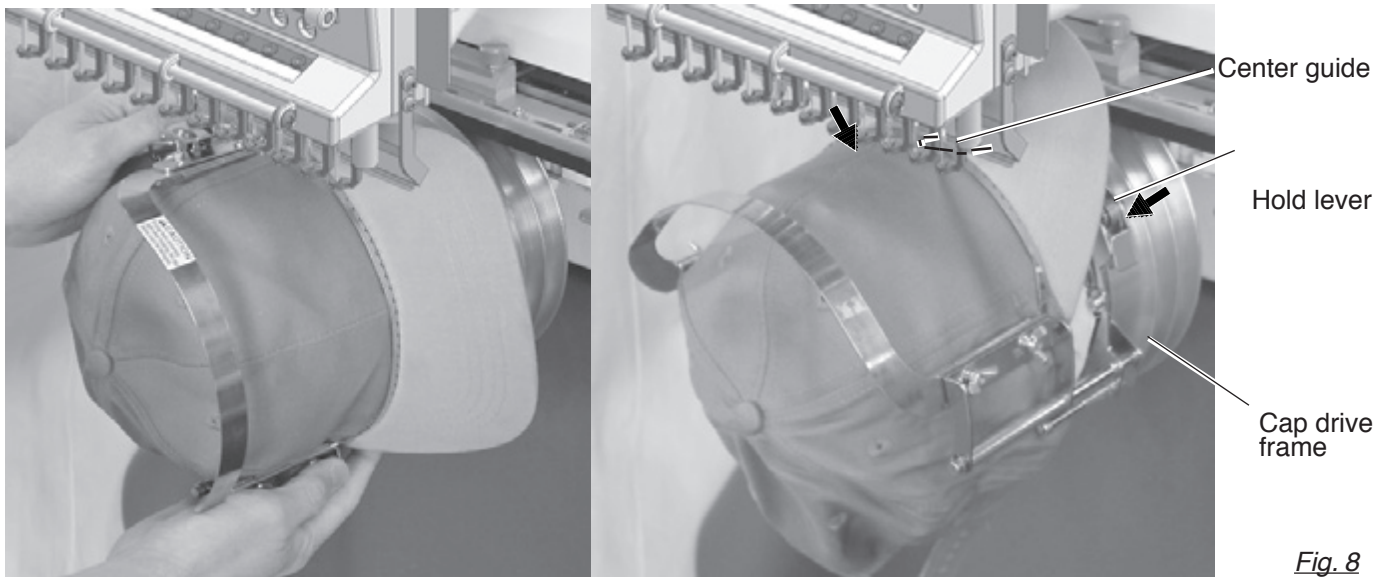


Fig. 7

If you can't get rid of wrinkles on the cap, adjust the cap frame again according to "Adjustment" of the previous page.



*Fig. 8*

7. Remove the cap frame from the cap stretch-er.
8. As shown in Fig. 8, place the cap frame on cap the drive frame.  
You will have to rotate the brim of the hat to the side in order to get past the needle case. Then, push the holder lever in the 2 places shown, and place the cap frame on so that the center guide of the drive frame assembly fits into the cap frame notch.

Confirm that the frame is firmly seated on the cap drive frame assembly without any gaps.

If there is a gap between the cap frame or the cap drive holding lever doesn't go into the hole of the cap frame, loosen the set screw on the hold lever for adjustment.

## ● Wide cap frame

### Adjustment

When you fix cap to cap hold frame, please adjust in the following manner.

Make sure to do the adjustment of the cap hold frame. If it is not adjusted properly, it may cause the deformity, damage of the cap, damage of the cap hold frame and break of the cap grip.

After adjusting the cap hold frame, make sure the cap to be set properly.

1. Adjust the length of the cap grip to suit the thickness of the fabric. At this moment, hook should open and close without feeling heavy.  
(For the adjustment follow the next page "Hooping caps" item 1 to 5.)  
The adjustment to be done by two adjusting screws. (Fig. 1)

If the cap grip is loose, even after hooked the cap is not fixed tightly and the cap is moving. (Fig. 2)

If the cap grip is too tight, you feel heavy when it is hooked and the grip bites into the cap too much. (Fig. 3)

If you feel hook extremely heavy in opening and closing, there is a case that cap hold frame will lose its shape or damaged.

2. Adjust the guide position to suit the height of the cap.  
Remove screws at left and right to adjust. (Fig. 4)

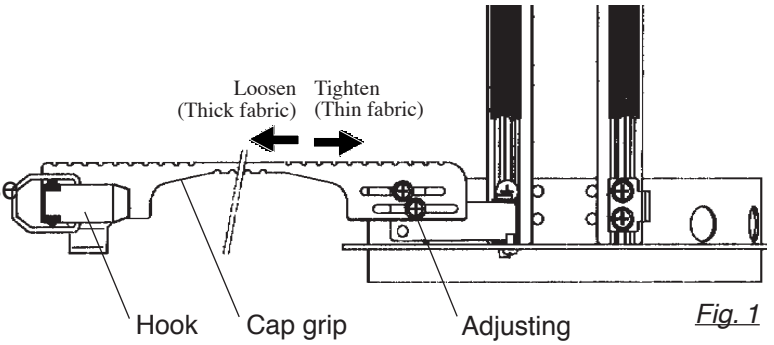
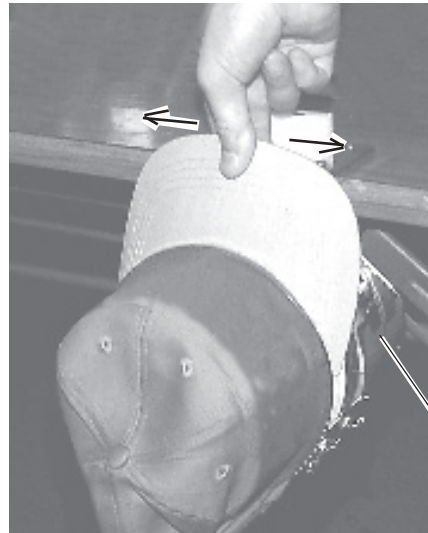


Fig. 1



Cap stretcher

Fig. 2



Fig. 3

Guide Screw Cap drive frame

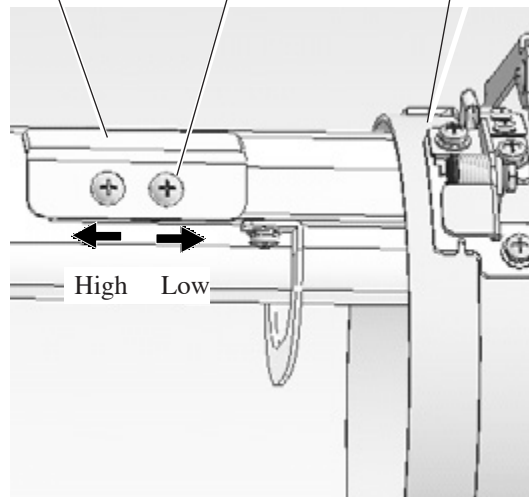


Fig. 4

# CAP FRAME (OPTION)

7-9

## Hooping caps

1. Place cap stretcher securely on sturdy work bench.
2. As shown in Fig. 1, hold cap hold frame with both hands and place on cap stretcher. By pushing hold lever at 3 places in arrow marks with fingers, place cap hold frame so that center guide of cap stretcher gets in concave of upper cap hold frame.

Confirm that cap holder frame is securely placed on cap stretcher without gap.

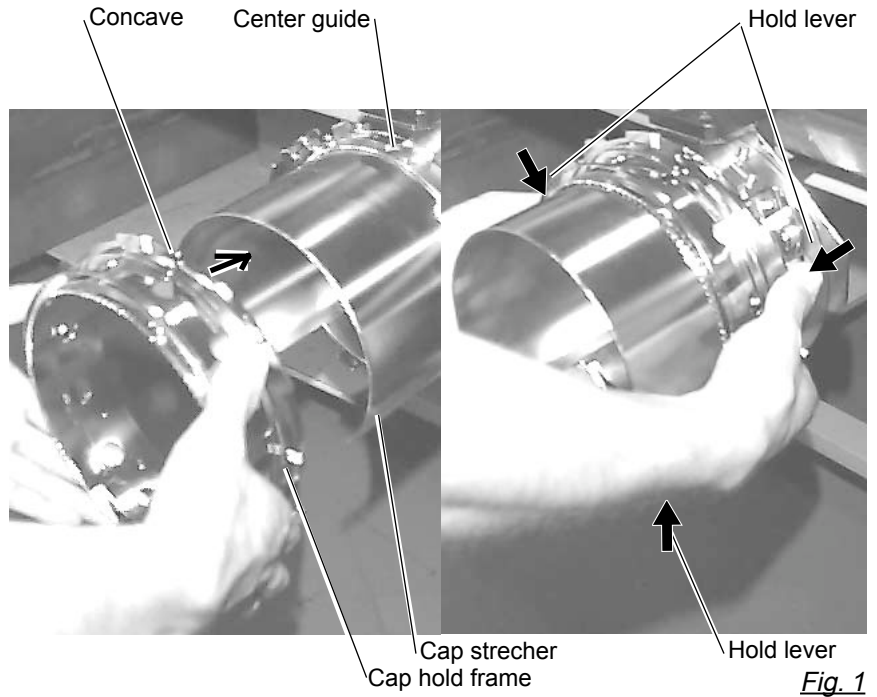


Fig. 1

3. As shown in Fig. 2, remove cap grip and keep open to the left.
4. Take the front half of the sweatband out of the cap and cover the cap stretcher with the sweatband. Cover the cap stretcher with the sweatband so that the edge of the sweatband contacts the flange of the cap frame.

Please place one or two sheets of nonwoven fabric (backing) of standard thickness under unstructured caps. The length of nonwoven fabric should be the same as one of round of cap.

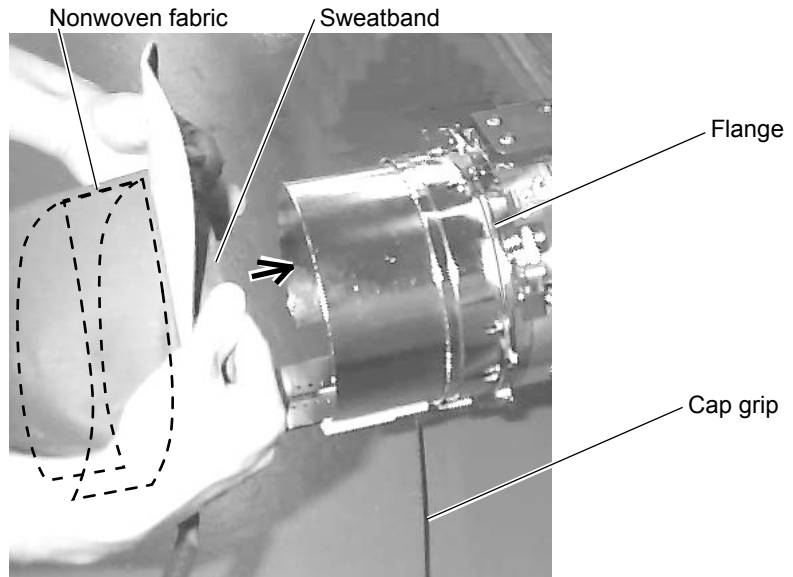


Fig. 2

5. Place hook of the cap grips. At this time, align the center of the cap to the center mark on the cap frame so that notched portion of the clamp fits into the seam of the visor. Close hook.

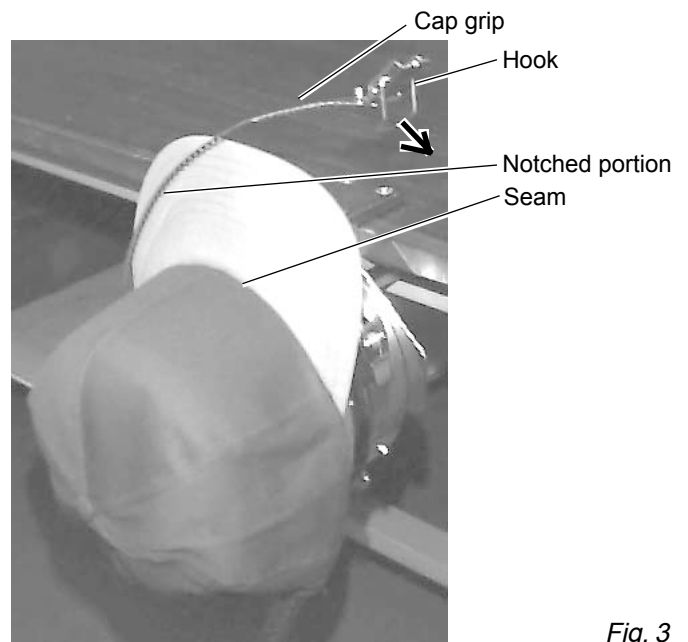


Fig. 3

## CAP FRAME (OPTION)

7-A

6. As shown in Fig. 4, tip the cap stretcher forward. Clip the back of the cap in two places by stretching the crease out as shown by the arrows.

Make the clip lever face the inside.

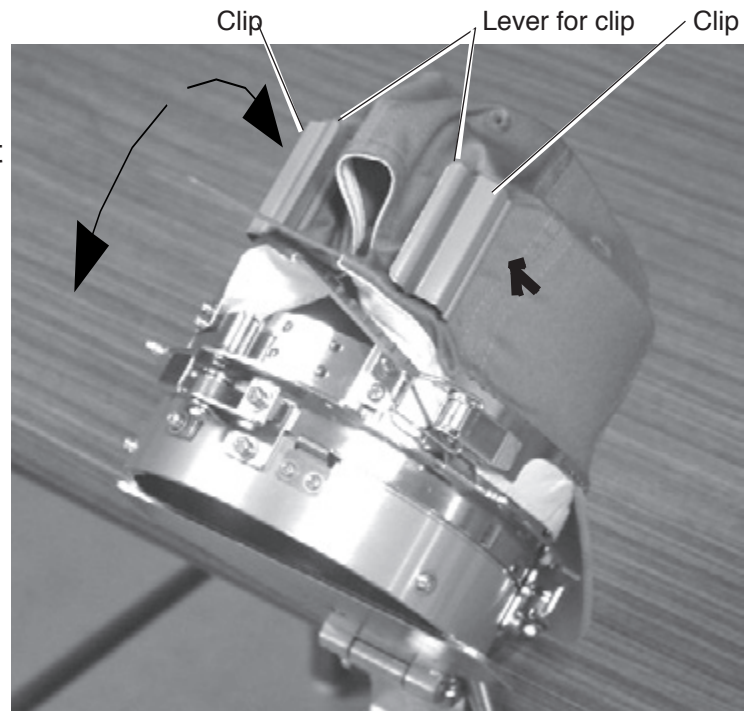


Fig. 1

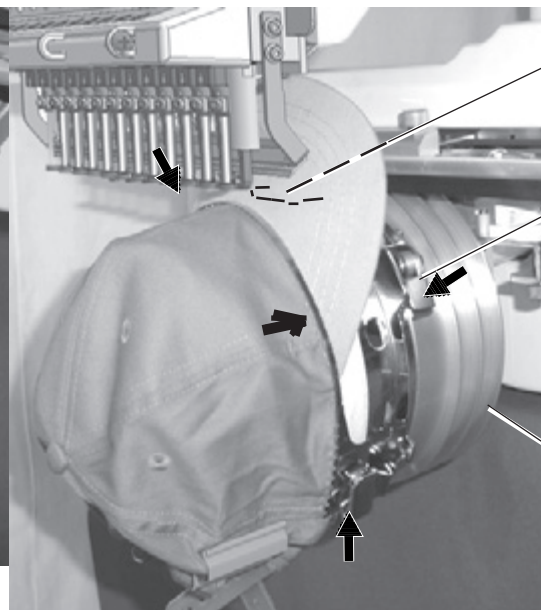
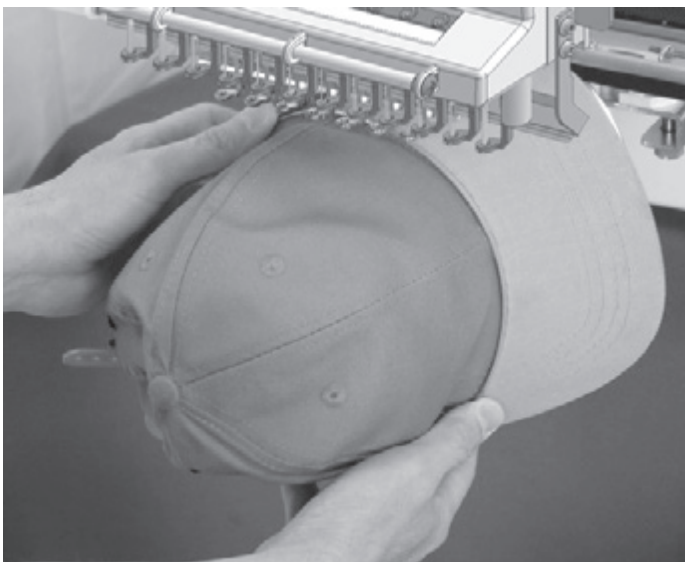


Fig. 2

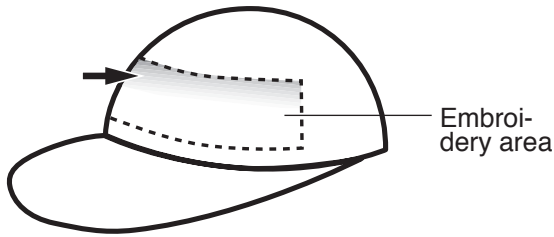
7. Remove the cap holder frame from the cap stretcher.
8. As shown in Fig. 5, place the cap holder frame the cap drive frame assembly. Push the hold lever in at 3 places as shown by the marks and place the cap holder frame so that center guide of the drive frame assembly gets in the upper cap holder frame.

Confirm that the cap holder frame is firmly attached to the cap drive frame assembly without any gaps. If there is a gap between cap holder frame and the cap drive frame, or hold lever doesn't go into hole on the cap holder frame well, loosen the set screw on the lever to adjust.

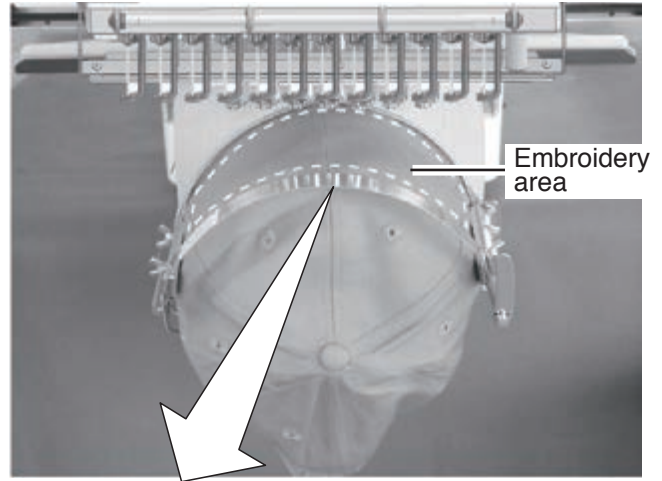
# CAP FRAME (OPTION)

# 7-B

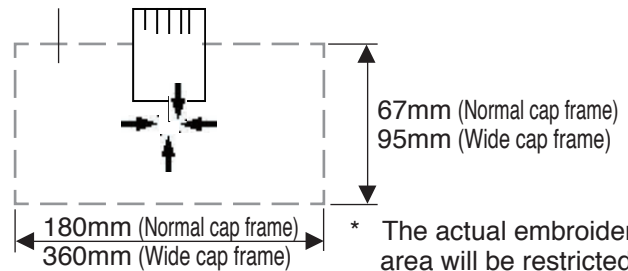
## Starting to embroider



There is a case that the upper part of the cap cannot be embroidered satisfactory depending on shape of a cap.  
We recommend to change design position or reducing size of the design.  
Refer to the instruction book of "Happy Link" to reduce the size of the design.

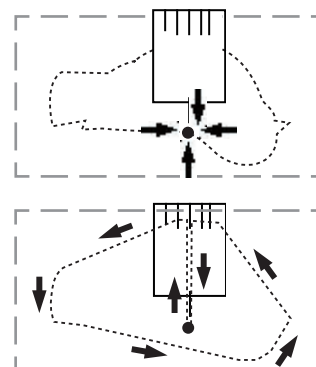


Embroidery area (Max. \*1)



\* The actual embroidery area will be restricted by the design and shape of a cap.

■:Original point (Start point)



You can confirm the outline



Backward only when pressing  
Forward only when pressing



Frame move      Pressure foot

1. Press and move the frame to the original point of pattern data by .

2. Press .  
After the moving head moves to the left end, the laser pointer will turn on.

**CAUTION: To prevent accidents.**  
The moving head will move.  
Please keep hands clear for your safety.

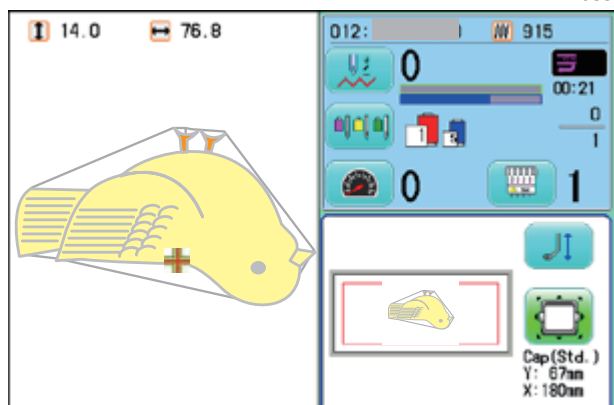
When you Press , the frame will start moving for the design trace. 10-4  
Make sure that the pressure foot and needle does not touch the frame.

When you Press , the machine will stop.


Go on to step 4 if you want to start embroidering without tracing first.

3. Press , the design trace finished.

The cap frame will return to the original point.





4. Press the .

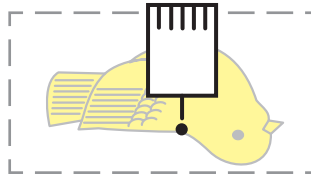
Embroidery will start.

5. After finishing your design, the display will show ">>End" and the machine will stop.

>>End

The embroidery frame will return to the original point automatically if the auto origin function has been activated.

●:Original point (Start point)

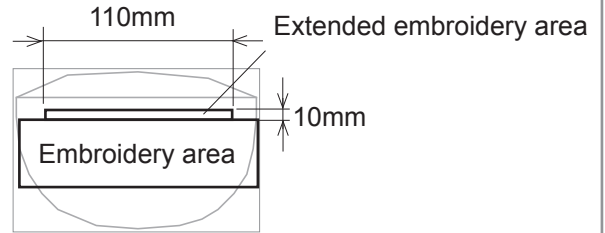


## Use of Y +10mm cap hold frame

As an option, a cap hold frame that is expanded 10 mm in the direction of the peak in the embroidery area can be used.

At this time, the expandable X-direction embroidery area is the central 110 mm.

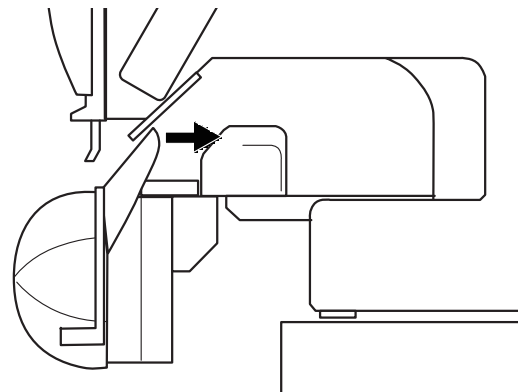
When using this frame, it is necessary to replace the special pressure foot and needle plate.



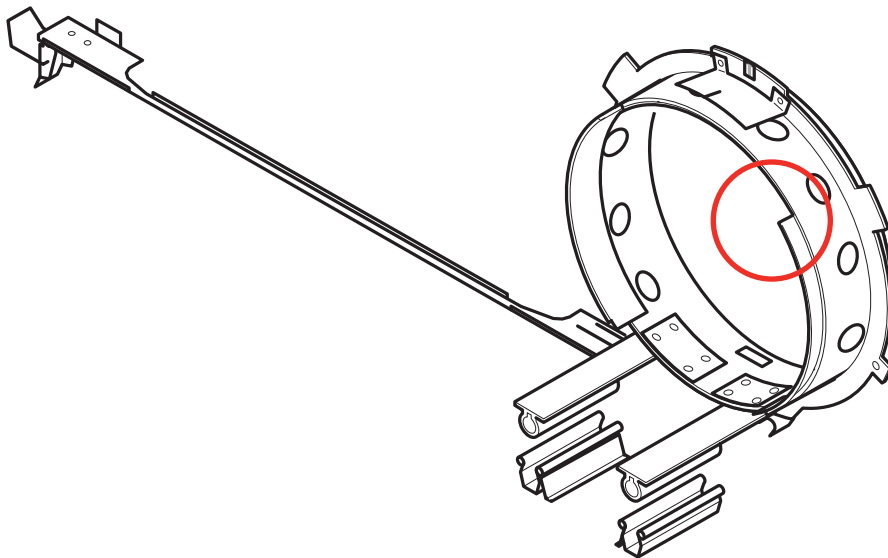
### CAUTION

Depending on the shape of the cap, if you embroider to the very bottom of the visor, the tip of the visor may hit the thread catcher of the embroidery machine strongly and causing problems.

Bend the visor by hand in the direction of the arrow before embroidering.



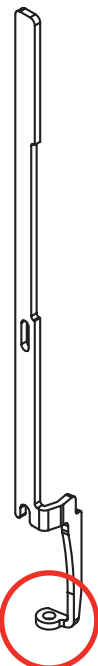
Y +10mm cap hold frame HCSU43A20



Needle plate for cap frame HCS43A10



Pressure foot for cap frame HCS43030




### ● Exchanging pressure foot

Please change all the needle bar pressure foot to the foot for cap frame by asking for your distributor or dealer in advance.

After replacing, you can use it as a standard pressure foot by returning the height of the pressure foot to its original position.

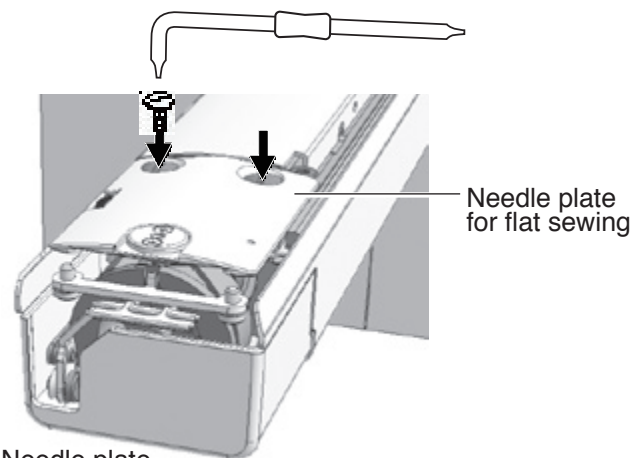
### ● Setting expand embroidery area

By operation of [MACHINE SETTINGS / 19 Expand cap limit  15-1b], extend the embroidery area by 10 mm in the peak direction.

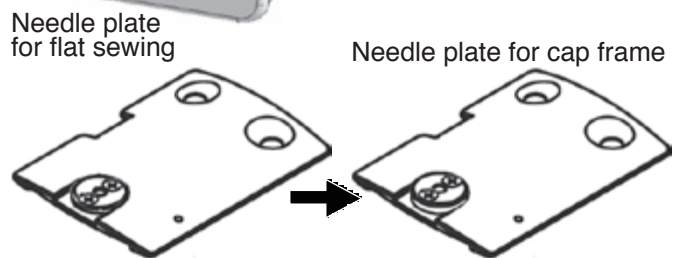
## ● Changing the needle plate


You need to use the needle plate for cap frame when you embroider a cap. When the cap frame is not used, it must be returned to the for flat sewing needle plate, and the height of the pressure foot must be adjusted to match the for flat sewing needle plate.

1. Remove the set screw (2 pieces) by offset driver and remove the for flat sewing needle plate.



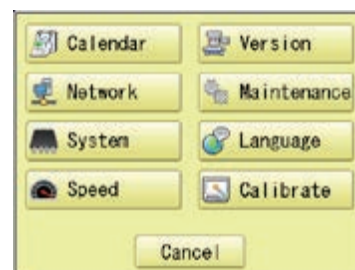
2. Put the needle plate for cap on the bed and tighten with the set screw.



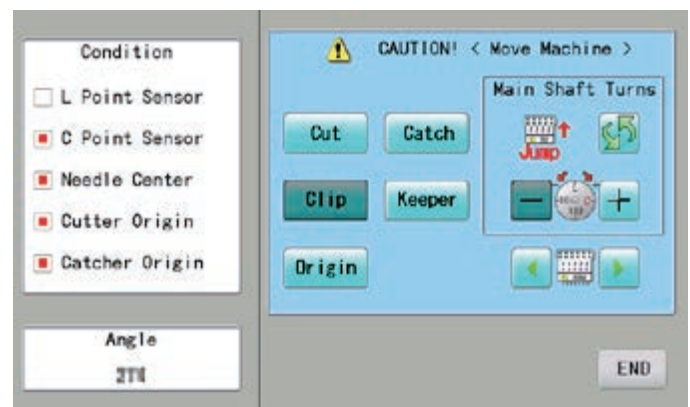
3. When the machine is stopped, press 




4. Press  "OTHER".



5. Press  Maintenance.



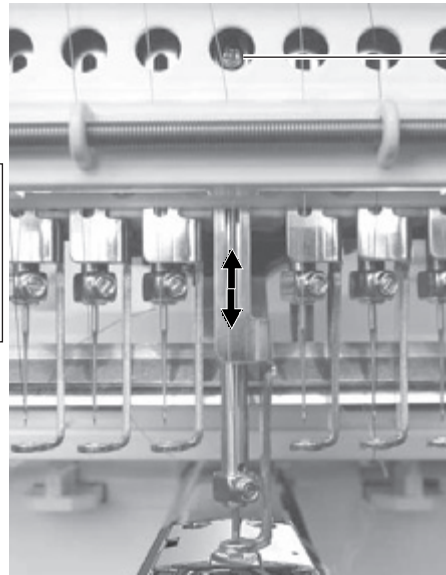
6. Press  to cancel "Jump".

7. Press and keep  until a fixing screw for pressure foot appears at the position as photo.



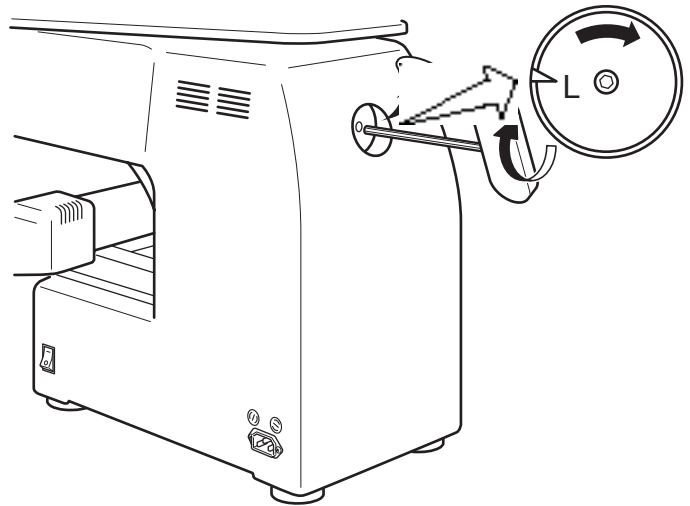
**CAUTION: To prevent accidents.**

The needle will down.  
Please keep your hands clear for your safety.

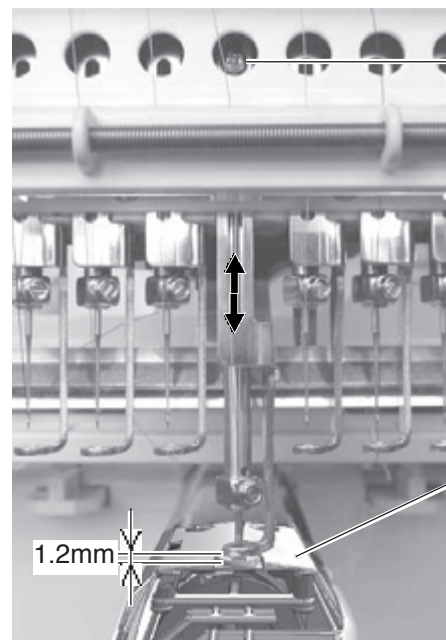


Fixing screw for pressure foot

8. Using a 3 mm hexagonal driver, Please turn the main shaft and adjust it to the "L" point.



10. Loosen a fixing screw for pressure foot. Adjust distance between pressure foot and a needle plate for cap to 1.2 mm. Tight a fixing screw.



Fixing screw for pressure foot

Needle plate for cap

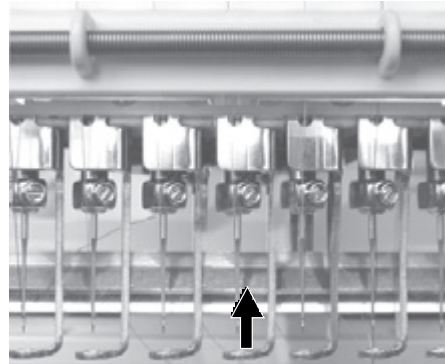
1.2mm

10. Press **Origin**.



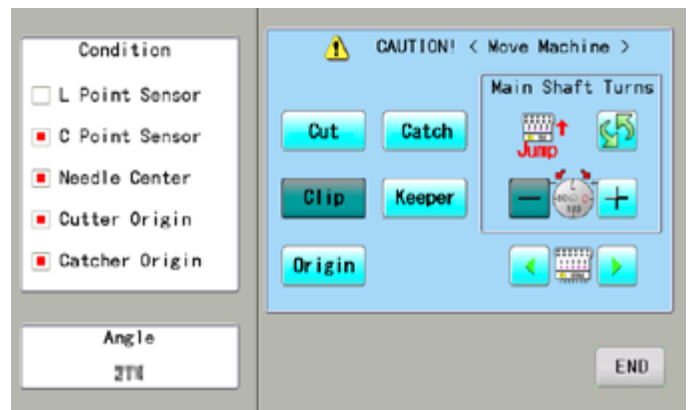
11. Press **OK**.

Pressure foot and needle back to standby position automatically.



12. Press    to select next Needle.

Repeat steps from 6 to 11, then adjust Pressure foot height of all needles.

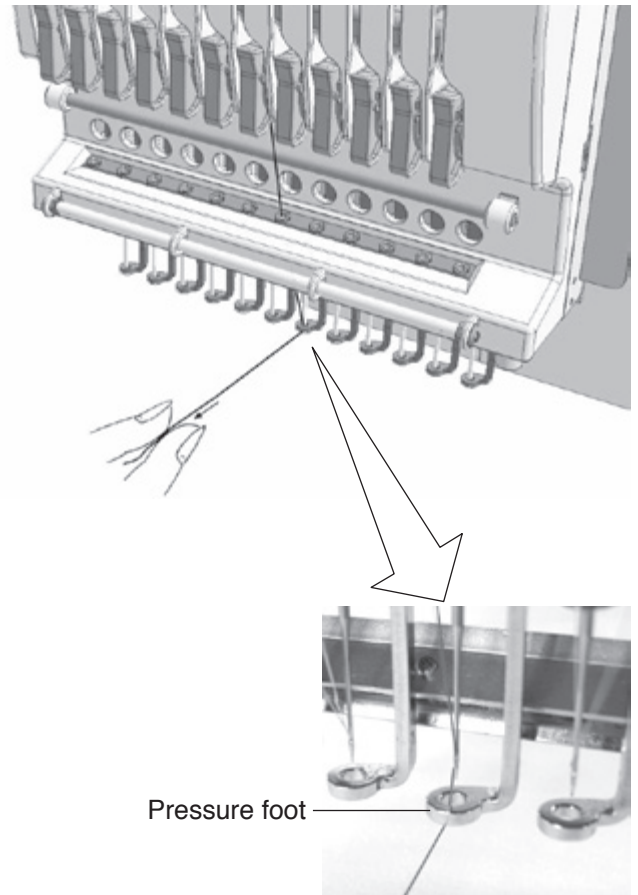


13. Press **END**.



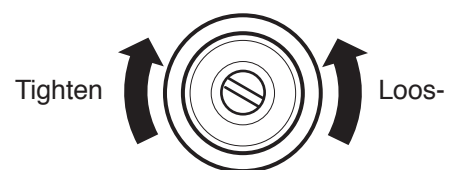
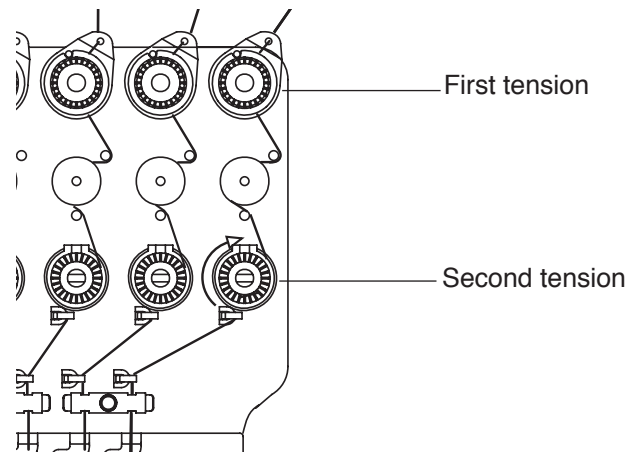
Press  to return to Drive mode.

1. With the thread going through the hole of the pressure foot, pull it out slowly toward the front.



2. Adjust the Minor thread tension by the first tension knob and then the second Thread tension knob.

According to the type of upper thread and cloth.



## ● What to do if the thread breaks while sewing

If the thread breaks or runs out while sewing, the machine senses the break, stops, and moves back several stitches from the break point.

(This prevents open sections in the design when sewing is resumed. See the thread break section. [P5-1](#))

### If the upper thread breaks

Thread the upper thread again.

(Refer to [P4-6](#))

### In case bobbin thread breaks

Thread lower thread again.

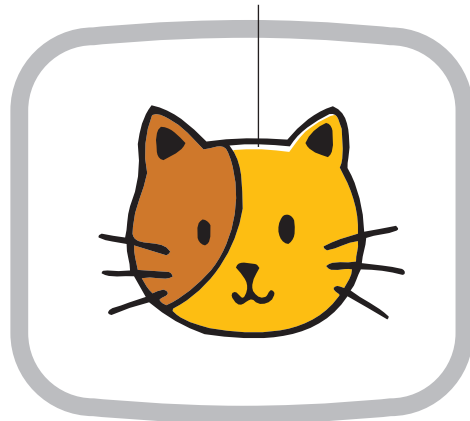
(See bobbin winding [P4-5](#))

## ● Stopping and resuming sewing

Even if you need to turn off the machine in the middle of embroidering, you will be able to resume sewing from the stop point after turning on the machine back on.

■ If you leave the machine off for too long, the fabric may distort which will create gaps in the embroidery design.

Example: An unsatisfactory gap between lines because the machine stopped at a half point in embroi-




### To suspend sewing

1. Stop the sewing by pressing the  button.

2. Press  button.

The needle will go down and trim the thread.

3. Press and hold .

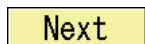
The power switch is automatically turned "OFF" and the machine is turned off.

>>Stop Switch





### To resume sewing from the last sewn position:


4. Turn on the power switch.

5. Press  button.

After the carriage and frame move slightly, the embroidery frame will return to the previous position automatically.

6. Press  and back up several stitches from the stop point by pressing the  3-4 times.

7. Press .

8. Start sewing again by pressing the .



### CAUTION: To prevent accidents.

When performing a thread trim, be careful of the needle which will pierce the fabric.



### CAUTION: To prevent accidents.

The frame moves quickly. Keep your hands and body clear of the machine.

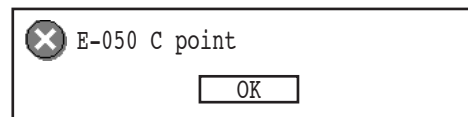
## ● Loss of power while embroidering

If you have a power failure while embroidering, follow these instructions and you can restore the position of the frame and the pattern data to its state before the failure.

1. Turn on the power switch.



2. Press **Next**.



3. Press **OK**.



4. Press **Auto**.

The main shaft will make one rotation and stop at the "C" point (proper stop position).





5. Press .


The needle will go down and trim the thread.

6. Press **Next**.

After the carriage and frame move slightly, the embroidery frame will return to the previous position automatically.

7. Press  and back up several stitches from the stop point by pressing the  3-4 times.

8. Press .

9. Start sewing again by pressing the .



### CAUTION: To prevent accidents.

When performing a thread trim, be careful of the needle which will pierce the fabric.




### CAUTION: To prevent accidents.


The frame moves quickly. Keep your hands and body clear of the machine.



## ● Moving the hoop while embroidering and then returning to the correct location

1. Stop the sewing by pressing the  while embroidering.

>>Stop Switch


2. Press  and move frame with



3. Press .

The frame will automatically return to the current sewing position.




 **CAUTION: To prevent accidents.**  
The frame moves quickly.  
Keep hands away from the frame.

4. Press .




## ● Moving back to the starting point (Origin)

The frame returns to the origin point (beginning position of design).

 **CAUTION: To prevent accidents.**  
The frame moves quickly.  
Keep hands away from the frame.

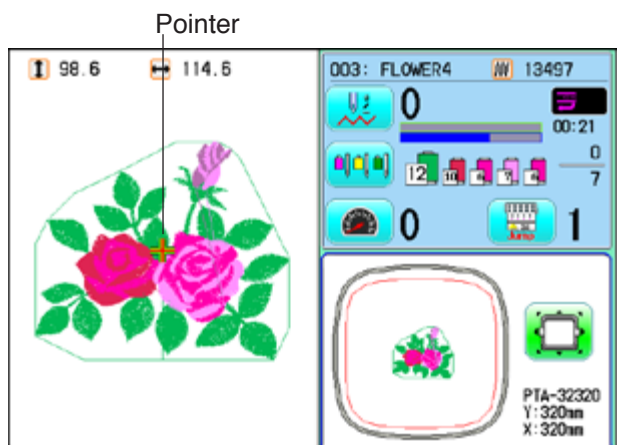
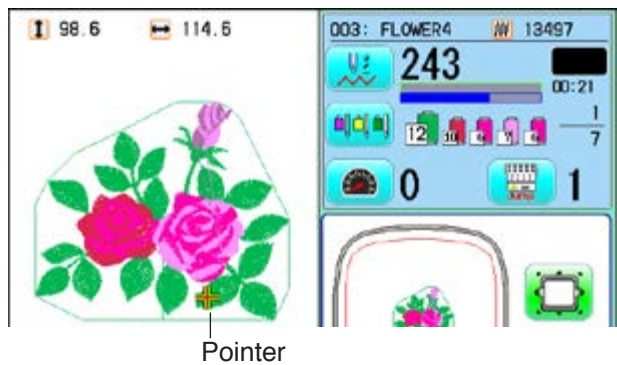
1. Press  and press .

The frame will move to the origin point and the pattern data will return to the start point.

 (Top) will be shown on the display.  
If you would like the frame to be restored to the previous state of origin point (before pressing ) , press  again.

 (Top) will be cleared on the display.

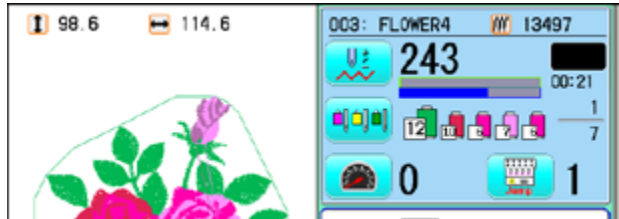
2. Press .





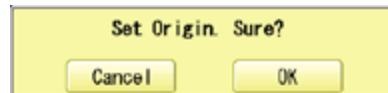
## ● Going back to the beginning of the design (Top)

Stopping sewing in the middle of a design, changing the design's location in the hoop, and then restarting from the beginning.

If you use "Top", you will return to the start point the frame position left where it is.




1. Press  and Press .

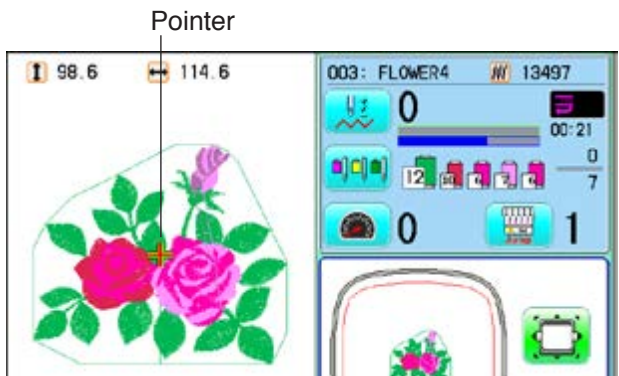


2. Press .

The pattern data will return to the start point.

 (Top) will be shown on the display.

3. Press .





## ● Placing the design in the center of the selected embroidery frame




### CAUTION: To prevent accidents.

The frame moves quickly.  
Keep hands away from the frame.

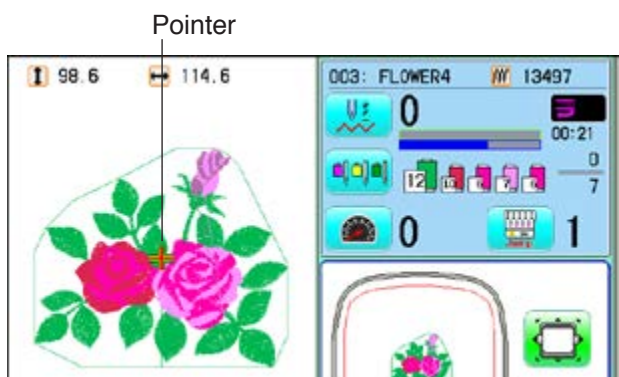
1. Press  and Press .

The embroidery frame will move to the center automatically.

If you want to get back to the previous status from "Center". Do procedure of  "Position".

 9-3

2. Press .




## ● Rotating and mirroring designs (Convert)


Convert selected pattern data.

**Setting example**

● : Start point of pattern



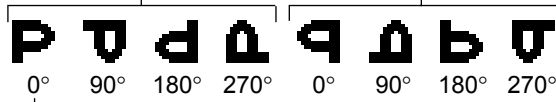
Normal



Mirror reverse + 90°


With the start point of pattern as a pivot, the machine changes the angle in 90 degree increments.

Normal                      Mirror reverse



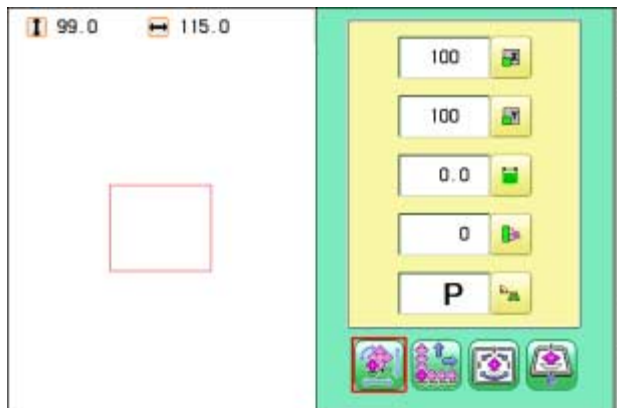
0°    90°    180°    270°    0°    90°    180°    270°

Normal angle

1. When the machine is stopped, Press 




2. Press  "SETTING".

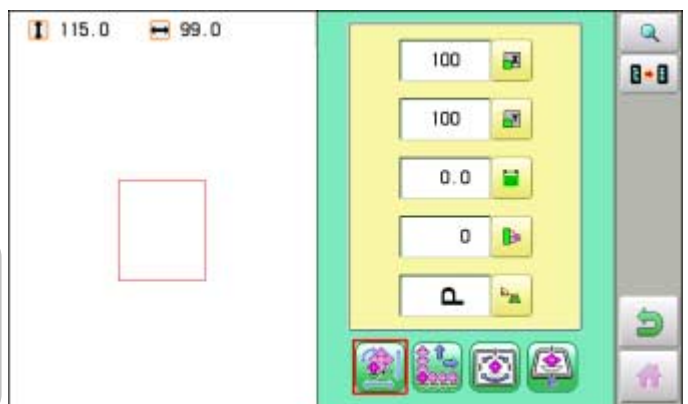



3. Press .




4. Press  to select conversion of position required.

The setting is fixed.



Press  to return to Menu mode.

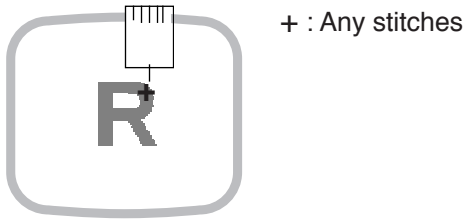
Press  to return to Drive mode.

## ● Starting in the middle of a design (POSITION)

This function allows you to go directly to a stitch number or a color change and positions the hoop correctly.

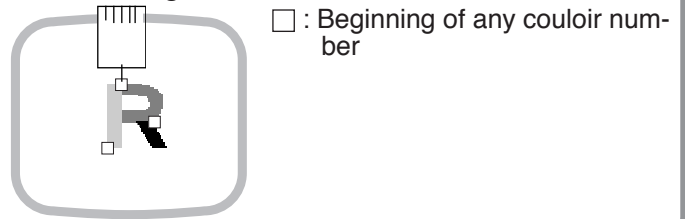
### Stitch (Number of stitches )

This moves the frame to any stitch number desired.



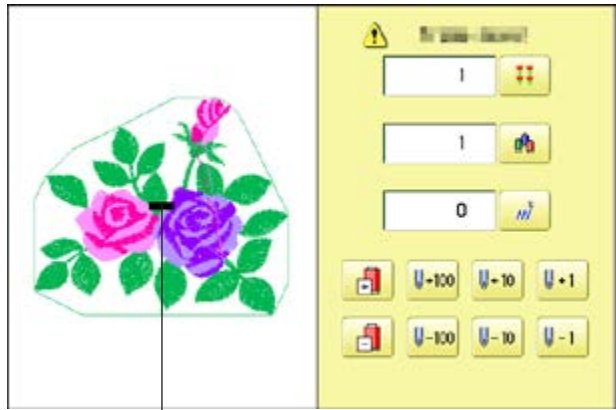
### Change (Color position )

This moves the frame to the beginning of any Color change number.



## Stitch

1. Press  "Frame forward".



Pointer shows you the current position of the frame.

2. Press .



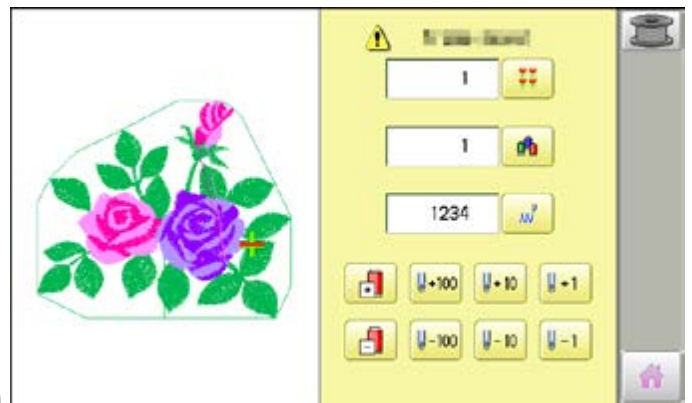
3. Input the stitch number and press .

The frame will move to the selected stitch number position.



### CAUTION: To prevent accidents.

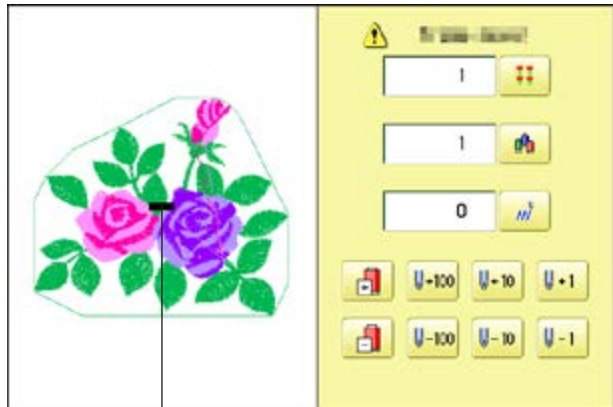
The frame moves quickly.  
Keep hands away from the frame.



Press  to return to Drive mode.

## Change

1. Press  "Frame forward".



Pointer shows you the current position of the frame.

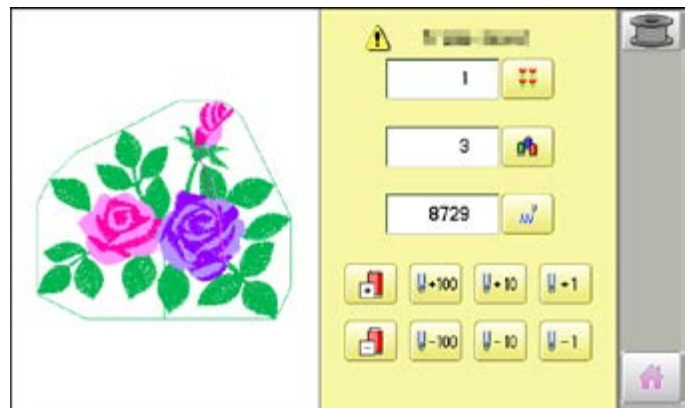
2. Press .





3. Input the color change number and press



The frame moves to the selected color position.



 **CAUTION: To prevent accidents.**  
The frame moves quickly.  
Keep hands away from the frame.

Press  to return to Drive mode.

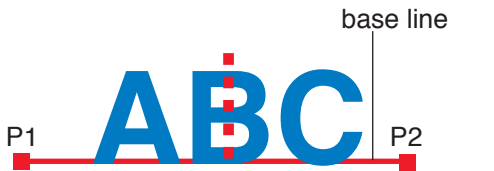
When embroidery position is aligned, machine automatically sets angle and embroidery only by defining 2 points (P1, P2).

This function is easy to align the position for embroidery on the edge of pocket or over seam of shirt.

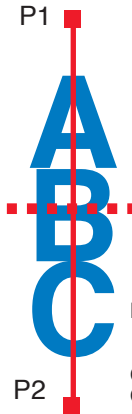
\*This function cannot be executed when repeat sewing " is set. [P](#) 14-5

\*This function is cleared when pattern with "Offset" is set. [P](#) 14-8

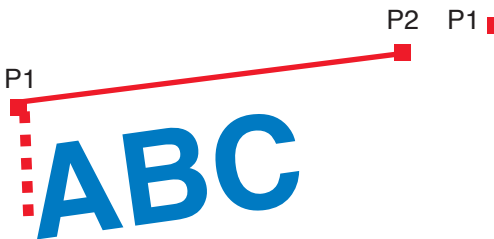
## Alignment Example



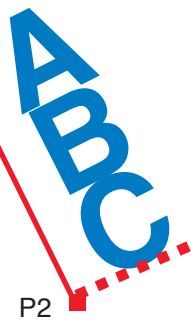
Method : Align pattern on base line  
Align pattern at the center of base line  
Offset of Y direction : none  
Offset of X direction : none



Method : Align pattern at the center of base line  
Align base line at the center of width of pattern  
Offset of Y direction : yes  
Offset of X direction : none



Method : Align pattern under base line  
Align pattern left of base line  
Offset of Y direction : yes  
Offset of X direction : yes



Method : Align pattern bottom of base line  
Align pattern at right side of base line  
Offset of Y direction : none  
Offset of X direction : yes

## Alignment Method

Align pattern with horizontal base line

Align pattern under base line			
Align base line at the center of height of			
Align pattern on			
Y dir. / X dir.	Align pattern left of	Align pattern at the center of	Align pattern right of

Align pattern with vertical base line

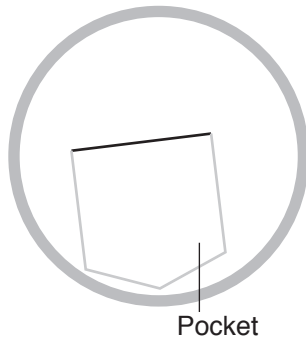
			Align pattern top of
			Align pattern at the center of
			Align pattern bottom of base line
Align pattern at right side of base	Align base line at the center of width of	Align pattern at left side of base	Y dir. / X dir.

# POSITION ALIGNMENT BY DEFINING 2 POINTS

# 9-9

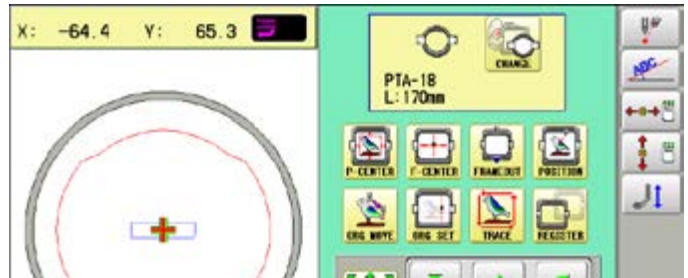
The procedure is explained as an example of embroidering pattern on pocket of shirt.

1. Hoop a shirt on embroidery frame.  
(Diagonal position of pocket on frame is okay.)  
Set the frame on the machine.



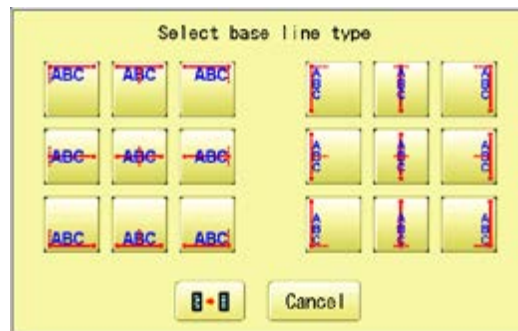
2. Press

Press and to turn the pointer on when laser pointer is installed.



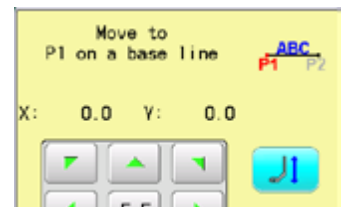
3. Press

When laser pointer is not installed, press to lower pressure foot and instructing position is identified easily.

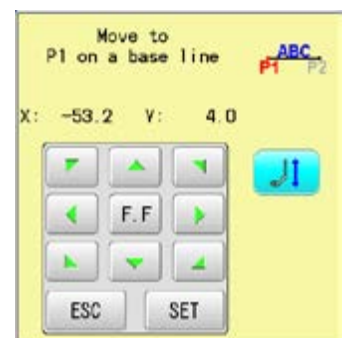
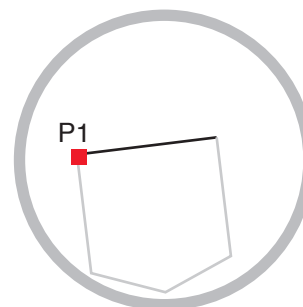


4. Select alignment method

Select in this case.



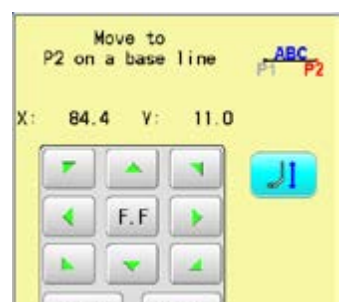
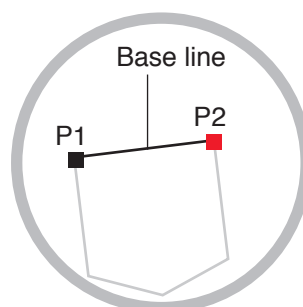
5. Move frame with and align the pointer or pressure foot on the left edge (P1) of pocket.



6. Press and move frame with



, and align the pointer or pressure foot on the right edge (P2) of pocket.



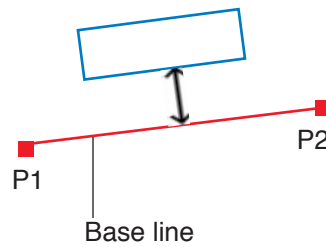
Line connected between P1 and P2 is base line.

# POSITION ALIGNMENT BY DEFINING 2 POINTS 9-A

7. Press **SET**.

Enter movement of arrow from base line (edge of pocket) to pattern.

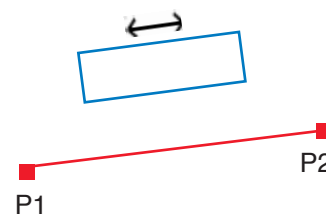
Enter "15.0"(15mm) in this case.



8. Press **SET**.

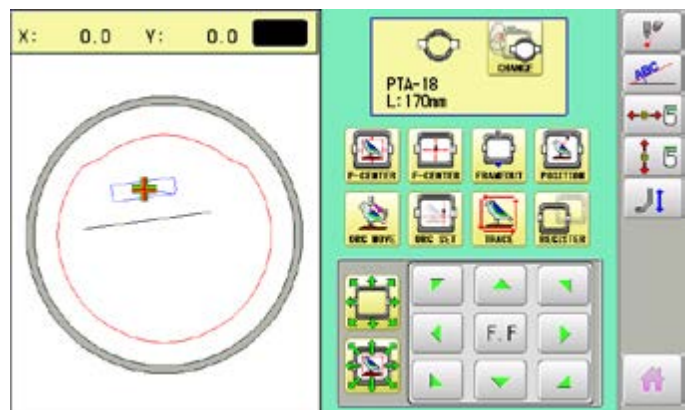
Enter movement of arrow from base line (edge of pocket) to pattern.

Leave "0.0" when pattern is aligned to the center of base line (width of pocket).



9. Press **SET**.

Complete



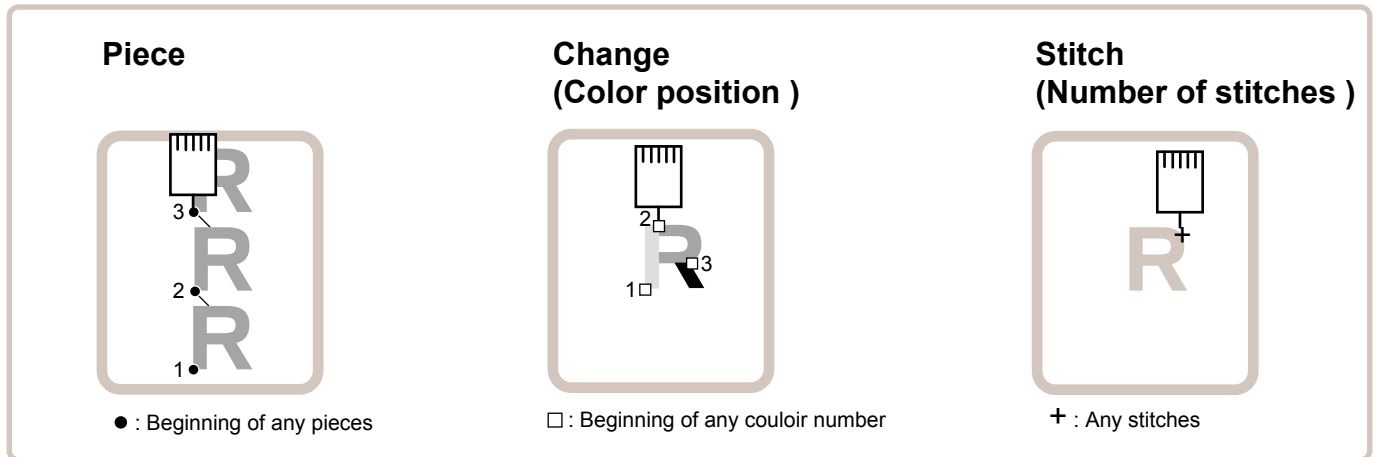
10. Press **HOME**.

Angle and position of embroidery are automatically set.





This creates direct designations to the number of stitches and \*color change number, as well as setting the frame and data to the designated sewing position.



## Piece

If "Repeat" is set, this allows the frame to move to the beginning of any piece at will.

- You can specify sewing position at specified pattern data number and specified number of stitch or color change number by entering the specified information.

## Change (Color position ) 9-7

This moves the frame to the beginning of any Color change number at will beginning of color.

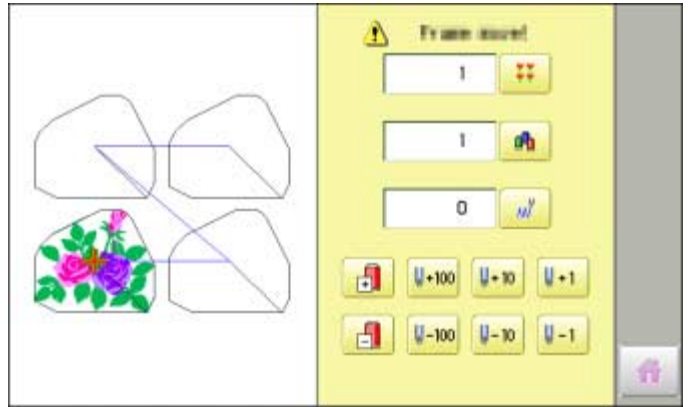
## Stitch (Number of stitches ) 9-6

This moves the frame to any stitch at will.

## Piece number

The frame and pointer can be moved a specified piece number.

1. Press  "Frame forward".




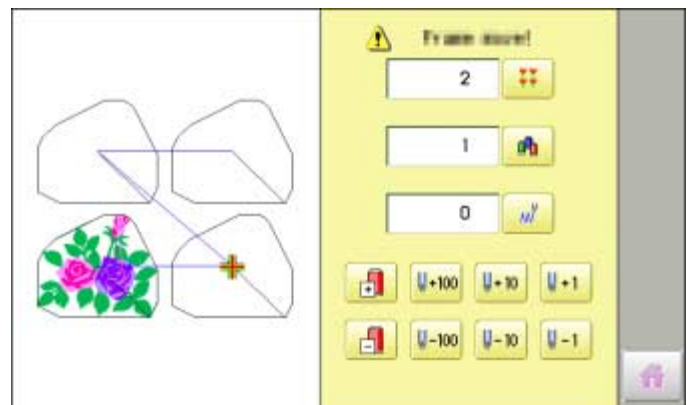
2. Press .



3. Input the number and press .

The frame and pointer will move to the specified piece number.

 **CAUTION: To prevent accidents.**  
The frame moves quickly.  
Keep hands away from the frame.

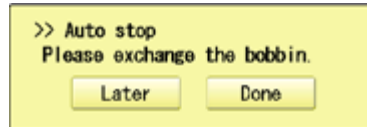


Press  to return to Drive mode.

## Bobbin thread alarm

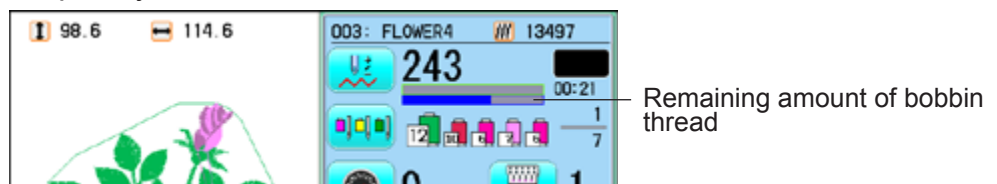
By entering the number of stitches per one bobbin, the machine can be stopped automatically when the remaining amount of bobbin thread becomes low.

Also, the alarm message will be displayed on the screen.



When the number of stitches is entered, the bobbin thread progress bar will be displayed just below the embroidery progress bar.

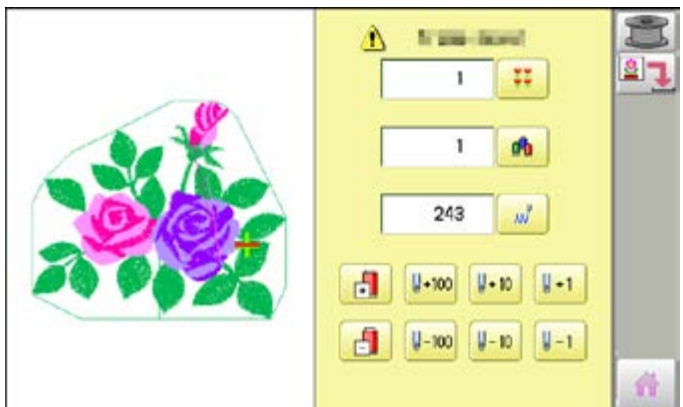
The bobbin thread progress bar shows rough remaining amount, and then the bobbin can be exchanged before empty completely.



## Setting

1. Press "Frame forward".

2. Press .



Setting value : Setting value: Register the number of stitches possible per one bobbin.

Current value : Current value: Display the current number of stitches after exchange the bobbin.

Press to reset the value.

: Setting value: Register the number of stitches possible per one bobbin.

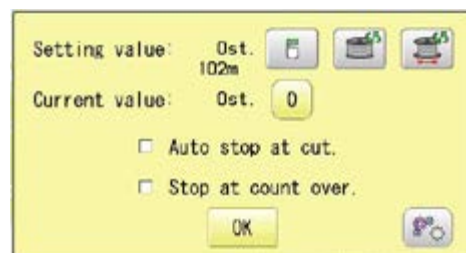
: The machine calculates the number of stitches that can be embroidered with one bobbin.


: The machine calculates the number of stitches that can be embroidered by inputting the remaining amount (diameter) of the bobbin thread.


Auto stop at cut. : sAuto stop at cut: The machine will be stopped automatically at first thread cut point after exceeding the preset stitches.

Stop at count over. : Stop at count over: The machine will be stopped automatically when the machine reaches the preset stitches.

: Set various conditions for the machine to calculate the number of stitches that can be embroidered. 9-Cc




3. Press  to set the desired number of stitches..

Input the stitch number and press .

The standard bobbin which is winded with #120 cotton thread will be used around 30000 stitches. But, the consumption of bobbin thread is varied depending on embroidery conditions such as stitch type, stitch length and thread tension. It is recommended to enter the value to 30000 stitches as first setting.





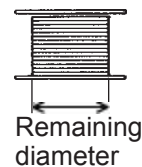
- Press  to have the machine calculate the number of stitches.

The machine calculates and sets the number of stitches according to various conditions set in




The machine calculates the number of stitches by the ratio of the sewing method such as satin or tatami in the currently selected pattern.

- Press  to have the machine calculate the number of stitches on the bobbin where the bobbin thread is not fully wound. Enter the remaining diameter of the bobbin thread and press .

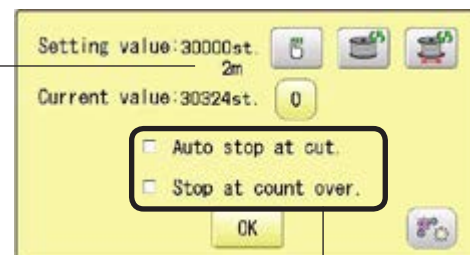


The machine calculates and sets the number of stitches according to the bobbin remaining bobbin thread amount and various conditions set in





The option of auto stop function can be selected () from "Auto stop at cut." and "Stop at count over.".

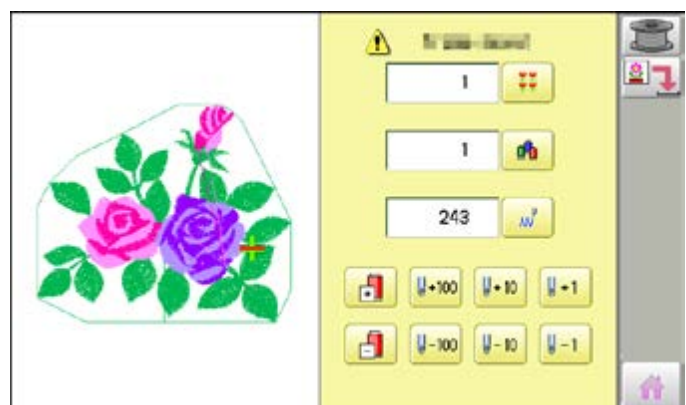
Remaining bobbin thread length



Auto stop option

4. Press .
5. Press  to return to Drive mode.

- The number of stitches that can be embroidered with one bobbin varies depending on the proportion of the sewing method such as satin or tatami in the selected pattern. If you select another pattern, set the "Setting value" again so that the bobbin replacement alert will be displayed at the appropriate time.





## Condition setting

In order for the machine to calculate the number of stitches that can be embroidered with one bobbin, set various conditions such as the size of the bobbin used and the diameter of the bobbin thread being wound.

After setting the required items, press **OK**.



Standard values are preset for each item.



Diameter of wound bobbin thread



Core diameter of bobbin



Internal width of bobbin



Length of bobbin thread wound



As a margin, advance the timing to display the alert by the length of the set bobbin thread.



When satin sewing is performed, the ratio of the width of the bobbin thread to the swing width when viewed from the back side.

## Setting correction

Correct the setting value to display the alarm message at proper timing.

1. Press **START STOP**.

During embroidery, the red progress bar which shows the remaining amount of bobbin thread will be extended until the preset stitches.

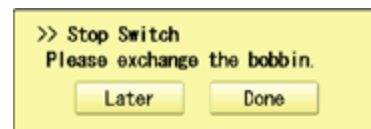
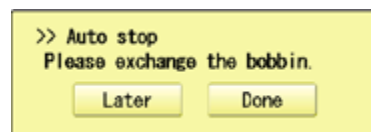
Remaining amount of bobbin thread



When the auto stop function is activated.

The machine stops automatically.

When the machine is stopped by manually.



2. Press **Later** when the bobbin is not required to exchange.

The setting value will not be reset and the stitch will be counted continuously.



Press **Done** when the bobbin is required to exchange.

The setting value will be reset to "zero" and the progress bar becomes blue.

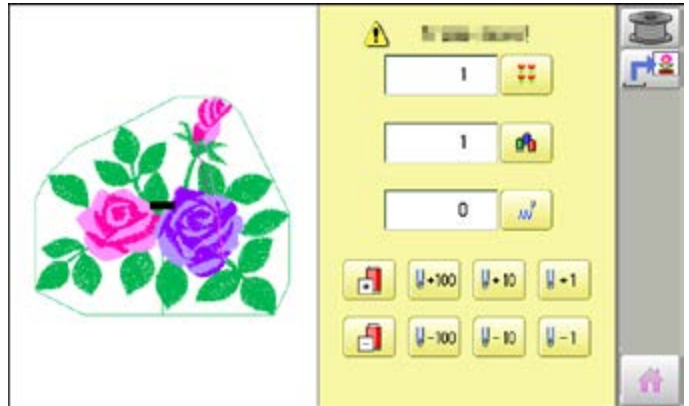


- Remove the bobbin and check the remaining amount.

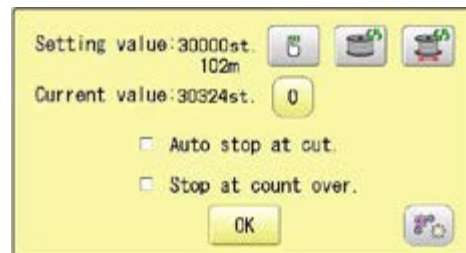
When the remaining amount is suitable, it is no need to correct the value.  
Please continue embroidery.

The correction of setting value is required when the remaining amount is overage or shortage.  
Go on to step 4.

- Press  "Frame forward".



- Press .



- Press .

- Reduce the setting value when the bobbin is almost empty.


Increase the setting value when the remaining amount is too much.



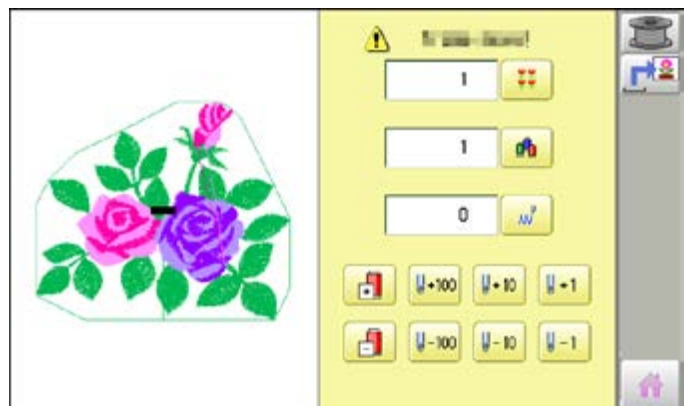
The total stitch number which is calculated after the last bobbin exchange is displayed as "Current value".

Please refer the "Current value" to find suitable setting.

- Press  and .

- Press  to return to Drive mode.

Please note that several corrections may be required to find suitable setting.



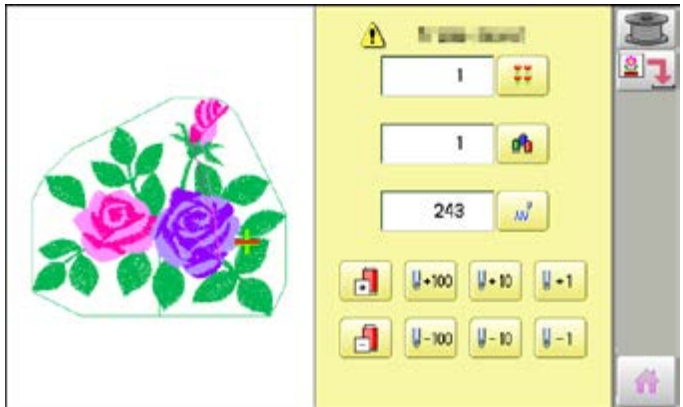
## Work save

You can save the state (before, during) of working design (the design displayed on the drive mode) and the selected frame type for the working design. This allows you to resume work by suspend sewing and returning to the state before the suspend of the driving design even after working other designs.

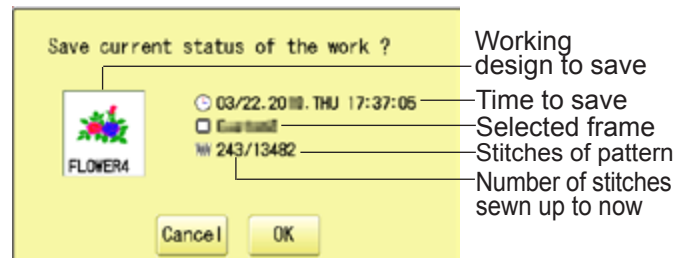
## Save


Save the state of working design and selected frame type.



1. Press  "Frame forward".




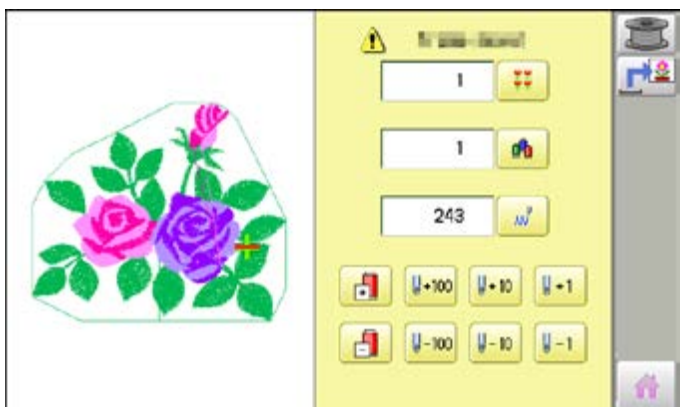
2. Press  "Save".




3. Press  .  
The state of working design and selected frame type have been saved.

 "Save" turn to  "Load".

 Saving is canceled.

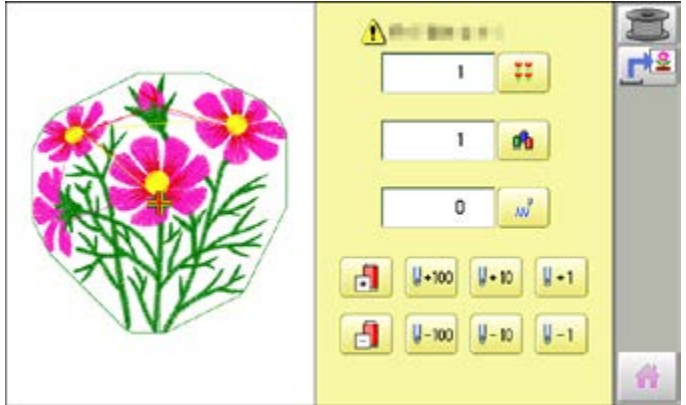


4. Press  to return to Drive mode.

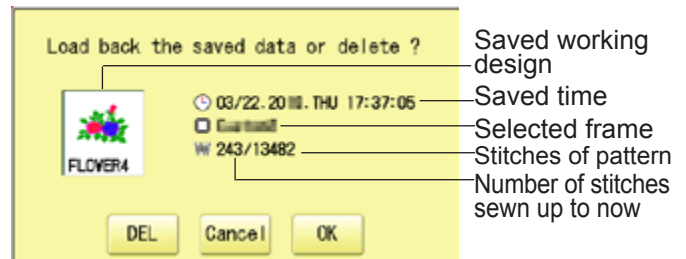
## Load

Loads the saved working design's state and the selected frame type, and restore it to the state before suspend sewing.

1. Press  "Frame forward".



2. Press  "Load".

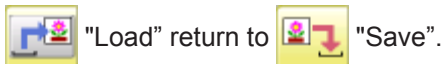



3. Press  .

The saved working design's state and the selected frame type are loaded, and restore it to the state before suspend sewing.

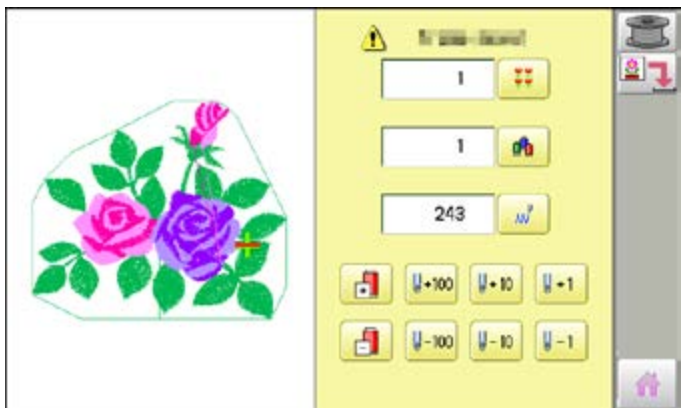
### **CAUTION: To prevent accidents.**


The frame moves quickly.  
Keep hands away from the frame.



 Loading is canceled and delete the saved state of working design etc.. (The memory design will not be deleted.)

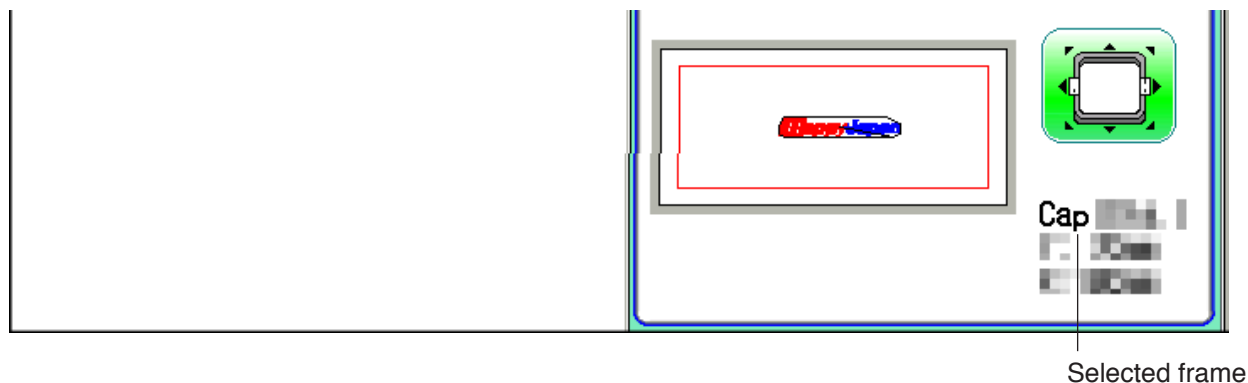
 Loading is canceled.



4. Press  to return to Drive mode.



Register will restore the position of the frame to the last point before a power failure even if the point of origin or the pattern itself were changed.



⚠ If register is used with a cap drive frame, make sure that the machine recognizes it by showing “Cap” (Cap frame) or “OnePoint” (One Point frame) the appropriate frame or the machine could be damaged.  
If register is used with indication of frames that do not require cap drive frame, carriage moves and exceeds embroidery area of cap drive frame and damages the machine and cap drive frame.

⚠ When you use “REGISTER”, keep clear of the frame and table. It is dangerous as the frame could make sudden movements.  
Never use register with the needle bar and presser foot lowered, as they could hit the cap drive frame and break.

- It is not always necessary to set “Entry”, but you can’t set “Return”. Once “Entry” is set, it is retained even if power is turned off.  
If you change the position of the original point, set it again.
- Even if you set “Entry”, the frame may not return exactly to the original position in process of time.  
Reset this monthly.

## Entry

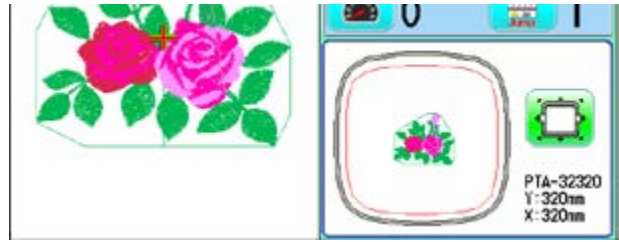
Registering the start point in the selected pattern.

## Return (Registered position)


When position of the frame changes because of power loss, this will restore the frame to the registered point.


## Entry


This registers the original point of the selected pattern.

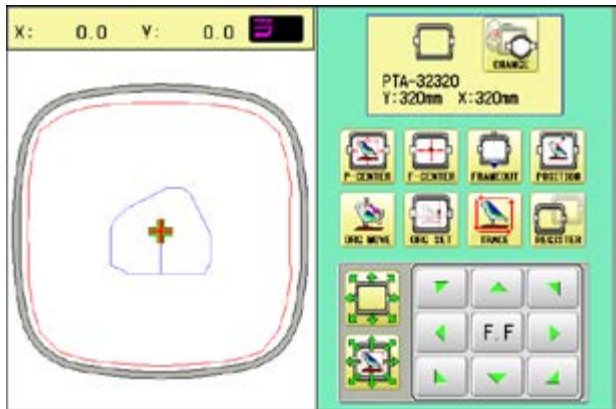


1. Press .

2. Confirm that there is indication of  (Top) in the display and go on to procedure no. 3.

Press  "Top", if there is not a indication.

Upper right indication of  will be shown.



3. Move the frame to the original point with the



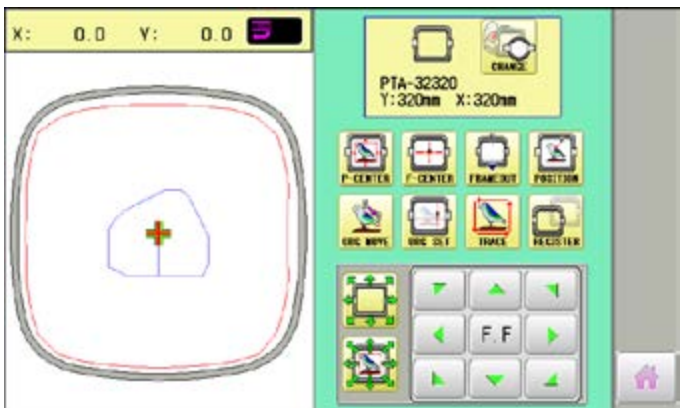
If the frame is located at the origin point, proceed to Step 4.

4. Press .



5. Press .


The origin point is registered.







Press  to return to Drive mode.

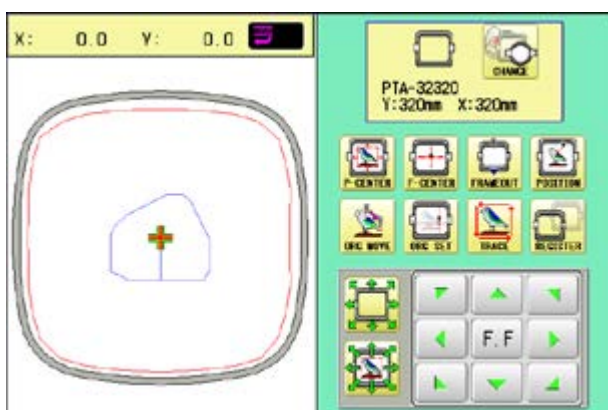
## Return

In case of power failure you can return to the original point you registered.

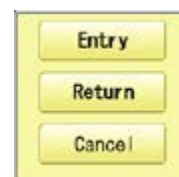
 **CAUTION: To prevent accidents.**  
The frame moves quickly.  
Keep your hands away from the frame.



1. Press .
2. Confirm that there is indication of  (Top) in the display and go on to procedure no. 3.  
Press  "Top", if there is not a indication.  
Upper right indication of  will be shown.

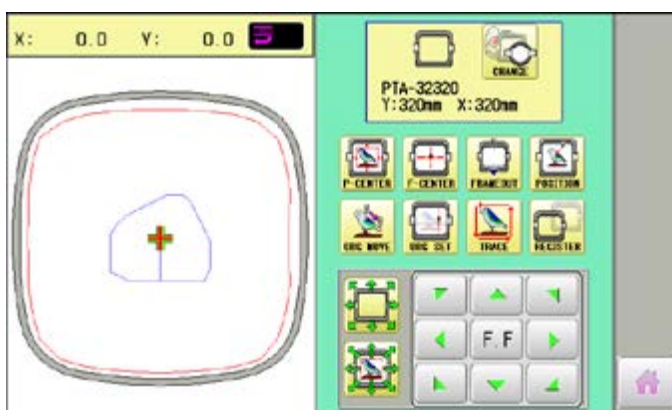


3. Press .



4.  press.

The frame will return to the origin point you registered.



Press  to return to Drive mode.

## ●Join

Joining 2 patterns into 1 pattern data to be read from a memory media.

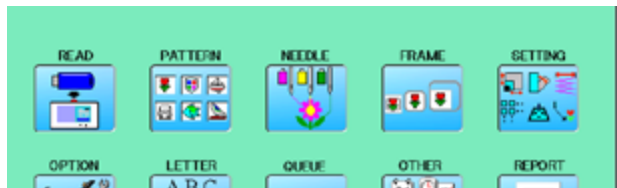
Function of joining patterns is not valid for pattern data in PC connected with LAN. 5-6

■ In case you would like to use “Join” function, please set “Join design data” to “YES” on “READING” setting in advance. 14-4

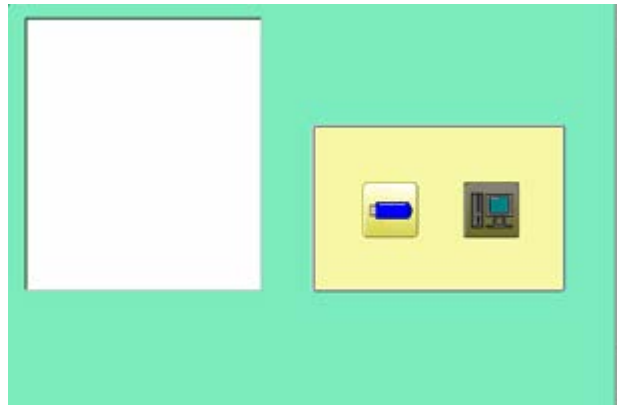
1. Insert the memory media into the machine as described in “Inserting memory media”.

5-5

2. When the machine is stopped, press .



3. Select “READ”.



4. Select (USB flash drive).

--- Serch pattern ---

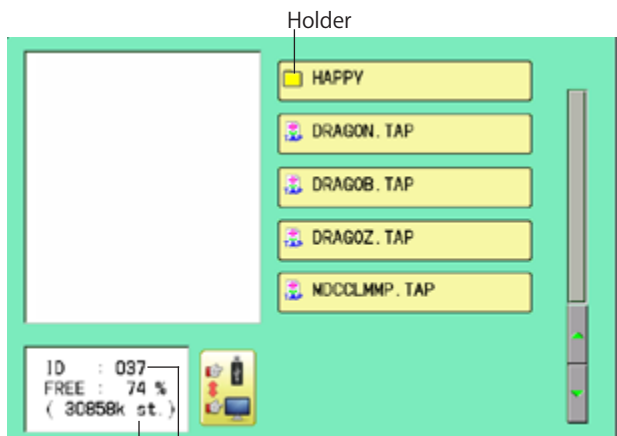
Indicates pattern data of the memory media.

- TAP : HAPPY
- DST : Tajima
- DSB : Tajima (Barudan)
- DSZ : Tajima (ZSK)

Folder : Contents of folder will be displayed when you select this icon.

1 % of free memory is equivalent to about 1,000,000 stitches.

If there are more stitches than remaining space, you may need to delete some designs to make room for the new patterns.



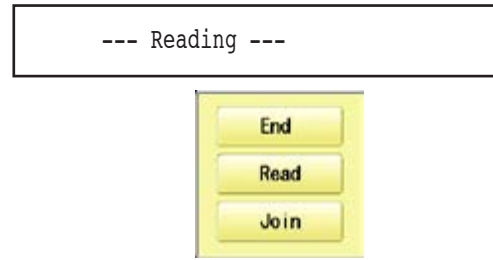
Free memory

The designs new ID number in

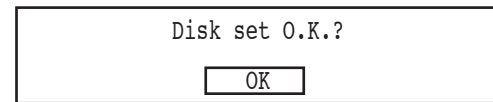
5. Select the pattern.

Once design is read.

Enable to read other pattern data.



6. Press **Join**.

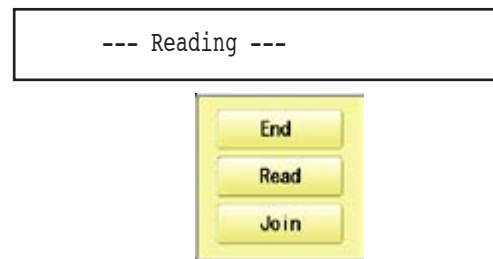


7. Press **OK**.

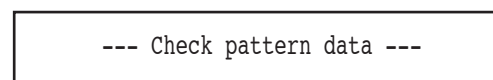
Shift the Memory media if the pattern data you desire to Join is in the other Memory media.



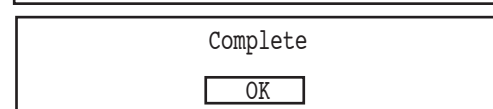
8. Select the pattern data to be Joined.



9. Press **End**.



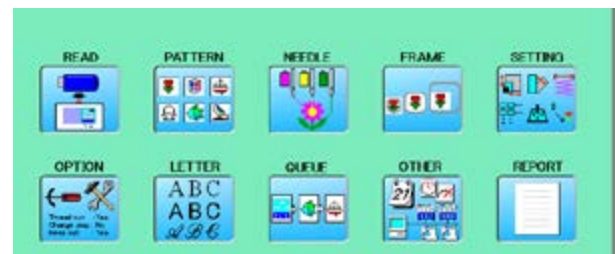
10. Press **OK**.





The pattern data selected to be joined is joined next to the pattern data previously read in the machine as one pattern data and the screen returns to Menu screen. Pattern name is registered as the name of the first pattern data read in the machine in pattern datum joined.

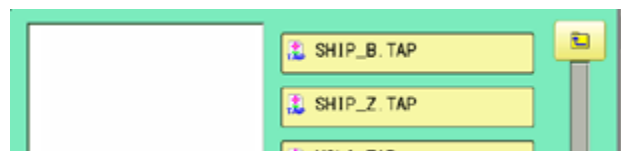
Press **Join** if you desire to join more patters.

Necessary pattern data can be read by performing step 6 to 10.





When the screen displays pattern data in the folder,  is displayed.

When  is pressed, the screen moves off from the current folder.



## ● Pattern read settings

Settings related to pattern data reading:

SETTING ITEM	SETTING RANGE (Default is underlined)	
1 Keep null (CHG.)	Yes• <u>No</u>	: This function lets the machine read zero stitches as they are before color change when reading pattern data.
2 Skip null stitch	Yes• <u>No</u>	: This lets you choose to ignore all null stitches when reading pattern data.
3 Combine jump	Yes• <u>No</u>	: Allows you to combine multiple, consecutive jump stitches when reading pattern data, if desired. It combines them into jump stitches of the maximum 12.7mm and reads the pattern with the combined jumps.
4 <u>Stitch sweeper</u>	<u>Yes</u> •No	: This function eliminates extremely short stitch for stitch width when reading pattern data.
5 Sweep length	0 ~ <u>0.4</u> ~ 0.8 (mm)	: This setting controls the length of the stitches eliminated by the Stitch sweeper. Stitches shorter than this setting will be eliminated.
6 DST name display	<u>Yes</u> •No	: When patterns in Tajima format are read in, the display shows the file name.
7 <u>Data format</u>	<u>Auto</u> →Automatic Happy→HAPPY, Tajima Brd →Barudan Zsk →Zsk	: Turn data format for reading patterns. Usually, set it to Automatic.
8 <u>Design information</u>	<u>Yes</u> •No	: This function reads various function setting which are set in pattern data together with pattern data (type TAP).
9 <u>Trace type</u>	 	: Lets you select the type of trace data that is created as a pattern is read in. → Maximum embroidery area of pattern → Out line
10 Join design data	Yes• <u>No</u>	: It is appeared that other pattern data is joined to the data previously read in the machine. You can make one pattern data by joining multiple pattern data read in the machine.
11 Folder select	Yes• <u>No</u>	: When reading pattern data, the list for selection of folders will be displayed.
12 Completion msg.	<u>Yes</u> •No	: Completion msg. will appear after reading pattern data.

## Detailed explanation of machine setting

### 4 Stitch sweeper

This removes stitches that are extremely narrow when reading pattern data and writing to machine memory. If thread breaks occur often at the same point in a pattern, this may be because of narrow stitches.

■ If the thread still breaks in the same place you can use this function again but repeated usage may distort the shape of the stitch.

1. Save the pattern to USB flash drive.
2. Conduct a stitch sweeping of the pattern and load it into the machine again.

End

### 7 Data format

This enables you to select a different format and read the pattern again if the machine did not read it correctly the first time.

### 8 Design information

\*Various settings are saved together with a pattern. If some settings are changed in the pattern and you wish to return to the originals, simply reload.

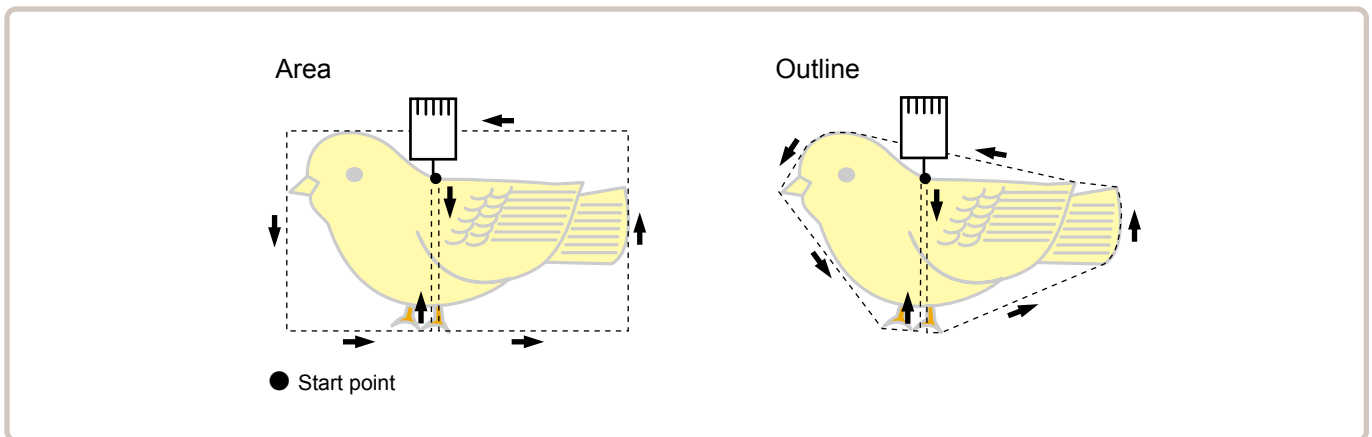
■ The data may only be HAPPY format (TAP).


### 9 Trace type

You can compare the design size and design position to the embroidery frame before you start sewing.

The embroidery frame will move around the actual design size.

At this time you can choose which type of trace from the two types as seen in the following figure:



1. When the machine is stopped, press  .



2. Select "OPTION".




3. Select  .



4. Select desired setting item and change the setting.

You can move to next page by pressing  .

Press  , all settings are returned to the default.


Press  to return to Menu mode.

Press  to return to Drive mode.



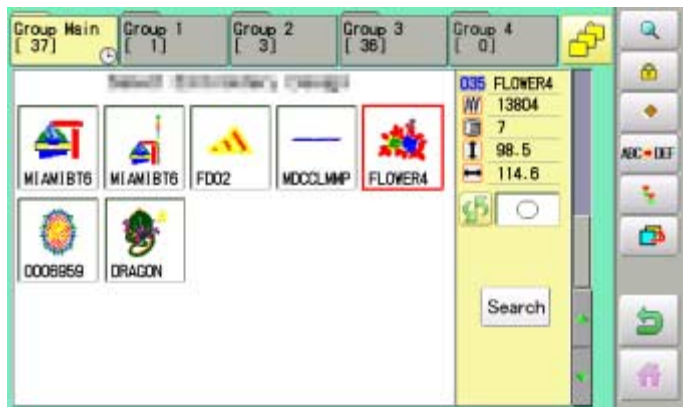
## ● Locking pattern data

Locking pattern data stored in the machine memory will prevent deletion and changes in settings.

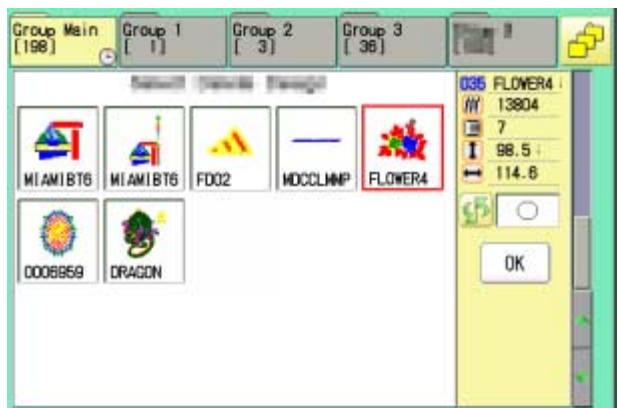
1. When the machine is stopped, press .



2. Select "PATTERN".

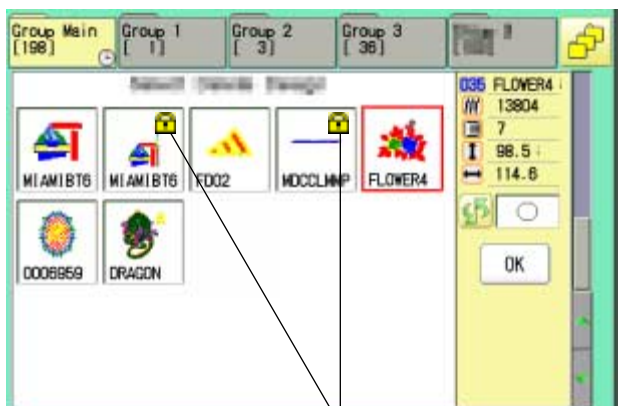


3. Press  from right submenu.



4. Select desired pattern.

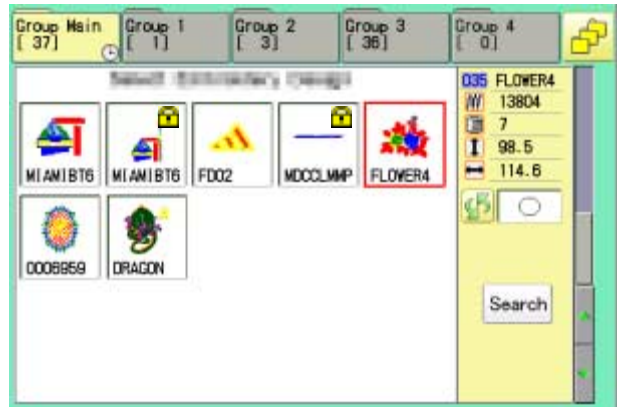
Mark will appear right of the pattern.  
 Make will be cleared by press it again.  
 Multiple pattern data can be selected.




Mark

5. Press .

Repeat steps 3 and 5 to unlock.



Press  to return to Menu mode.

Press  to return to Drive mode.

## ● Trace type

Changing the trace type of the pattern data in the machine memory. 10-4

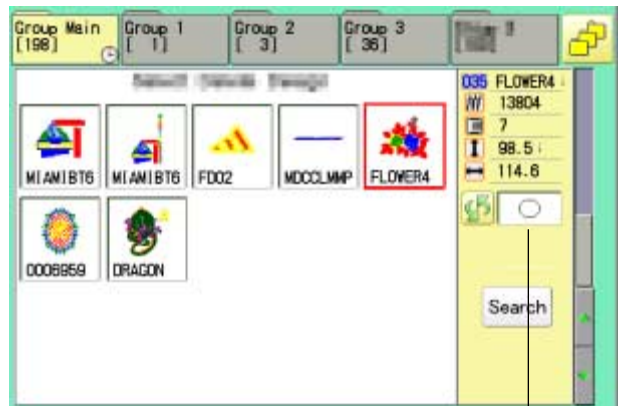
1. When the machine is stopped, press .



2. Select "PATTERN".

3. Select desired pattern.

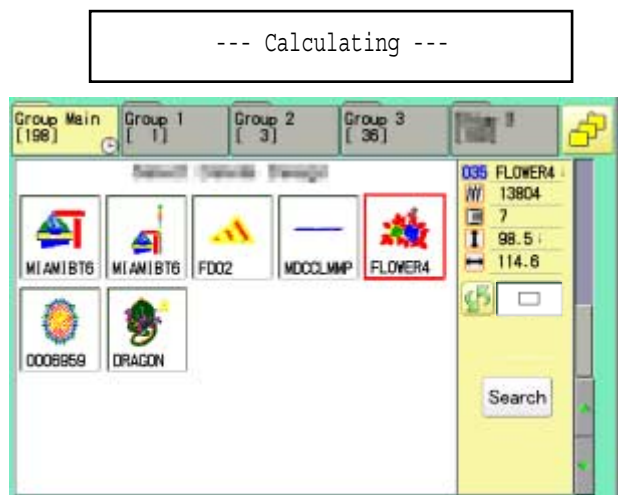
- Maximum embroidery area of pattern
- Outline of pattern



Trace type

4. Press and select or .

Trace type is changed.




Press to return to Menu mode.

Press to return to Drive mode.

## ● Export

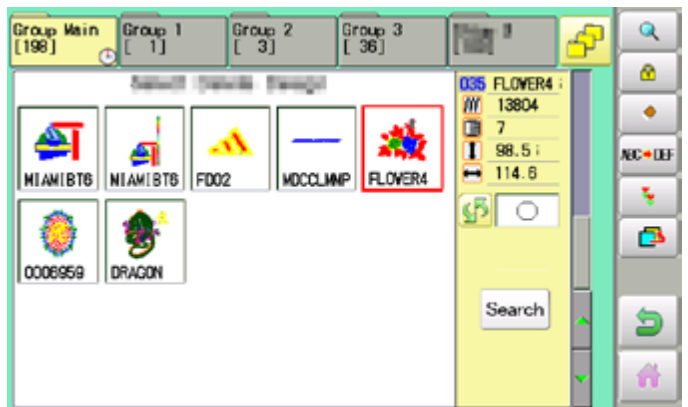
You can write out of machine memory to a memory media.

1. When the machine is stopped, press .

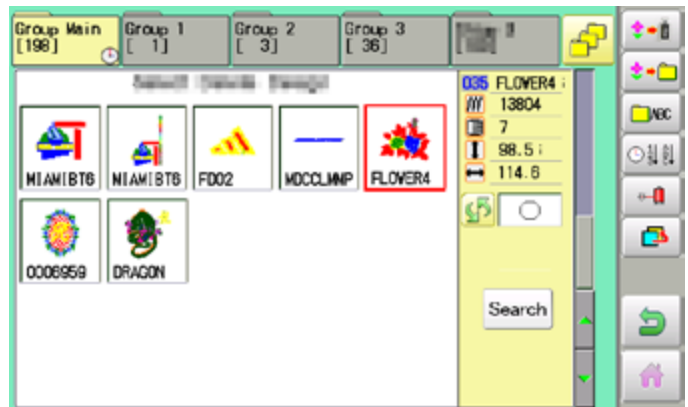


2. Select "PATTERN".

3. Select desired pattern.



4. Press  from right submenu.



5. Press  from right submenu.

The name of the pattern will be shown.



7. Press **SAVE** if the pattern name is not to be changed.

The pattern data will be written.

Choose the column with **◀ ▶**.

Then select each digit in the existing name.

Select word and press **SAVE**.

The pattern data will be written.

The maximum number of characters in a design name is eight letters or numbers.

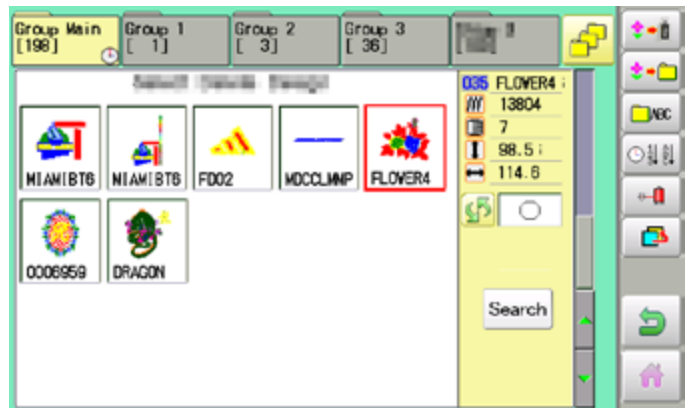
**CLEAR** All the letters and/or numbers are deleted.

**DEL** Selected letter or number is deleted.

**CANCEL** Changing name is cancelled.



The display returns to the view of Step 5.




Press **↶** to return to Menu mode.

Press **🏠** to return to Drive mode.

## ● Renaming patterns

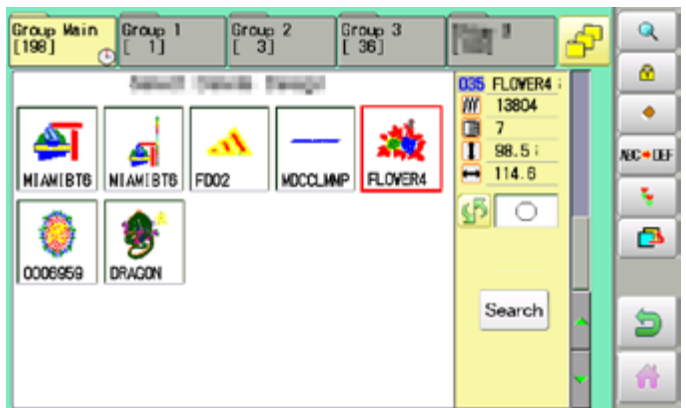
Rename pattern in memory.

1. When the machine is stopped, press .





2. Select "PATTERN".

3. Select desired pattern.






4. Press  from right submenu.



5. Choose the column with  .
- Then select each digit in the existing name.  
Select word.

The maximum number of characters in a design name is eight letters or numbers.

-  All the letters and/or numbers are deleted.
-  Selected letter or number is deleted.
-  Renaming is cancelled.

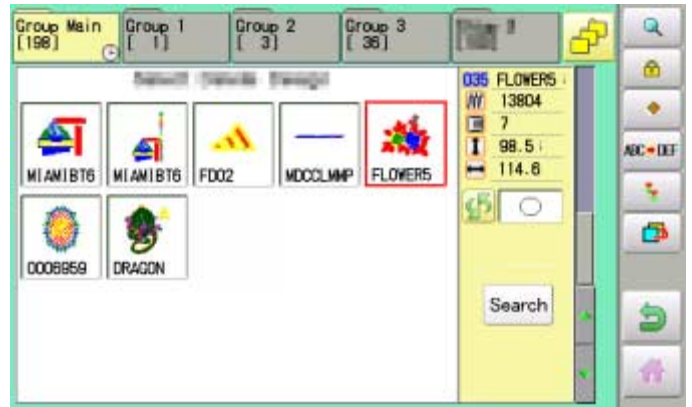



# PATTERNS IN MEMORY

# 11-5b

6. Press  .

The pattern name will be changed.




Press  to return to Menu mode.

Press  to return to Drive mode.

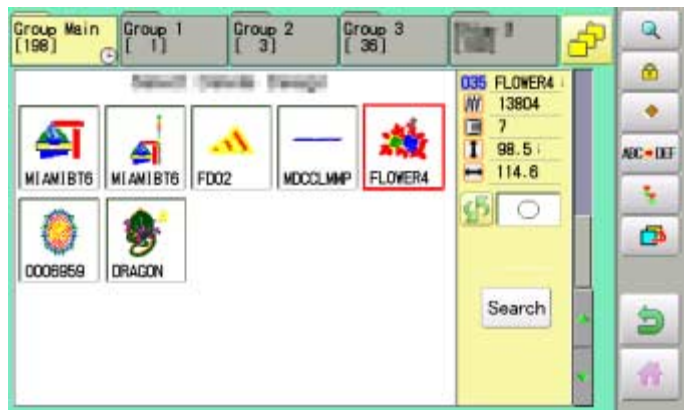
## ● Copying pattern data

Copying of the pattern data stored in the machine memory is available.

1. When the machine is stopped, press .



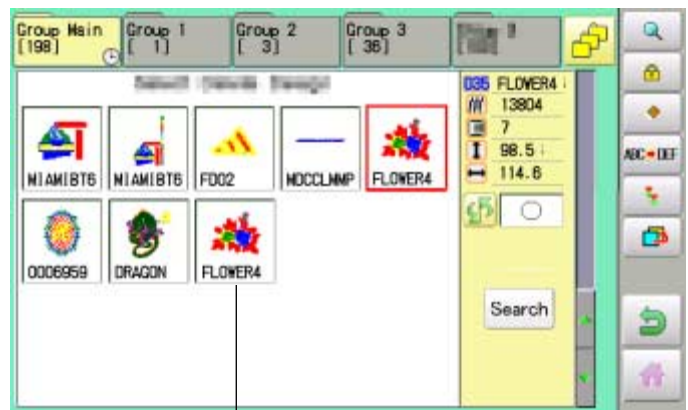
2. Select "PATTERN".



3. Select desired pattern.


4. Press  from right submenu.

Copy of the selected pattern will be made.



Copied pattern data


Press  to return to Menu mode.

Press  to return to Drive mode.



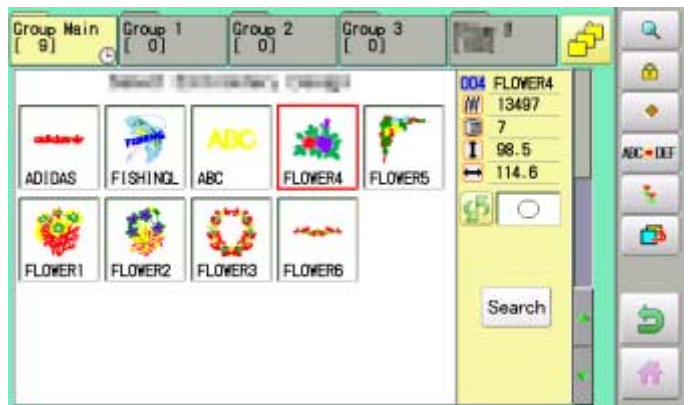
## ● Moving pattern data

Export pattern data into the other folder.

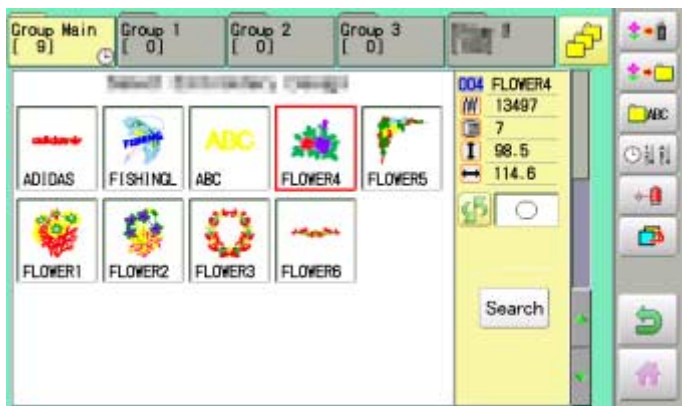
1. When the machine is stopped, press .



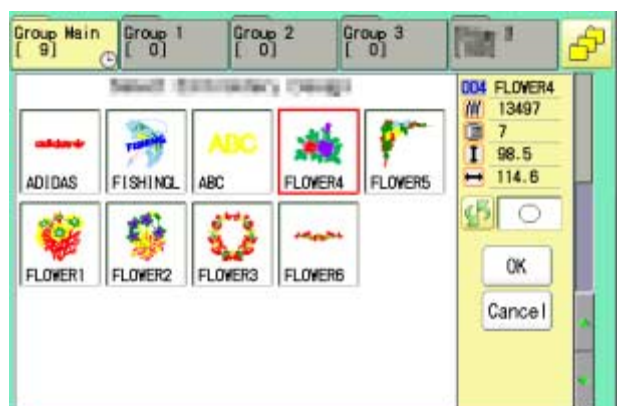
2. Select "PATTERN".



3. Press  from right submenu.



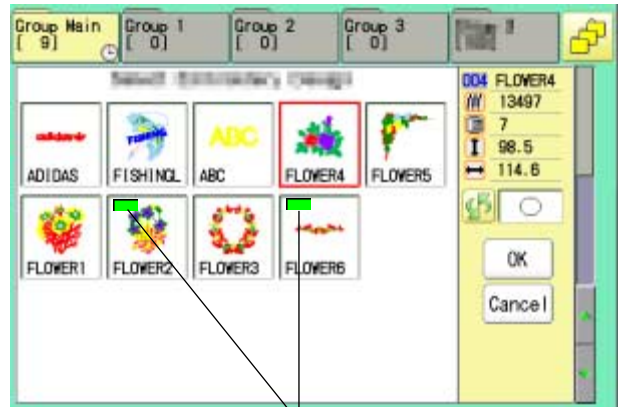
4. Press  from right submenu.



## 4. Select desired pattern.

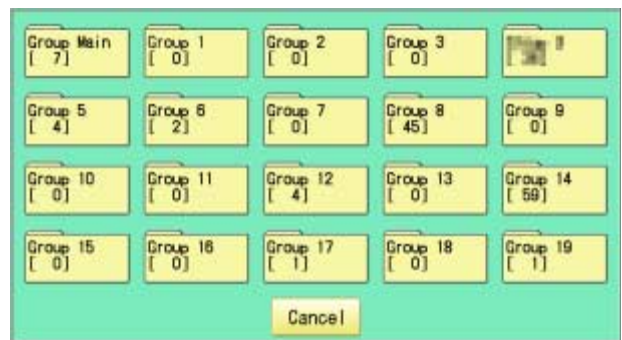
Mark will appear left of the pattern.  
 Make will be cleared by press it again.  
 Multiple pattern data can be selected.

**Cancel** : Cancel pattern data moving



Mark

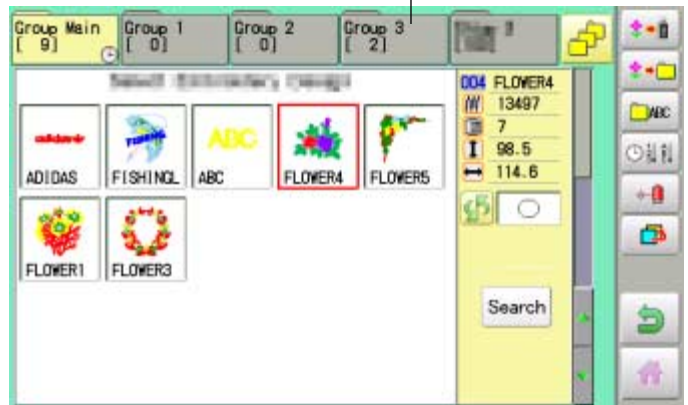
## 5. Press **OK**




## 6. Select the importing folder.

The pattern data will be transferred.

Importing folder




Press  to return to Menu mode.

Press  to return to Drive mode.

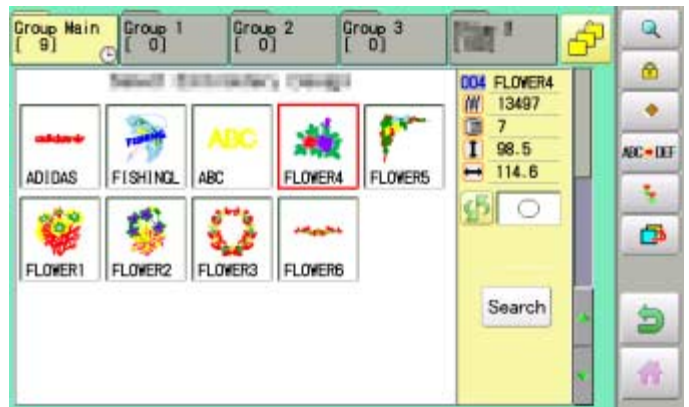
## ●Renaming folders

Rename folder in memory.

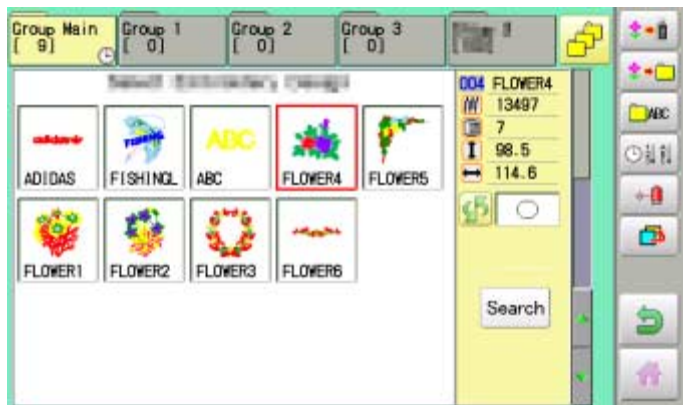
1. When the machine is stopped, press .



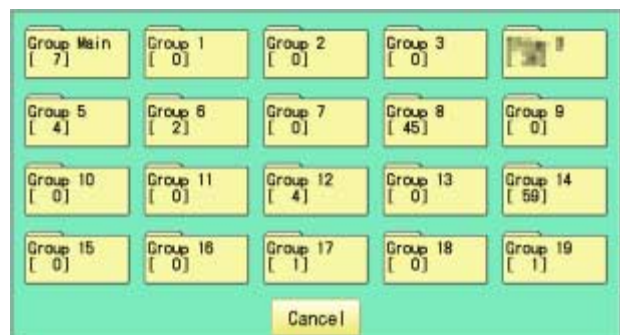
2. Select "PATTERN".



3. Press  from right submenu.





4. Press  from right submenu.







5. Select desired folder.



6. Choose the column with  .  
Then select each digit in the existing name.  
Select word.

The maximum number of characters in a design name is 12 letters or numbers.

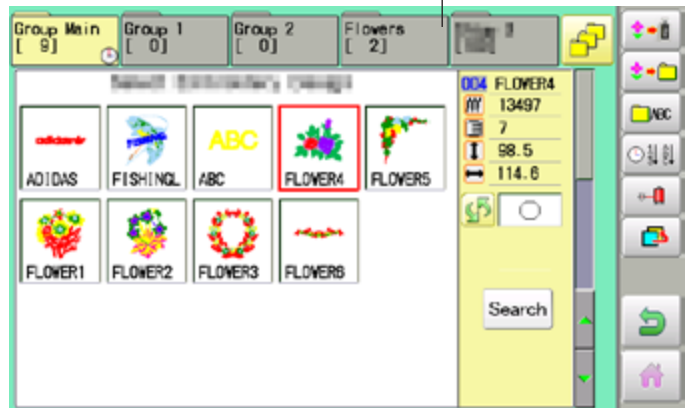
-  Uppercase and lowercase letter are switched.
-  All the letters are deleted.
-  Selected letter or number is deleted.
-  Renaming is cancelled.



7. Press .

The folder name will be changed.

Renamed folder




Press  to return to Menu mode.

Press  to return to Drive mode.

## ● Sort

Ordinate the pattern data in the displayed folder.

1. When the machine is stopped, press .



2. Select "PATTERN".



3. Press  from right submenu.



4. Press  from right submenu.



To sort in ascending order of loading



To sort in descending order of loading



To sort in ascending order of pattern number



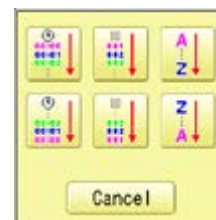
To sort in descending order of pattern number



To sort in ascending order of name of pattern




To sort in descending order of name of pattern




## 5. Select sorting method.

Sort will be carry out.




Press  to return to Menu mode.

Press  to return to Drive mode.

## ● Thread break report

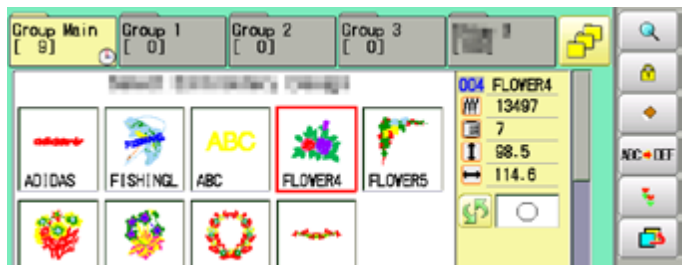
This function will show recorded thread break of pattern data. The machine detects break thread during operation and records by pattern the number of stitches at the stopped position. If thread break is happening at same number of stitches, please check construction of stitch design.

1. When the machine is stopped, press .

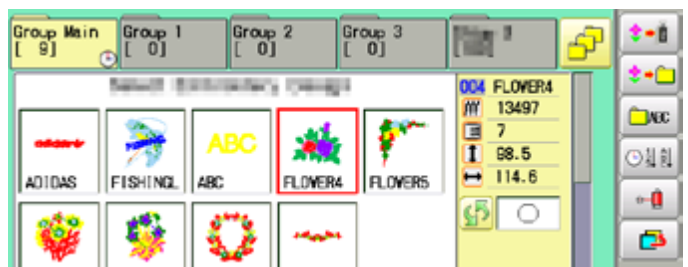


2. Select "PATTERN".

3. Select desired pattern.



4. Press  from right submenu.



5. Press  from right submenu.

Thread break report will appear in the window. The maximum memory is up to No. 30. If the record exceeds No. 30, the new records will be added to the latest 29 records.

 To delete the record

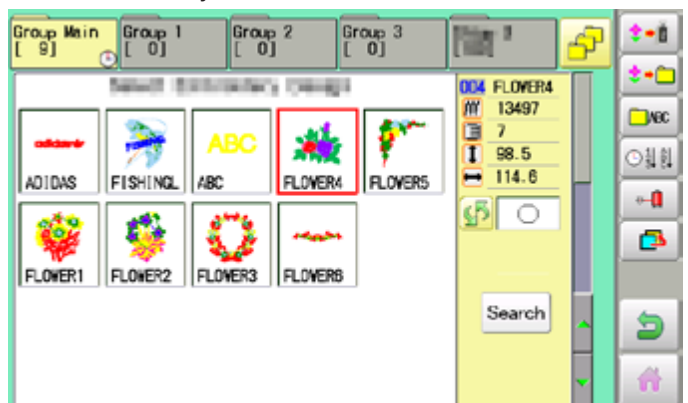
Pattern number  
Pattern name  
Number of stitches

009 FLOWER4 ( 13497)					
No	No	No	No	No	
1:	0	11:	0	21:	0
2:	0	12:	0	22:	0
3:	0	13:	0	23:	0
4:	0	14:	0	24:	0
5:	0	15:	0	25:	0
6:	0	16:	0	26:	0
7:	0	17:	0	27:	0
8:	0	18:	0	28:	0
9:	0	19:	0	29:	0
10:	0	20:	0	30:	0

Number of stitches at the stopped position by thread break

6. Press .

Exit the mode.



Press  to return to Menu mode.

Press  to return to Drive mode.

## ● Retrieve built-in data from machine

100 pattern data are built-in in machine and you need to retrieve built-in pattern data from machine memory to design data folder. These pattern data are stored in the [Group 4] folder on the PATTERN screen.

Empty the [Group 4] folder before built-in pattern data are retrieved from machine memory.

Built-in pattern data cannot be retrieved if there is any pattern data in the [Group 4] folder.

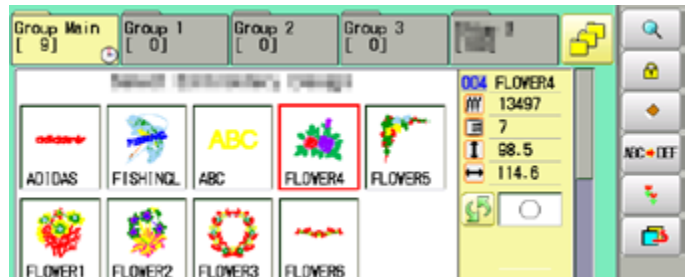
Built-in pattern data can be moved to other folder and/or deleted like monogramming data made on LETTER screen and other pattern data imported from outside of machine. 11-7, 5-B

You can retrieve the pattern data from machine memory again after deleting the built-in data.

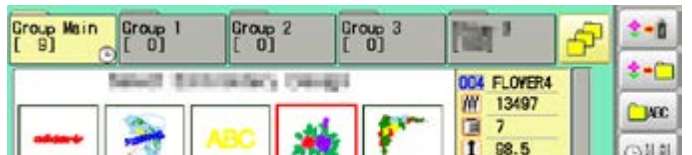
1. When the machine is stopped press



2. Select "PATTERN"

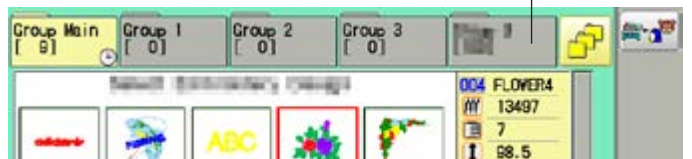


3. Press from right submenu.



Right side folder

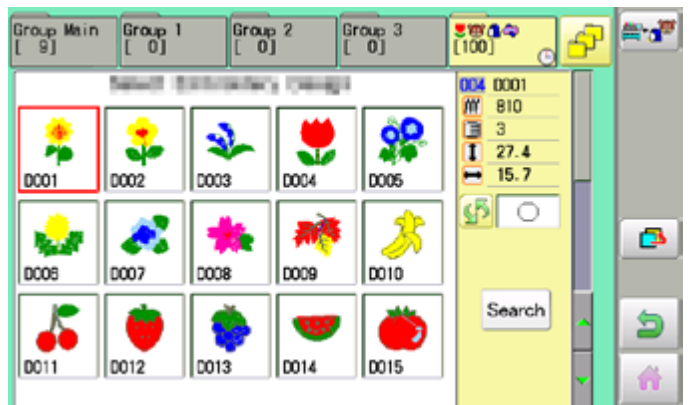
4. Press from right submenu.



5. Press from right sub-menu.

Retrieving pattern data is started.  
It takes several minutes to complete data retrieving.  
100 built-in data is shown on page 26-4.

--- Reading ---



Press to return to Menu mode.

Press to return to Drive mode.



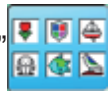
## ● Searching pattern data

Searching of the pattern data stored in the machine memory is available.

1. When the machine is stopped press 




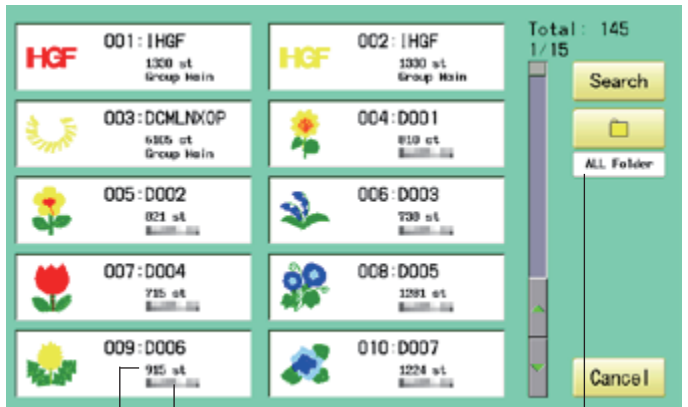
2. Select "PATTERN"



3. Press 

All pattern data stored in the machine memory will be displayed.

 Search from designated folder.



Stitches

Display the folder name to search

The folder name which the pattern is saved

Cursor





4. Press 

In this keyboard for searching, all design names are checked beforehand and only candidate alphabets will be highlighted along respective digits.



5. Enter the whole or a part of the pattern name.

The maximum number of characters in a design name is eight letters or numbers.

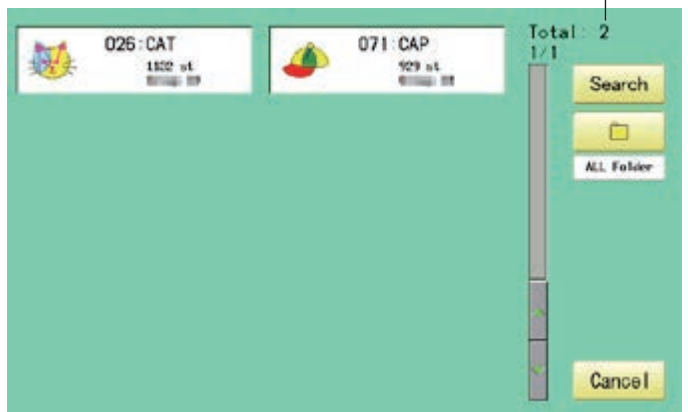
-  All the letters and/or numbers are deleted.
-  The letter is deleted before the cursor position.
-  Cancelled.
-  The search will start.



6. Press .



In this example, "CA" is entered as first 2 characters of the design name. Then, all design name which start from "CA" is displayed.

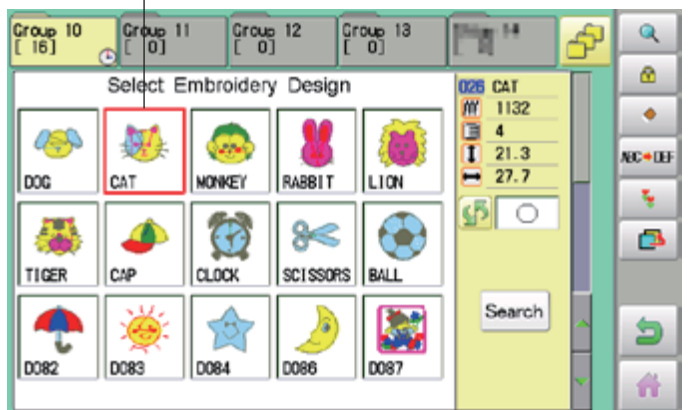
Number of searched pattern data



7. Press displayed pattern icon to confirm your selection.

Selected pattern data

- Press  to return to Menu mode.
- Press  to return to Drive mode.



## Needle number settings 5-E

A needle number can be assigned to a \*color change number.

When the needle number is assigned, the machine will embroider and automatically switch to the programmed for each color change number.

## Color change stop function 5-F

A \*color change stop can be assigned to a color change number.

When this is done, the machine embroiders the stitches for that color change number and then stops, displaying the following message:

>>Change Stop

## Auto setting

Changes all designated needle numbers at once.

## Thread color

This sets the background color or color assigned to each needle bar to be shown in the display.

## Color change data registration, Color change data read

You can use the color change data from a saved pattern, register it, and then export the registered data to the selected pattern for use.


## Repetition of color group setting

If your design has repetition of the group of the same color sequence, only set first sequence and set other automatically by following steps.

## ●Auto setting

This changes all designated needle numbers at once.

For example, if you want to change all needles numbered “3” to “5”, just select one of the color change numbers in which “5” is set, then all color change numbers can be changed into “3”.

1. When the machine is stopped, press .



2. Select “NEEDLE”.



3. Press  from right submenu.

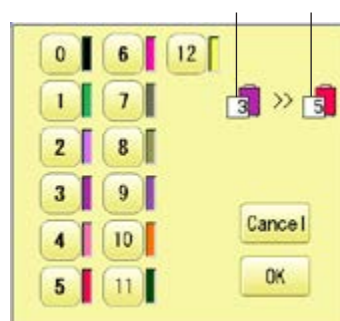


4. Select the current needle number you would like to change.



5. Select the needle number to be changed.


Needle number      Needle number to




# NEEDLE BAR SELECTION

# 12-3

6. Press .

 Setting is cancelled.

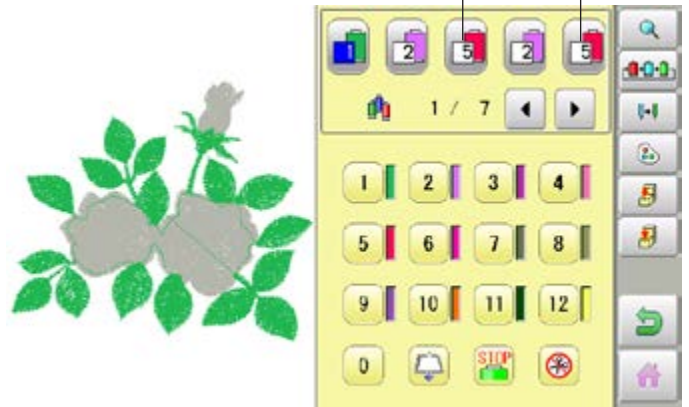
 Preview screen is displayed.




7. Press .

The setting is fixed.

The needle number has been changed from 3 to 5.



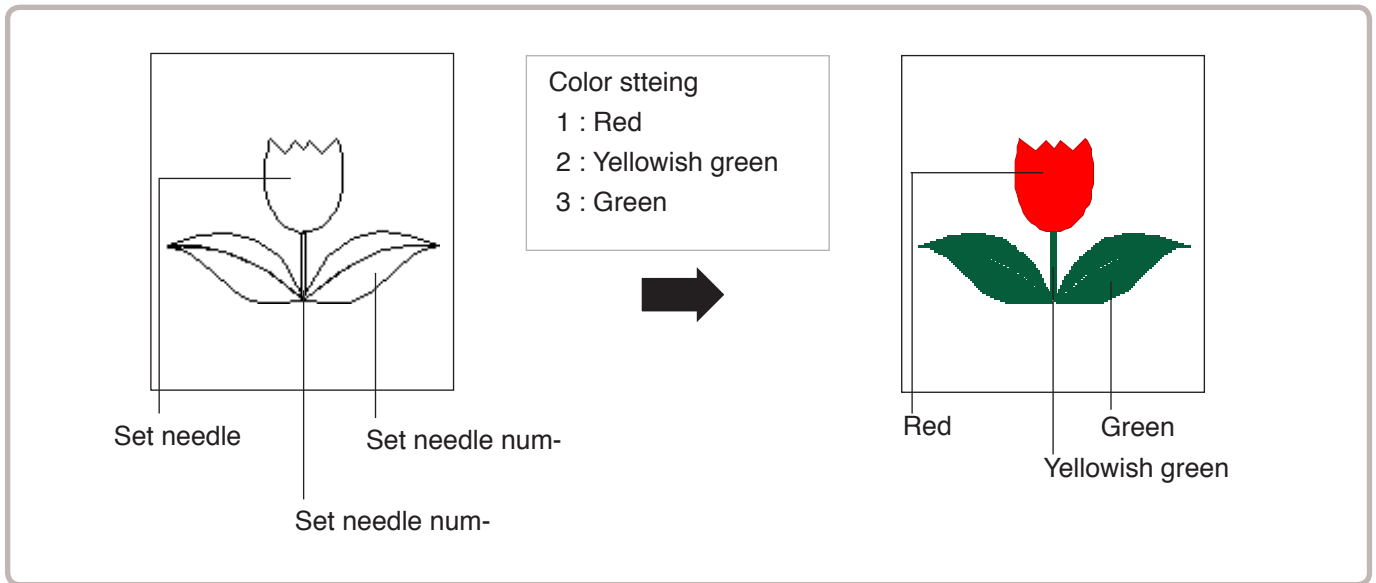
Press  to return to Menu mode.


Press  to return to Drive mode.

## ● Thread color

This sets the background color or color assigned to each needle bar to be shown in the display. This is useful to help confirm the correct color setup of a pattern. (128 colors are available)

■ You will find difficulty to see the pattern if you set same color on both pattern and background.



1. When the machine is stopped, press .



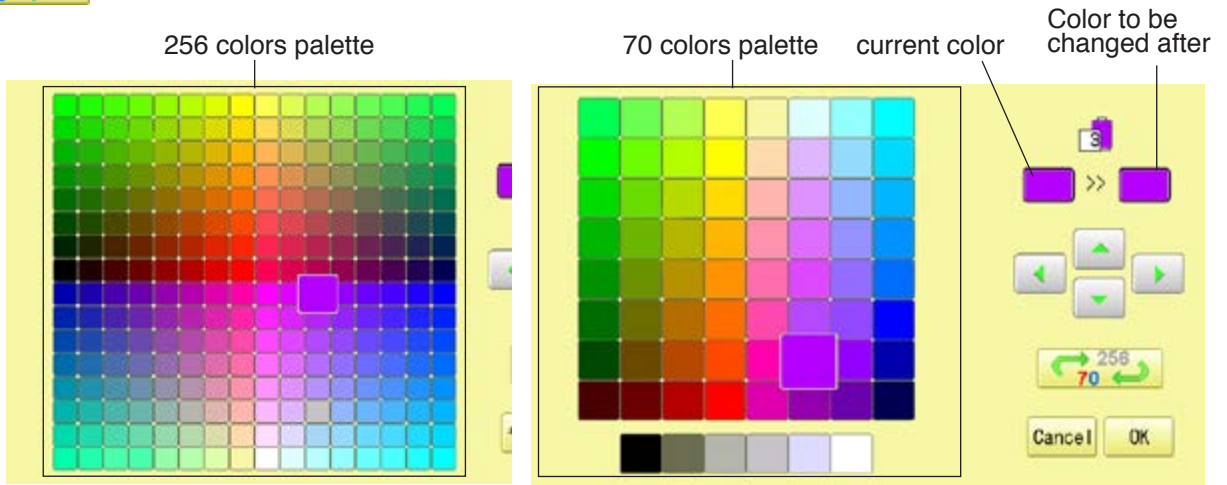
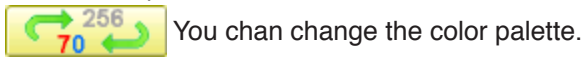
2. Select "NEEDLE".



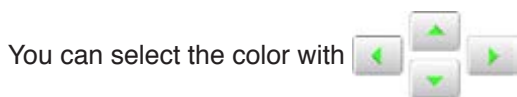
3. Press  from right submenu.



4. Select the needle number or cloth (background color).



5. Select the color to be changed at the palette.



Current color will be shown.

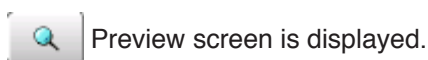


6. Press .



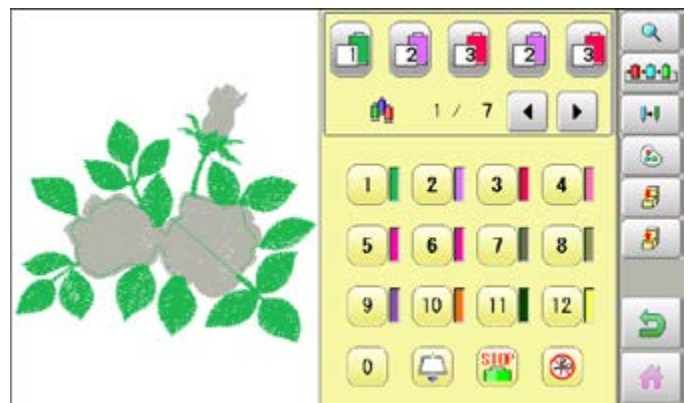
7. Press .

The setting is fixed.



Press to return to Menu mode.


Press to return to Drive mode.



## ●Color change data registration

You can import and apply color change data from saved patterns (Including color change stops) to the current pattern. This function lets you apply the same color change data from other patterns.

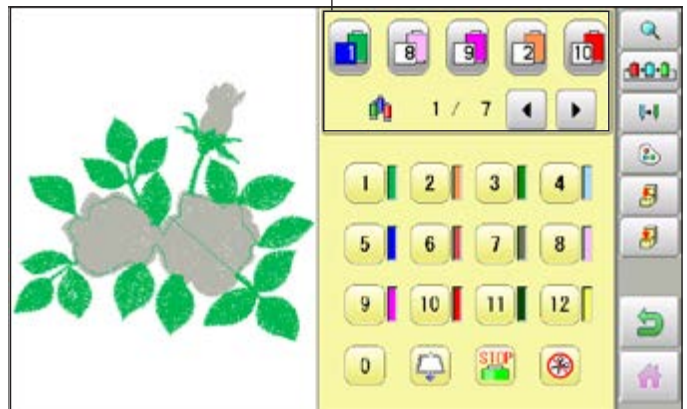
■ The color change data is limited to one and the color change numbers are limited to 250.

1. When the machine is stopped, press .

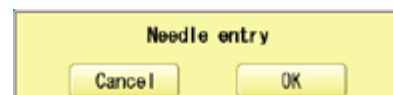


2. Select "NEEDLE".

Color change number

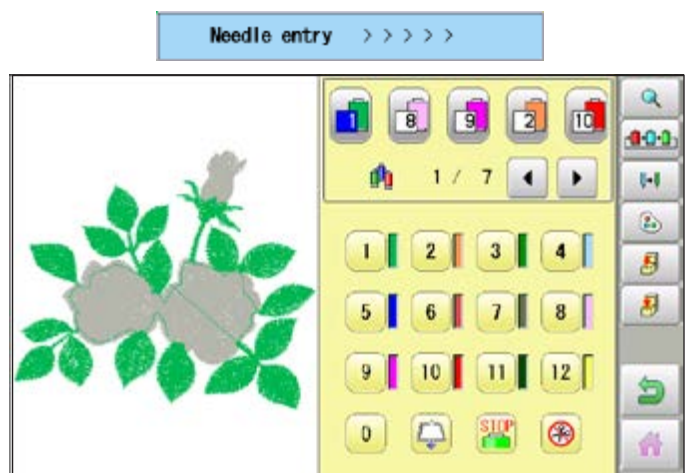


3. Press  from right submenu.



4. Press .

The color change data will be saved into memory.



Press  to return to Menu mode.


Press  to return to Drive mode.



## ● Color change data read

You can export the registered color change data to other patterns.

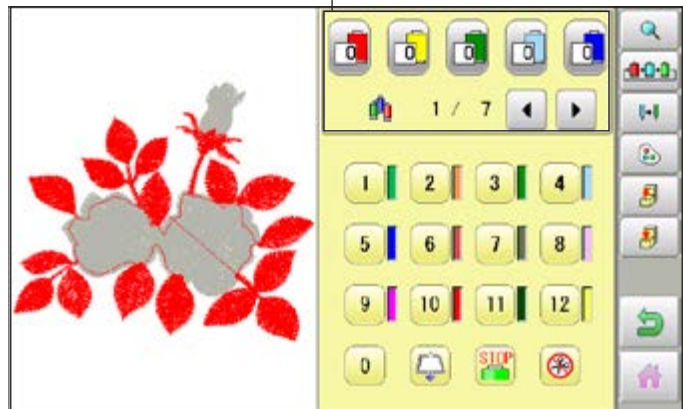
- If the pattern receiving the imported color change data has more color changes than the imported data, the extra color changes will be set to “0” and will need to be set manually later.

1. When the machine is stopped, press .

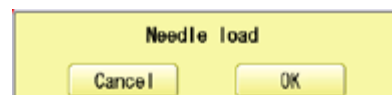


2. Select “NEEDLE”.

Color change number




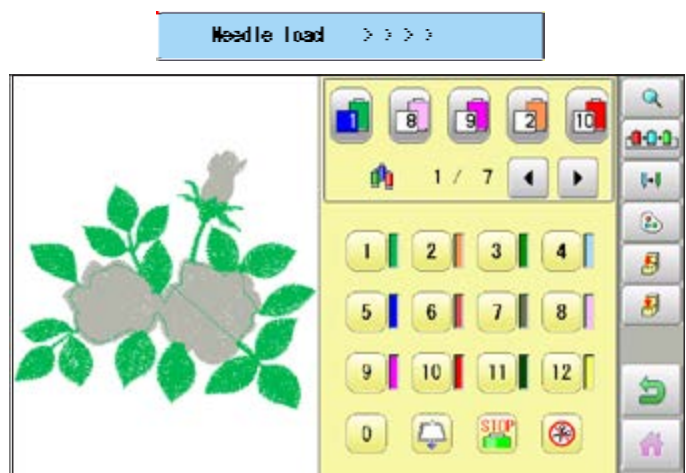
3. Press  from right submenu.



4. Press .

The needle number set is subject to the color change data exported.

Confirm the color shown in the  preview display.



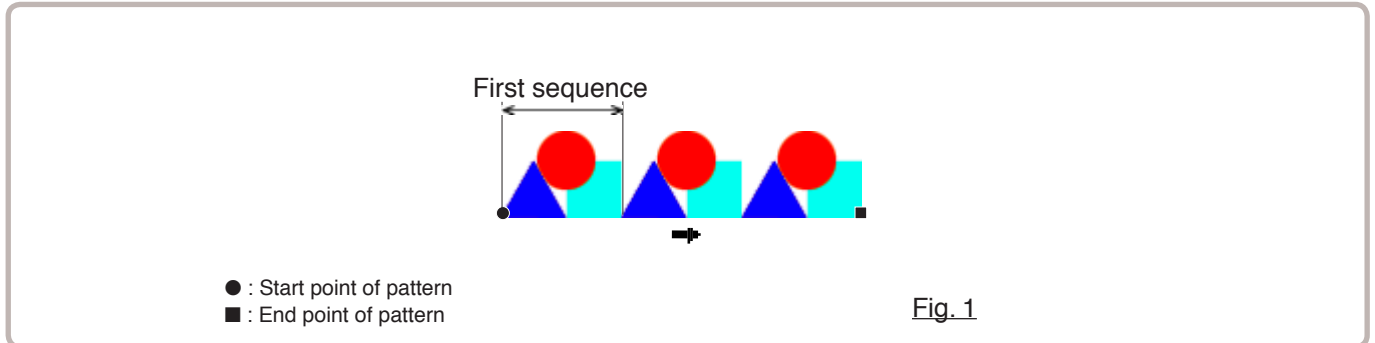
Press  to return to Menu mode.


Press  to return to Drive mode.

## ● Repetition of color group setting

If your design has repetition of the group of the same color sequence, only set first sequence and set other automatically by following steps.

(If you have some function in the needle “Example: color change stop”, the function also will set)



1. When the machine is stopped, press .



2. Select “NEEDLE”.



3. Set first color sequence group.

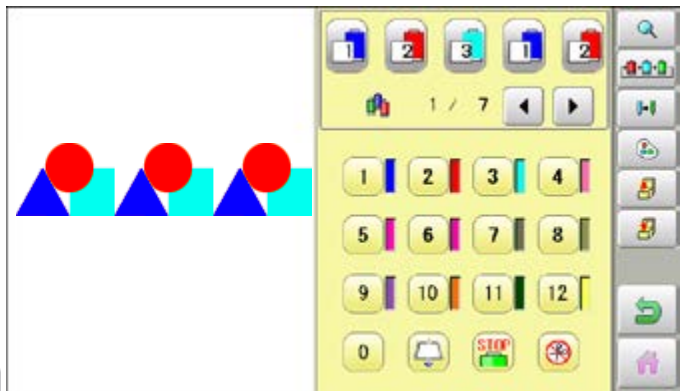
Please confirm that the next number of the group is “0”.



4. Press  from right submenu.

Set other color change setting automatically.

If the number of total color change does not become the first number of group multiple number. Machine display warning.



Press  to return to Menu mode.

Press  to return to Drive mode.

 Check repeat setting.

OK

By default the machine checks if the pattern fits the embroidery area.

This helps you to check whether or not the selected pattern fits in the desired hoop.

This helps confirm positioning between the embroidery area and the pattern.

If you change the frame position by the frame move key, the display will be changed and you can check the position onscreen.

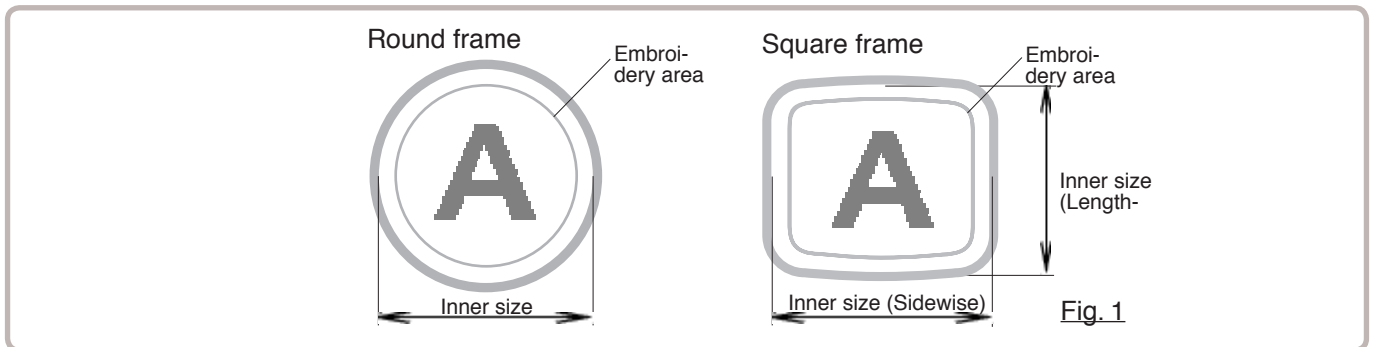
- ⚠ The "monitor display" checks whether or not the pattern fits the embroidery area of the frame you are going to use before starting the operation.  
This is not a safety device that will prevent crashes if pattern size is too large for the frame; it is intended for your reference only when judging the fit of a pattern to a given size frame. After using "monitor display", do not move the frame. If you do so the machine may be damaged due to the needle or pressure foot hitting the frame.
- ⚠ Make sure to perform "Registration number selection" when changing hoop size. If not done, the machine may be damaged from the needle or pressure foot hitting the frame.

## ● Frame selection

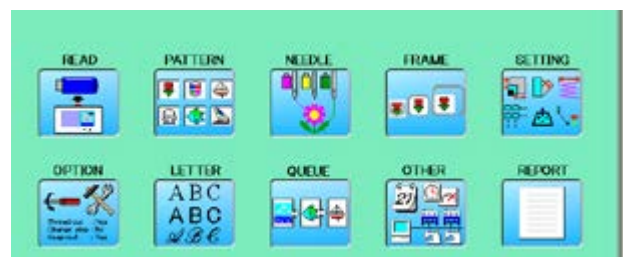
Selecting a frame.

The embroidery area for each registered frame is set to the inside of the frame edge to allow for pressure foot clearance. (Fig. 1)

This allows confirmation of positioning between the embroidery area and the pattern.



1. When the machine is stopped, press



2. Select "FRAME".

- : Tubular round frame
- : Tubular square frame, One touch frame
- : Cap and One-point frame
- : Square clamp frame
- : Sock frame
- : User-defined frame
- : Special frame
- : Non registered



3. Select type of frame.



Change the type of frame.



4. Select desired size of frame and press



The embroidery area appear in red.

5. Confirm that (Top) appears in the display and go to step 7.  
If this does not appear, go to step 6.

6. Press "Top".

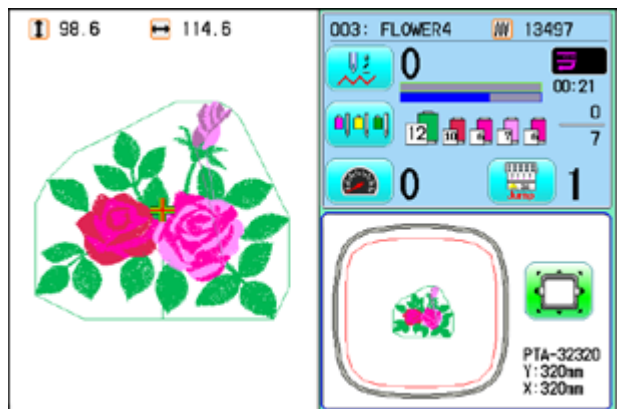
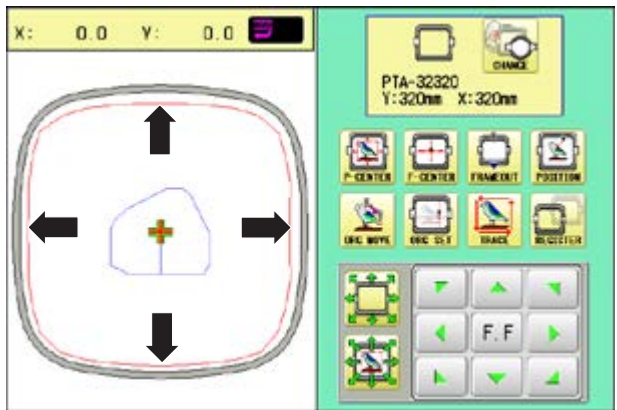
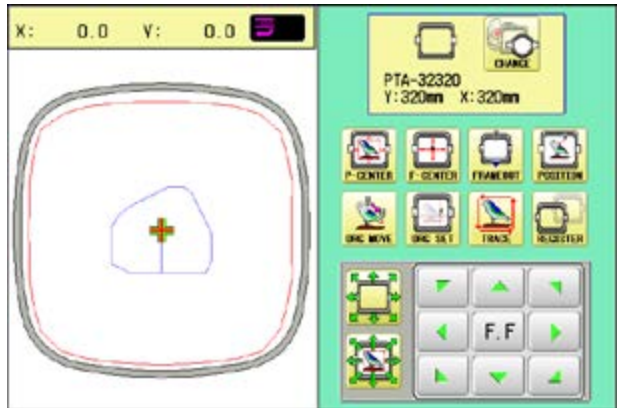
Upper right indication of will be shown.

7. By position of design can be moved.

8. Press .

The display returns to Drive mode.

Start sewing by pressing .



## ● Adjusted for embroidery area

### Cap frame

The embroidery area of HAPPY semi-wide and wide cap frames is saved in the machine. The Y axis of the embroidery area can be adjusted for a variety of caps. (Fig. 1)

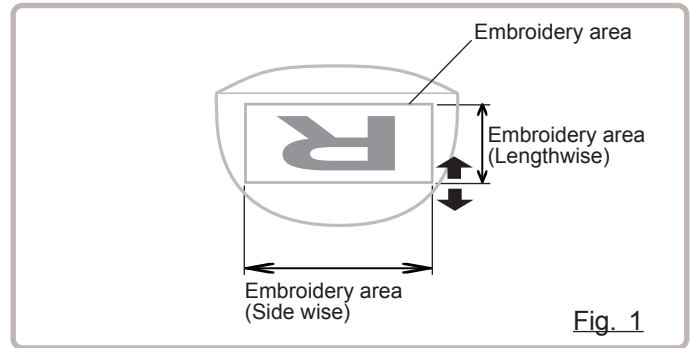



Fig. 1

1. When the machine is stopped, press 



2. Select "FRAME".



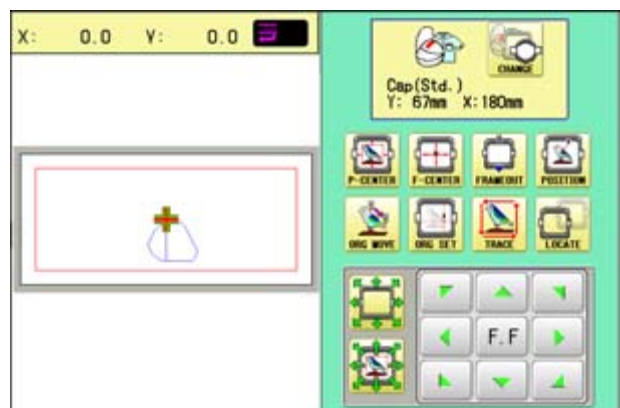
3. Select  "Cap and One-point frame".



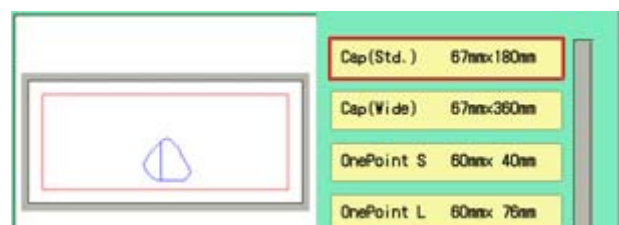
4. Select desired size of frame and press



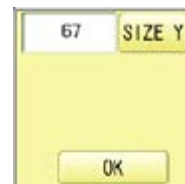
The embroidery area and outline of the pattern itself appear in red. All are displayed on the left together.



5. Press 



6. Press .



7. Press .



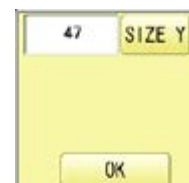
8. Select the number .

Enter the width of the cap.

Standard 40 ~ 67mm  
Width 40 ~ 95mm

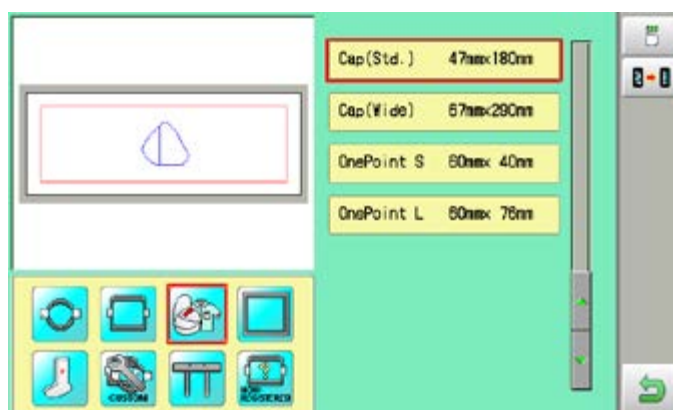


9. Press .



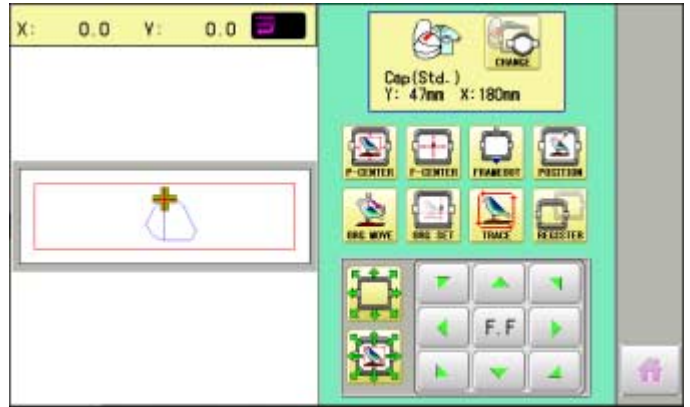
10. Press .

The setting is fixed.



Settings are returned to the default.

11. Press



Press



to return to Drive mode.

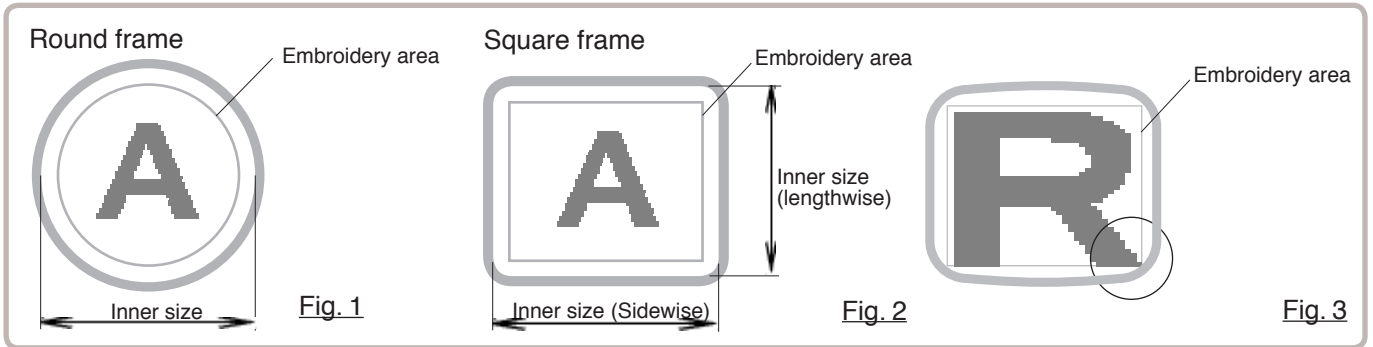


## User-defined frames (1 ~ 5)

The embroidery area of each registered frame is set to the inside of the frame edge for pressure foot clearance. (Fig. 1, 2)

■ The embroidery area of each registered frame is set to the inside of the frame edge for pressure foot clearance. (Fig. 1, 2)

When you use square frame as shown in fig.3, pressure foot may hit the corner of frame. In this case you need to create frame as special shape under the frame No.6 - 20.



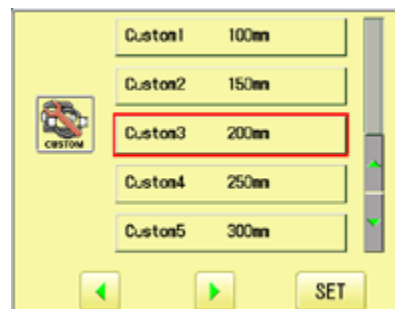
1. When the machine is stopped, press



2. Select "FRAME".



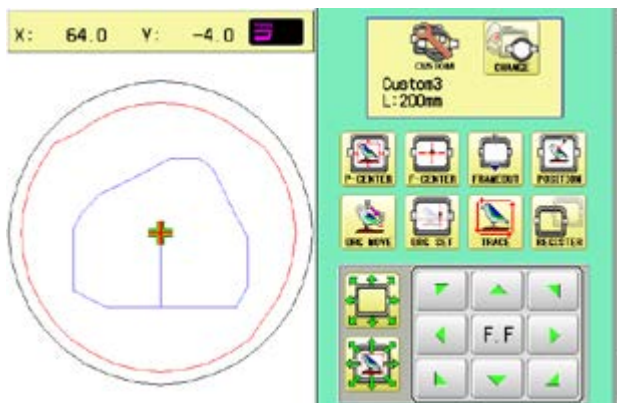
3. Select "User-defined frames".



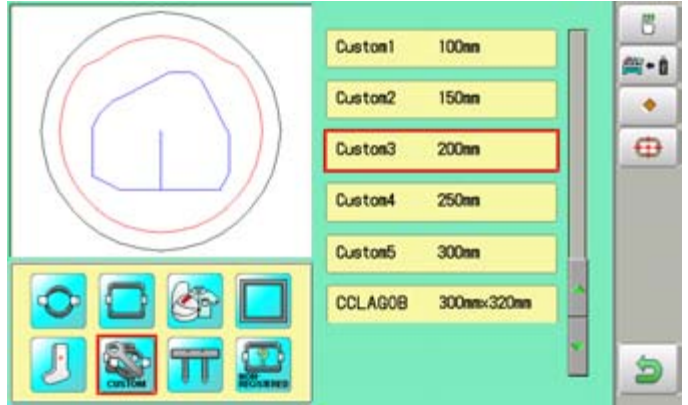
4. Select desired size of frame and press



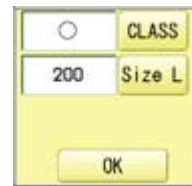
The embroidery area appear in red.



5. Press .



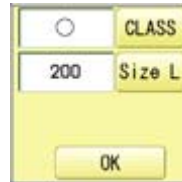
6. Press .



7. Press **CLASS** to select the hoop (Class).

- : Round frame
- : Square frame

Case for selected round frame



Case for selected square frame



8. Press **Size L**.

Select **SIZE Y** or **SIZE X** you wish to change square frame size.

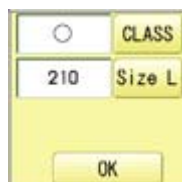


9. Select the number .

Input number for size of embroidery area.



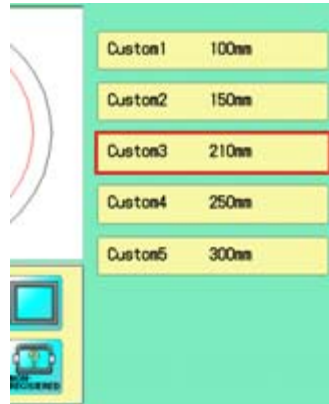
10. Press **SET**.



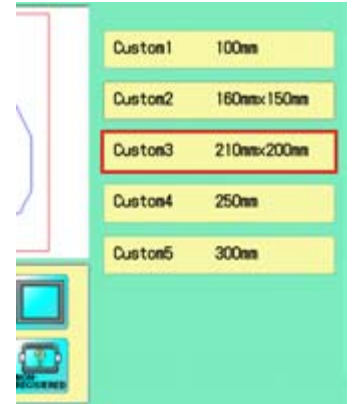
11. Press  .

The date is fixed.

Case for selected round frame




Case for selected square frame



12. Press  .




Press  to return to Drive mode.

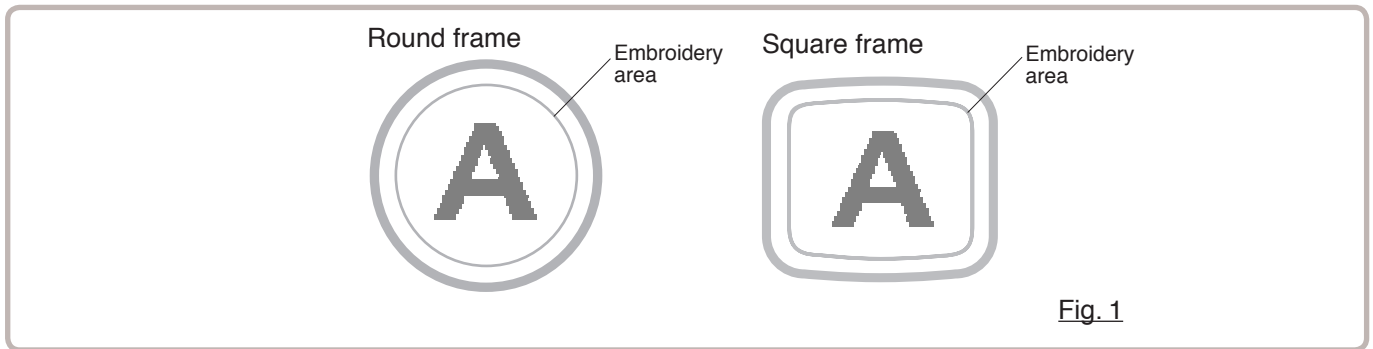
## ● User-defined frames (6 ~ 60)

You need to prepare for the data which entered the shape of the frame and entry the entered data.

You can entry the data up to 55 different size of custom frames.

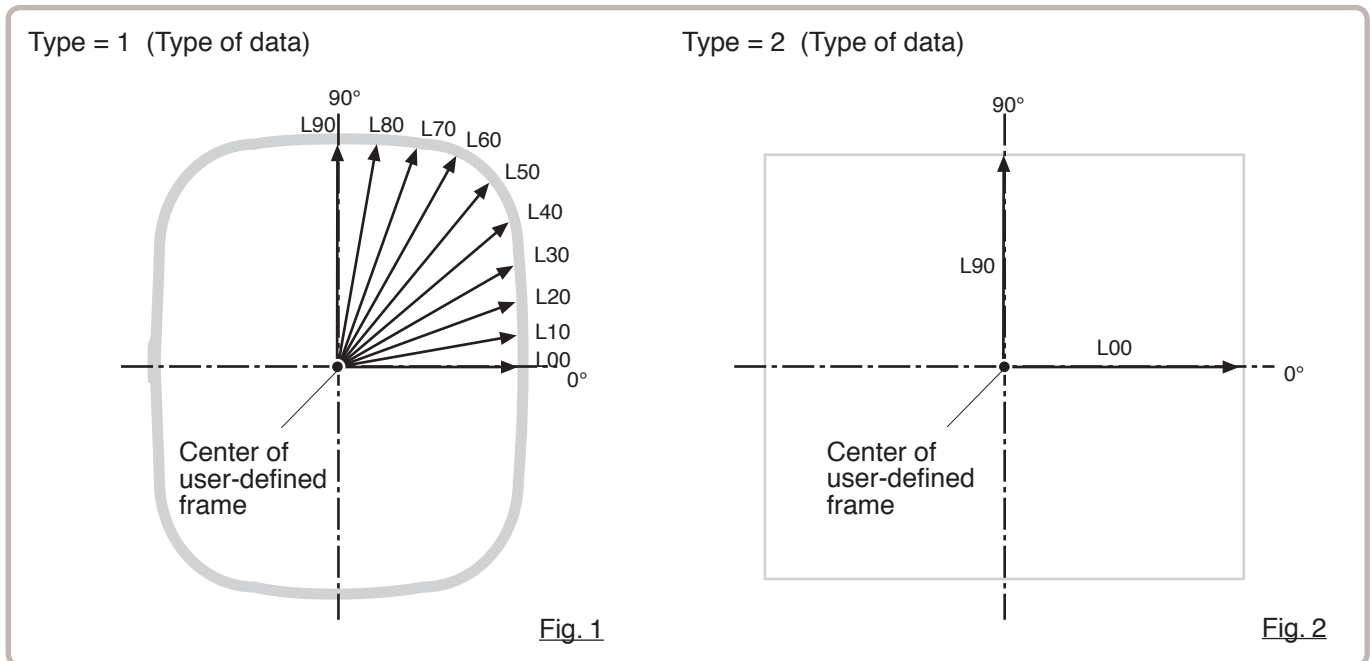
You need to prepare custom frame size data for entry the size to your machine.  13-B

The embroidery area for each registered frame is set to the inside of the frame edge to allow for pressure foot clearance. (Fig. 1)



## How to make frame size data of your User-defined frames (6 ~ 60)

We need to use text edit software of PC like “WordPad” and make frame size data with following constitution, then entry the data to your machine.



### Frame data constitution

Type = [Type of data]

Name = “[Name of frame]”

Form = [L00],[L10],[L20],[L30],[L40],[L50],[L60],[L70],[L80],[L90] (Frame shape)

Type : Select type of data by following number.

1 : Frame size    2 : Possible embroidery size

Note: If select “1”, machine will memory reduced size for Presser foot diameter automatically.

If select “2”, machine will memory exactly same size as can embroider it on.

Name : Naming the your User-custom frame. Pick up to 10 letters up with a “mark.”

Form : Refer the above figure. Please fill it out every 10 degrees of dimensions to the inside of the frame in a frame heartily. (20 to 500mm)

Fill it out length from point from No. L00 till L90 total 10 points size using “,” between the each size data.

If your frame shape is Round, the every 10 points length frame size data should be same.

If you select Type (Type of data) “2”, please put length data of L00 and L90 only.

END : Please fill out the line of the last of data. Please make entry of “END” by all means.

Please use half width character for the length data.


Please cut off the decimal of the length.

Example: 102.3mm -> 102

When you save the frame size data, please save as text document form and file name should be less than 8 characters.

Extension should be ".TXT"

Example: ROUND250.TXT

Please save the frame size data to machine usable memory media and read the data by embroidery machine.  13-D

## Example of making the frame size data

Sample for each teaching method.

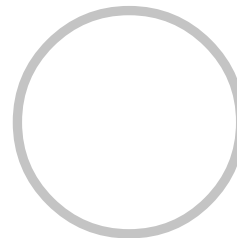
Ex. Round frame

Type = 1

Name = "Round"

Form = 125,125,125,125,125,125,125,125,125,125

END



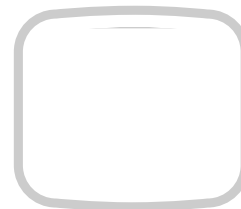
Ex. Square frame

Type = 1

Name = "PS240"

Form = 120,122,126,130,128,120,106,100,96,94

END



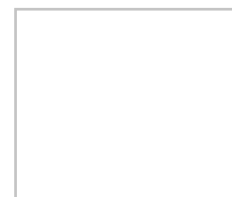
Ex. Possible embroidery size

Type = 2

Name = "T-SC-01"

Form = 90,60


END



# FRAME CONFIRMATION

# 13-D

## Reading frame data

1. When the machine is stopped, press .



2. Select "FRAME".

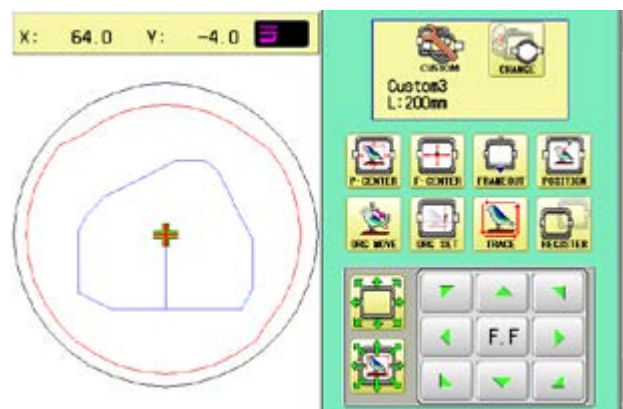


3. Select  "User-defined frames".

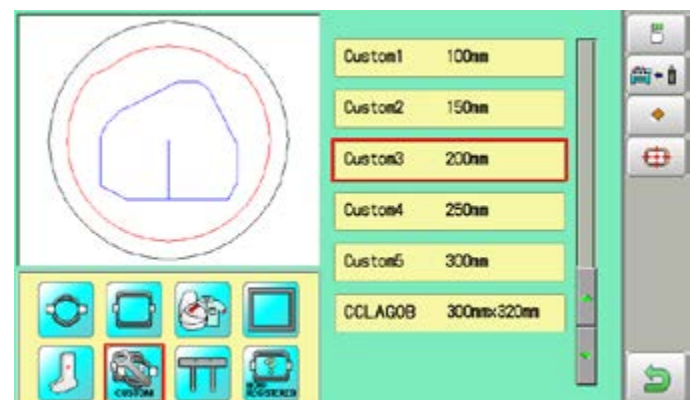


4. Press .

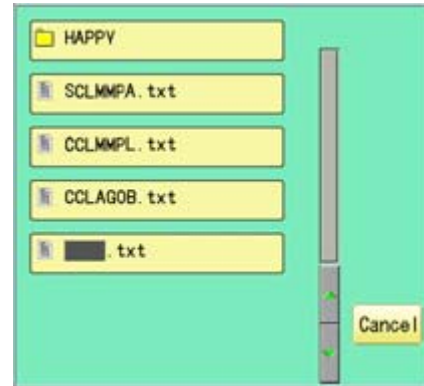
You can choose any frame options.



5. Press .

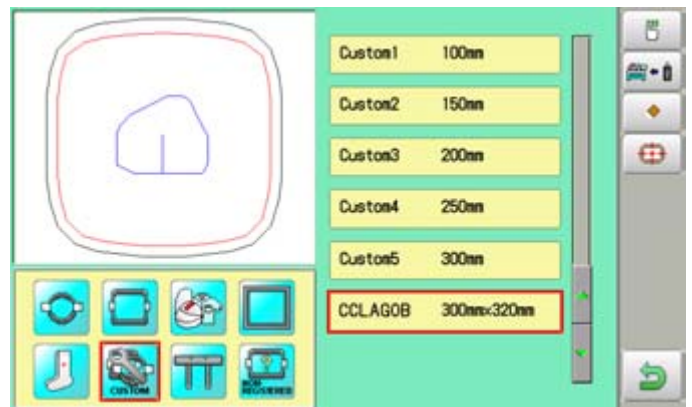


6. Press .




7. Select the frame data "CCLAGOB.txt".

The frame data has been read.



8. Press .




Press  to return to Drive mode.



## How to delete the resisted user-defined frames (6 ~ 60)


Delete resisted User-defined frame from memory.

1. When the machine is stopped, press  .



2. Select "FRAME".

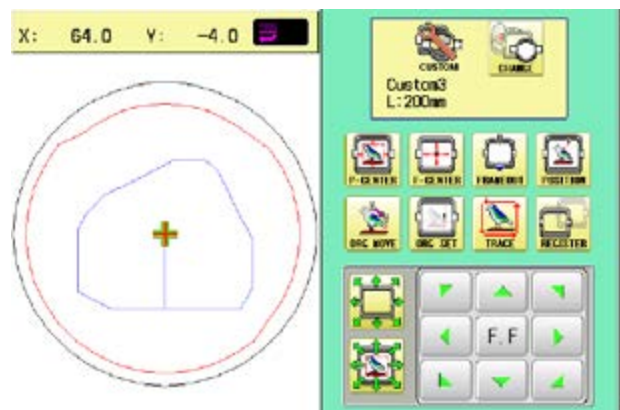


3. Select  "User-defined frames".

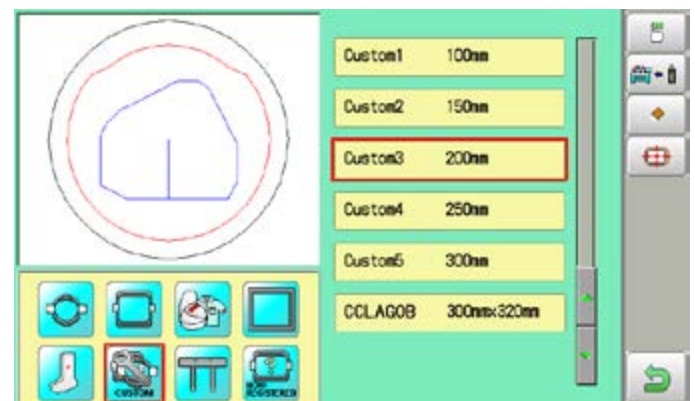


4. Press  .

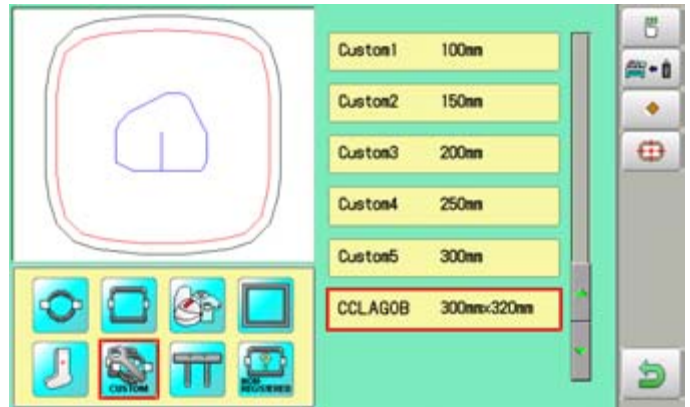
You can choose any frame options.



5. Press  .

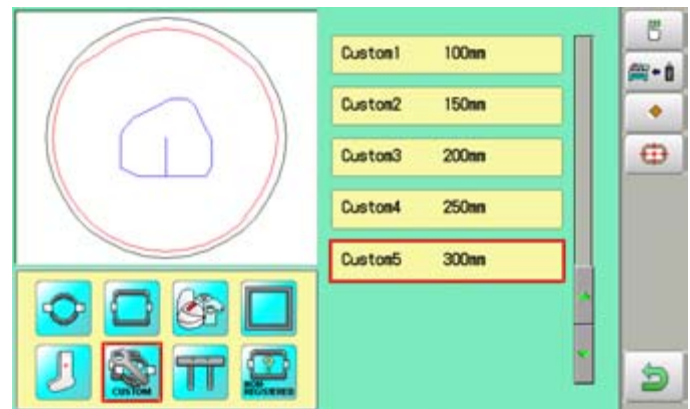


6. Select desired User-defined frames.



7. Press .

The user-defined frames will be deleted.



8. Press .




Press  to return to Drive mode.

## ● How to change center point of frame (1 ~ 5, 6 ~ 60)

You can change memorized frame center point.

When you set your frame and use machine function of “Frame move” and “Center” (P 3-6), If your frame is not center, please practice following steps for center setting again.

1. When the machine is stopped, press .



2. Select “FRAME”.

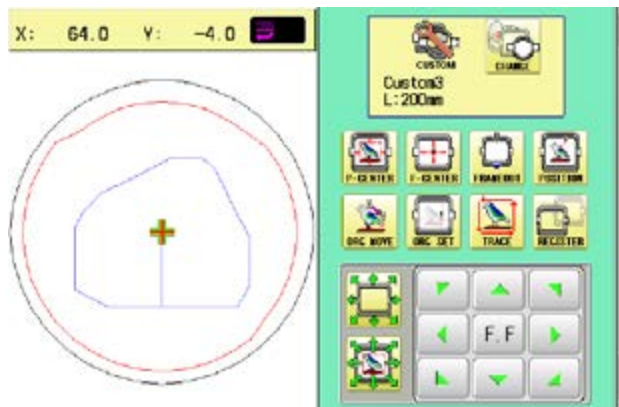


3. Select  “User-defined frames”.

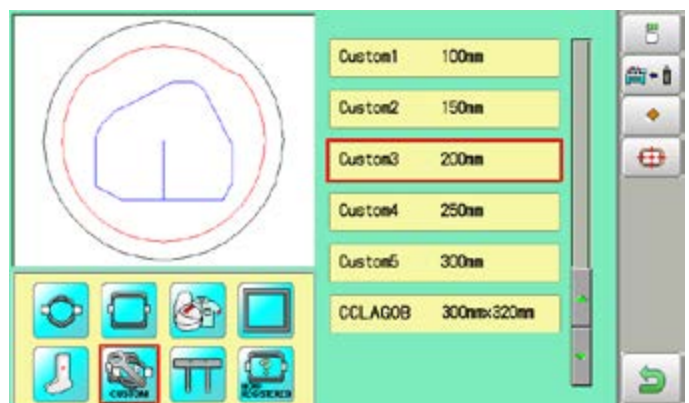


4. Press .

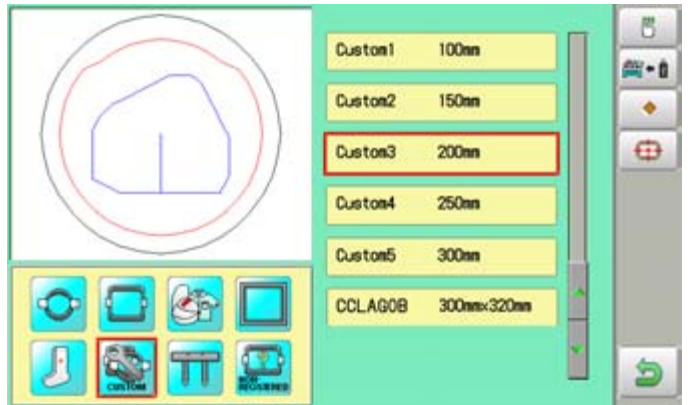
You can choose any frame options.



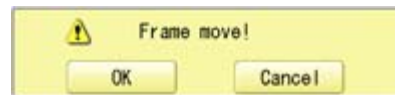
5. Press t .





6. Select desired User-defined frames.

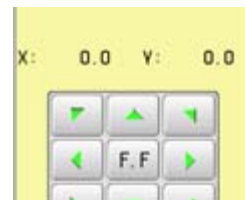


7. Press .

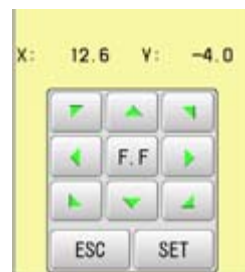


8. Press .

 **CAUTION: To prevent accidents.**  
The frame moves quickly.  
Keep hands away from the frame.

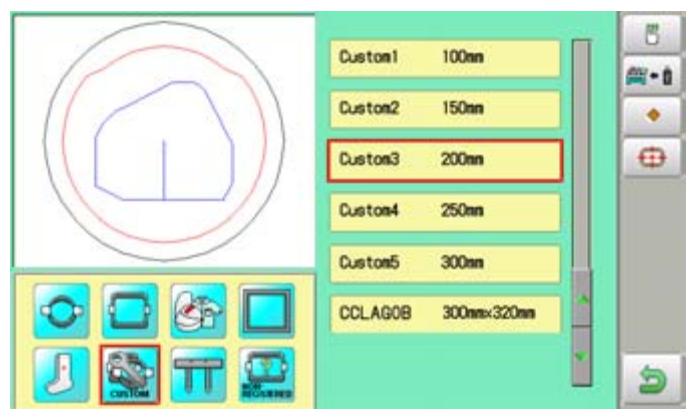


9. Move embroidery frame to frame center




10. Press .

Memorized frame center point coordinate to the machine.



11. Press .



Press  to return to Drive mode.

## ● Non registered, Special frame ( Except HCR2)

In case Non Registered Frame is selected, carriage does not have movement for creating the coordinates of frame position at the time of turning machine on.  
Please select Non Registered Frame, when you need use special frame which can hit pressure foot or other machine parts by movement of carriage for creating the coordinates of frame position.

The following functions is canceled by selecting Non Registered Frame;

- \* Frame confirmation
- \* Restore the position at the time of power failure
- \* Locate
- \* Autostop function when movement exceeds the carriage limit.



Except using special shape frame, please do not select Non Registered Frame.



In case you have operation mistake, needle and/or pressure foot may hit frame and machine and/or frame can be damaged.

1. When the machine is stopped, press



2. Select "FRAME".



3. Select  "Non registered" or  "Special frame".

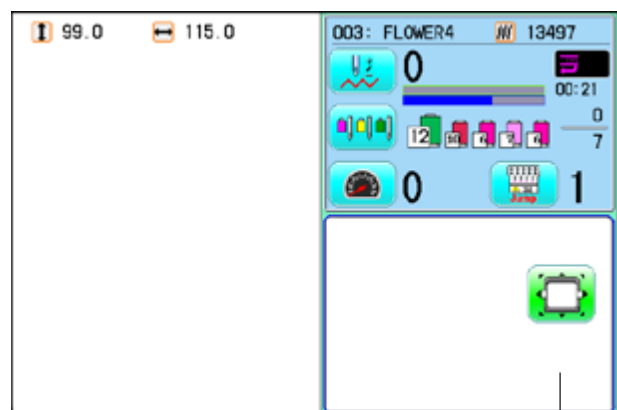


4. Press



Indication of frame type disappears.  
It means that "Non Registered (Special frame)" is selected.

- When you need to change from Non Registered frame (Special frame) to other type of frame, please power machine off and start again.  
Without re-starting machine, machine will move incorrectly.



Frame indication disappears

Various settings such as the scaling, repeat sewing, offset and frame out can be applied to a pattern.

## **Adjust**

This menu contains settings such as scaling, width adjustment, angle and convert design.

## **Repeat sewing**

The machine repeats the pattern a number of times in the X and Y directions as set by the user.

## **Offset**

Sets the start point of the frame in the selected pattern.

## **Frame out**

Inserts a frame out command in the selected pattern.

■ Various settings are executed in assortment.

## ● **Adjust**

### **Scaling**

This adjusts the scale of the selected pattern.

### **Width adjustment**

This adjusts the width of the selected pattern.

### **Angle**

This adjusts the angle of the selected pattern.

### **Convert design** **9-5**

This sets the rotation of the selected pattern in increments of 90 degrees, normal or reversed.

## Scaling

The pattern's scale can be increased or decreased in 1% increments.

### Setting example

R


Normal

Default : X,Y 100%

R

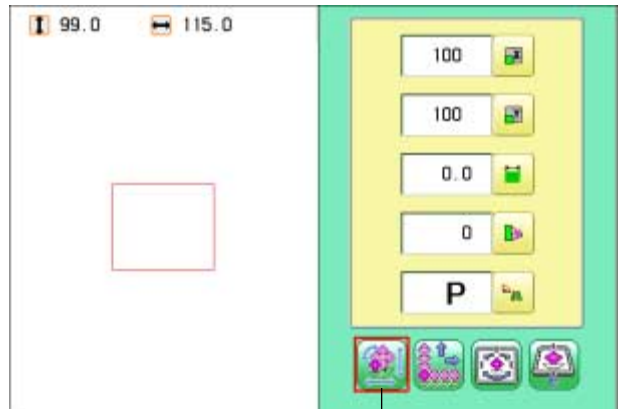
X 100 %, Y 150 %

● : Start point of pattern



1. When the machine is stopped, press .



2. Select "SETTING".



Adjust


3. Select  (Scaling X) or  (Scaling Y).




4. Select the number.



 Changing is cancelled.


 Numbers are deleted.

5. Press .


The setting is fixed.

148.0 115.0



 The pattern data may be shown.

 Setting is returned to the default.

 To return to Menu mode.

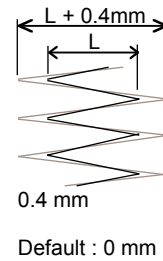
 to return to Drive mode.


## Width adjustment

This setting adjusts stitch width (L) in a pattern in a range of -1.0 ~ +1.0mm in increments of 0.1mm.

■ In case "Width" (Width adjustment) is set and embroidery is made, there is a case that error occurs at end point. In such a case, please return setting figure of stitch width to "0.0".

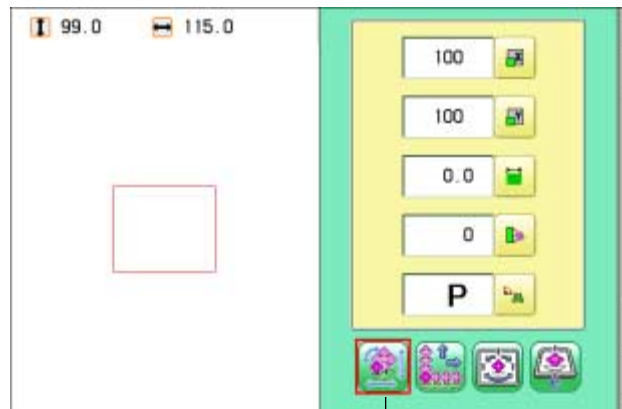
### Setting example



1. When the machine is stopped, press .





2. Select "SETTING".




3. Select  (Width adjustment).



4. Select the number.





-  Changing is cancelled.
-  Numbers are deleted.



5. Press .

The setting is fixed.



-  The pattern data may be shown.
-  Setting is returned to the default.
-  To return to Menu mode.
-  to return to Drive mode.



## Angle

With the start point of the pattern as a pivot, the machine rotates the angle clockwise.

### Setting example




Normal

Default : 0°



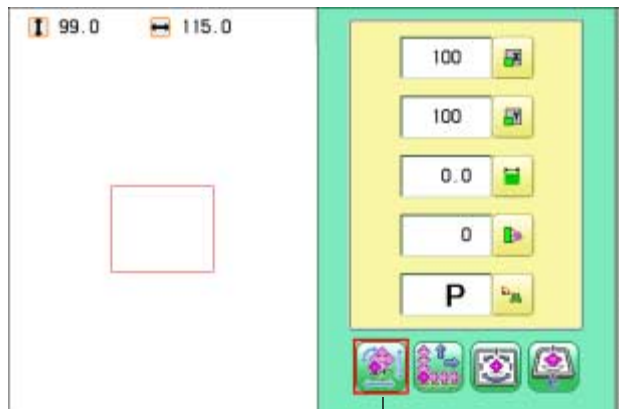
30°


● : Start point of pattern

1. When the machine is stopped, press .



2. Select "SETTING".



3. Select  (Angle).

Adjust



4. Select the number.



 Changing is cancelled.





 Numbers are deleted.

5. Press .

The setting is fixed.

110.0 120.0

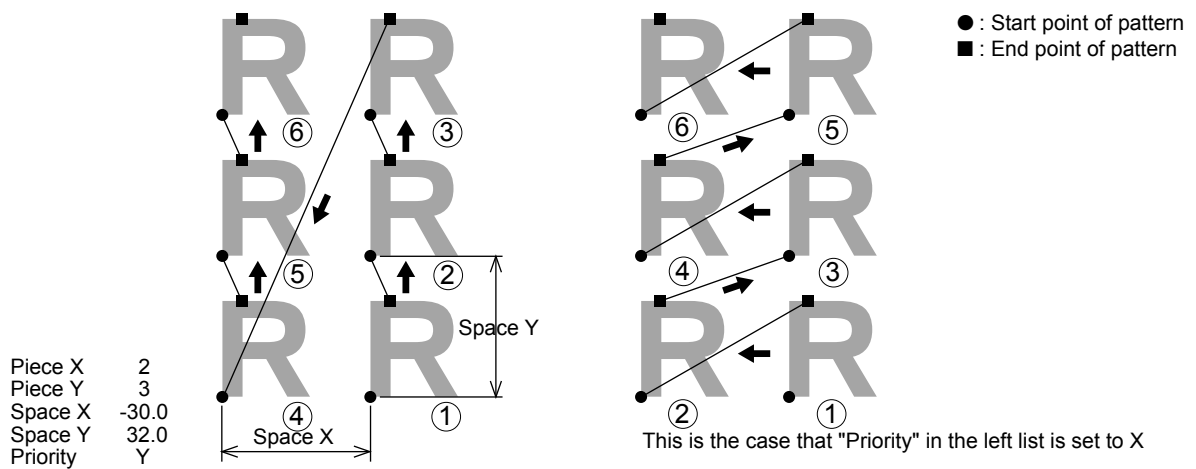


-  The pattern data may be shown.
-  Setting is returned to the default.
-  To return to Menu mode.
-  to return to Drive mode.


## ● Repeat sewing

The machine embroiders a user-specified number of copies in the X and Y directions.


### Setting example











SETTING ITEM	SETTING RANGE	DEFAULT	
Piece X	1 ~ 30	1	This sets number of pieces side wise and length wise when you perform repeat.
Piece Y	1 ~ 30	1	The number of pieces to be embroidered is product obtained by multiplying numbers in X and Y.
Space X	-999.9 ~ 999.9 mm	0	This sets side wise distance between start point of each pattern when you perform repeat. When plus number is input, the machine makes repeat toward right. In case of minus number, toward left.
Space Y	-999.9 ~ 999.9 mm	0	This sets length wise distance between start point of each pattern when you perform repeat. When plus number is input, the machine makes repeat upward. In case of minus number, downward.
Priority	X (Side)• Y (Length)	X	When you set more than 2 pieces for repeat length wise and side wise, this selects direction to embroider 2nd piece.

1. When the machine is stopped, press .



2. Select "SETTING" and select  (Repeat).



-  Gap  14-6a
-  No gap  14-6a
-  Fill  14-6a

 60.4  50.4




Repeat

3. Select each setting item and select the number.



-  Changing is cancelled.
-  Numbers are deleted.



4. Press .

The setting is fixed.

Overall size      Pattern size

 220.4  140.4  
(60.4)      (60.4)

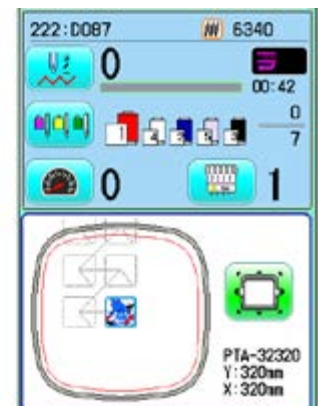





5. Set necessary item by performing procedure no. 3 to no.4.

Set all the necessary items.

6. Press .

 220.4  140.4




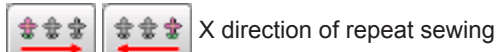
-  The pattern data may be shown.
-  Setting is returned to the default.
-  To return to Menu mode.


## Gap

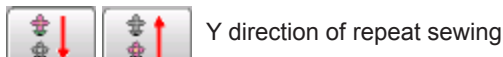
Set the space X and space Y (pattern size + gaps) set in the setting items with only gaps, and relocation.

1. Press .

2. Enter X gaps and press .



3. Enter Y gaps and press .



It will be relocated with the set gap.

You can change each setting item even after relocation.

 241.2 (60.4)  150.8 (60.4)



Setting item



## No gap

The number of X and Y numbers set in the setting items will be relocated without gaps.

1. Press .

It will be relocated without gaps.

You can change each setting item even after relocation.

 181.2 (60.4)  120.8 (60.4)



Setting item




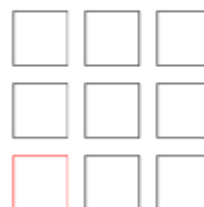
## Fill

Relocate the maximum number at the set space to the selected frame.

1. Press .

It will be relocated.

 220.4 (60.4)  220.4 (60.4)



Setting item

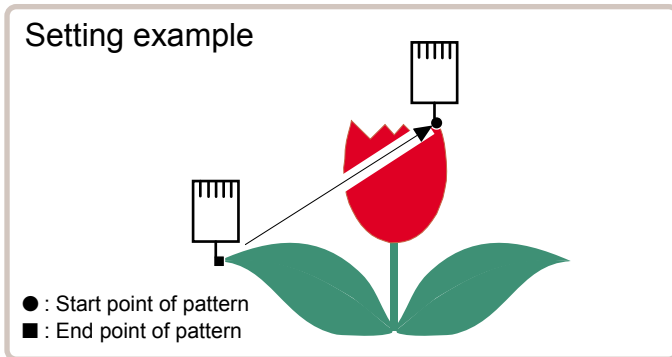



## CAUTION

The machine calculates the shape of the selected frame as a simple rectangle (square). Check if it is actually inside the frame, and set the number and space in the setting items as necessary.


## ● Auto origin

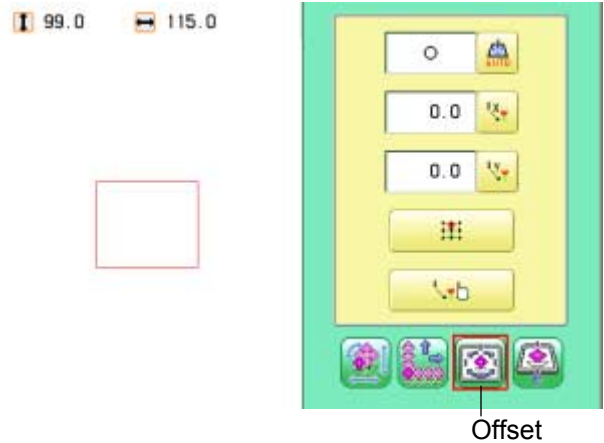
When a pattern has different start and end points, the frame returns to the start point.




1. When the machine is stopped, press .







2. Select "SETTING" and select  (Offset).



3. Press  (Auto origin) and select  (ON) or  (OFF).

The setting is fixed.



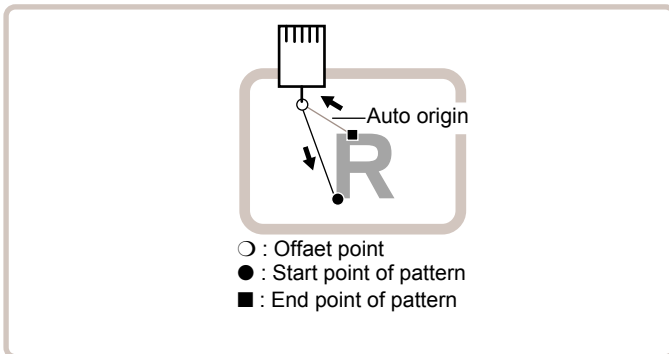
-  The pattern data may be shown.
-  Setting is returned to the default.
-  To return to Menu mode.
-  to return to Drive mode.

## ● Offset

Setting the offset point designates a place for the frame to rest before moving to the start point of the actual embroidery.

When used together with the "Auto origin" (P 14-7) feature, the machine will return to the offset when it is finished embroidering as well.

This allows you to send the frame to a place where it will be easier to handle, when you will need to change hoops for example.



## Direct input


You can move the offset point manually and save the position with "Teaching input".

## Preset

There are 9 preset points that can be used for offsets around and in the center of the pattern.

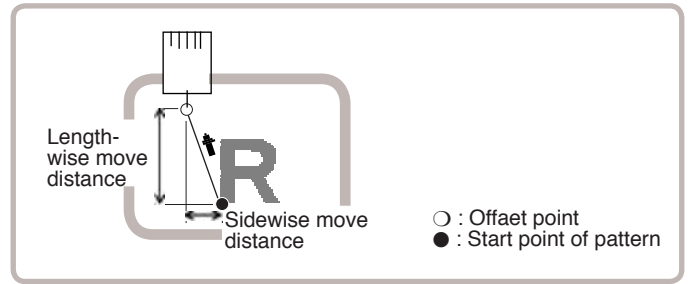
## Teaching input


You can set the offset point manually.

- When you Press  (Original point return) or use "Auto origin" (P 14-7) with an offset, the frame will return to the offset point.


## Direct input

You can move the offset manually and save the position with “teaching input”.







1. When the machine is stopped, press .



2. Select “SETTING” and select  (Offset).



3. Select  (X axis distance) or  (Y axis distance) and select the number.

-  Changing is cancelled.
-  Numbers are deleted.

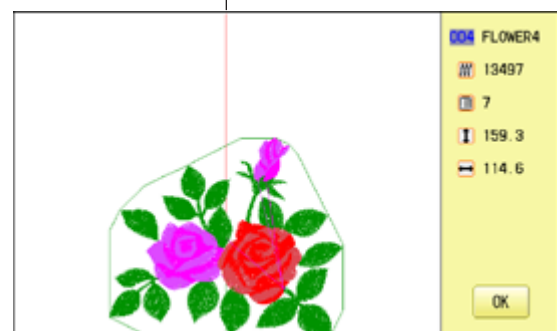






4. Press .

The setting is fixed.




Offset point




-  The pattern data may be shown.
-  Setting is returned to the default.
-  To return to Menu mode.
-  to return to Drive mode.

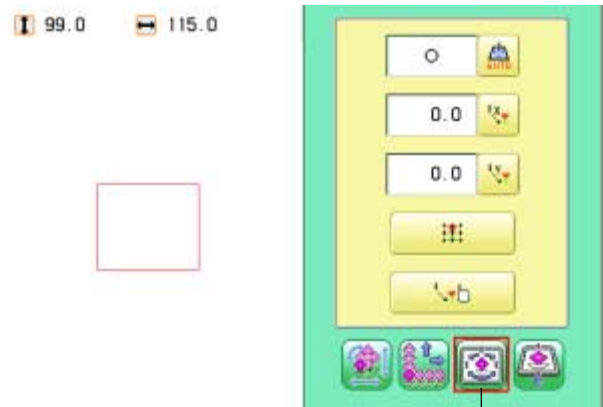
## Preset

There are 9 preset points that can be used for offsets around the or in the center of the pattern.

1. When the machine is stopped, press .




2. Select "SETTING" and select  (Offset).



Offset

3. Select .



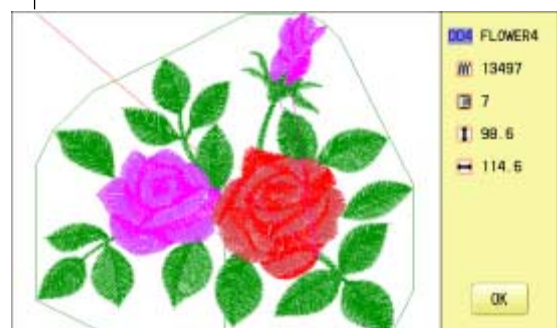
4. Select the offset point and press .





The setting is fixed.

 Setting is unset.



Offset point

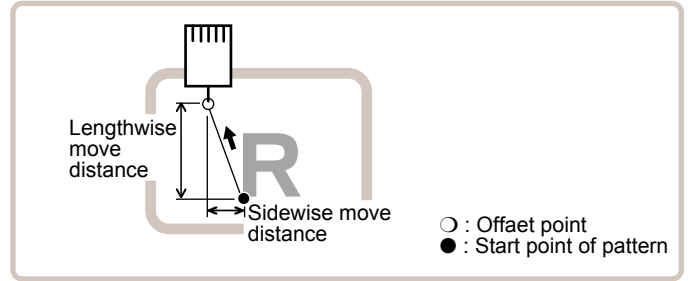



-  The pattern data may be shown.
-  Setting is returned to the default.
-  To return to Menu mode.
-  to return to Drive mode.




## Teaching input

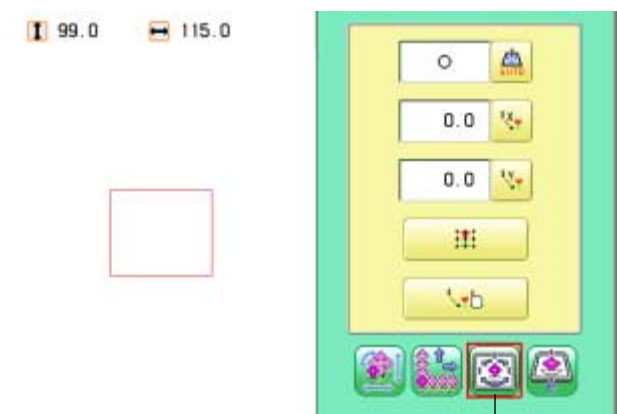
You can set the offset position manually.



1. When the machine is stopped, press .

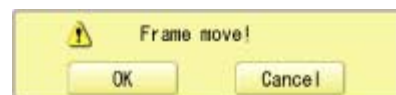


2. Select "SETTING" and select  (Offset).



Offset

3. Select .




4. Press .



**CAUTION: To prevent accidents.**  
The frame moves quickly.  
Keep hands away from the frame.

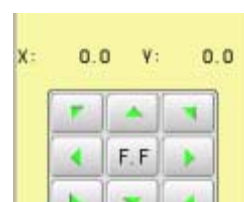
5. Move the frame to the pattern start point.

 Setting is cancelled.

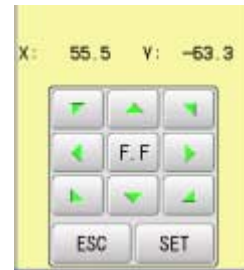


6. Press .

The setting is fixed.







7. Move the frame to the offset point.



8. Press **SET**.

The setting is fixed.



-  The pattern data may be shown.
-  Setting is returned to the default.
-  To return to Menu mode.
-  to return to Drive mode.



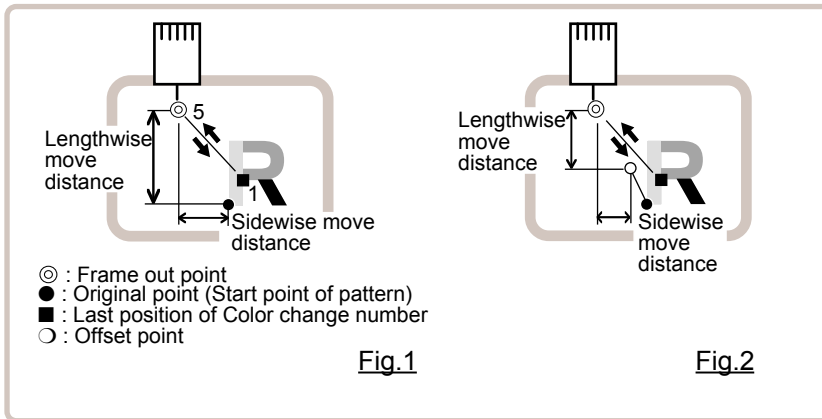
Offset point

## ● Frame out

A frame out command can be added to a design. By setting frameout to a \*Color change number in a design, you can move the frame to a desired position automatically and stop it after the machine finishes sewing of that color change number.

When you resume operation, the frame has an automatic return to previous position and you can continue sewing. (Fig.1)

This function will be convenient for trimming threads while embroidering or for sewing applique etc.



## Selection of color change number 5-F

Set Color change number to execute frameout.

## Teaching input

Set position of frame out and the distance of movement will be the frame out distance.

Usually move distance to frame out point is input, with original point as pivot.(Fig.1)

In case offset is set, the move distance is input with offset point as pivot.(Fig.2)

- You can set number of stitches or Color change number to make frame out in plural, but frame out point is limited to one place. The point set finally becomes good for making frame out. The point set finally becomes good for making frame out.

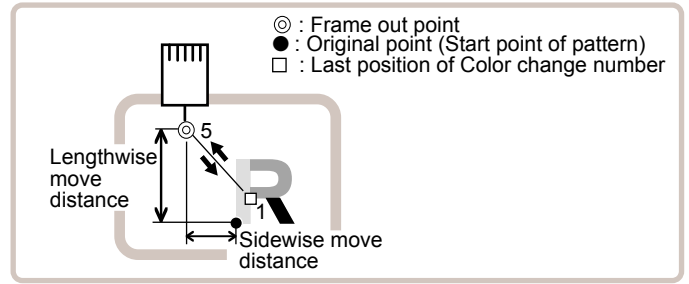
## Direct input

You can set the position of frame out directly by inputting by the number keys. You can also change the position of a frame out set by "Teaching input".

Normally, the distance to the frameout point is input with the original point as a pivot. (Fig. 1) In case where an offset is set, the move distance to frameout position is input with offset point as pivot. (Fig.2)

## Teaching input

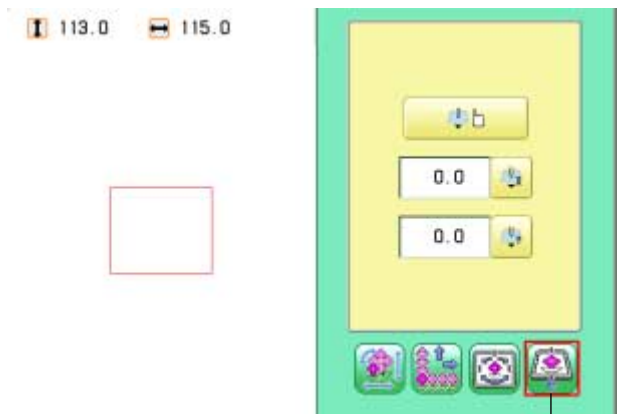
Move the frame and the position will be saved as the frame out.



1. When the machine is stopped, press

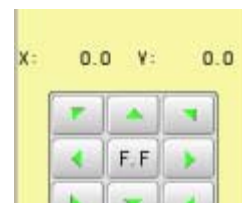


2. Select "SETTING" and select (Frame out).



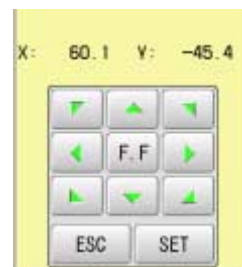
Frame out

3. Select



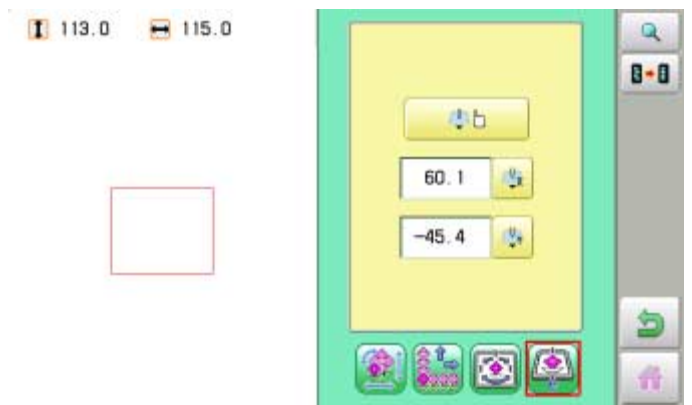
4. Move the frame to the frame out position.

Setting is cancelled.



5. Press

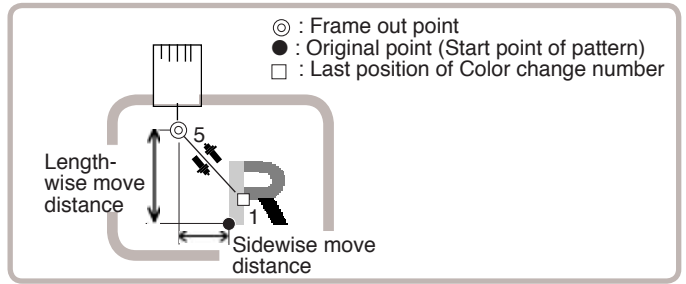
The setting is fixed.




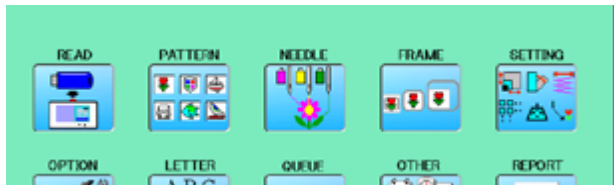
- The pattern data may be shown.
- Setting is returned to the default.
- To return to Menu mode.
- to return to Drive mode.


## Direct input

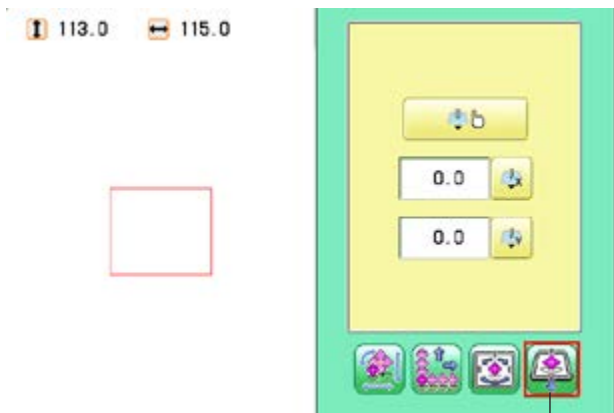
You can change the position of your frame out by using this function. You can change the moving distance of the frame out and change the frame out position, which saved by “Teaching input”.





1. When the machine is stopped, press .





2. Select “SETTING” and select  (Frame out).



Frame out

3. Select  (X axis distance) or  (Y axis distance) and select the number.





-  Changing is cancelled.
-  Numbers are deleted.



4. Press .




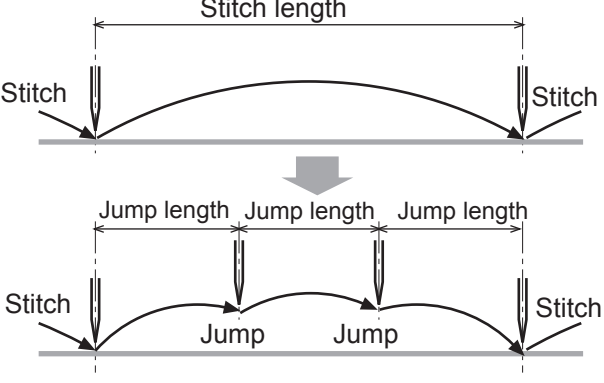

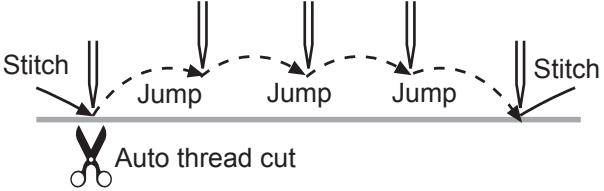
The setting is fixed.

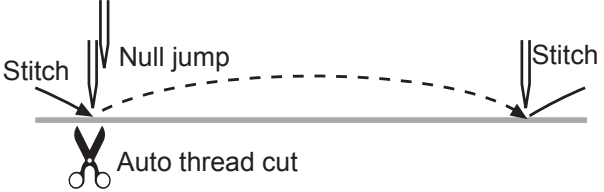
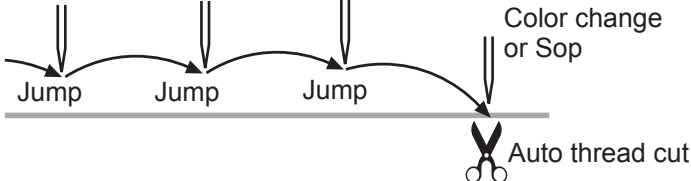
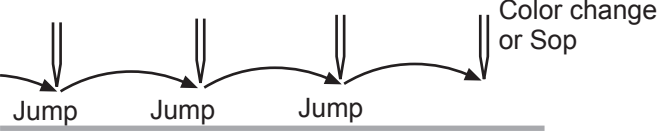

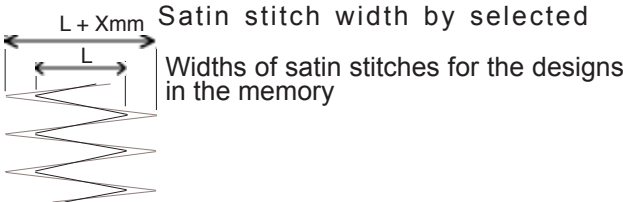


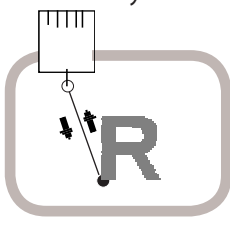

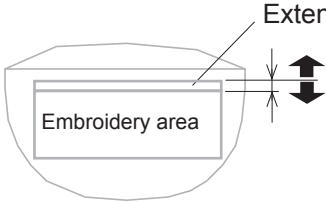


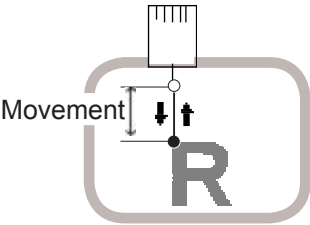


-  The pattern data may be shown.
-  Setting is returned to the default.
-  To return to Menu mode.
-  to return to Drive mode.

Before embroidering, check the basic settings of the machine.




The rest of the settings can be left at default values (as indicated by underline or blue icon).


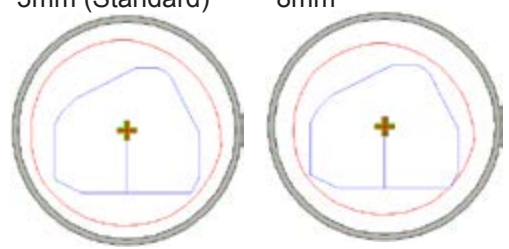

No. Display	Settings (std : Underlined or Blue)	Contents
1 Fine mode	<input type="checkbox"/> YES <input checked="" type="checkbox"/> NO	The machine emphasizes stitch quality by controlling embroidery speed. By default it is set to "NO".
2 Tightness level	 - (Loos) <input checked="" type="checkbox"/> (Normal) + (Tight)	The machine adjusts thread tightness level by controlling the timing of frame move. By default it is set to "Normal".
3 TRD. break back	 1- 50 ( <u>6</u> )... 0 .....	On thread breaks, this causes sewing position & frame to move backwards by several stitches before the detected break before stopping. • The frame will be moved backward by the preset stitch numbers • The frame will not be moved
5 Width data limit	 1 - <u>13</u> mm (13=12.7)	When stitch length exceeds this length, the machine divides it by this jump length and creates multiple movements. Width data limit becomes 12.7mm only when setting value is set to 13. Please use a smaller number when you use thick and heavy material. 
6 Quick start mode	<input checked="" type="checkbox"/> YES <input type="checkbox"/> NO	If you set to "No", the machine will increase speed slowly. Please select "No" when you have a problem with skipped stitches on the beginning stitch after thread trim. YES : The machine sews up to 3 stitches slowly after thread cut. NO : The machine sews up to 5 stitches slowly after thread cut.
7 Auto thread cut	<input checked="" type="checkbox"/> YES <input type="checkbox"/> NO	This performs automatic thread cut after color change and stop.
8 Cut at jump data	 1- 8 ( <u>3</u> ) .	When a set number of continuous jumps exists in pattern data, the machine cuts threads before jumping. • Machine trims the thread on setting number of constant jump. • Does not trim. 


No. Display	Settings (std : Underlined or Blue)	Contents
9 Cut at null jump	<input checked="" type="checkbox"/> YES <input type="checkbox"/> NO	<p>This sets thread cuts before null jumps (Jump without moving)</p> <p>YES : Does trim on empty jump data.</p> 
10 CHG. always cut	<input checked="" type="checkbox"/> YES <input type="checkbox"/> NO	<p>Forces a trim at every color change.</p> <p>YES : Always thread trim before color change.</p>  <p>NO : If data does not have trim function at color change point, machine does not trim.</p> 
11 Length of TRD. cut	<input type="button" value="←"/> <input type="button" value="→"/> Min. Short <u>Normal</u> Long Max. Needle.....	<p>The machine cuts upper threads to a longer length.</p> <ul style="list-style-type: none"> <li>• The upper threads of each needle will be cut off by registered length. <b>P</b>15-3</li> </ul>
13 Width data all	 -1.0~1.0mm <u>0.0mm</u> ....	<p>This is to alter the widths of all satin stitches for all the designs in the memory.</p> <ul style="list-style-type: none"> <li>• Adjust satin stitch width by selected amount.</li> </ul> 
14 TRD. break detect	<input type="button" value="←"/> <input type="button" value="→"/> Off ~ Slow 3~ <u>Norma</u> ~ Quick 3 ~ Needle.....	<p>Sensitivity selection of the thread break detect sensor.</p> <p>Select "Quick" to increase sensitivity.          Select "Slow" to decrease sensitivity.          By default it is set to "Normal".</p> <ul style="list-style-type: none"> <li>• You can set sensitivity of thread break detection needle by needle. <b>P</b>15-4</li> </ul>

No. Display	Settings (std : Underlined or Blue)	Contents
15 Convert cap	<input checked="" type="checkbox"/> YES <input type="checkbox"/> NO	When using cap frame, the vertical direction of the embroidery design should be turned 180 degrees because cap is set on the drive frame upside down. With this function, the vertical direction of the embroidery design will be turned 180 degrees automatically when cap frame is selected on the menu.
16 Revers ramemove	<input type="checkbox"/> YES <input checked="" type="checkbox"/> NO	Frame will be moved in the opposite direction of the arrow key.
17 STR.Auto Position	<input checked="" type="checkbox"/> YES <input type="checkbox"/> NO	When machine is stopped in the middle of design and frame is moved for treating thread, the frame should be returned to last stopped point with Position key. With this function, you just need to press Start button, then the frame will be returned to the last stopped point automatically and start embroidery without pressing Position key.  ○ : Moved point ● : Last stopped point
18 Embroidery weight	<input checked="" type="checkbox"/> Light <input type="checkbox"/> Middle <input type="checkbox"/> Heavy	This setting for heavy duty material depends by material weight. Normally, please select "middle" or "Heavy" for heavy material. Machine speed is decreased automatically, when you select "middle" or "heavy".
19 Expand cap limit	<input type="button" value="←"/> <input type="button" value="→"/>  1 ~ 10mm 0 .....	The direction of Y-axis of the embroidery area (standard) is extended in the direction of the brim of the cap.  If the embroidery area is extended too much, there is a possibility that a needle and pressure foot may hit a frame and may be damaged. Before start sewing, please check carefully the embroidery area by trace function etc.. <ul style="list-style-type: none"><li>• The embroidery area is extended with the set-up size.</li><li>• The embroidery area is not extended.</li></ul>  Extended embroidery area
20 Frameout position	 0 ~ <u>100</u> ~ 330mm	Set movement of frameout in the Framemove.  3-6  ○ : Frameout position ● : Stop position
21 Display inch	<input type="checkbox"/> NO <input checked="" type="checkbox"/> YES	NO : Display the unit of dimensions by millimeters meter. YES : Display the unit of dimensions at an inch.
22 Trace speed	 0 ~ <u>100</u> ~ 300	You can change the Tracing speed. "100" mean the normal speed. If you change the number bigger, the speed decrease.
23 Display off timer	 0 ~ 1 ~ 240 (min.)	The machine turns off the display screen when the time without any operation exceeds the time entered in the parameter. Timer function is "off" when setting value is set to "0"



No. Display	Settings (std : Underlined or Blue)	Contents
24 Design disp mode	<input type="button" value="All"/> <input type="button" value="Change"/>	All : When drive mode, highlight all color change number on the LCD Display. Change: Highlight only current color change number. <div style="display: flex; justify-content: space-around; margin-top: 10px;"> <span>All</span> <span>Change number</span> </div> 
26 Operation Sound	<input type="button" value="YES"/> <input type="button" value="NO"/>	Make beep sound when button or key of touch panel is pressed.
27 Notification Sound	<input type="button" value="YES"/> <input type="button" value="NO"/>	Make beep sound when the machine is stopped.
28 FW/BW Lock Count (1st.)	<input type="button" value="0"/> ~ 100	In "Stitch number forward", when the key is pressed continuously, the "Key lock" function is activated and the frame will move by the one stitch continuously even the finger is released from the key. Set number of stitches until "Key lock" function is activated. The "Key lock" function will be disabled when the number of stitches is set to "0".
29 FW/BW Lock Count (10st.)	<input type="button" value="0"/> ~ 100	In "Stitch number forward", when the key is pressed continuously, the "Fast forward"(ten stitches) function is activated and the frame will move by ten stitches step continuously even the finger is released from the key. In "Stitch number forward ten", when the key is pressed continuously, the frame will move by ten stitches step continuously even the finger is released from the key. Set number of stitches (Stitch number forward) or steps (Stitch number forward ten) until "Key lock" function is activated. The "Key lock" function will be disabled when the number of stitches is set to "0".
30 Cross mark type		Selection of the cross mark (pointer) type.
31 PC Keyboard Layout	<input type="button" value="YES"/> <input type="button" value="NO"/>	Selection of the keyboard layout. YES : PC (QWERTY) NO : Alphabetical order
32 2 Step Frame Return	<input type="button" value="YES"/> <input type="button" value="NO"/>	After the power switch is turned on, the frame (X and Y carriage) will move for Frame Position Initialization. When pre-registered frame is selected, the frame returns as 1 step (X and Y axes move together). When User-defined frame is selected, the frame returns as 2 steps (X and Y axes move individually). This individual movement will prevent the Pressure foot from collision damage with objects (Clamp etc.) of the User-defined frame. Please select "2 Steps Frame Return" when you use the User-defined frames frequently. YES : 2 Step Frame Return NO : 1 Step Frame Return
33 Frame recommend func.	<input type="button" value="YES"/> <input type="button" value="NO"/>	When the embroidery frame is selected, the frame whose embroidery area is smaller than the size of the pattern is displayed in gray. You can select the frame, but needle and/or pressure foot may hit frame and machine and/or frame can be damaged.  3-8a

No. Display	Settings (std : Underlined or Blue)	Contents
34 Embroidery area margin	 1 ~ <u>3</u> ~ 10mm	Change the margin of embroidery area. If you increase the margin of the embroidery area, risk of damage the machine will be reduced by cauce of needle or ressure foot hit the frame. Setting example      3mm (Standard)      8mm 
35 Buzzer stop time	 <u>Repeat</u> (Continue) 1 sec. ~ 5 min.	Change the time of the buzzer that sounds when the machine stops.

1. When the machine is stopped, press .



2. Select "OPTION".



3. Select .



4. Select desired setting item and change the setting.

You can move to next page by pressing .

Press  to return to Menu mode.

Press  to return to Drive mode.

## Detailed explanation of machine settings



### 11 Length of TRD.cut


If you select “Needle” with this setting, the upper threads of each needle will be cut off by registered length.

The length of each thread can be set up taking the following steps.

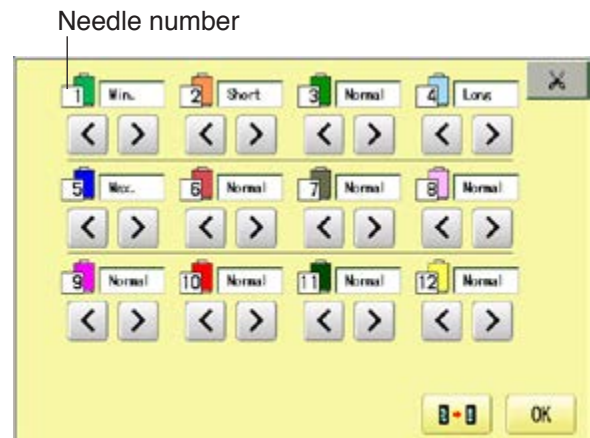
1. Follow the steps 1.- 3. on the previous page and the display shows machine setting page.

2. Press  .

3. Change the setting on the needle number you would like to change with   .

Press  when returning the setting on all the needle numbers to default.

4. Press  .

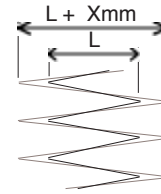


## 13 Width data all

This function adds additional width to all satin stitches in a design.

This is otherwise set in the “Settings” function ( 14-3), in which case any changes made to the setting from this screen will have no effect.

Width data all



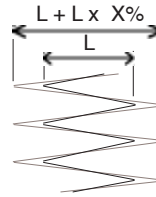
Setting : X mm

You can also set detailed adjustment with using “Width data multi-step” function.

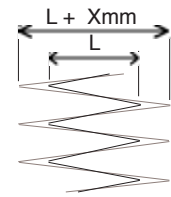
Please note that the value of “Width data all” should be set “0.0mm” to activate above function.

The step of setting is as follows.

Width data multi-step



Setting : X%



Setting : X mm

1. Follow the steps 1.- 3. on the previous page and the display shows machine setting page.

2. Press

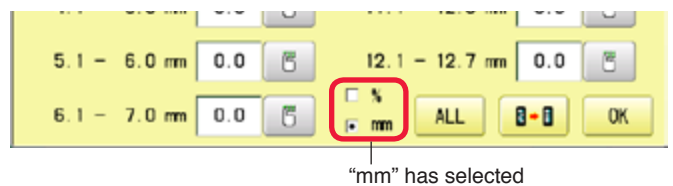
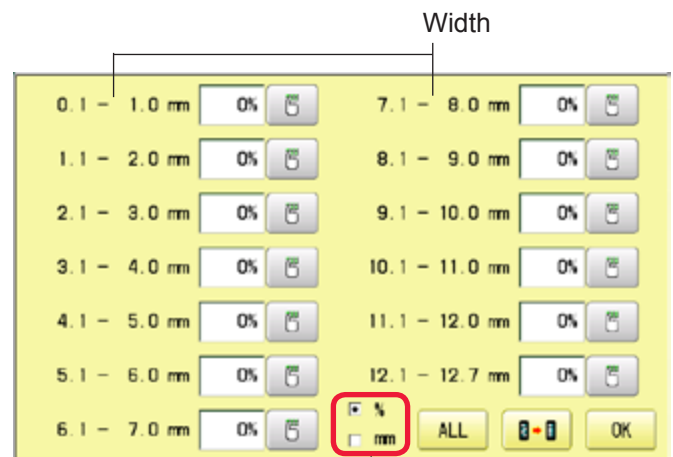
3. Change the setting on the each width you would like to change with

You can select the “%” or “mm”.

Press when the setting on all the each width.

Press when returning the setting on all the each width to “0% “ or “0.0mm”.

4. Press





## 15 TRD. break detect


If you select “Needle” with this setting, you can set sensitivity of thread break detection needle by needle.


You can be set up taking the following steps.

1. Follow the steps 1.- 3. on the page 5-2a and the display shows machine setting page.

2. Press .

3. Change the setting on the needle number you would like to change with  .

Press  when returning the setting on all the needle numbers to default.

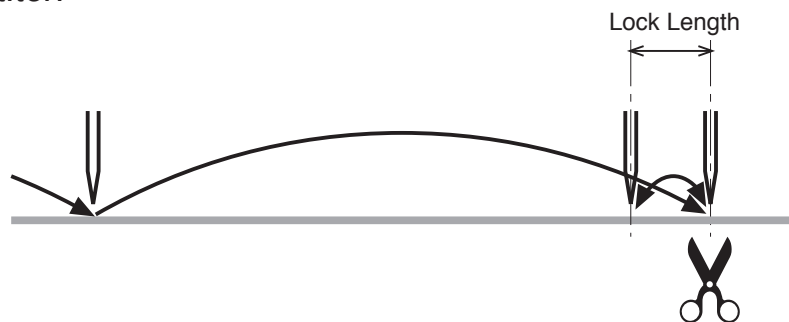
4. Press .



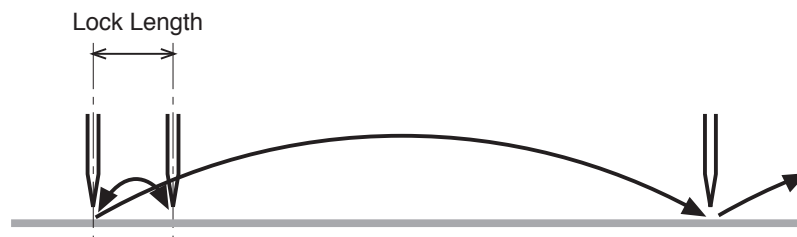
This machine adds lock stitches automatically as default setting at start and thread cut point. These lock stitches prevent upper thread from fraying and coming off from needle hole. The length and number of lock stitches (start / thread cut) can be adjusted with following setting items.

- \* At start of embroidery, if upper thread comes off often even default setting, it is recommendable to change setting of STR. Lock stitch from AUTO to ON and adjust STR. Lock Length longer.


## Ex. Cut Lock stitch



## Ex. STR. Lock stitch



SETTING ITEM	SETTING RANGE (Default is underlined)	CONTENTS
1 Cut Lock stitch	OFF ON <u>AUTO</u>	: Remove lock stitch when the machine cuts threads. : Add lock stitch per SETTING ITEM 2 and 3 when the machine cuts threads. : Add lock stitch when length of the stitch before thread cut is longer than length set at SETTING ITEM 2.
2 Cut Lock Length	0.4~ <u>0.7</u> ~1.2mm	: Set lock stitch length when "ON" or "AUTO" on SETTING ITEM 1 Cut Lock stitch is selected.
3 Cut Lock Count	1 ~ <u>2</u> ~ 3	: Set number of lock stitch when "ON" on SETTING ITEM 1 Cut Lock stitch is selected.
4 STR. Lock stitch	OFF ON <u>AUTO</u>	Add Lock stitch when the machine starts sewing. : Remove lock stitch when the machine starts. : Add lock stitch per SETTING ITEM 5 and 6. : Add lock stitch when length of the stitch before the machine starts sewing cut is longer than length set at SETTING ITEM 5.
5 STR. Lock Length	0.4~ <u>0.7</u> ~1.6mm	: Set length of lock stitch when "ON" or "AUTO" on SETTING ITEM 4 Cut Lock stitch is selected.
6 STR. Lock Count	1 ~ <u>2</u>	: Set number of lock stitch when "ON" on SETTING ITEM 4 Cut Lock stitch is selected.

1. When the machine is stopped, press .




2. Select "OPTION".



3. Select .

4. Select desired setting item and change the setting.

Press  when returning the setting on all the needle numbers to default.



Press  to return to Menu mode.

Press  to return to Drive mode.




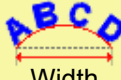



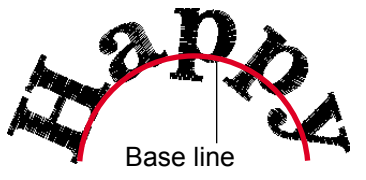
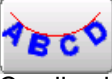
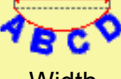

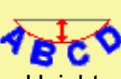


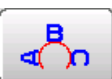




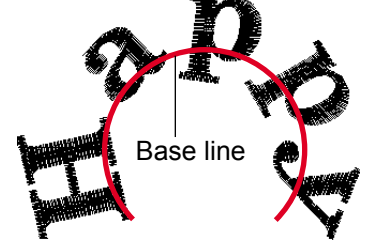





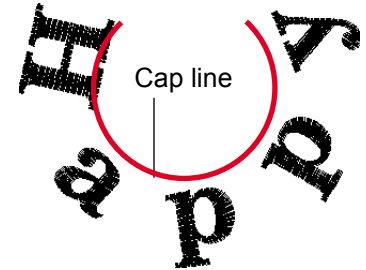
Selecting letters using the built-in fonts.

You can create monogramming data by using built-in alphabet, numbers and symbols.


You can choose layout method of monogramming data from horizontal, arch, or circle layout.

Save lettering embroidery data to design memory automatically.

## Layout method

<p> <b>Horizontal</b> (straight line)</p> <p>Base line is horizontally laid out.</p>	<p>Increase or decrease by 5(mm or degrees)      Set by entering value.</p>	<p>Cap line</p>  <p>Base line</p>
<p> <b>Arch (upward)</b></p> <p>Increase or decrease by 5. Set by entering value. Baseline is formed a round arch in an upward direction. Change settings of baseline's width and height. Press <b>SET</b> after setting is firmed.</p>	<p> Width      <b>-</b>      <b>+</b>      </p> <p> Height      <b>-</b>      <b>+</b>      </p>	 <p>Base line</p>
<p> <b>Arch (downward)</b></p> <p>Cap line is formed a round arch in a downward direction. Change settings of capline's width and depth. Press <b>SET</b> after setting is firmed.</p>	<p> Width      <b>-</b>      <b>+</b>      </p> <p> Height      <b>-</b>      <b>+</b>      </p>	<p>Cap line</p>  <p>Cap line</p>
<p> <b>Circle (upward)</b></p> <p>Baseline is formed a circle in an upward direction. Change settings of baseline's diameter and angle. Press <b>SET</b> after setting is firmed.</p>	<p> Diameter      <b>-</b>      <b>+</b>      </p> <p> Angle      <b>-</b>      <b>+</b>      </p>	<p>Cap line</p>  <p>Base line</p>
<p> <b>Circle (downward)</b></p> <p>Capline is formed a circle in an downward direction. Change settings of cap line's diameter and angle. Press <b>SET</b> after setting is firmed.</p>	<p> Diameter      <b>-</b>      <b>+</b>      </p> <p> Angle      <b>-</b>      <b>+</b>      </p>	<p>Cap line</p>  <p>Cap line</p>



1. When the machine is stopped, press  .




2. Select "LETTER".



## Letter selection

Select letters. One data can contain up to 26 letters including space.

3. Select letter.

 The screen is switched to basic script or cyrillic script.


 All the letters are deleted.

 Basic script



 Biacritic script

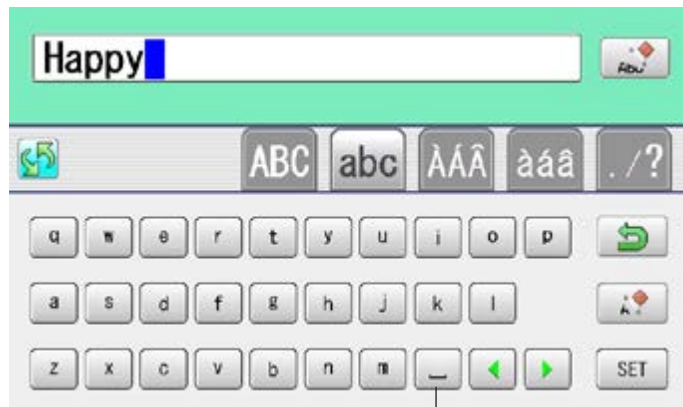
 Cyrillic script

 Symbol

 The screen returns to menu.

 Selected letter or number is deleted.


  The cursor moves left and right.





Space or Delete

Except for the space between letters, space is eliminated.



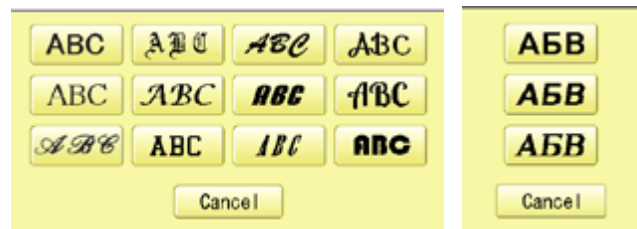
The display of Cyrillic script after pressing .

4. Press  when you are finished with the letter selection.

Fix your setting and you can select fonts.  
For fonts, refer to [BUILT-IN FONT LIST].  26-3

Basic script (Diacritic)

Cyrillic script

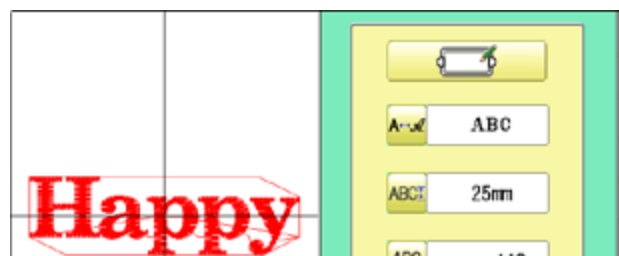


## Font Selection

Enables you to select the preferred font.  26-3


5. Select the font.

Fix your setting and go to next step.



## Letter Height selection

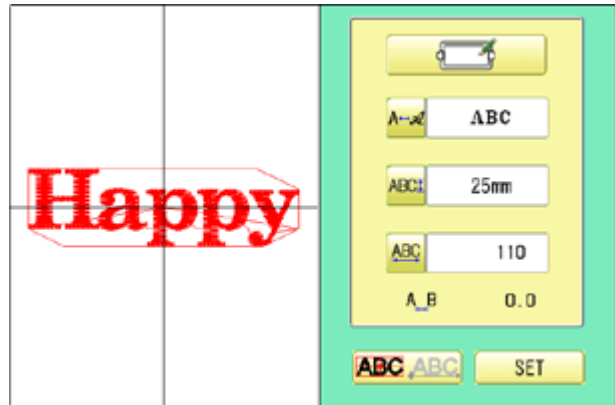
Select the letter height.

6. Select .




7. Select desired height.

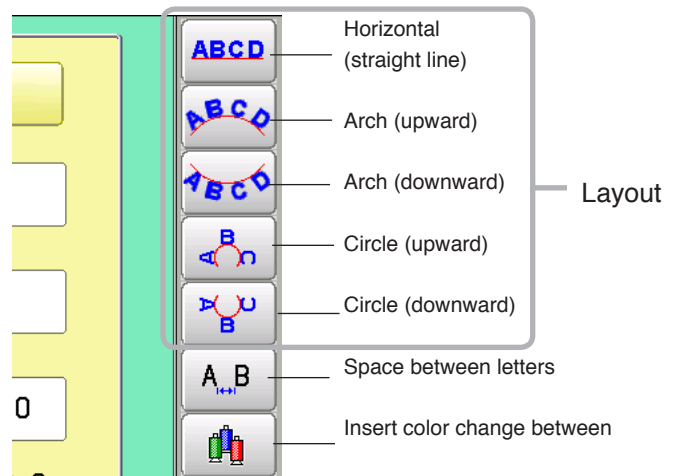
After the height setting is fixed and now line length can be selected.



## Layout method


Select layout method.

8. When you would like to change layout method, select either layout method from the right submenu.  16-1  
Initial layout method is horizontal (straight line).




## Line Length

When layout method is “horizontal “, you can change line length.  
For other layout method than “horizontal”, line length is not used.

9. Select  when “horizontal” in layout method is selected.  
Go to the procedure when other style than “horizontal” in layout method is selected.





9. Select the number.

 Setting is canceled.




10. Press .


 Return to the Letter selection.


 Return to the Font Selection.

 Return to the Letter Height selection.

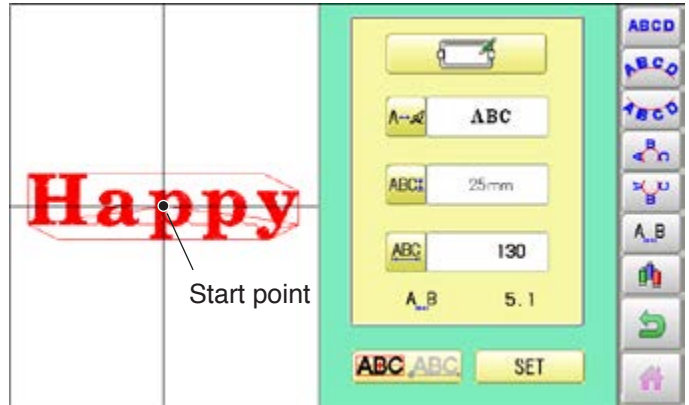
 Return to the Line Length.

You can change start point of monogramming data.

 : Start point is the center of monogramming data.

 : Start point is the center of monogramming data.

Start point is the center of baseline or capline for “arch” and “circle” layout.




## Create

You can create embroidery data from the letter settings.

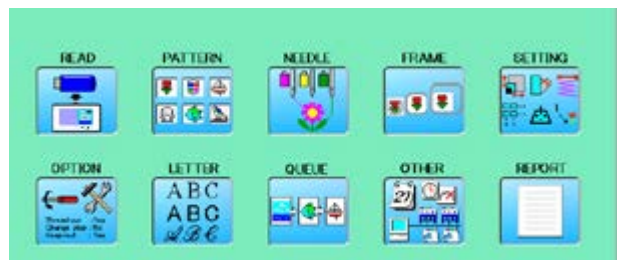
11. Press .

The new pattern data will be created. Then you will return to menu mode.

Press  and go to Running Screen.

You can see letter created as embroidery data.

The first 8 letters will be shown as the name of the pattern which you have made by letter selection.

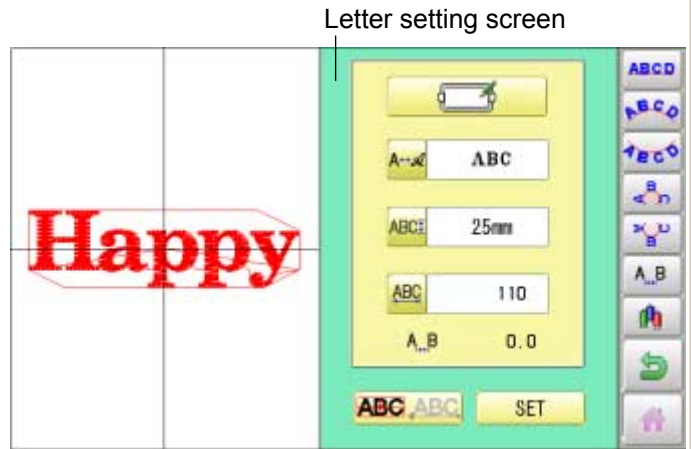



Press  to return to Menu mode.

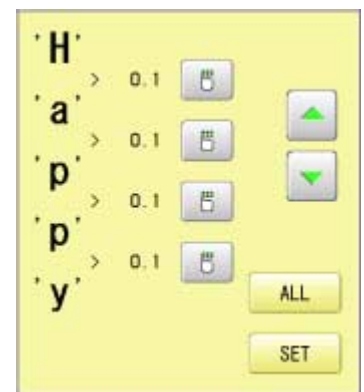



## Space between letters

Space can be added between letters.



1. Press  on the letter setting screen.




2. Select  on space between letters you would like to change.




3. Enter value.



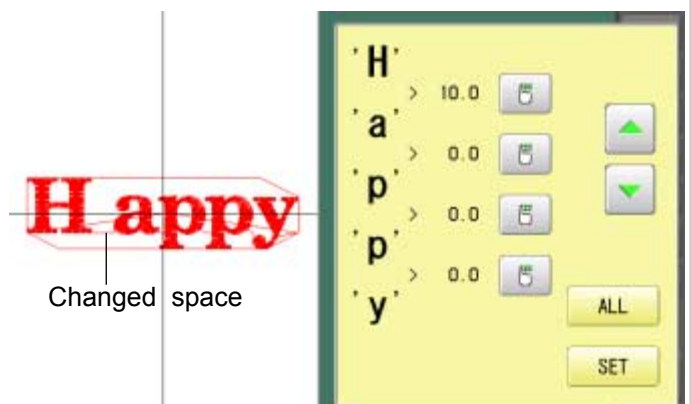
4. Press .

When you would like to make the same value on all the space at the same time select

 and enter value of the space.

Press .

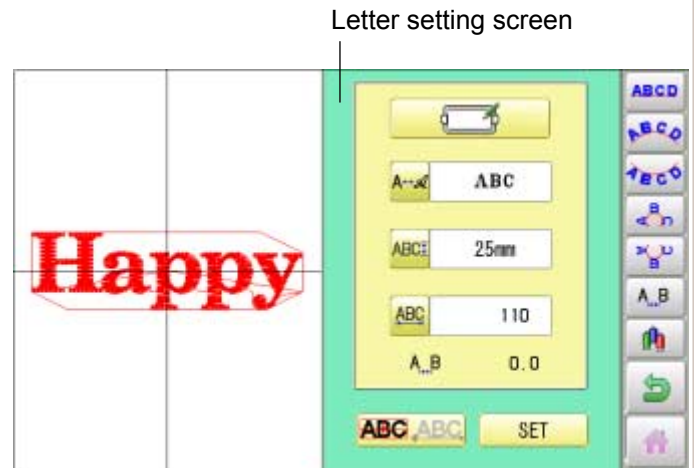
All the space settings are firmed.




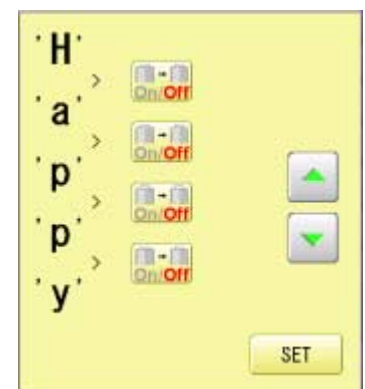



## Color change between letters


Color change can be made between letters.




1. Press  on the letter setting screen.






2. Select  on space between letters you would like to change.

 Setting of space between letters is ON.

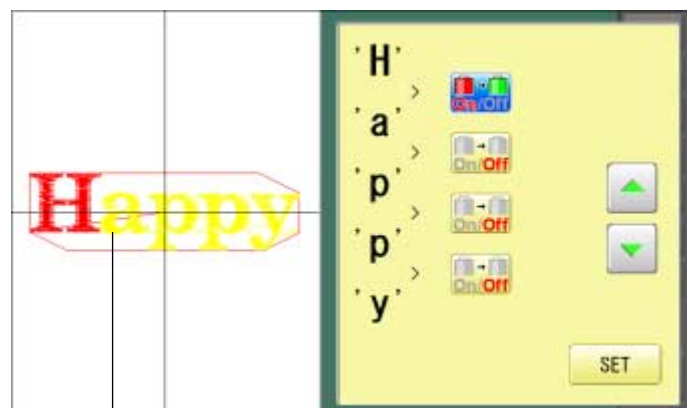
 Setting of space between le is OFF.

Setting of space can switched by pressing

 and .


Press .

The settings are firmed.



Color change setting is made

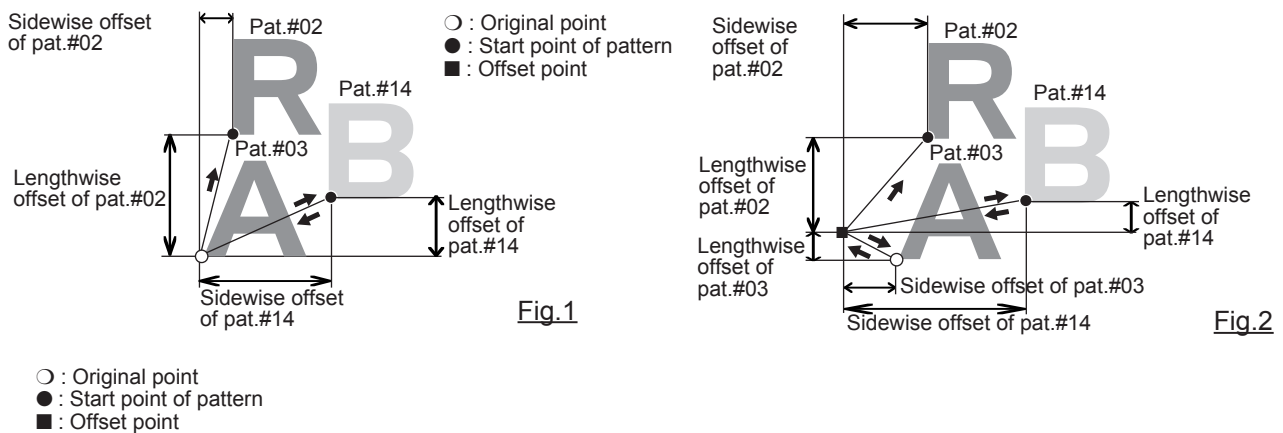
- When color change setting is made for the space between letters you can set needle number of the letters of both sides of the space whose color change setting is ON.

 3-9, 5-E

This sets up a succession of patterns that can be embroidered in any desired sequence. The machine will proceed with the \*various settings set to each pattern.

- If you embroider a pattern like in Fig.1, you will need to set an offset as a pivot to each pattern in advance. If the offset is set to the first pattern like in Fig. 2, you will need to set a setoff point to the first pattern with the offset of the other pattern as a pivot. P14-8
- If automatic original point return is set, the machine will return to the original point when finished. If automatic original point return is not set, the embroider will finish at the end point of the last pattern.

## Setting example



## Alter and Execution

This registers Queued patterns in order, and executes.

## Needle bar selection and Pattern settings

Needle bar selection and Pattern Settings for patterns selected to QUEUE operation can be applied by the following steps.

## Registration of QUEUE setting

Up to 10 QUEUE settings can be registered.

## Read QUEUE setting


Read registered QUEUE setting.

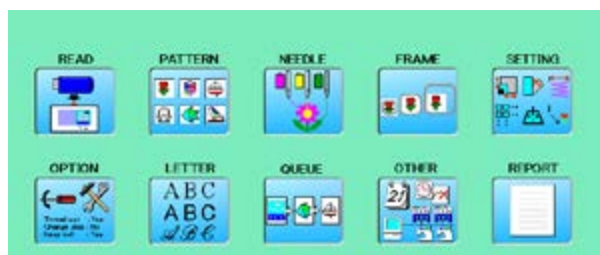
## Alter and Execution

This allows you to sew any combination of designs in sequence (up to 30 designs), and executes.

Once "QUEUE" is set, the pattern data registered and set in the "QUEUE" is embroidered until pattern data in "READ" is selected.

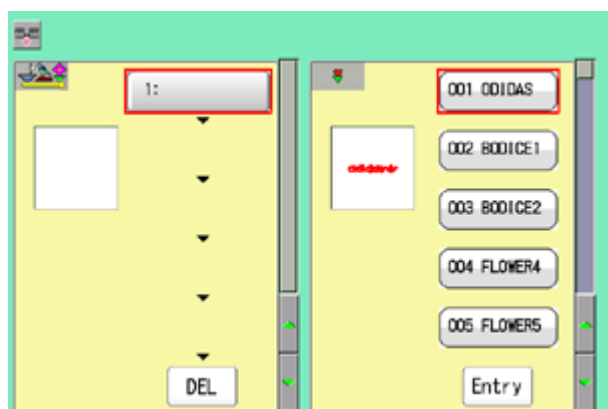
Therefore, you need to select other pattern data in "READ" to cancel QUEUE.

1. When the machine is stopped, press .



2. Select "QUEUE".

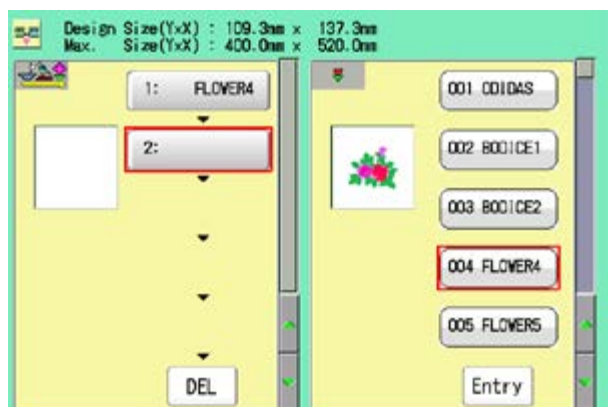
The left side shows the pattern data.



3. Select desired pattern and press .

The selected pattern is shown to the left.

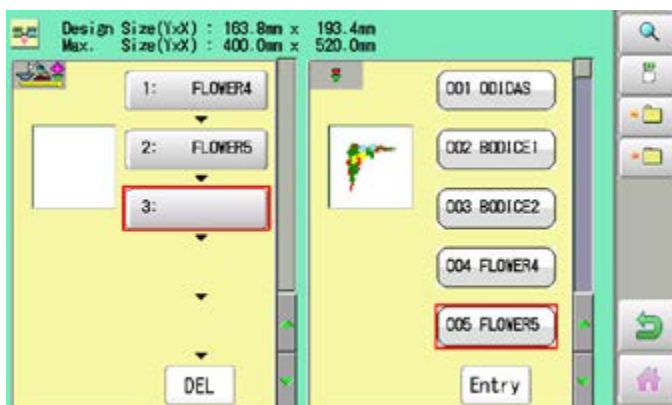
If you need to erase the design, press .



4. Select desired pattern and press .

The selected pattern is shown to the left.

If you select other memory pattern data continuously, repeat step 4.

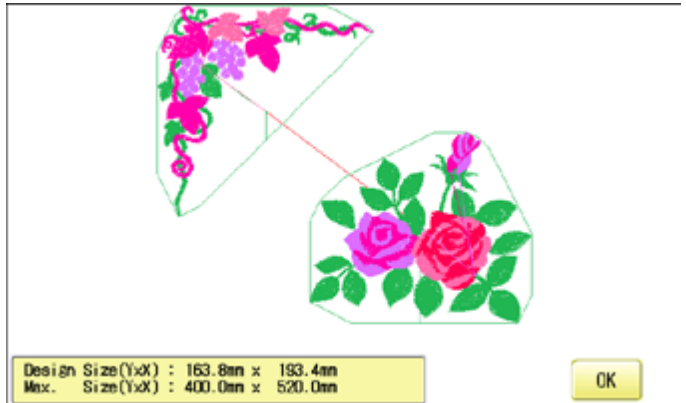


5. Combined design can be seen on Screen.  
To show combined design, please press

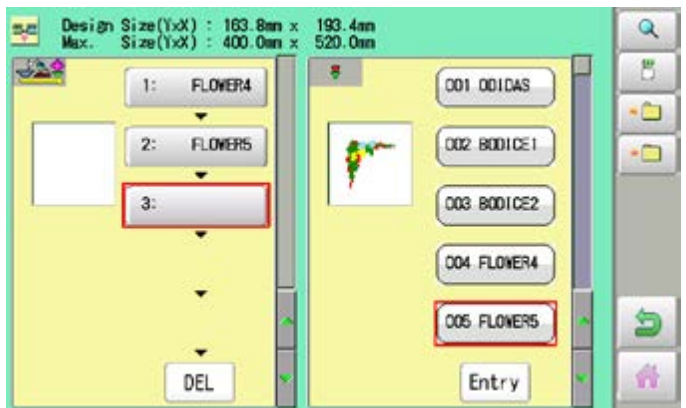


Illustration of the pattern selected will be displayed.

In case you do not need to check combined design, please go to step no.7.

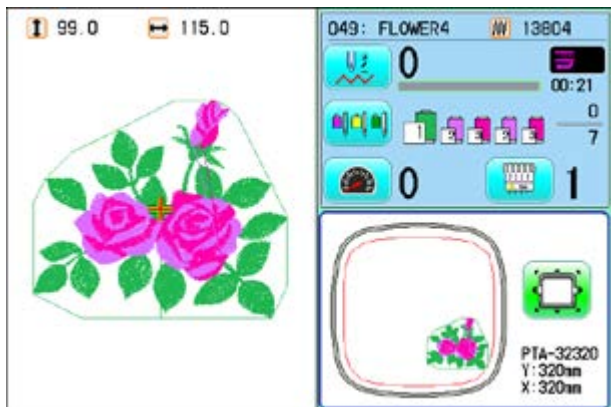


6. Press .



7. Press .

--- Check pattern data ---



8. Press .


The machine will start a Queue embroidery with Queue operation in registered order.  
After finishing your last design, the display will show ">>End" and the machine will stop.

>>End



## Needle bar selection and Pattern settings

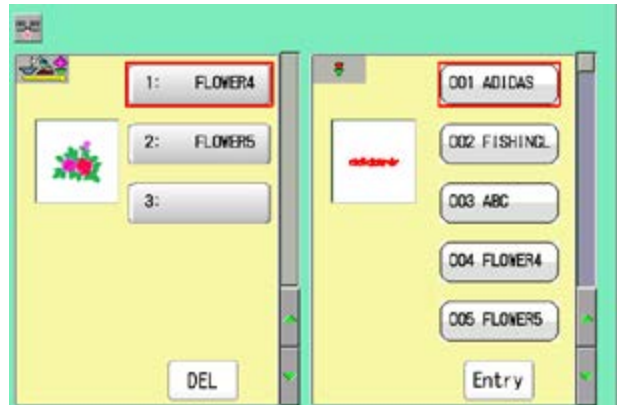
Needle bar selection and Pattern Settings for patterns selected to QUEUE operation can be applied by the following steps.

1. When the machine is stopped, press .

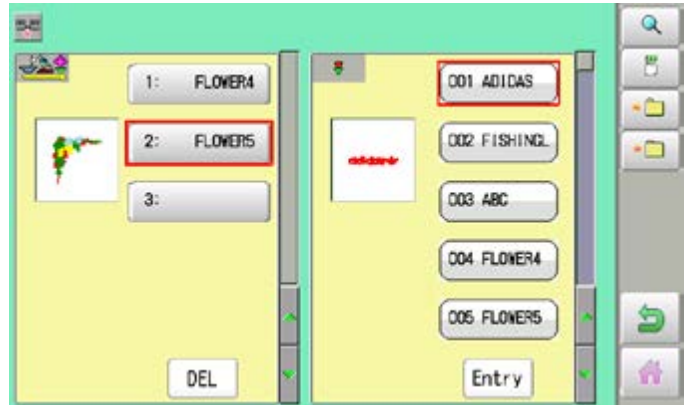



2. Select "QUEUE".

The selected pattern is shown to the left.





3. Select desired pattern.



4. Press .



5. Select desired setting.


Please refer pages mentioned below for setting.  
 "Needle bar selection"  5-E,  
 "Pattern settings"  14-1

Needle bar selection

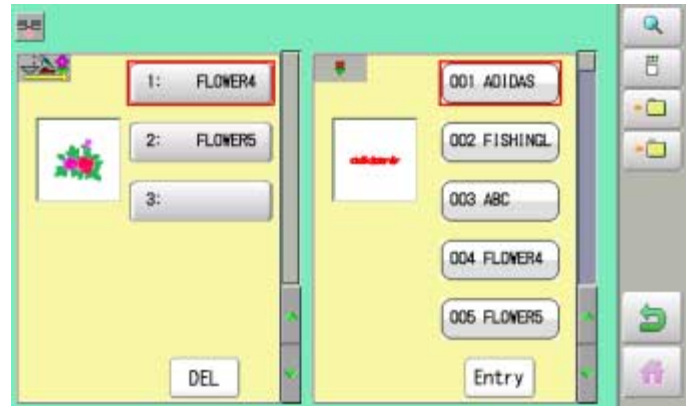



Pattern settings



6. After setting, press .

For setting of "Needle Bar Selection"[NEEDLE] and "Pattern Setting"[SETTING] to other design, please do steps no.3-7.



Press  to return to Menu mode.

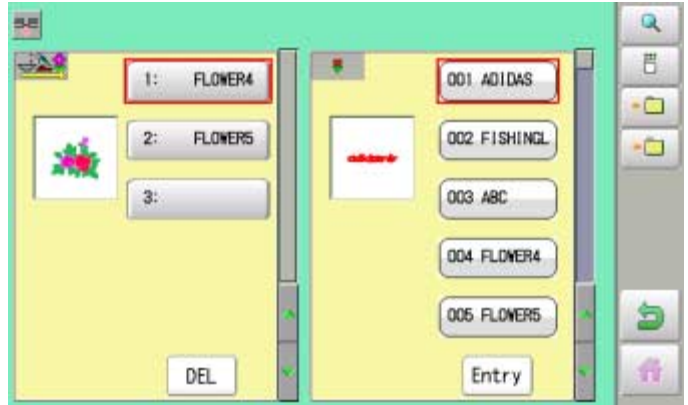
Press  to return to Drive mode.

## Registration of QUEUE setting

Up to 10 QUEUE settings can be registered.

Once you register QUEUE you can select registered QUEUE setting anytime.

1. According to step 1-8 of "Alter", select patterns.




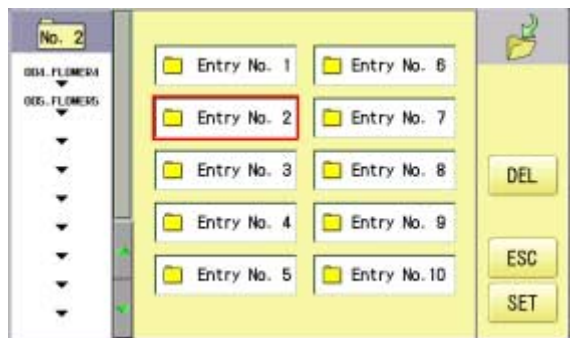
2. Select .



3. Select registration No. and press .

When pattern data is not displayed on the left side on the screen, no pattern data is registered in the holder of the setting No.

 Registration is deleted.




4. Press .

QUEUE setting is registered as setting No.2.




Press  to return to Menu mode.

Press  to return to Drive mode.

■ In case you delete pattern from machine memory, QUEUE setting which has deleted pattern will be deleted too. (Erasing patterns from memory  5-B)

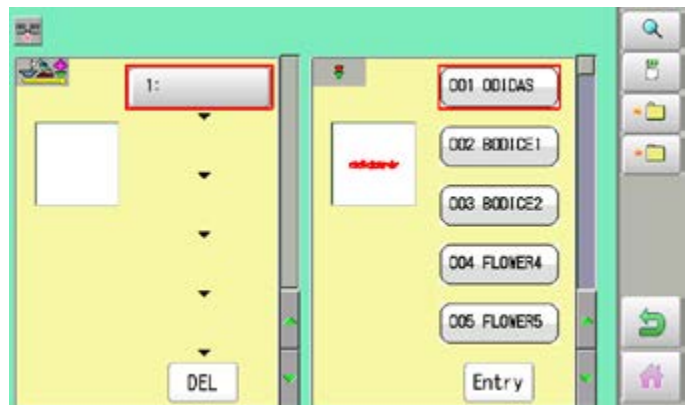
## Read QUEUE setting

Read registered QUEUE setting.

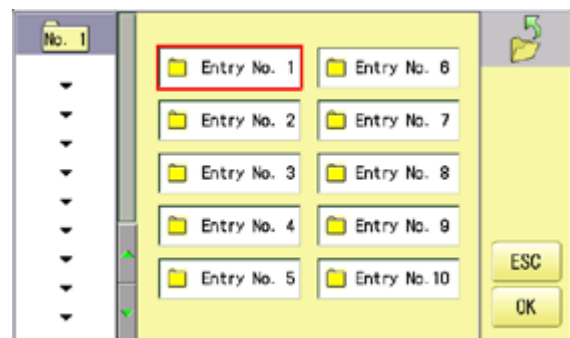
1. When the machine is stopped, press .



2. Select "QUEUE".

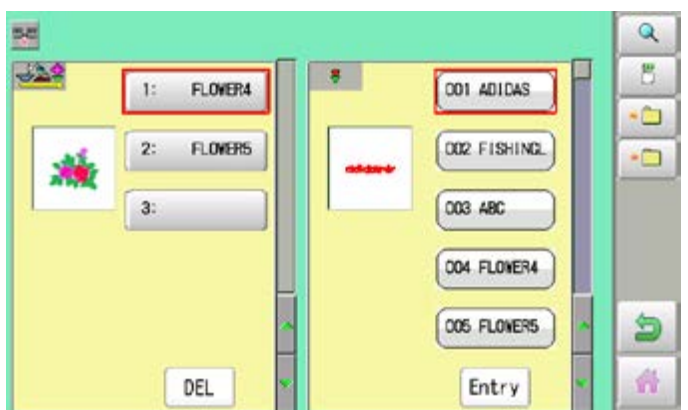


3. Select .



4. Select number and press .

QUEUE setting is selected.



Press  to return to Menu mode.

Press  to return to Drive mode.

## ● Create network

Network setting is required in order to connect the embroidery machine with PC's network management software (HAPPY link LAN) .

You do not have to do this setting when you do not connect the machine with the network.

There are two types of connecting method such as Wired and Wireless LAN connection.

You need to have wireless LAN function, it is necessary to install the WiFi USB adapter (option) on the embroidery machine in advance.

- You cannot use both Wired and Wireless LAN connection at the same time.  
Select either connection method.
- Note: HAPPY link LAN is a software designed to be used at LAN (Local Area Network) connection between the software installed PC (server) and the software-enabled embroidery machine(s).  
If this network is connected with other network, you might not be able to communicate due to the overlapping of IP address and other code.  
If PC or machine that is connected with other network has to be inevitably connected with Happy link LAN, you might change network settings as specified in this manual.  
In this case, the settings are required by your network administrator or person(s) of network knowledge.
- If communication does not work or the operation is unstable even if the network is set properly, perform "Initialize the Network" in "Re-Initialization of machine system" and try the settings again. 25-1

### Installing the WiFi USB adapter (option)

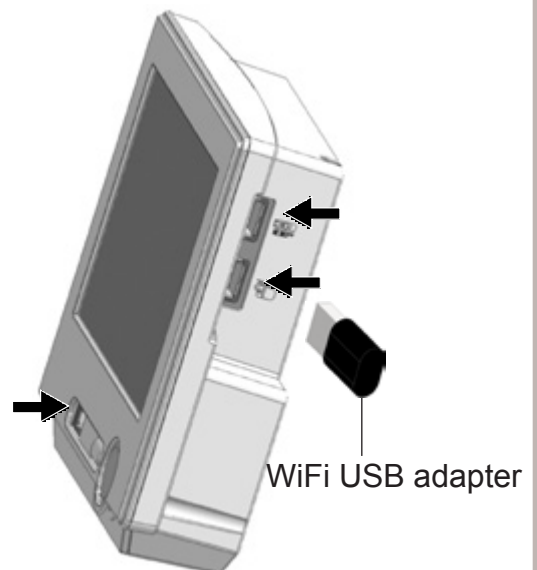
In addition to the WiFi USB adapter we supply as an option, the following products can be used.

The WiFi USB adapter must use the product certified by the radio wave in your country. Contact your distributor or retailer for more information.

Model	Manufacturer
DWA-131 (H/W Ver. E1)	D-Link
EP-N8508GS	EDUP
LM007	LM Technologies
TL-WN725N	TP-Link
TL-WN823N	TP-Link

With the embroidery machine switched off, Insert the WiFi USB adapter all the way into the USB flash drive port of the machine (front or right side of control box). As soon as you turn on the power of the embroidery machine, you will be able to set up the wireless LAN connection. 18-2e

- Be sure to turn off the machine when removing the WiFi USB adapter.



## Wired LAN connection

Wired LAN connection create network connection between the embroidery machine and PC with a LAN cable.

There are 2 types of Wired LAN connection methods.

### HUB connection

PC via switching HUB connects with the embroidery machine.

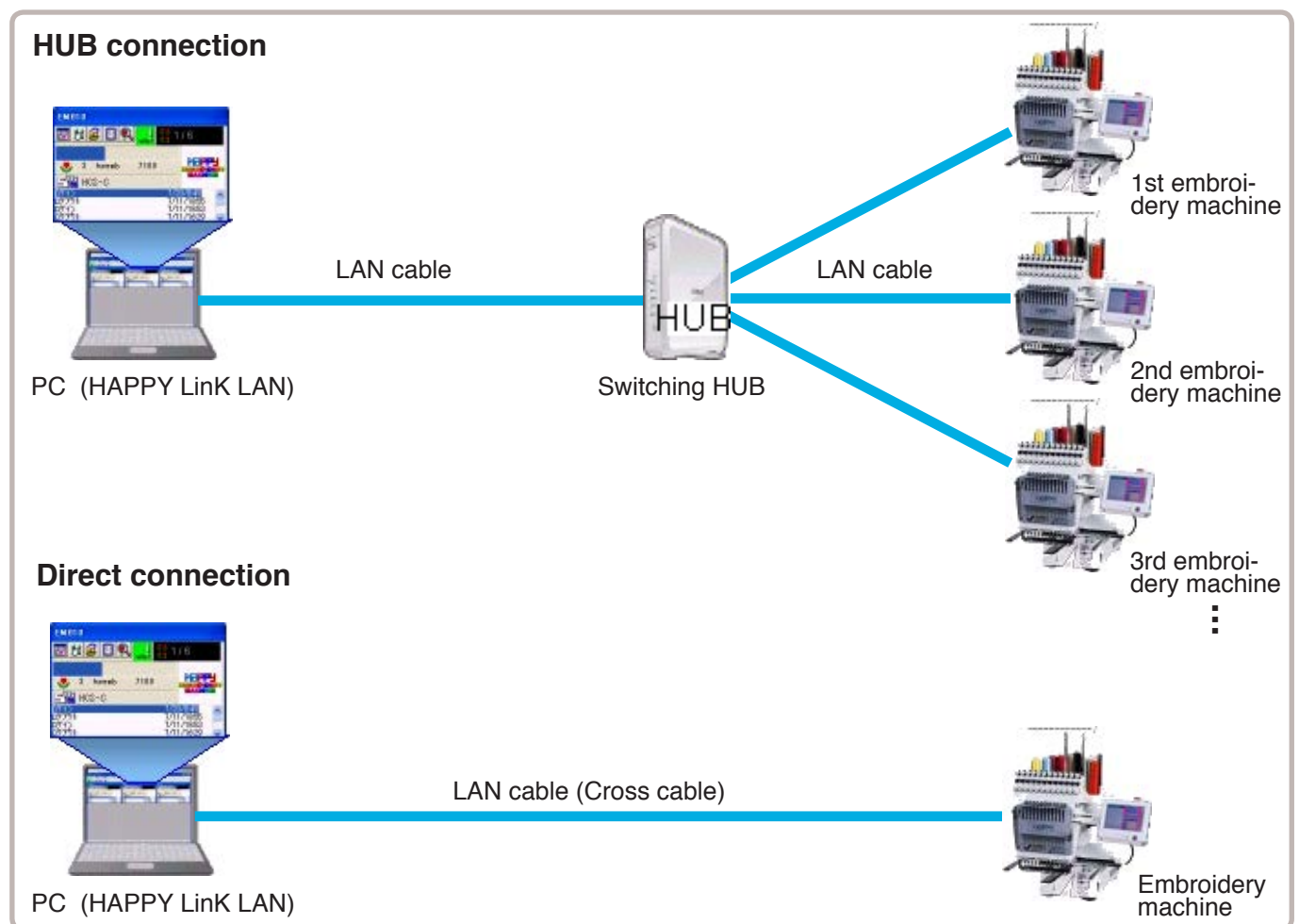
You can connect PC with multiple embroidery machines.

### Direct connection

You can connect PC with a machine with crossover cable and without HUB if you connect PC with only one machine.

However, a straight cable can be also used for this connection if your PC's LAN port recognizes the type of cable.

You cannot connect PC with multiple embroidery machines.

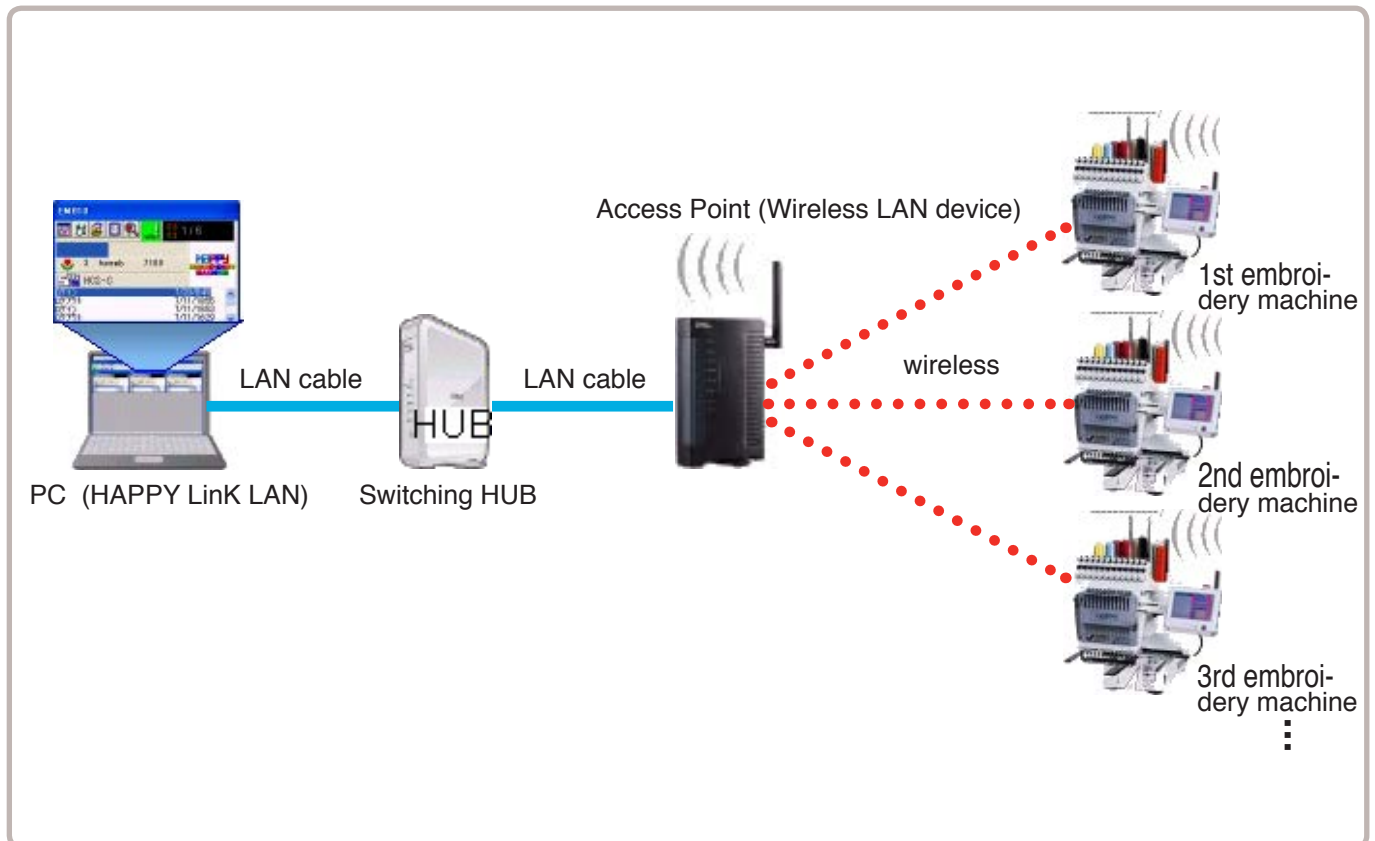


## Wireless LAN connection

Wireless LAN connection creates network connection between the embroidery machine and PC with wireless LAN.

You can connect PC with embroidery machines via Access point (Wireless LAN device).

You can connect PC with multiple embroidery machines.



## ●Wire LAN connection setting

Set the value based on network management software (HAPPY link LAN).

Boot the network management software (HAPPY link LAN) on the PC before setting the embroidery machine.

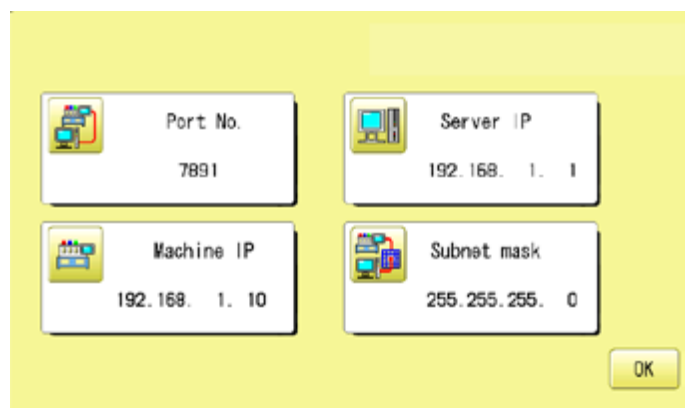
1. When the machine is stopped, press



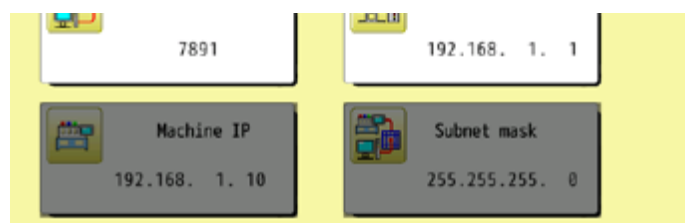
2. Select "OTHER".



3. Press





If the LAN cable is not connected, the "Machine IP" and "Subnet mask" will be displayed in gray and cannot be set. Check the connection.





4. When you set values on the embroidery machine as the 1st machine connected to network, check if each setting item shall be default settings.

Press  and  and move to operation no 9 if there is no change of setting required.

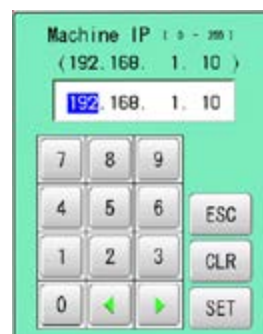
### Default settings

Port No. : 7891  
 Server IP : 192.168. 1. 1  
 Machine IP : 192.168. 1. 10  
 Subnet mask : 255.255.255. 0

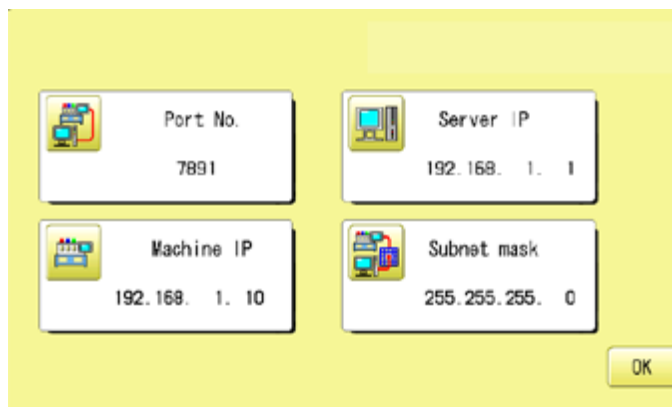
Set values on the 2nd machine or later machine based on the following "Setup of Machine IP address".

Press  to change.

Press right /left of   to select the setting point.



5. Press .



## Setup of Machine IP address

Examples : 192.168. 1.

If you have 2 or more machines, add one to the number enclosed in boxes on the right corner of Machine IP address like the examples shown below.

Leave other values than Machine IP address as they are and do not make any changes of these values.

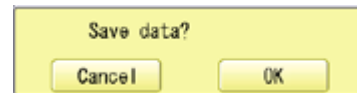
Add one to default value [10] such as [11] for 2nd machine and [12] for 3rd machine.

Machine IP address is a Decimal number.

Machine IP address is shown by incrementing the number by one as follows.

10, 11, 12, 13, 14, 15, 16, 17, 18, 19, 20, 21, 22, 23, 24, 25, 26, 27 ~

6. Press .



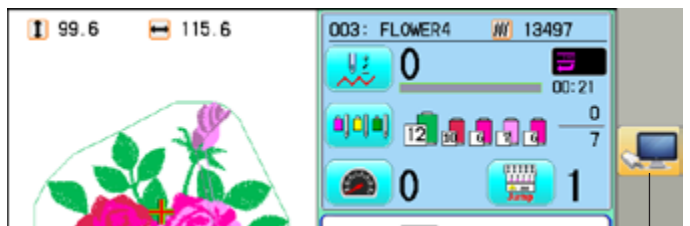
7. Press .

The display returns to MENU.



9. Press  or .

The machine will automatically connect with HAPPY link LAN booted on the PC.



LAN connection indicator is displayed.

LAN connection indicator

If LAN connection indicator is not displayed in the screen, refer to the following causes and countermeasures.

## Causes and countermeasures

- ① Is IP address overlapped on the machine with other machine that creates LAN connection?  
If so, set IP address so that IP Address on each machine is not overlapped.
- ② "HAPPY link LAN" is not booted.  
If not booted, boot "HAPPY link LAN" on the PC. LAN is not recognized before HAPPY link LAN is booted.
- ③ Is IP Address in "HAPPY link LAN" set correctly?  
Set up the IP Address correctly based on the "HAPPY Link LAN" manual.
- ④ Are PC network settings set correctly? Set up the PC network settings correctly based on the "HAPPY Link LAN" manual.

## ● Wireless LAN connection settings (Option)

Boot network management software “HAPPY link LAN” on the PC before set up on the machine. Connect and enable a commercially available wireless network device on the PC. Follow the instruction manual for the wireless LAN device regarding its connection and settings.

Record the following information when you set up wireless LAN device or connect the machine with enabled wireless LAN device.

The following information is required when settings of wireless LAN device on the embroidery machine are made.

### **SSID (Service Set Identifier)**


Identifier of wireless LAN device

### **Network key**

Network keys are case sensitive (distinguish uppercase and lower case letter). You must enter exactly the same network keys including the number of letters you set up.

# OTHER SETTINGS


# 18-2f

1. When the machine is stopped, press .

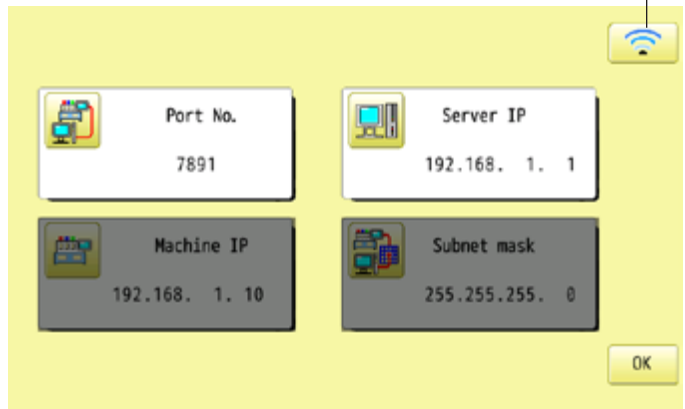


2. Select "OTHER".



It shows that the WiFi USB adapter is plugged in.  18-1

3. Press  Network.

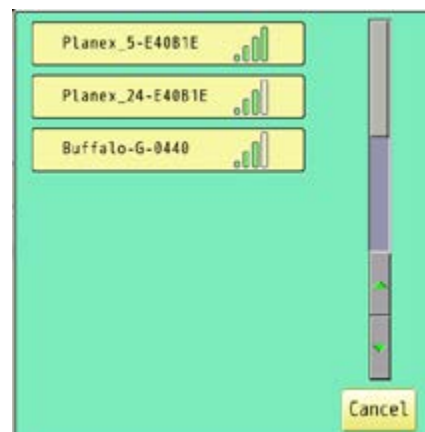


4. Press .

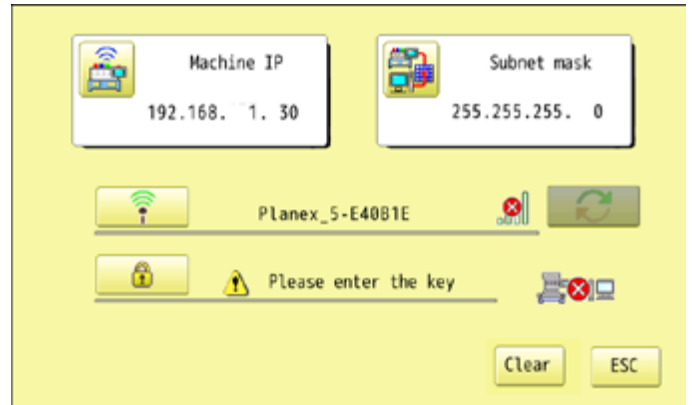


5. Press .

Connectable access point is displayed in the screen.



6. Select access point you would like to connect with the machine.









7. Press .



8. Enter Network key, and press .

Network keys are case sensitive (distinguish uppercase and lower case letter). You must enter exactly the same network keys you set up as well as the same number of letters.


-   The cursor moves left and right.
-  Uppercase and lowercase letter are switched.
-  All the letters are deleted.
-  Selected letter or number is deleted.
-  Renaming is cancelled.



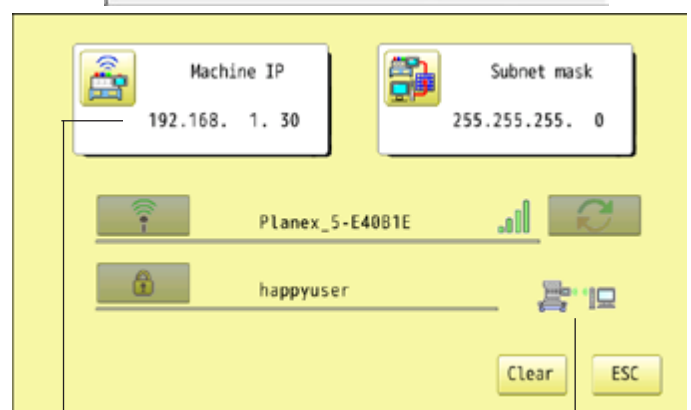
Network key

9. Press .

The embroidery machine makes wireless LAN connection.

Press  and restart operation no. 5 to cancel the settings.

While setting up WLAN



Machine IP address for wireless

The icon indicates connection is made.

10..When you connect an embroidery machine with network as the 1st machine to connect, check if Machine IP address for wireless and Subnet mask on the machine shall be default settings.


When change is not required, please jump to operation no.12.

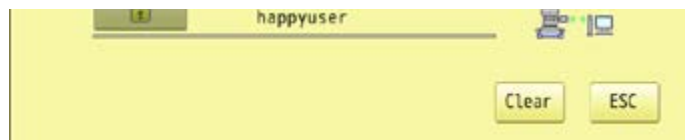
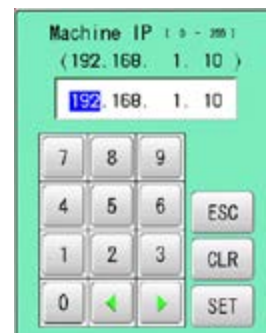
Default settings

Machine IP : 192.168. 1. 30  
Subnet mask : 255.255.255. 0

Set values on the 2nd machine or later machine based on the following "Setup of Machine IP address for wireless".

Press  to change.



Press right /left of   to select the setting point.



11. Press .

## Setup of Machine IP address for wireless

Examples : 192.168. 1. XX

When you create wireless LAN connection, you need to set up  Machine IP address and  Machine IP address for wireless.

You need to avoid IP address overlaps between Machine IP address and Machine IP address for wireless.

If you have 2 or more machines, add one to the number enclosed in boxes on the right corner of Machine IP address like the examples shown below.

Leave Subnet mask at default and do not make any changes.

Add one to default value [30] such as [31] for 2nd machine and [32] for 3rd machine.

Machine IP address is a Decimal number.

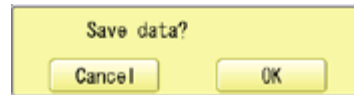
Machine IP address is shown by incrementing the number by one as follows.

30, 31, 32, 33, 34, 35, 36, 37, 38, 39, 40, 41, 42, 43, 44, 45, 46, 47 ~

12. Press .



13. Press .



14. Press .

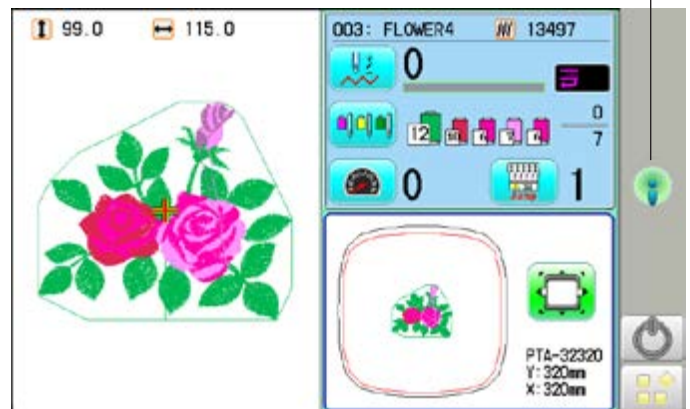


15. Press  or .

Wireless connection indicator is displayed if wireless connection is set up correctly.

If wireless connection indicator is not displayed. Check wireless connection settings.

Wireless LAN indicator

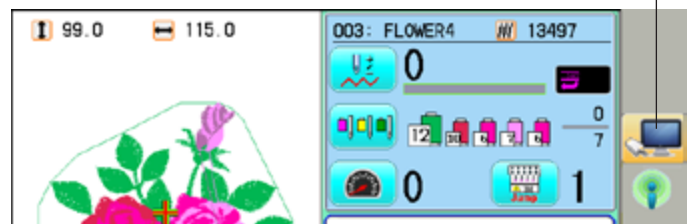


The machine is automatically connected with "HAPPY link LAN" booted on the PC.

Then, LAN c indicator is displayed.

Refer to the following cause and countermeasures if LAN connection indicator is not displayed.

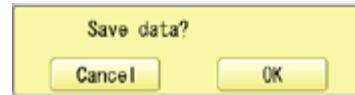
LAN connection indicator



## Causes and countermeasures

- ① Is IP address overlapped on the machine with other machine that creates LAN connection?
- ② LAN cable is connected between the embroidery machine and the PC.  
Remove LAN cable from the machine once and create wireless LAN connection settings.
- ③ "HAPPY link LAN" is not booted.  
If not booted, boot "HAPPY link LAN" on the PC. LAN is not recognized before HAPPY link LAN is booted.
- ④ Is IP Address in "HAPPY link LAN" set correctly?  
Set up the IP Address correctly based on the "HAPPY Link LAN" manual.
- ⑤ Are PC network settings set correctly? Set up the PC network settings correctly based on the "HAPPY Link LAN" manual.
- ⑥ The wireless connection indicator will light up even if the wrong network key is used.  
Check if correct net work key is entered.

16. Press **OK**.



17. Press **OK**.

The machine will be rebooted and show Drive mode in the display.



18. Press **Next**.

Wireless LAN indicator is displayed if wireless LAN is set up correctly.

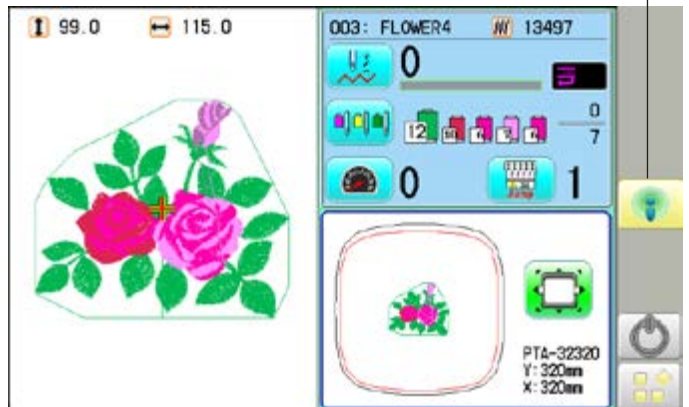
Network communication is not made if wireless LAN indicator is not displayed.  
Check wireless LAN settings.

The machine is automatically connected with "HAPPY link LAN" booted on the PC.

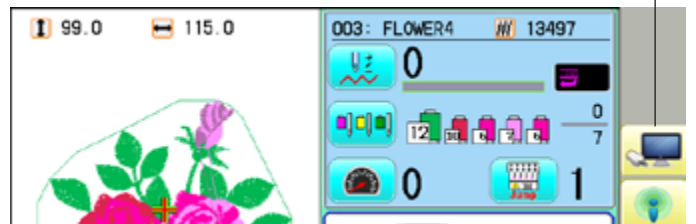
Then, LAN connection indicator is displayed.

Refer to the following cause and counter measures if LAN connection indicator is not displayed.

Wireless LAN indicator



LAN connection indicator



## Causes and countermeasures

- ① Is IP address overlapped on the machine with other machine that creates LAN connection?
- ② LAN cable is connected between the embroidery machine and the PC.  
Remove LAN cable from the machine once and create wireless LAN connection settings.
- ③ "HAPPY link LAN" is not booted.  
If not booted, boot "HAPPY link LAN" on the PC. LAN is not recognized before HAPPY link LAN is booted.
- ④ Is IP Address in "HAPPY link LAN" set correctly?  
Set up the IP Address correctly based on the "HAPPY Link LAN" manual.
- ⑤ Are PC network settings set correctly? Set up the PC network settings correctly based on the "HAPPY Link LAN" manual.
- ⑥ When encryption method is WEP, wireless LAN indicator is displayed with incorrect network key.  
Check if correct network key is entered.
- ⑦ Press **WLAM** at step 13.




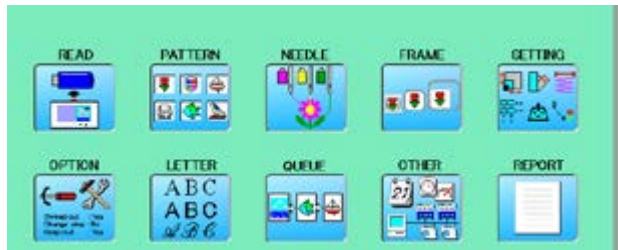
## ● Version information and software update

Software version installed in the machine is displayed.  
Software can be updated to the latest version.

### Preparation for update file

Contact your distributor to obtain the latest update file.  
Use the appropriate update file for your machine.  
Put update file in the root directory of USB flash drive.

1. When the machine is stopped, press .



2. Select "OTHER".



3. Press .

The version of each program is displayed.


1. Main Program (Control Box)
2. Linux Kernel (OS)
3. Machine Control
4. Frame Drive Data



4. Confirm version number.

Press  to return to MENU screen.

The display returns to MENU.

When updating, insert USB flash drive including update file into the controller and press .



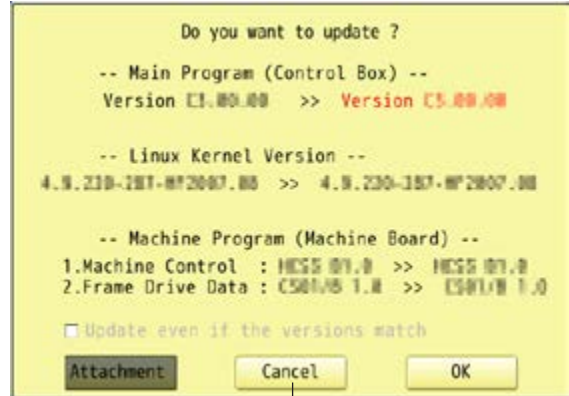
5. Select the file "UPDATE\*\*\*.IMG".

When the version of each program and the version in the update file are different, the version number is displayed in red.

**Update even if the version match**


(OFF) : Only different versions of the program will be updated.

(On) : All programs will be rewritten even if the version number is the same.(Up to 16 minutes)

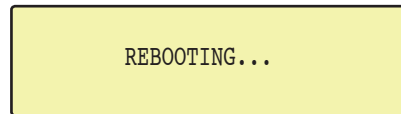


Update is cancelled.


6. Press .

 (Start/Stop button) lights in blue and Update is started.  
Do not turn on power during updating.

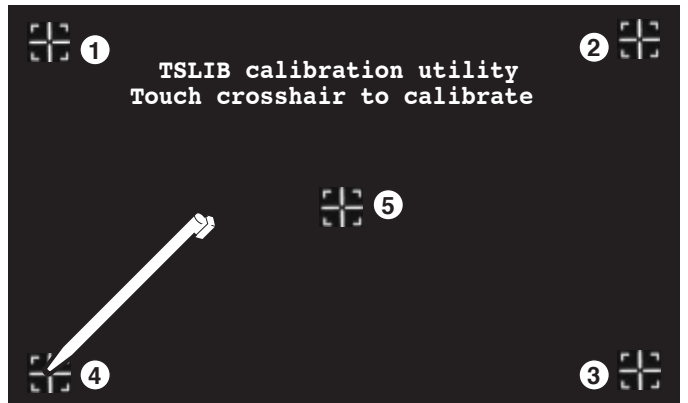
If the Linux Kernel is not updated in step 5, the touch panel LCD is not calibrated. "REBOOTING..." will change to the appeared in step 8 and the update will be completed.



It may take up to about 15 minutes for the display on the right to appear. Prepare built-in stylus.

7. Press the center of  displayed in screen in numerical order by a stylus.

 will appear in numerical order.




8. Press the 5th  by stylus.

The update is complete and the machine will restart.



## ● Language

Change the language displayed on control box.

1. When the machine is stopped, press  .



2. Select “OTHER”.

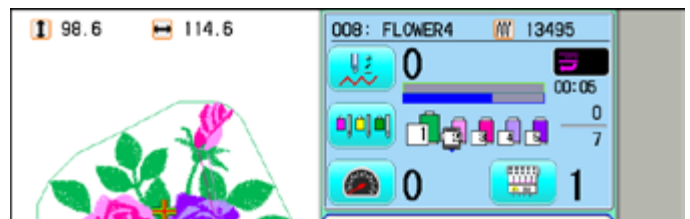


3. Press  Language .



4. Select the Language.

The language has been changed, and the display returns to Drive mode.




## ● Calibrate

Calibration for the touch panel LCD.

Touch panel is already adjusted and you do not need adjustment of the panel.

If the screen does not recognize correct position of each icon and you cannot operate, please adjust the screen as follows:

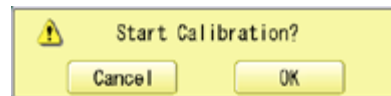
1. When the machine is stopped, press .



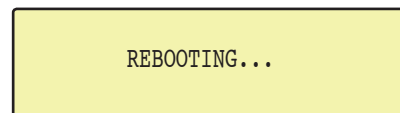
2. Select "OTHER".



3. Press  Calibrate.





4. Press .

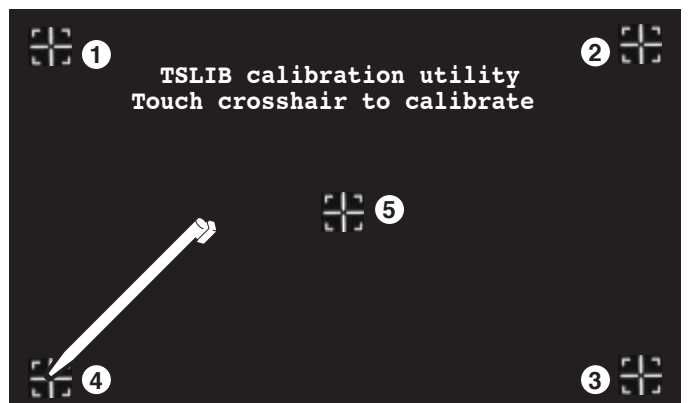


Prepare built-in stylus.



5. Press the center of  displayed in screen in numerical order by a stylus.

 will appear in numerical order.



6. Press the 5th  by stylus.

Adjustment is complete and startup screen is appeared.



7. Press .

After the carriage and frame move slightly, the embroidery frame will return to the previous position automatically.  
The display will return to Drive mode.

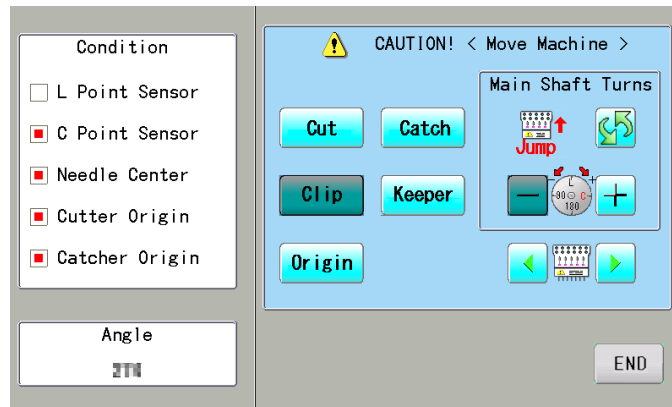


**CAUTION: To prevent accidents.**

The embroidery frame and carriage will move.  
Please keep hands clear for your safety.

## ● User maintenance mode

User maintenance mode has 7 items as below. Indicates point which sensors are active.





Key	Machine movement
Change jump	Change the needle bar's movement. "JUMP" : Needle Jump, "DRIVE" : Needle Drive
Upper shaft turns	Upper shaft turns clockwise and counterclockwise. When release key, upper shaft stops. ⚠ Caution: please be careful that Needle move at once.
Needle change	Move the sewing head to the adjustment needle in the direction of the arrows.
Cutter Open/Close	When cutter is open position, cutter move to close position. When cutter is close position, cutter move to open position. ⚠ Caution: please be careful that cutter move at once.
Catcher Open/Close	When catcher is open position, cutter move to close position. When catcher is close position, cutter move to open position.
Keeper	When keeper is open position, keeper move to close position. When keeper is close position, keeper move to open position.
Standby position	In case, each equipment position without standby position, as example "Upper shaft is not at C point, Thread cut blade is not at stop position, Thread Catcher is open position", this key work for back to standby position automatically.

## Conditions

- L point sensor                      The point that indicator becomes RED is L-point, when upper shaft is turned.
- C point sensor                      The point that indicator becomes RED is C-point, when upper shaft is turned.
- Needle sensor                      The point that indicator becomes RED is needle position, when moving head is moved.
- Origin point of cutter              The point that indicator becomes RED is origin point of cutter.
- Origin point of thread catcher    The point that indicator becomes RED is origin point of thread catcher.

## Angle

Indicate angle of upper shaft.  
In addition, directly enter the angle when you press , the upper shaft can be turned to any angle.  
Please use dial when you need to know precision angle.

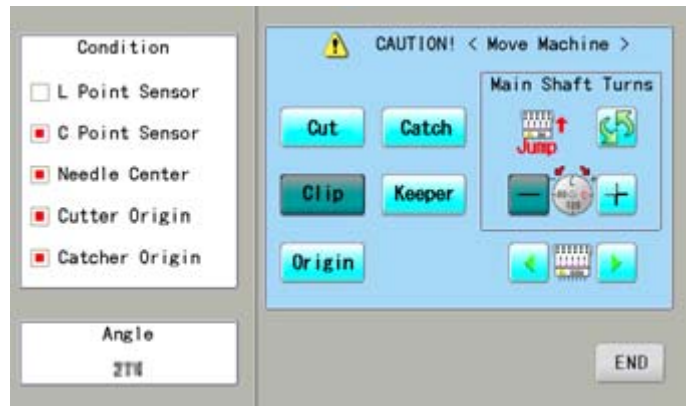
1. When the machine is stopped, press .




2. Press  "OTHER".



3. Press .




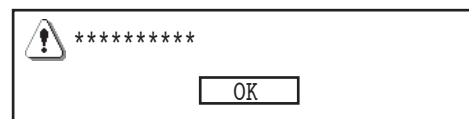
4. Press one key and check machine movement.

 **CAUTION: To prevent accidents;**  
The machine moves quickly.  
Keep hands away from the machine.

One equipment was not standby position, machine show following message when you press key.

- C point : Upper shaft is not at C point.
- Cut blade : Thread cut blade is not at standby position.
- Thread Catcher : Thread Catcher is open position.

Please press  for back to standby position and repeat step 4 again.




Press  to return to Menu mode.

Indicating operation record of machine.

## ●Production data

Last 10 records of following production data will be displayed.  
 Time of power on/off, and number of operated stitches will be recorded in machine memory.  
 If the machine is switched on without embroidery operation, it will not be recorded in memory.

[Power ON]                                   he time when machine main switch is turned on  
 [Power OFF]                                The time when machine main switch is turned off  
 [Embroidery Stitches]                 The number of embroidered stiches while main switch is turned on

1. When the machine is stopped, press .



2. Select "REPORT".

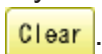


3. Select .

Time of power on month/day/year/                                   Time of power off (1st raw is time of                                   Number


4. In order to exit the mode, proceed to the step 5.

If you want to delete the record, press



No.	Power ON - Power OFF	Stitches
1	12/19/2013/14:08:24 - 12/19/2013/14:13:02	0
2	12/11/2013/11:29:46 - 12/11/2013/14:09:34	62159
3	12/09/2013/11:45:32 - 12/09/2013/12:00:00	163
4	11/28/2013/12:49:33 - 11/28/2013/15:48:10	20702
5	11/28/2013/09:09:19 - 11/28/2013/11:59:10	35253
6	11/26/2013/10:45:54 - 11/26/2013/20:05:10	142105
7	11/15/2013/09:49:32 - 11/15/2013/19:06:33	3253
8	11/15/2013/09:27:10 - 11/15/2013/09:48:54	22
9	11/13/2013/12:53:37 - 11/13/2013/20:36:38	26908
10	11/12/2013/09:34:59 - 11/12/2013/09:35:32	160
	07/11/2013/10:30:19 - 12/19/2013/14:13:02	634560

Time of deleting                                   Current time (time of viewing the                                   Number of stitches after

5. Press .


The display returns to MENU.

Press  to return to Drive mode.



Save the report

You can save the displayed records in CSV format.

Insert the USB flash drive into the machine and press  key then, new folder named "Production Report" will be made and the report data will be saved as file name "Stitch Report\_\*\*\*\*\*".



## ● Detailed production data

You can view following detailed production data for each user. (Max 4,096 data)

### ITEMS

[No.]	Number	: Sequence number of the records
[User] *1	User ID	: The ID number of embroidery machine operator
	User Name	: The name of embroidery machine operator
[Design]	Design ID	: The ID number of embroidery design
	Design Name	: The name of embroidery design
[Stiche]	Stitches	: The number of stitches of embroidery design
[Pro.]	Output	: Quantities of production
[TTL.]	Total time (min.)	: The total required time (minutes) to complete the embroidery design
[RUN]	Running time (min.)	: The machine running time to embroider the design
[PAUSE]	Pause time (min.)	: The pause time in the middle of embroidery
[Run %]	Operating rate (%)	: Running time / Total time
[Pro./H]	Productivity	: Quantity of the production per hour
[BRK.]	Number of thread breakage	: The number of thread breakage within one production cycle

\*1 :When machine main switch is operated (On/Off), "Power off <-> on" will be displayed in "User Name" section.

1. When the machine is stopped, press 



2. Select "REPORT".



3. Select 

No.	User	Design	Stitches	Pro.	TTL	RUN	PAUSE	BRK.	Pro./H	BRK.
1	001: HAPPY User1	001: 0001	805	1	2	2	0	0000	24	0
2	001: HAPPY User1	002: 0002	817	1	2	2	0	0000	24	0
3	001: HAPPY User1	003: 0003	753	1	2	2	0	0000	22	0
4	Power Off <-> On		0	0	0	0	1	00	0	0
5	Power Off <-> On		0	0	0	0	1	00	0	0
6	001: HAPPY User1	004: 0004	711	1	2	2	0	0000	26	0
7	001: HAPPY User1	005: 0005	1279	1	3	3	0	0000	17	0
8	002: HAPPY User2	006: 0006	911	1	2	2	0	0000	24	0
9	002: HAPPY User2	007: 0007	1221	1	3	3	0	0000	19	0
10	002: HAPPY User2	008: 0008	929	1	2	2	0	0000	22	0
11	002: HAPPY User2	009: 0009	1206	1	3	3	0	0000	18	0
12	003: HAPPY User3	010: 0010	1034	1	2	2	0	0000	20	0
13	Power Off <-> On		0	0	0	0	1	00	0	0
14	003: HAPPY User3	012: 0012	1206	1	3	3	0	0000	16	0
15	003: HAPPY User3	015: 0015	1247	1	12	3	10	190	4	0
16	004: HAPPY User4	022: 0022	948	1	3	3	0	0000	18	0
17	Power Off <-> On		0	0	0	0	1	00	0	0
18	005: HAPPY User5	031: 0031	1522	1	3	3	0	0000	15	0
19	005: HAPPY User5	032: 0032	1446	1	3	3	0	0000	16	0
20	005: HAPPY User5	033: 0033	1104	1	3	3	0	0000	19	0

4. In order to exit the mode, proceed to the step 5.

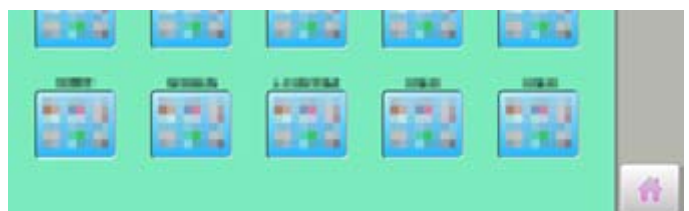
If you want to delete the record, press



4. Press 

The display returns to MENU.


Press  to return to Drive mode.





## Save the report

You can save the displayed records in CSV format.

Insert the USB flash drive into the machine and press  key then, new folder named "ProductionReport" and "RunningLog" will be made and the following files will be saved.

### ProductionReport (Holder)

"ProductionReport-Standard\_\*\*\*\*\*" : This file contains the output data in each piece of embroidery production.

"ProductionReport-Arranged\_\*\*\*\*\*" : This file contains the output data which is totalized in user and design.

"ProductionReport-Arranged2\_\*\*\*\*\*" : This file contains the output data in each day of running ratio.

### RunningLog (Holder)

"RunLog\_\*\*\*\*\*" : The monthly report of running time per hour of each day.  
This report is remained after 13 months.

### ITEMS

[No.]	: Sequence number of the records
[User ID]	: The ID number of embroidery machine operator
[User Name]*1	: The name of embroidery machine operator
[Machine Name] *2	: The embroidery machine name of embroidery design
[Design ID]	: The ID number of embroidery design
[Design Name]	: The name of embroidery design
[Stitches]	: The number of stitches of embroidery design
[Output]	: Quantities of production
[Start of Design] *2	: The time embroidery is started
[End of Design] *2	: The time embroidery is completed
[Total time (min.)]	: The total required time (minutes) to complete the embroidery design
[Run (min.)]	: The machine running time to embroider the design
[Pause (min.)]	: The pause time in the middle of embroidery
[Power OFF] *2	: The time main switch is turned off
[Power ON] *2	: The time main switch is turned on
[Power OFF time] *2	: The elapsed time while main switch is turned off.
[Run Ratio]	: Running time / Total time
[Pause Ratio] *2	: Pause time / Total time
[Productivity/hour]	: Quantity of the production per hour
[Thread Break]	: The number of thread breakage within one production cycle
[Error] *2	: The number of error message within one production cycle
[Interval (min.)] *2	: The time period from machine power on till start of embroidery or the time after completion of embroidery until it starts the next embroidery.

\*1 :When machine main switch is operated (On/Off), "Power off <> on" will be displayed.

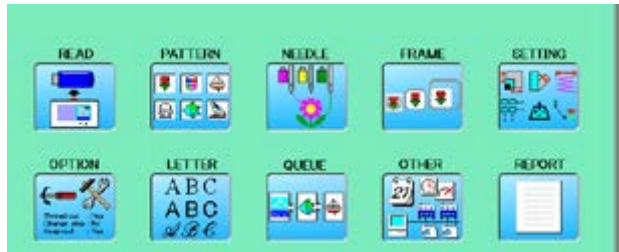
\*2 :These items will not be shown in the display.

## ● Record of thread break

This function will show thread break data of each needles.

In case of Multi-head embroidery machine, data line for each head will be displayed.

1. When the machine is stopped, press .




2. Select "REPORT".



3. Select .

	Head number					Needle number														
Needle	1	2	3	4	5	6	7	8	9	10	11	12	13	14	15	16	17	18	19	20
Head 1	119	0	0	20	0	0	1	8	10	10	10	10	10	10	10	10	10	10	10	10
Head 2	0	0	0	40	0	0	3	1	10	10	10	10	10	10	10	10	10	10	10	10
Total :	299																			

Total

Buttons:  Clear OK

4. In order to exit the mode, proceed to the step 5.

If you want to delete the record, press


 Clear .

4. Press .


The display returns to MENU.

Press  to return to Drive mode.



 Save the report

You can save the displayed records in CSV format.


Insert the USB flash drive into the machine and press  key then, new folder named "Production Report" will be made and the report data will be saved as file name "BreakReport\_\*\*\*\*\*".

## ● The date and time of error message

You can view code and time of the error message and last 100 times of the data will be held.

## ● The number of error message


You can view the total number of each error messages which is occurred in the embroidery machine.

1. When the machine is stopped, press .



2. Select "REPORT".



3. Select .

 The screen is switched to date or number.

No.	Error	Date	No.	Error	Date
1	E-141	2013/12/26 08:37:04	16	E-105	2013/12/17 15:08:08
2	E-116	2013/12/26 08:35:40	17	E-105	2013/12/17 15:08:37
3	E-141	2013/12/24 15:45:23	18	E-105	2013/12/17 14:58:30
4	E-061	2013/12/24 14:09:40	19	E-105	2013/12/17 14:58:19
5	E-141	2013/12/24 12:51:20	20	E-105	2013/12/17 14:58:16
6	E-116	2013/12/24 12:44:33	21	E-105	2013/12/17 14:58:11
7	E-116	2013/12/24 11:37:00	22	E-183	2013/12/7 10:14:41
8	E-116	2013/12/24 11:36:55	23	E-183	2013/12/7 10:14:36
9	E-116	2013/12/24 11:36:50	24	E-183	2013/12/7 10:14:31
10	E-116	2013/12/24 11:36:45	25	E-183	2013/12/7 10:14:26
11	E-116	2013/12/24 11:36:40	26	E-183	2013/12/7 10:14:21
12	E-116	2013/12/24 11:36:35	27	E-183	2013/12/7 10:14:16
13	E-116	2013/12/24 11:36:30	28	E-183	2013/12/7 10:14:11
14	E-183	2013/12/19 15:28:55	29	E-183	2013/12/ 6 10:41:44
15	E-183	2013/12/19 15:15:21	30	E-061	2013/12/ 5 12:56:29

4. In order to exit the mode, proceed to the step 5.

If you want to delete the record, press

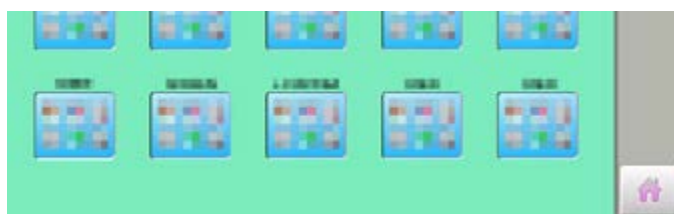
 .

Error Count	Error Count	Error Count	Error Count	Error Count					
E-000	0	E-015	0	E-030	0	E-045	0	E-060	1
E-001	0	E-016	0	E-031	0	E-046	0	E-061	20
E-002	0	E-017	0	E-032	0	E-047	0	E-062	0
E-003	0	E-018	2	E-033	0	E-048	0	E-063	0
E-004	0	E-019	0	E-034	0	E-049	0	E-064	0
E-005	0	E-020	0	E-035	0	E-050	0	E-065	0
E-006	0	E-021	0	E-036	0	E-051	0	E-066	0
E-007	0	E-022	0	E-037	0	E-052	0	E-067	0
E-008	0	E-023	0	E-038	0	E-053	0	E-068	0
E-009	0	E-024	0	E-039	0	E-054	0	E-069	0
E-010	0	E-025	0	E-040	0	E-055	0	E-070	0
E-011	0	E-026	0	E-041	0	E-056	0	E-071	0
E-012	0	E-027	0	E-042	0	E-057	0	E-072	0
E-013	0	E-028	0	E-043	0	E-058	0	E-073	0
E-014	0	E-029	0	E-044	0	E-059	0	E-074	0

5. Press .

The display returns to MENU.

Press  to return to Drive mode.




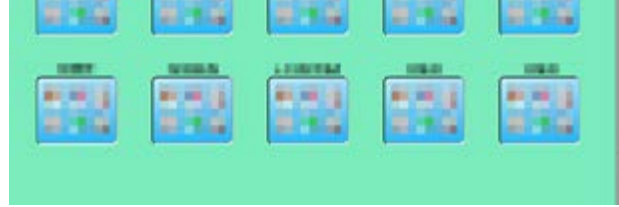
 Save the report

You can save the displayed records in CSV format.

Insert the USB flash drive into the machine, Insert the USB flash drive into the machine and press key then, new folder named "Production Report" will be made and the following files will be saved.

The GUIDE offers tips and step-by-step help for embroidering with the machine. In each stage of embroidery operation there is an easy to follow guide available.

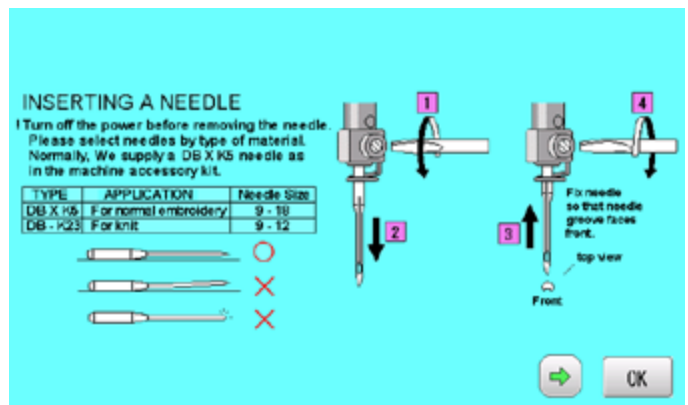
1. When the machine is stopped, press .



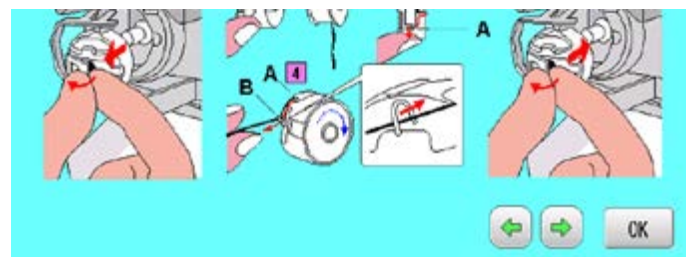
2. Select  "GUIDE".



3. Select desired item.




4. You can move to next page by pressing



5. Press .

You will return to the guide menu.



Press  to return to Menu mode.

If screen saver is set, images saved in the machine are displayed on the screen in numerical order when the machine is stopped and is not in operation for a certain amount of time. Screen saver is cancelled when any place on the touch screen is touched.

■ If the setting time of “display off timer” on “OPTION” is shorter than one of screen saver, screen saver is not displayed.

Make sure the setting time of “display off timer” is longer than one of screen saver when both screen saver and “display off timer” are used. 15-1b

## Start-up time

Set the time to start screen saver

1. When the machine is stopped, press .



2. Select “SCREEN”.



3. Press .



4. Select the number. (Unit : minute)

Changing is cancelled.  
 Numbers are deleted.



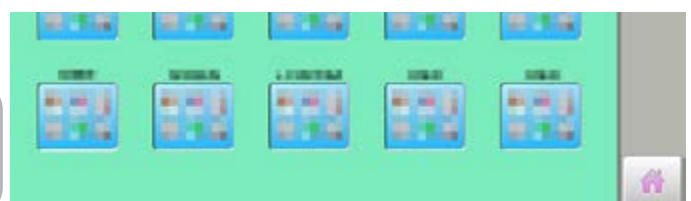
5. Press .



6. Press .

The setting is fixed and display returns to MENU.


Press to return to Drive mode.



## Change and delete image(s)

This is done to change or delete screen saver image(s) 5 images are pre-installed in 001 thru 005.

Maximum 12 images can be saved by adding images.

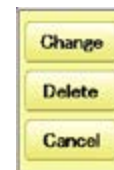
1. When an image is changed, insert the USB flash drive into the machine.
2. When the machine is stopped, press .





2. Select  "SCREEN".



4. Select the image to be unwanted or deleted saved on the screen.



3. Press .

-  Image is deleted.
-  Setting is cancelled.



4. Select Image file.  
Press the image file name you would like to add on the screen.

Ex: The new image is added in the 006.



5. Press .


The setting is fixed and display returns to MENU.

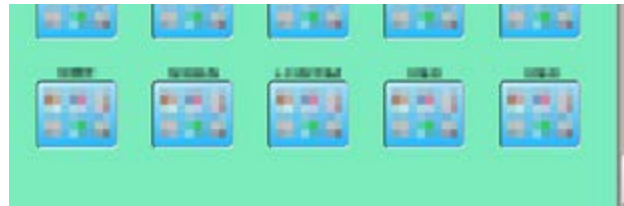
Press  to return to Drive mode.




## Initialization of registered images in the machine

Screen saver images to set current status to initial status (factory setting).  
 Original images in 001 to 005 are restored although they are deleted.  
 All the images saved in 006 to 012 are deleted.

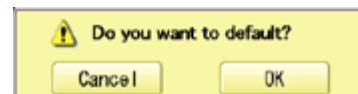
1. When the machine is stopped, press .




2. Select  "SCREEN".



3. Press .



4. Press .


 Initialization is cancelled.



5. Press .

The setting is fixed and display returns to MENU.

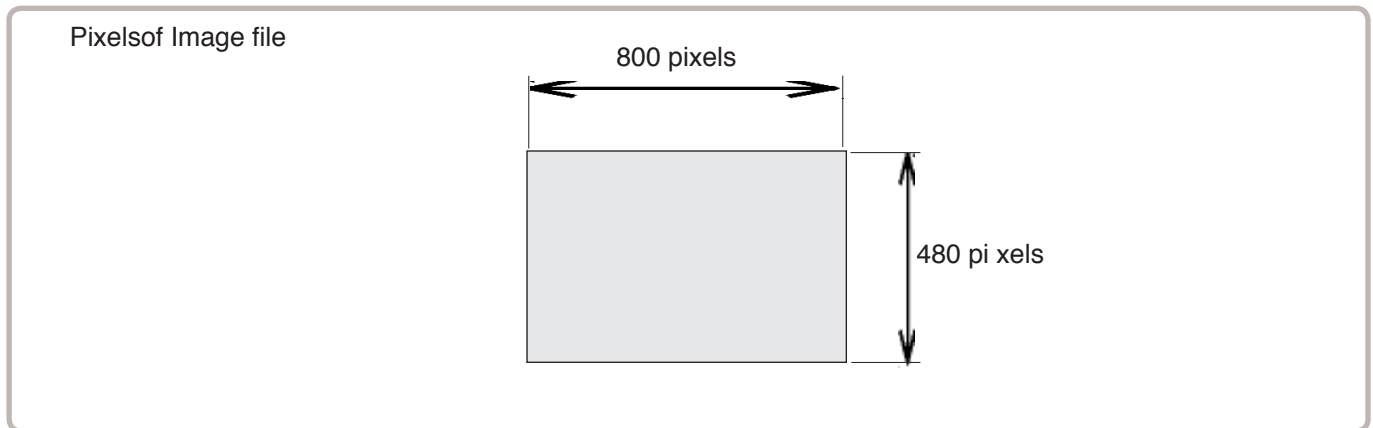


Press  to return to Drive mode.



## How to make the screen saver image

You can display any image(s) in addition to pre-installed images.  
Create image(s) to meet the following specifications by using your image editing software.  
Save the image(s) in USB flash memory.



## File format

BMP format

Ex : "\*\*\*\*\*.bmp"

## Pixels

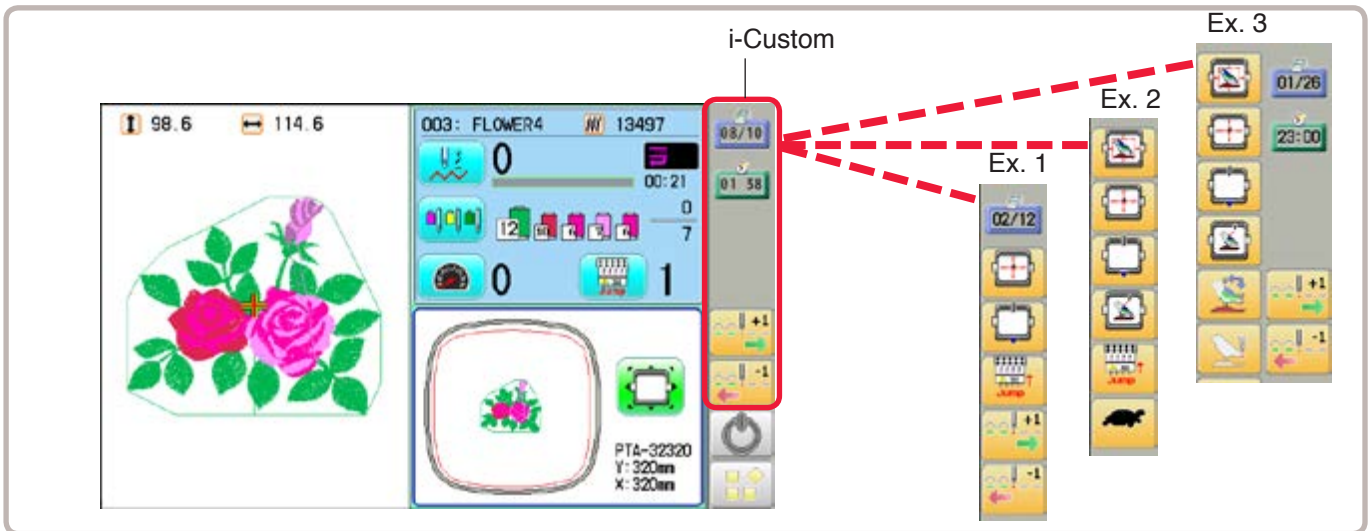
800 x 480 is recommended.

1600 x 1200 can be displayed. However, capacity of the file is larger and the machine consumes the memory for pattern data.


## The number of color


Maximum 24 bits color (full color)


You can place frequently used icons freely on the right side of Drive mode screen.




## Display icons to be placed



 **Calendar**  
Current year, month date is displayed.


 **Clock**  
Current time is displayed.


 **LAN connection**  
This indicates the machine connects with LAN. By pressing this icon, you can retrieve embroidery design from connected PC and load the design to the machine. [P 22-2a](#)


 **Wireless connection (Option)**  
This indicates the machine recognizes wireless LAN device.


## Function icons to be placed


  **Stitch number forward**  
Move the frame forward or backward by the one stitch. [P 3-6](#)

 **Design centering**  
Move design to the center of frame.


 **Center**  
Moves the embroidery frame to the center automatically.

 **Frame out** [P 15-2](#)  
Move frame to the front position which was set before.

 **Original point return** [P 3-6](#)  
This returns the frame to \*pattern origin point.

 **Origin registration**  
Register the current frame position as origin.

 **Trace**  
When pressed while at the beginning of design, the embroidery frame moves following the outer edge of the design.

 **Register**  
Register will restore the position of the frame to the last point before a power failure even if the point of origin or the pattern itself were changed.

**Pointer (Option)**

Turn on and off the laser pointer.

**Jump**

Turn on and off the Jump. 3-5

**Low speed operation 3-5**

Turn on and off the Low speed operation.

**Position alignment by defining 2 points**

Embroidery position is aligned by defining 2 points. 9-8

**Convert 9-5**

Rotate and mirror invert selected pattern data.

**Width adjustment**

This setting adjusts stitch width. 14-3

**Preset (Offset)**

This select the Offset position. 14-A

**Read USB**

Read embroidery data from USB flash drive.

**Read PC**

Read embroidery data from PC.

**Task reservation 22-2b**

It is possible to perform reading design and other operations even while machine is embroidering.

**Bobbin thread alarm**

Alarm message will be displayed when the remaining amount of bobbin thread becomes low.  
 9-Cb

**Work save**

Save working design or read working design.  
 9-Ce

**Stitch number forward ten**

Move the frame forward or backward by ten stitches step

In addition, “Key lock” function can be used by setting. 15-2


When the key is pressed continuously, the “Key lock” function is activated and the frame will move continuously even the finger is released from the key.

When you stop it, press (Start/Stop button).

**Searching pattern data**

Searching of the pattern data stored in the machine memory is available.

11-D

1. When the machine is stopped, press .



2. Select  "i-CUSTOM".




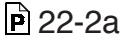



3. Select a desired custom icon.



4. Select display or key icon(s) from the gray frame.  
When changing to other display or key icon(s),




When you select the desired display or key, repeat steps 3 and 4.

-  To change the number of icons to display.
-  22-2a
-  To change to the page of i-CUSTOM.
-  To delete delete a selected i-CUSTOM.
-  Setting is returned to the default.

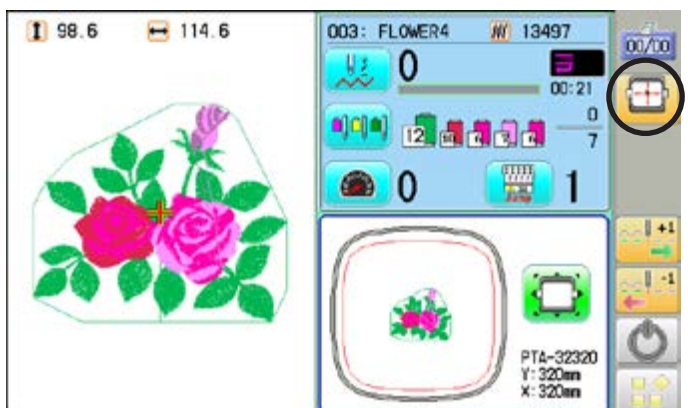


The desired key change has been made.

5. Press .  
The setting is fixed and to return to Menu mode.



6. Press .  
Custom icon change is made.




## Change the number of icons

i-CUSTOM capacity will be expanded from 6 to 14 icons.  
It returns to capacity of 6 by pressing this selection key again.



1. Press  .

The number of placement icon will increase.  
Return to the previous number of icons when  
press  .

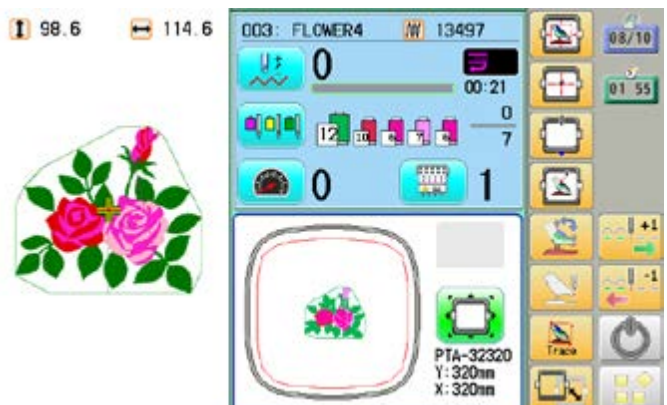


2. Press  .



3. Press  .

It increases the number of icons to be displayed  
on the Drive mode.





### LAN connection

This indicates the machine connects with LAN.  
 Design folder settings on the "Happy Link LAN" is required before reading pattern data.  
 Please refer to "Happy Link LAN" System INSTRUCTION MANUAL regarding the settings method.  
 The pattern data can be read through the designated folder and sub-folders.

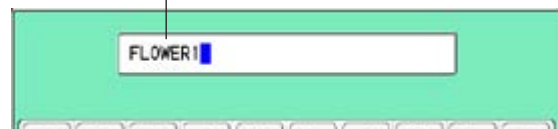
- The retrieval function will not work when same pattern name is saved in selected folder and sub-folder.

### Barcode reader

Barcode reader from third parties which is connected to USB port of the control box (Standard-A receptacle) can also be used for retrieving design name.  
 The barcode reader should be set to add code "CR+LF" at end of the data.  
 Please refer to instruction manual of the barcode reader for setting and operation.











1. Press .

Currently selected pattern name is displayed.



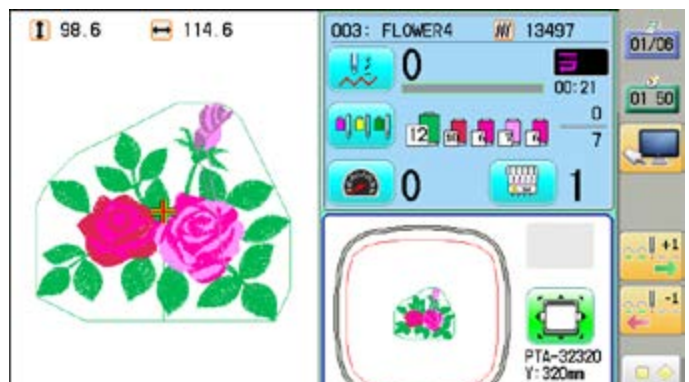
2. Enter the pattern name.  
 The maximum number of characters in a design name is 24 letters or numbers.  
 For correct retrieval, all characters need to match exactly.  
 Normally, extension name is not required when the pattern name is displayed correctly.



-   The cursor moves left and right.
-   The screen is switched.
-   Enter the extension.
-  All the letters are deleted.
-  The letter is deleted before the cursor position.
-  The screen returns to drive mode.
-  Read retrieved pattern from PC.

3. Press .

Machine return to Drive mode.



This function allows you to perform following operations even while machine is embroidering. After the task reservation, it is also possible to reserve the pattern to the embroidery sequence list. (max. 30 patterns)

By this reserve function, the embroidery patterns can be changed sequentially in accordance with the list.

The below confirmation message will be shown before changing the patterns.



Reading : This reads pattern data and writes into memory. 22-2d



Needle bar selection : A needle number can be assigned to a color change number of pattern data. 22-2e



Setting : Settings such as the scaling, repeat sewing, offset and frame out can be applied to a pattern data. 22-2f



Search : Search and read embroidery patterns which are saved in the PC connected through LAN. 22-2g



List : Open the embroidery sequence list to access the patterns.


Also some editing functions are available such as delete, sort and copy. 22-2h



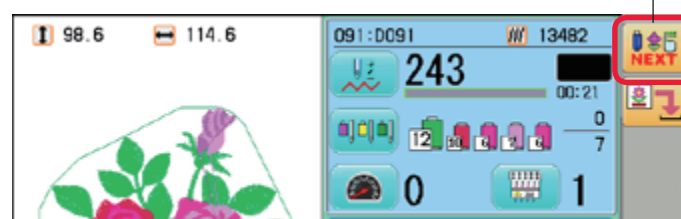
Letter : You can create monogramming data by using built-in alphabet, numbers and symbols. 22-2i



Layout : Combined pattern data can be made by putting pattern(s) and letter(s) anywhere you like on the layout window. 22-A

Please note that the Task reservation function is only available when the  Task reservation icon is placed on the drive mode screen with using i-CUSTOM beforehand. 22-1

Icon of "Task reservation"



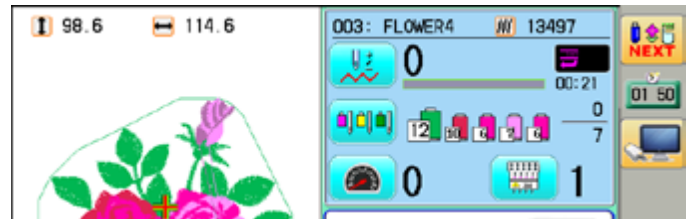


## Reading

This reads pattern data and writes into memory.

There are some icons (displayed in gray) which can't be used through the function.

However, the basic operation is same as "reading" function from main menu. 5-6

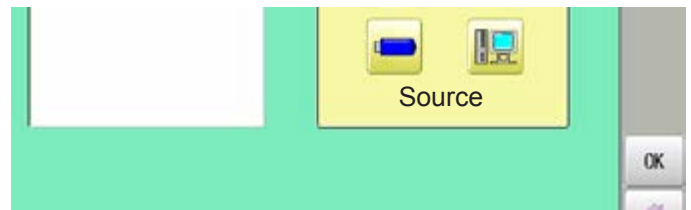


Task reservation menu

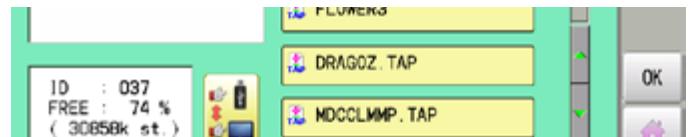


1. Press "TASK RESERVATION".

2. Press "READ".



3. Select [USB] or [PC] from Source window.



4. Select pattern for reading pattern data.



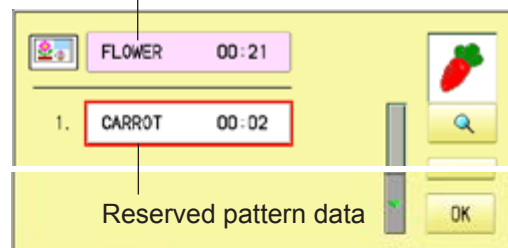
5. Press .



6. Press or .

Selected or embroidering pattern

The pattern will be reserved in the embroidery list.



The pattern will not be reserved.  
The display go to the view of Step 7.

7. Press .

Enable to read other pattern data.  
If you wish to read another design, to read other design from Step 4.

Sub-menu



8. Press (Sub-mnu).

Machine return to Task reservation menu.

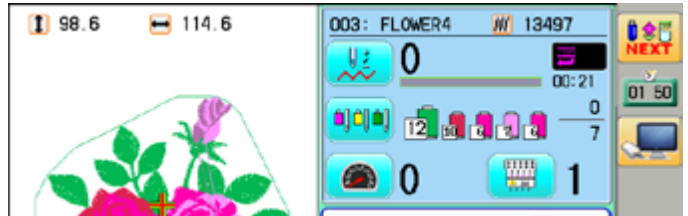




## Needle bar selection

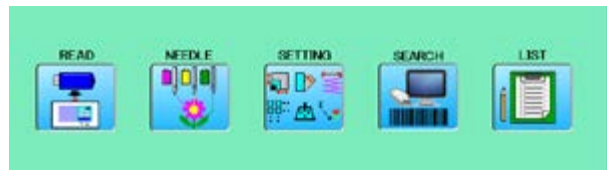
A needle number can be assigned to a color change number of pattern data. There are some icons (displayed in gray) which can't be used through the function. However, the basic operation is same as "reading" function from main menu. 5-E

1. Press "TASK RESERVATION".



Task reservation menu

2. Press "NEEDLE".



3. Select pattern data, then press (Sub-mnu).

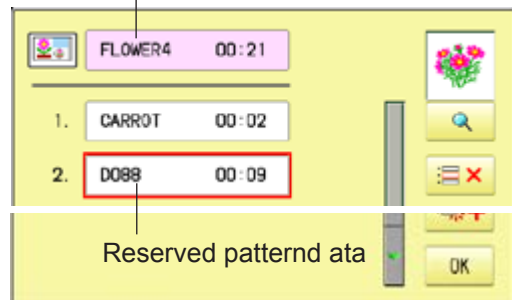


4. Press or .

Selected or embroidering pattern

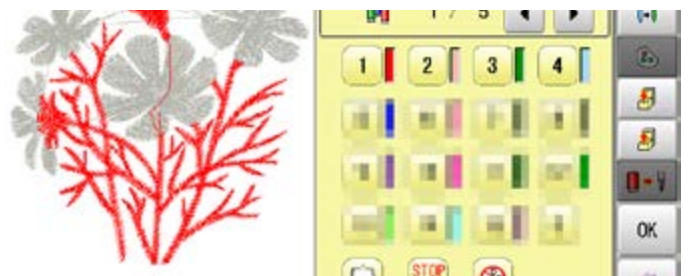
The pattern will be reserved in the embroidery list.

The pattern will not be reserved. The display go to the view of Step 5.



5. Press .

6. Perform Needle bar selection, then press (Sub-mnu).



Machine return to Task reservation menu.

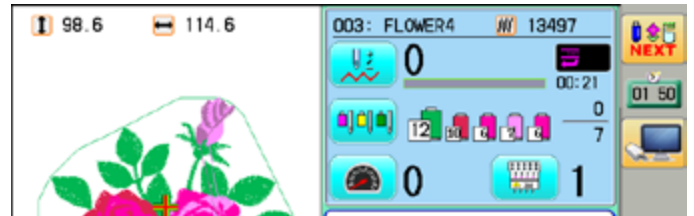


## Setting

Settings such as the scaling, repeat sewing, offset and frame out can be applied to a pattern data.

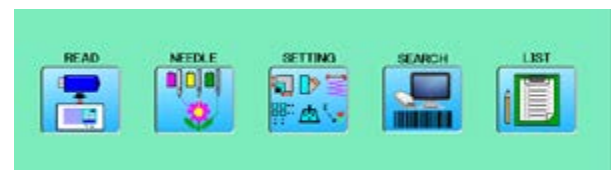
There are some icons (displayed in gray) which can't be used through the function.

However, the basic operation is same as "reading" function from main menu. 14-1



Task reservation menu

1. Press "TASK RESERVATION".



2. Press "SETTING".



Sub-menu

3. Select pattern data, then press

(Sub-mnu).

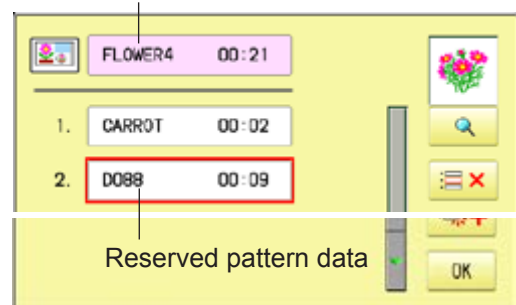


Selected or embroidering pattern

4. Press or .

The pattern will be reserved in the embroidery list.

The pattern will not be reserved.  
The display go to the view of Step 5.



Reserved pattern data

5. Press .

6. Perform Pattern setting, then press (Sub-mnu).

Machine return to Task reservation menu.

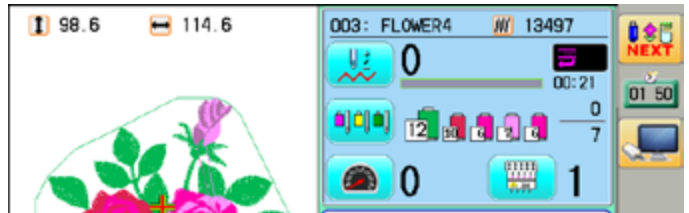




## Search

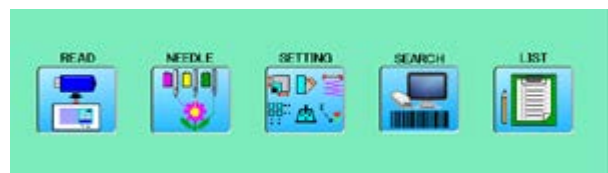
Design folder settings on the "Happy Link LAN" is required before reading pattern data. The basic operation is same as "LAN connection" function. [P 22-2b](#)

1. Press  "TASK RESERVATION".

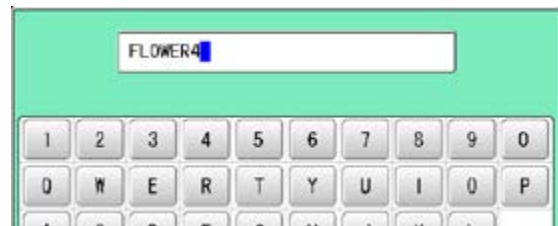


Task reservation menu

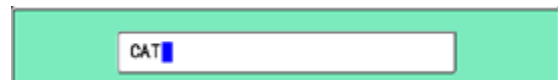
2. Press  "SEARCH".




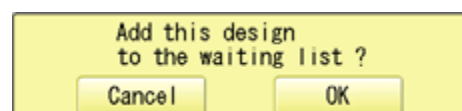
3. Enter the pattern name.





4. Press .



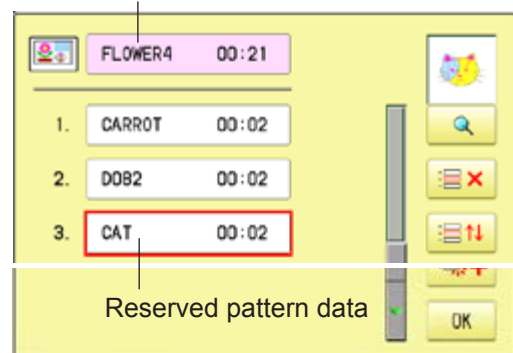
5. Press  or .



 The pattern will be reserved in the embroidery list.

 The pattern will not be reserved. Machine return to Task reservation menu.

Selected or embroidering pattern



6. Press .

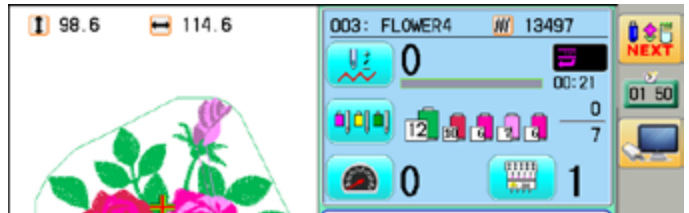
Machine return to Task reservation menu.



## List

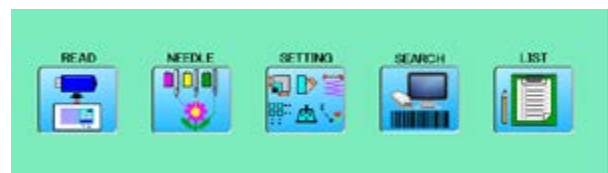
Open the embroidery sequence list to access the patterns.

Also some editing functions are available such as delete, sort and copy.



Task reservation menu

1. Press  "TASK RESERVATION".



2. Press  "LIST".

You can see embroidery list.

3. Edit the reservations when it is needed



Display the selected pattern on the screen.



Delete the selected pattern reservation. By doing long press of the icon, all reservations will be deleted.



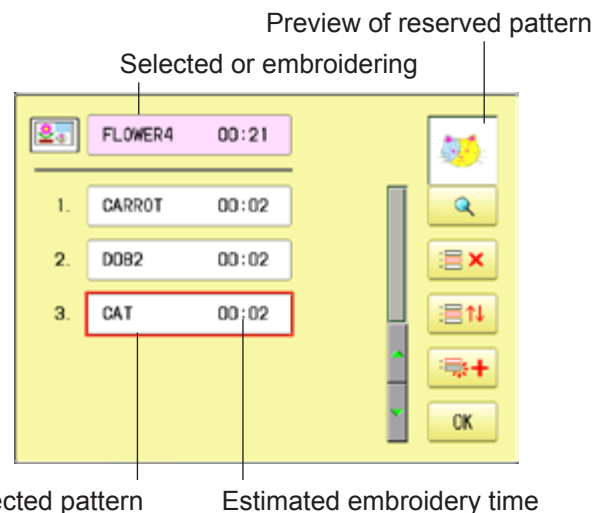
Move the selected reservation to desired position

< ◀ icons will be displayed between the reservations.

Press < ◀ icon at desired position.



Make a copy of the selected pattern and insert it at next position of the original. This function can be used to make same embroidery once more



4. Press  .

Machine return to Task reservation menu.


## Letter

You can create monogramming data by using built-in alphabet, numbers and symbols. [P 22-2i](#)  
 The basic operation is same as “Letter” function from main menu. [P 16-1](#)

1. Press  “TASK RESERVATION”.


2. Press  “Letter”.


3. Select letter.

4. Press  when you are finished with the letter selection.

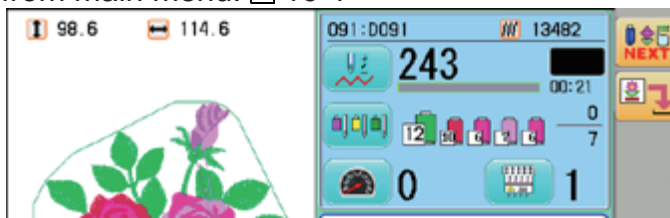
5. Select the font.  
 Set the various functions if necessary.

6. Press  or .

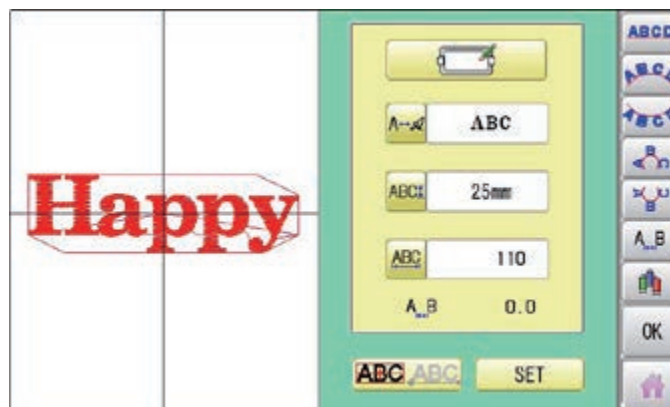
 The pattern data is saved and machine return to Task reservation menu.

 The pattern data is saved and machine return to Drive modeu.

The created pattern data is not reserved in the embroidery list.



Task reservation menu





## Layout

Combined pattern data can be made by putting pattern(s) and letter(s) anywhere you like on the layout window.

The basic operation is same as “Layout” function from main menu. 22-A

1. Press “TASK RESERVATION”.

2. Press .

3. Press “Pattern selection” and select the pattern.

Press “Letter selection” and select the letter.

Set the various functions if necessary.

4. Press or .

5. Press .

Select start point of embroidery from 9 preset points which are located around or center of the pattern.

The start point of first selected pattern will be set as the start point of combined design.

6. Press .

Saving pattern name is displayed.

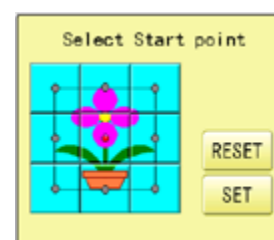
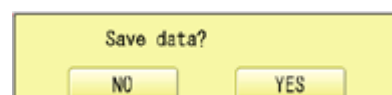
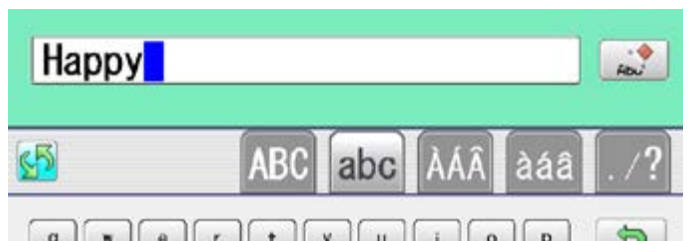
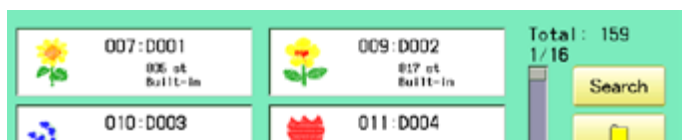
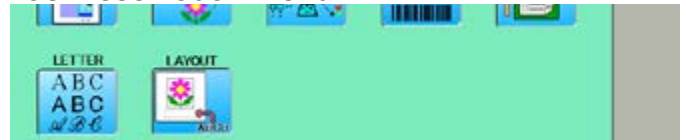
7. Press .

The created pattern is saved and the display return to Drive mode.

The created pattern data is not reserved in the embroidery list.



Task reservation menu




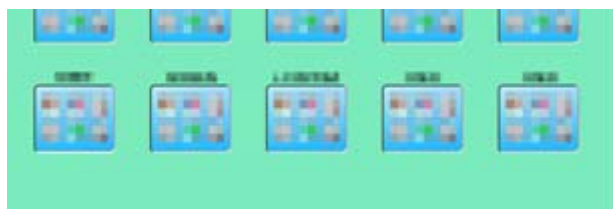
When machine operators have been registered as user, you can manage the right to operate the embroidery machine and you can collect the production data of each user.

## ●Registration of administrator

Registration and change of administrator's name and password.

Only registered administrator has the right to access the user management function.

1. When the machine is stopped, press .

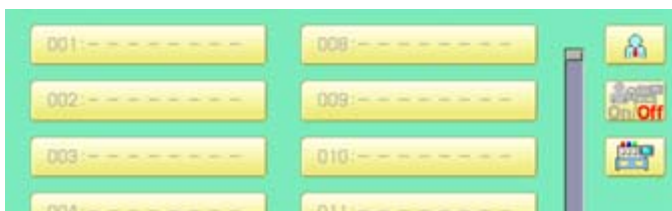



2. Select  "USER".



3. Press .

The display when password is not set.



When administrator's password is set, enter password and press .

The display when password is set.







 Cancelled.

 Numbers are deleted.

4. Press .







5. Press , in case you do not need to change the administrator's name.



When you prefer to change the administrator's name, move cursor with   then, enter new name from the keyboard and press .



The maximum number of characters is 16 letters.

-  Uppercase and lowercase letter are switched.
-  All the letters are deleted.
-  Selected number is deleted.
-  Cancelled.

6. Enter arbitrary 6 digits number as password.  
Enter "000000" if you do not want to use password.  
Please keep your password safe.


-  Cancelled.
-  Numbers are deleted.


**CAUTION**  
If you lost the password, you may not be able to access the User management function.  
Please contact your dealer, if you have forgotten or lost your password.

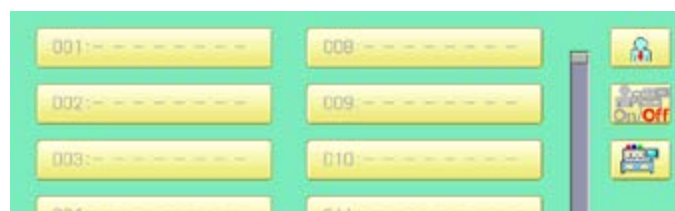


7. Press .

Password is fixed.


8. Push  to activate the User management function.

The icon will be changed to .



Proceed to step 9, if you do not want to use the User management function.



9. Press , when you want to change the machine name.

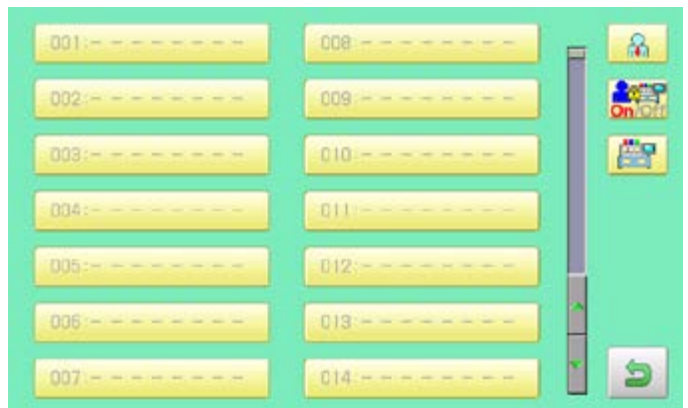



10. Enter new [Machine name] and press



Please note that the [Machine name] will be recorded as an item of the Production data.  
The maximum number of characters is 15 letters.

If the Machine name is not to be changed, proceed to Step 11.




11. Press .

The setting is fixed and to return to Menu mode.



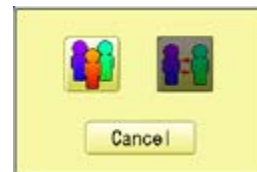
## ●Registration of user

Registration and change of user name and password.  
The maximum 250 user can be registered.

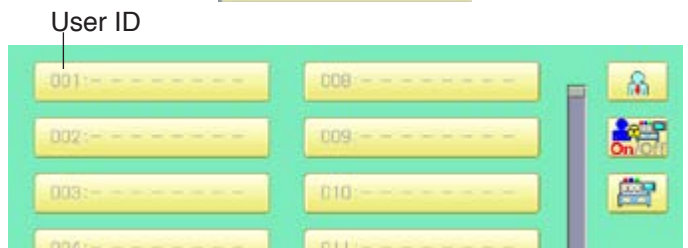
1. When the machine is stopped, press  .



2. Select  “USER”.



3. Press  .



4. Select desired ID number.



5. Enter user name from key board then, press



The maximum number of characters is 16 letters.



Cursor are moved.



Uppercase and lowercase letter are switched.



All the letters are deleted.



Selected number is deleted.



Cancelled.



6. Enter arbitrary 6 digits number as password.

Enter "000000" if you do not want to use password.

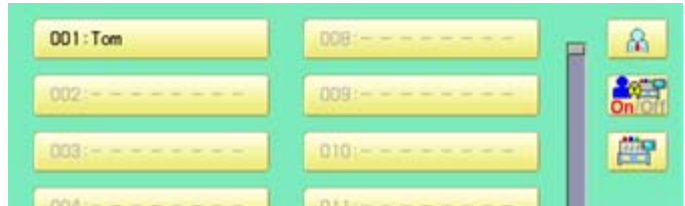
 Cancelled.

 Numbers are deleted.



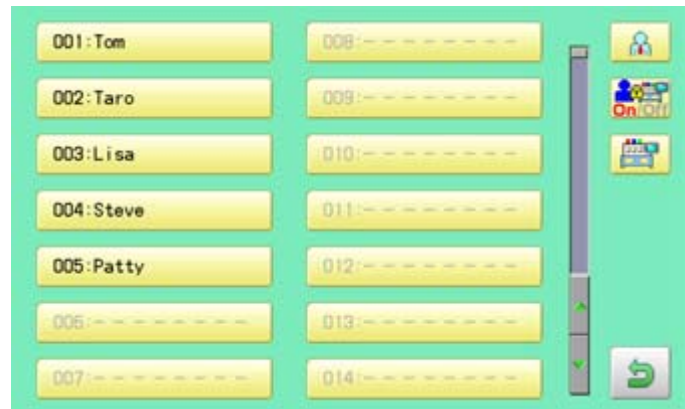
7. Press .

The setting is fixed.



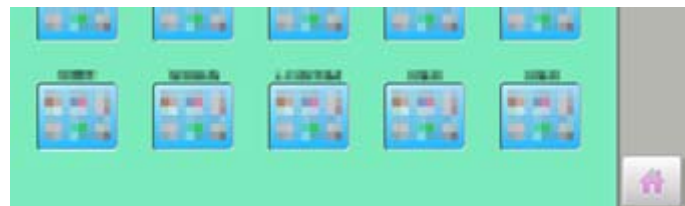
8. To continue registering other user, repeat the procedure from step 4 to 7.

Proceed to step 9, if you do not want to register user name.



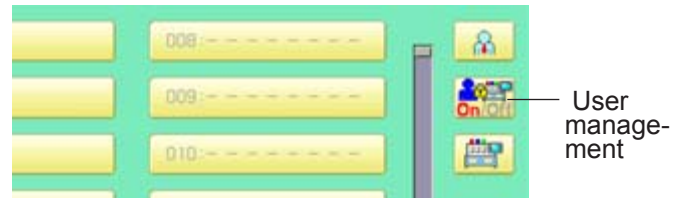
9. Press .


The setting is fixed and to return to Menu mode.



## ● Selection of user (Login)

You can select user name and login, when User management function has been activated beforehand.



1. When the machine is stopped, press .



2. Select  "USER".



3. Press .



4. Select user or administrator

If password has not been set, the screen will be changed as step 6.

5. Enter the password.



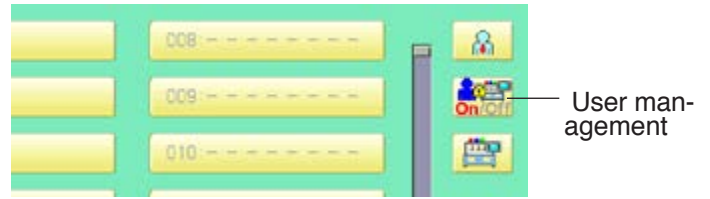
6. Press .

To return to Menu mode.



## ● Selection of user (Login) at power ON

The user selection menu will be displayed, when User management function has been activated beforehand.



1. Turn on the power switch.



2. Press **Next**.

After the carriage and frame move slightly, the embroidery frame will return to the previous position automatically.

**CAUTION: To prevent accidents.**  
The embroidery frame and carriage will move. Please keep hands clear for your safety.



3. Select user or administrator

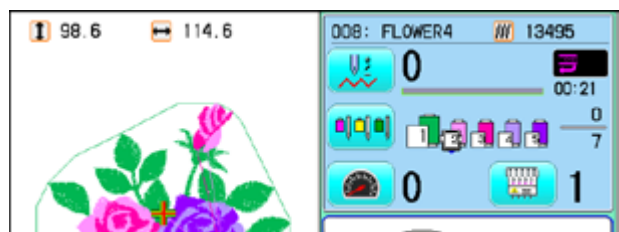
If password has not been set, the screen will be changed as step 5.

4. Enter the password.



5. Press **SET**.

Machine becomes ready for operation.

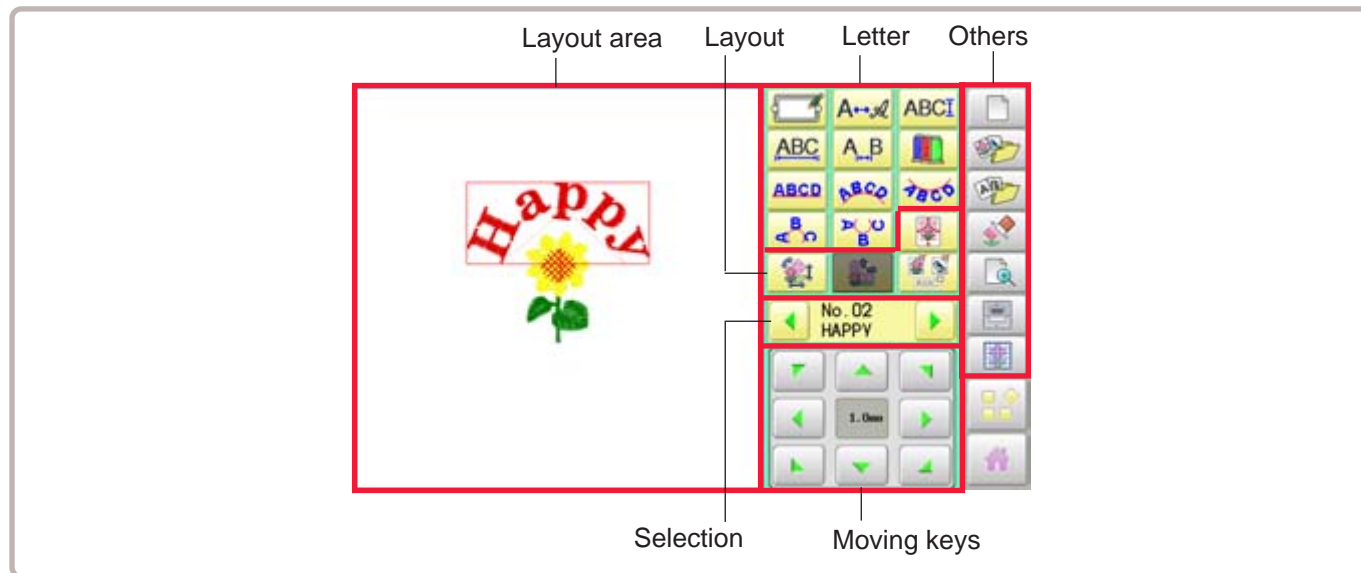


Combined pattern data can be made by putting pattern(s) and letter(s) anywhere you like on the layout window.

The pattern data can be saved to the machine for embroidering.

■ When "PATTERN SETTING" is set on the selected design, these setting will be taken over to the new design.

■ The number of color change function (Color change) for combined pattern data shall not exceed 250.



## Layout area

Display the area for pattern layout



With "Layout area" key, you can change the area for pattern layout.

## Letter



Letters

Changing the Letter.



Font

Changing the font.



Height

Changing the height.



Line length

Changing the line length.



Space [P](#) 16-5

Changing the spacet.



Color change between letters [P](#) 16-6

Color change can be made between letters.



Layout method [P](#) 16-1

Changing the layout method of the letterst.

## Layout



Centering

Move the pattern to center of the Layout area.



Pattern settings [P](#) 14-2 ~ 14-4, 9-5

Various pattern settings such as scaling, width adjustment, rotate angle and convert design.



Repeat [P](#) 14-5

Copy the design as user-specified number in the X and Y directions.

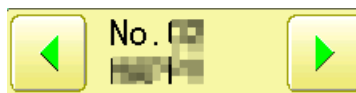
Please note that the repeat function does not work at letter layout.



Multiple patterns movement [P](#) 22-F

Select multiple patterns and move position together.

## Selection



Selecting the pattern.

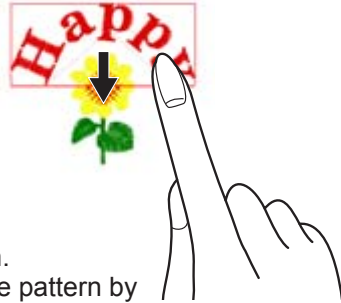
Display selected pattern number (sequence number of layout) and pattern name.

## Moving keys



Move selected pattern.  
You can also move the pattern by pressing desired position on the screen.

With pressing **1.0mm**, you can change the steps of movement to 1.0mm.



## Others



Layout area [P 22-G](#)

Change display area for pattern layout.



Pattern selection

Select desired pattern for layout



Letter selection

Enter desired letters for layout.



Delete

Delete selected pattern (letters)



Zoom [P 22-H](#)

Zoom in and zoom out the pattern layout.  
The selected patterns can be moved with keeping desired scale.



View all

Display whole pattern image when the layout area is set more than 100mm.




Grid [P 22-I](#)

Display grid with desired scale.

This instruction is based on an example in the right drawing.



1. When the machine is stopped, press .



2. Select  "LAYOUT".



## Pattern selection

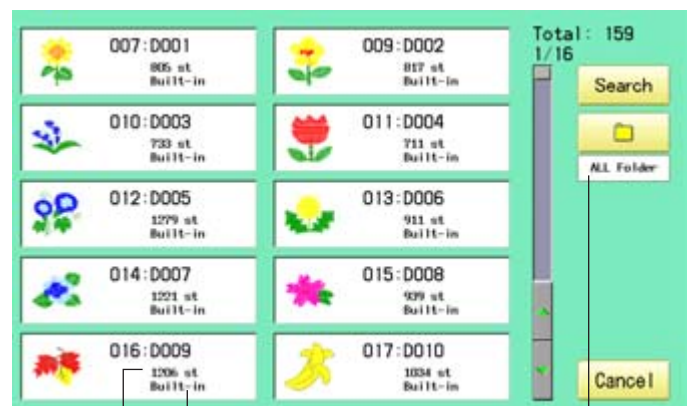
3. Press .

All pattern data stored in the machine memory will be displayed.



Searching the patterns. [P 11-D](#)

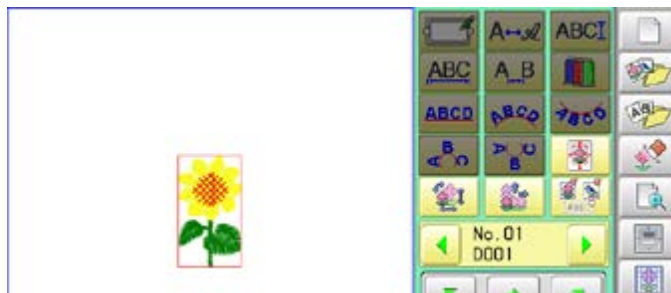
Selecting the folder.



Stitches of pattern

Display the folder name to search  
The folder name which the pattern is saved

4. Select the pattern




## Letter selection

5. Press .



6. Select letter.

Select letters. One data can contain up to 26 letters including space.

 The screen is switched to basic script or cyrillic script.

 All the letters are deleted.

 Basic script



 Diacritic script

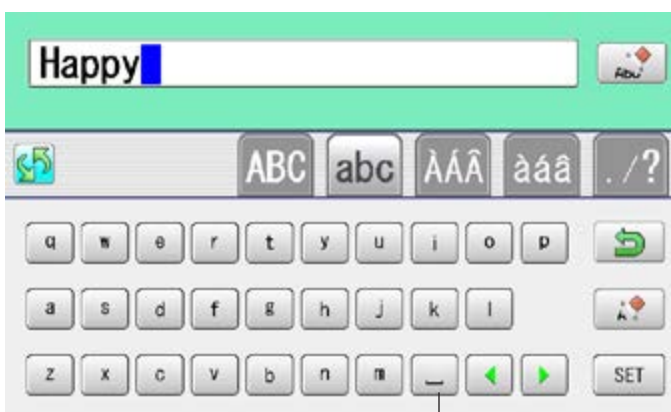
 Cyrillic script

 Symbol

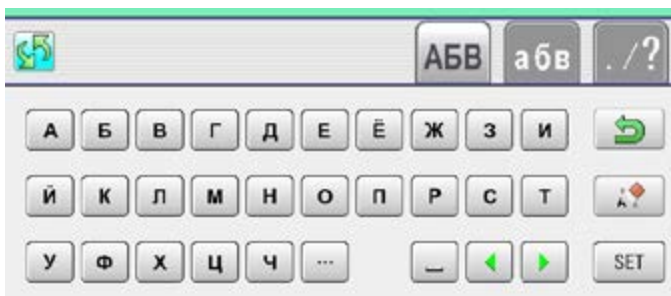
 The screen returns to menu.

 Selected letter or number is deleted.


  The cursor moves left and right.




Space or Delete

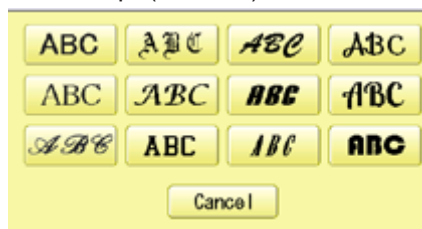


Except for the space between letters, space is eliminated.

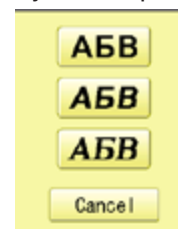
7. Press  when you are finished with the letter selection.

Fix your setting and you can select fonts.  
For fonts, refer to [BUILT-IN FONT LIST].  26-3

Basic script (Diacritic)



Cyrillic script



## Font Selection

8. Select the font.

Basic script (Diacritic)

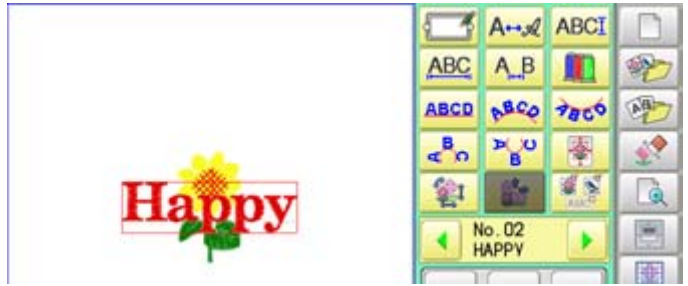


Cyrillic script





9. Select desired height.

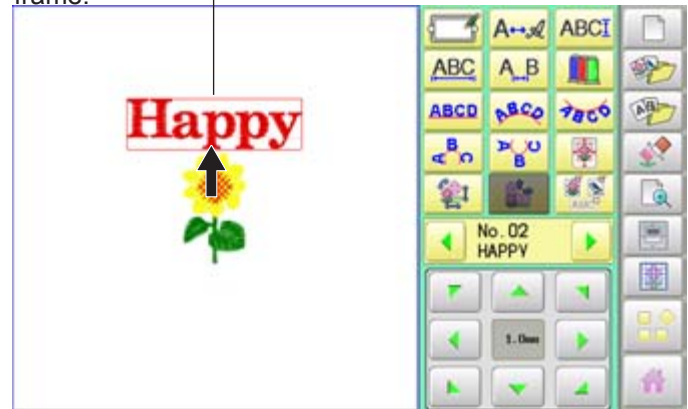


The selected letter (pattern) is displayed with rectangular frame.

10. Move letters with



The selected letters (pattern) can be moved.



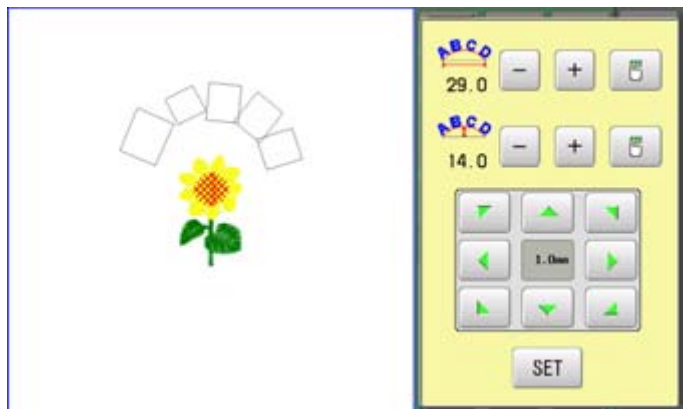
## Layout method

11. Select .

Adjust width and height of arch if necessary.

 16-1

You can move letters with



12. Press .



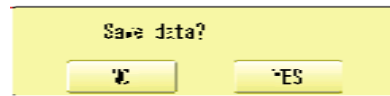
13. Move letters with



## Saving

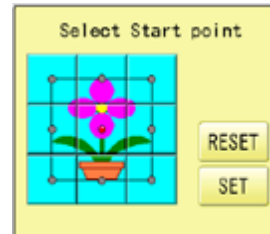
Save the laid pattern data.


14. Press  or .



15. Press .

Select start point of embroidery from 9 preset points which are located around or center of the pattern.



 The start point of first selected pattern will be set as the start point of combined deign.

16. Press .

Saving pattern name is displayed.




17. Go on to next step, if the pattern name is not to be changed.

When you would like to change the letters, select each digit in the existing name with



Then select each digit in the existing name. Select word.

The maximum number of characters in a design name is eight letters or numbers.

 All the letters and/or numbers are deleted.

 Selected letter or number is deleted.

 Renaming is cancelled.

18. Press .

The new design is saved and the display return to Menu mode or Drive mode.





## Multiple patterns selection

Select all or multiple patterns and move the position together.

1. Change pattern with **-** **+**, then press



The desired pattern is selected.  
Make sure that the selected pattern is displayed with rectangular frame.



Switch status between selected and non-selected

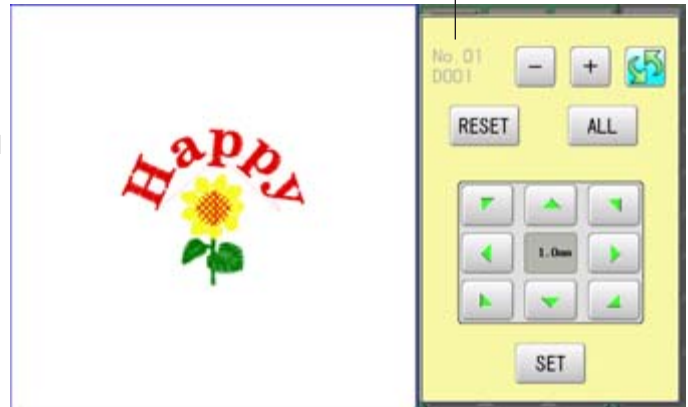


Set all patterns as non-selected.

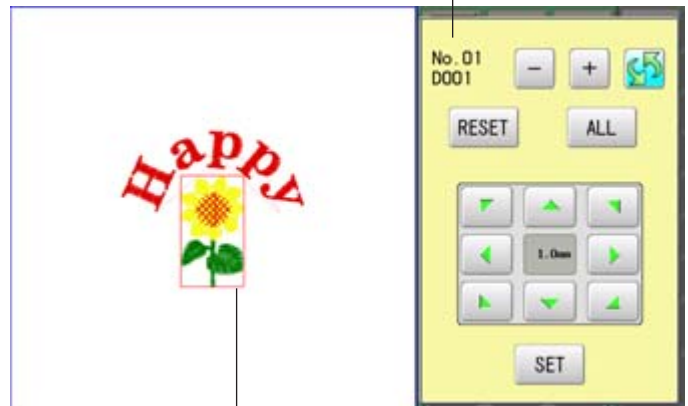


Set all patterns as selected.

Non-selected pattern (gray)



Selected pattern (black)



The selected pattern is displayed with rectangular frame.



An example when all patterns are selected.

2. Move selected pattern with



3. Press **SET**.

Selected pattern will be moved.



## Layout area

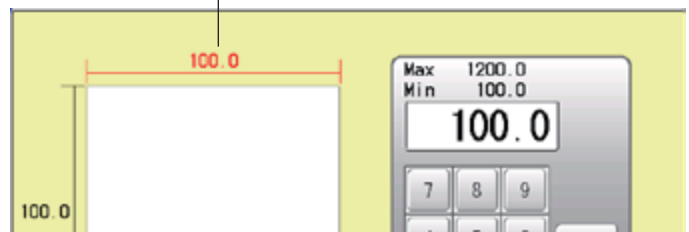
Change the size of layout area.

1. Press .



2. Press , enter X axis distance.

X direction is displayed in red. (It is ready to enter figure)

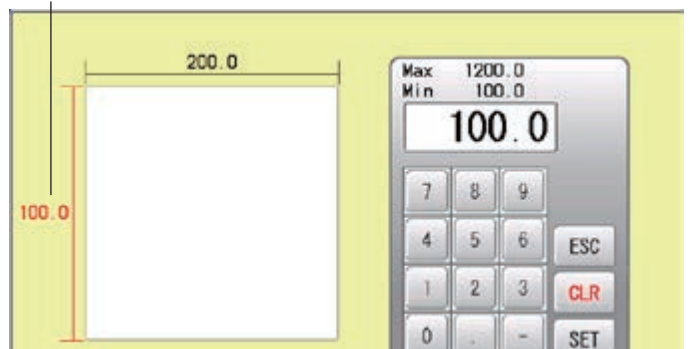


3. Press .

Y direction is displayed in red. (It is ready to enter figure)

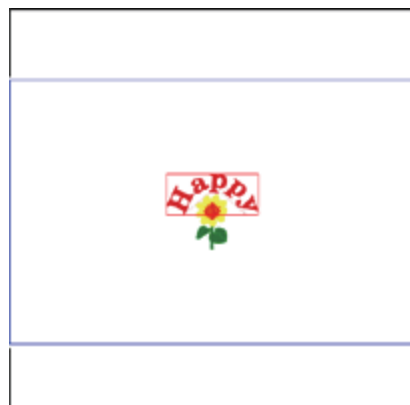
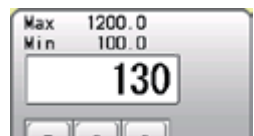


4. Enter Y axis distance.



5. Press .

The size of layout area is changed.



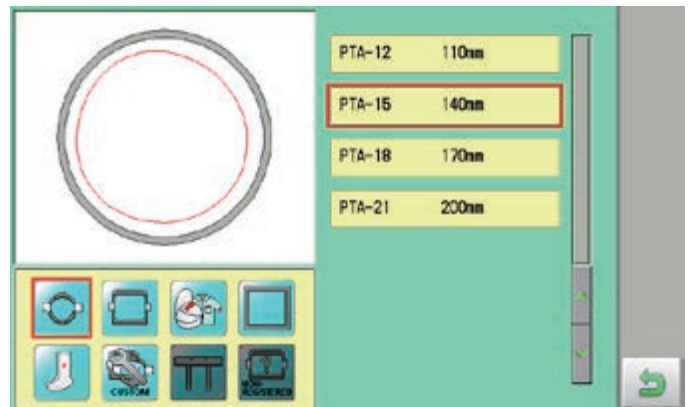
## Frame display

Select and display the frame, in the area where the pattern is placed.

1. Press  .

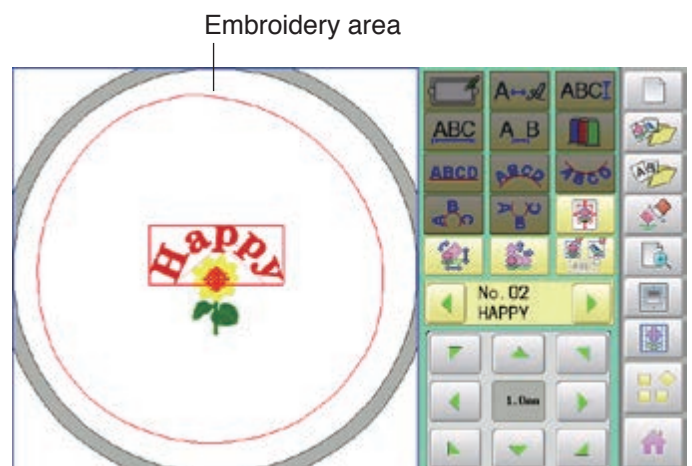


2. Press  .



3. Select type of frame and Press  .

Selected frame will be displayed.

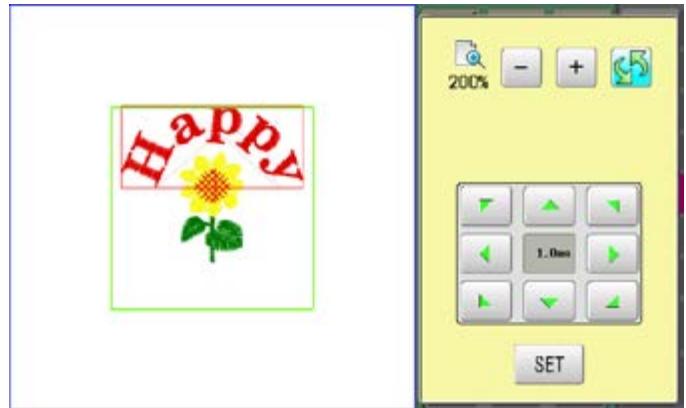






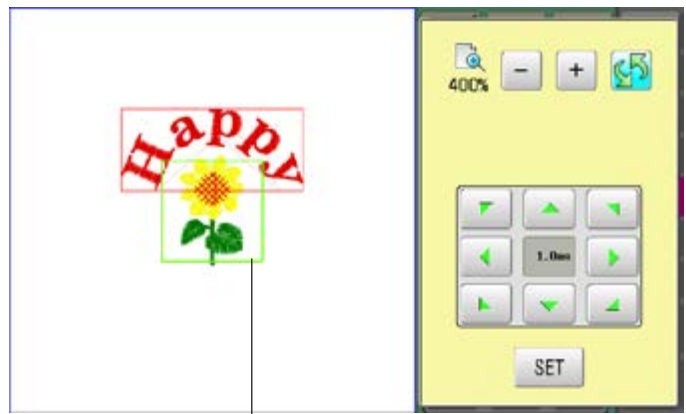
## Zoom

Zoom in and zoom out the display of pattern.

The selected patterns can be moved with keeping desired display scale.



1. Change display scale with  .



2. Press .

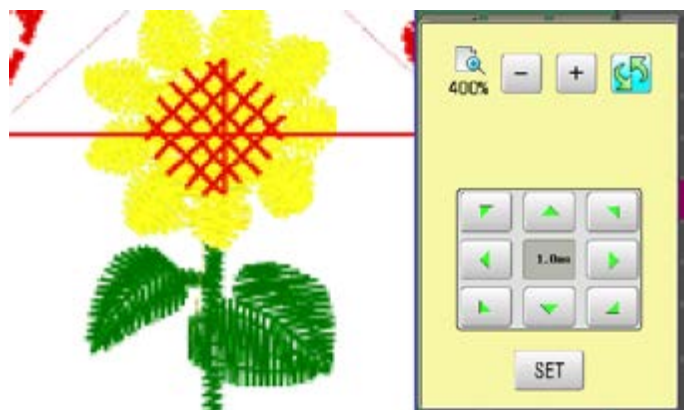
The pattern is displayed with desired scale.



Switch zoom function between on and off.



Move selected pattern.



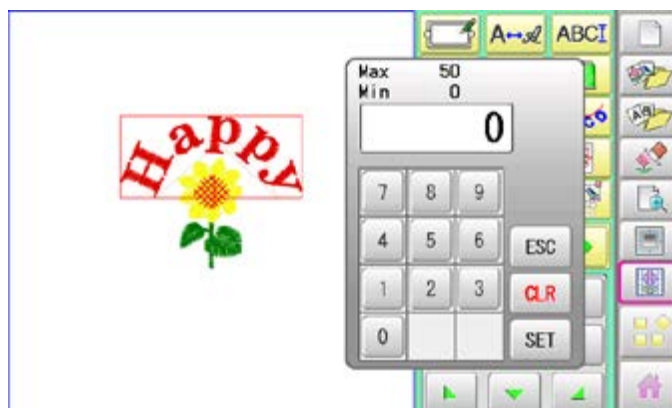
3. Press .

Exit from zoom function.



## Grid

Display grid in the layout area with desired scale.  
 The snap function will work when you move the pattern by finger or stylus.  
 Then, the center of the pattern and cross line of the grid will match automatically.



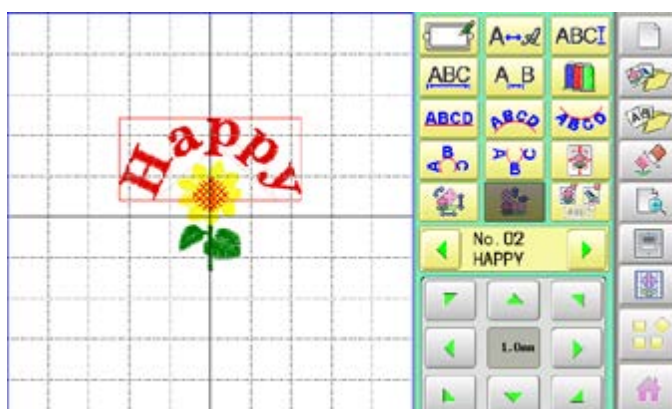
1. Enter size of the grid.



2. Press **SET**.

The grid is displayed.

Enter "0" if you do not use the grid.




This function is used when the embroidery machine and Happy PMS (Production management system) are connected with network.

It is not required to set when the Happy PMS is disconnected. Please refer to instruction book of "Happy PMS" for more precise information.

1. When the machine is stopped, press



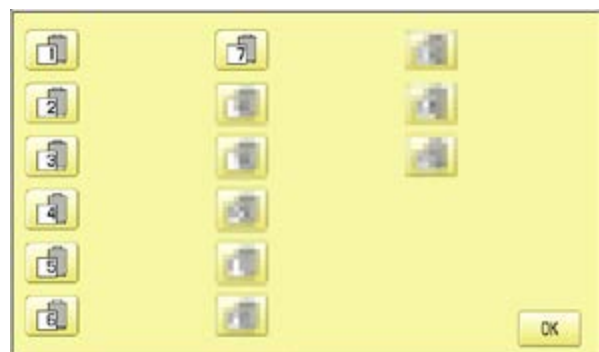
2. Press  when the standard control box.

The page of menu to changed.



3. Select "THREAD SET".

Please refer the instruction manual of "Happy PMS".



4. Press .

Fix your setting and the display returns to MENU.





## ● Specifications

Voltage	1 phase 100V ~ 115V -10% ~ +5%	1 phase 200V ~ 230V -10% ~ +10%
Electricity consumption	220 W	220 W
Frequency	50 / 60Hz	
Short Circuit Rating	200A	
Noise level	Under 72dB(A) (at 0.5m away from needle point)	
Environmental condition	Temperature 0 ~ 40° C Moisture 45 ~ 85 %	
Dimension (Width x Height x Depth)	642 mm x 734 mm x 745 mm, 25.3" x 29" x 29.3"	
Weight	42 kg	
Embroidery area (Y x X)	Tubular frame (Sew field of PTA-32320) 285 mm x 290 mm, 11.2" x 11.4" Max.*1 Normal cap frame (Option) 67 mm x 180 mm, 2.6" x 7" Max.*2 Wide cap frame (Option) 95 mm x 290 mm, 3.7" x 11.4" Max.*2	
Memory capacity	About 100,000,000 stitches	
Registered pattern	3,000 pat.	

\*1 Actual embroidery area will be restricted in accordance with inner frame size.

\*2 Actual embroidery area will be restricted in accordance with shape of a cap.

■ Specifications are subject to change without notice.

## ● Oiling



**CAUTION: To prevent accidents.**

When performing maintenance, be sure to disconnect the power cord.

The machine will periodically prompt periodically for lubrication based on the number of stitches sewn.

When powered on, the machine will display an icon and letter to indicate that lubrication is necessary. 5-3



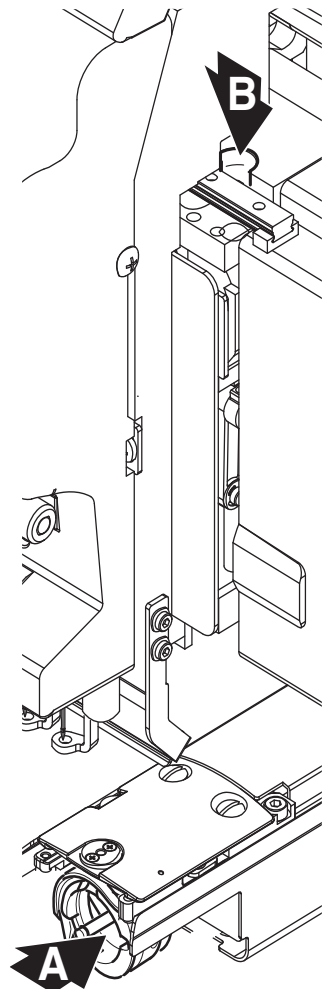
Please lubricate the specified oil locations according to the instructions below.

Running the machine without proper oiling will damage the machine. Lint will gather in and around the rotary hook. Rotary hooks then wear which will cause the threads to break. Please clean lint with a brush and run the machine idly for 2 ~ 3 minutes.

Mark	Place to oil	Specified oil
A	Rotary hook (Lubricate with oil slightly with a small brush and sewing machine oil between the outer and inner rotary hook parts.)	Sewing machine oil
B	Head shaft	

■ When oiling the Head shaft, please move the head to the left by pressing (Pointer). 3-5

■ Too much oil may stain fabrics and threads.





**CAUTION: To prevent accidents.**

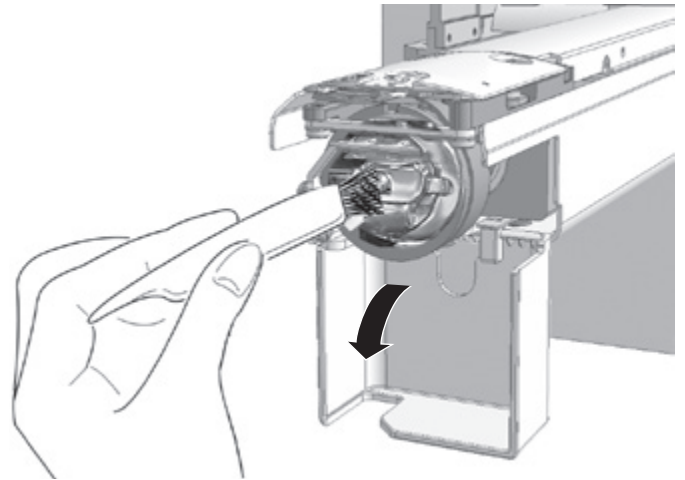
When taking care of the machine, be sure to remove the plug.

## ● Cleaning of the rotary hook

If the rotary hook is clogged with waste thread or dust, it will degrade the stitch quality of the embroidery or may cause other problems.

For a long sewing life, please keep the rotary hook clean.

Use the included brush for cleaning the hook.

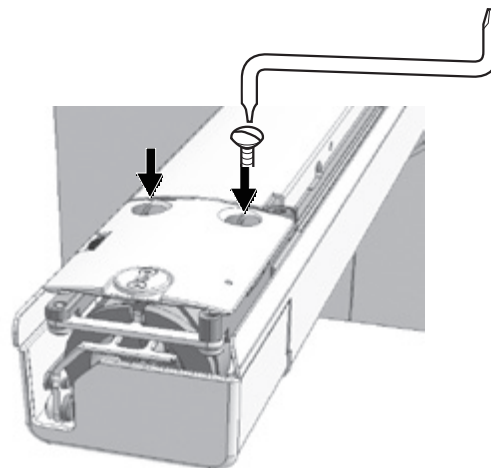



## ● Cleaning the thread cutting knife

If the thread cutting knife is clogged with waste thread or dust, the knife will not work correctly.

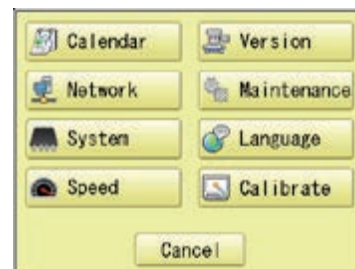
Please keep the thread cutting knife and device clean.

1. Remove set screw (2 pieces) by offset driver and remove the needle plate.

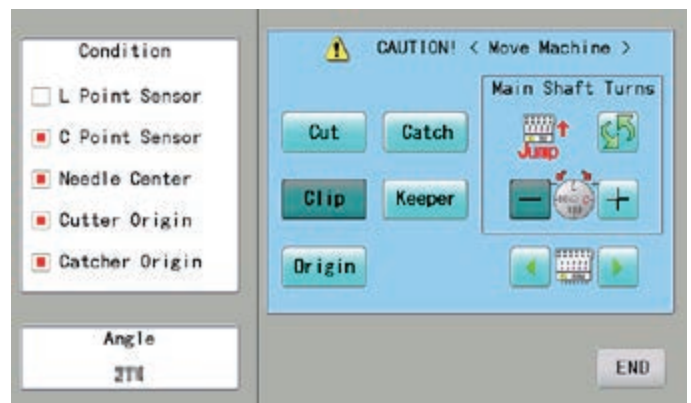


2. When the machine is stopped, press 

and Press  "OTHER".



3. Press .



**CAUTION: To prevent accidents.**  
The thread cutting knife moves quickly.  
Keep your hands away from the machine.

4. Press **Cut**.

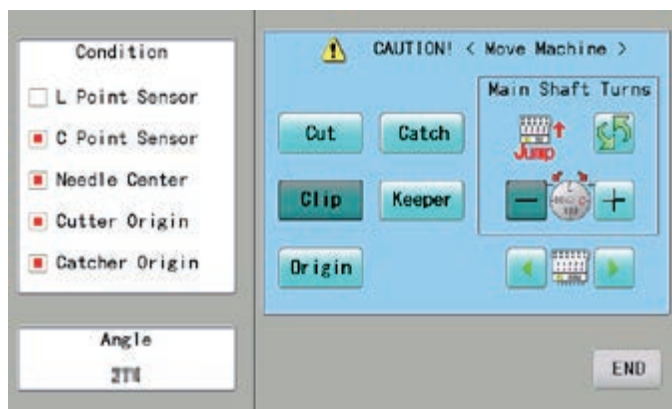
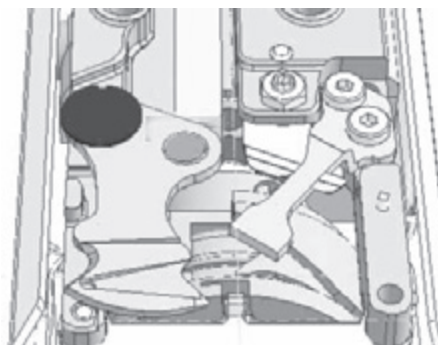
In maintenance mode, pressing this button causes the moving knife to open and stop at max open position.

5. Remove any waste thread and dust from the knife assembly and surrounding area.

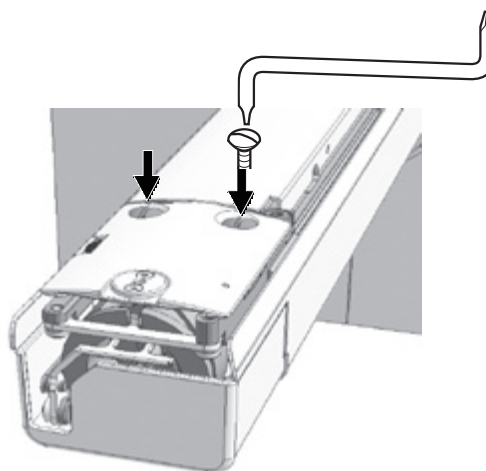
6. Press **Cut**.

Moving knife returns to the original position.

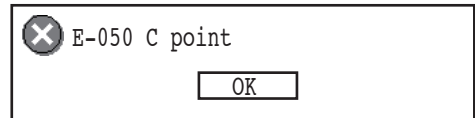
Press **END** to return to Menu mode.



7. Tight set screws (2 pieces) for fix the needle plate.



The machine has an extensive error code list to aid in troubleshooting when problems occur, as listed below. Upon error, press **OK** to release the error and correct it according to the list below.



When errors occur frequently, please contact your dealer.

## Automatic errors backup

The machine recovers from some errors (E-050, E-190, E-193) automatically after detecting the error(s) by it self. In cases where the machine does not recover from the error automatically, follow the "Solutions" below according to the indicated error number.

### CAUTION: To prevent accidents.

In case of "Automatic errors backup", the machine's sudden movement might be caused without showing errors or messages after its stoppage.

No.	Display	Error	Solutions	Page
001	Circuit board	Abnormality detected in control circuit board	Power down machine and, after 10 seconds, power on again.	
002	Power source	Power failure or abnormal voltage		
004	System memory	System memory fault		
015	Inverter trip	Sewing motor-related trouble. Overload, short circuit, trouble with motor drive unit	Cut power and turn main shaft by hand. If turns normally, power on again. Fig. 2	
018	Main shaft	Main shaft will not turn.	Turn main shaft manually at least 1 full turn & ensure that it turns freely, clearing any jam. Then, re-initialize machine system and speed.	25-1 25-2
020	Needle detect	Machine not detecting current needle # correctly, or needle bar selection unit is off its stop position. Trouble with position-detecting circuit board.	Turn needle bar selector to the fixed position (marked area shown below in Fig.1).	
021 022	Needle move	Motor for needle bar selection unit has stopped partway through its path. No movement due to malfunction of thread take-up lever or trouble of position-detecting circuit board	After fixing malfunction of needle and thread take-up lever, turn needle bar selector shaft with wrench to have it set at center of fixed position (range within which needle bar selector doesn't move) Fig. 1	
024	Needle center	Needle bar stop position is off-center; needle bar stop position is out of place.	Turn needle bar selector with 3mm hex wrench to have it set at center of fixed position (scope within which needle bar selector doesn't move). Fig. 1	
025	Needle over	Needle # out of range of actual needles on given machine.		
026	Needle differ	Needle # differs between		

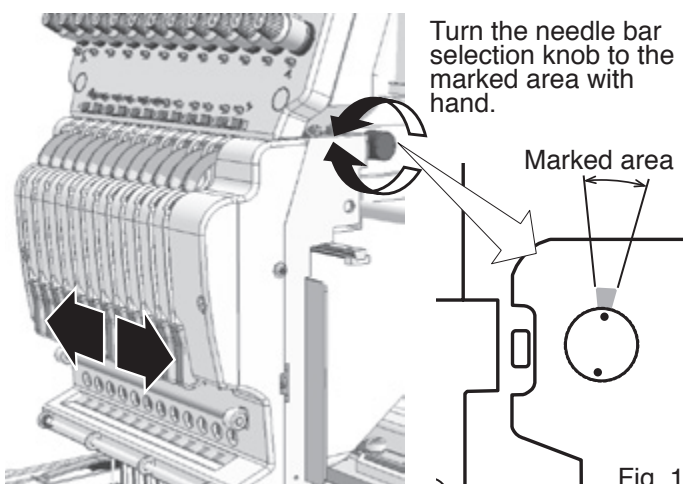


Fig. 1

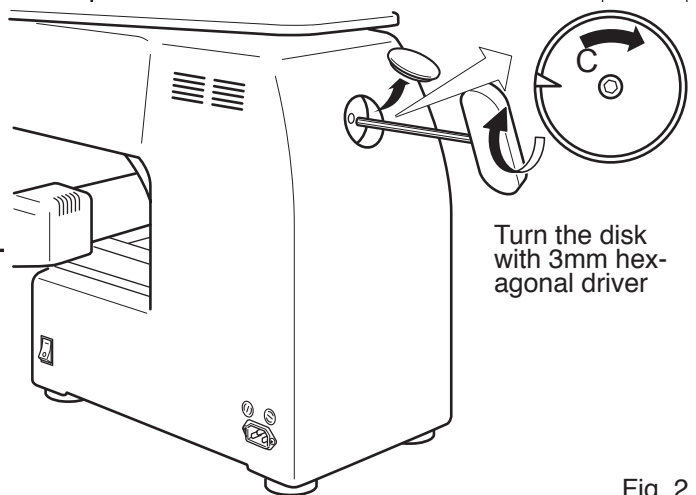


Fig. 2

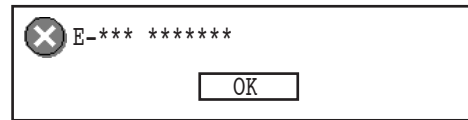
No.	Display	Error	Solutions	Page
030	Slow mismatch	Improper speed adjustment at low speed. Speed does not decrease below 100rpm at low speed.	Re-initialize machine system and speed.	25-1 25-2
050	C point	Main shaft is stopped in a position other than "C" point	Follow the instructions below.	24-4 25-1 25-2
051	L sensor	Timing detection board fault, or marred photo-sensor. Malfunction of "Lowest needle position" sensor [PH2] on detection circuit board. Improper adjustment of slit plate.	Check to see if photo sensor is clean or if the slit plate contacts sensor. Re-initialize machine system and speed.	25-1 25-2
052	C sensor	Timing board detection fault, or marred photo-sensor. Malfunction of "Color change position" sensor [PH1] on timing detection circuit board. Improper adjustment of slit plate.		
055	Take-up cover	bar selection unit is off its stop	Close the take up lever cover.	
060	X limit	Frame/pantograph has moved beyond sewing area along X-axis.	Return frame within sewing area using the frame movement keys on the control boxl.	
061	Y limit	Frame/pantograph has moved beyond sewing area along Y-axis.	Check pattern size and center mark to ensure that it is within size range of selected hoop and also properly centered	
063	Drive Setup	During embroidery, preparation for frame movement did not complete within predetermined time.	Malfunction of "Lowest needle position" sensor on detection circuit board, Improper adjustment. Re-initialize machine speed. If this condition occurs frequently, contact your Dealer.	25-2
066	Frame drive	During embroidery, frame movement did not complete within predetermined moving time.	If this condition occurs frequently, contact your Dealer.	
090	Miss reception	Error has occurred during data transfer (via cable) between machine and PC.	Try reading pattern data again.	5-4
091	No send	Machine has not received data for > 10 seconds during data transfer.		
103	Data format	Machine unable to determine format of pattern data.	Verify format of pattern data and fix if necessary.	10-3
104	Miss function	Timing to read pattern data does not conform.	Read pattern data again from the start.	5-4
105	Dual function	Data has been detected in the pattern that has ambiguous/dual function.	Read pattern data again from the start.	5-4
106	No function	Interval between start read time and time of reception of actual pattern data is too grea.	Check quality of design data.	
108	Improper read	While reading pattern data, error has occurred in internal processing.	Read pattern data again from the start.	5-4
110	Memory full	Memory has filled while reading in a design.	Delete unnecessary patterns from machine memory and try again.	5-B
111	Change over	While reading pattern data, # of color changes (color No.) has exceeded 250.	Divide pattern data such that number of color changes of each segment is less than 250.	
112	Data error	Pattern data of current design is damaged.	Delete pattern and re-load.	5-B
114	Id over	# of patterns in control panel memory has exceeded the maximum of 3000.	Delete unnecessary patterns from machine memory and try again.	5-B
116	Not found Id	Specified pattern does not exist.	Check setting.	
118	Trace data over	Over 1024 stitches trace data were created during reading of pattern data.	Set maximum stitch length to embroidery area of pattern data within 2m (lengthwise) x 2m (sideways).	

# ERRORS AND WHAT TO DO

# 24-3

No.	Display	Error	Solutions	Page
130	Disk error	Unable to communicate continuously with memory media or data disk.	Power down machine and after a 10 seconds, power on again. If error remains, contact your Dealer.	
131	Device no ready	Memory media or data disk is not set.	Check if memory media or data disk is properly set.	5-5
133	Bad disk	Improper or faulty memory media or data disk.	Memory media that media reading unit can't read or faulty media or un-initialized media. Data disk that disk drive unit can't read or faulty data disk or un-initialized disk.	5-5
141	Not found name	Designated pattern is not found.	Memory media is not correct.	5-5
142	Disk full	Memory media is full to capacity.	Clear unnecessary patterns or use a different memory media.	
143	Multi name	Another pattern with same name has been detected while attempting to write to memory media.	Change name, use a different memory media, or overwrite existing pattern.	
190	Cut blade	Thread cut knife is not at stop position.	Follow the instructions below.	24-5
191	Cut Sensor	Thread cut knife is not at stop position.	Check if threads are jammed around the thread cutting knife. Press the thread cutting button 2~3 times. If error remains, contact your Dealer.	23-2 23-4
193	Catcher	Thread catch hook is off its position. Limit switch to detect position is not "OFF".	Please follow the example below: 1. Check whether thread was actually cut by thread cutting knife. If not, cut thread and return catch hook to its normal position. 2. If thread is actually cut, check if thread catch hook on head has returned to its position completely.	24-6
203	Install data	Error has occurred during update of program.	Check an update program.	
215	Frm. drive err	Frame movement did not complete during normal movement. (Time over)	If this condition occurs frequently, contact your Dealer.	
217	Frm.drive data	Frame movement data loose.		
255	Default Error	During embroidery, frame movement did not complete until main shaft reach "Lowest needle position".	Re-initialize machine speed setting. Check adjustment of upper shaft timing. (C point / L point) If this condition occurs frequently, contact your Dealer	25-2

## What to do for error (E-020 ~ E-026)

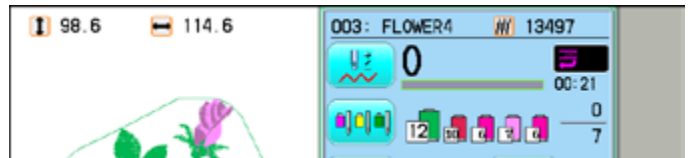


1. Press .



2. Select "Auto".

The Error status is cleared and the display shows "drive mode".



## When you cannot clear by the method above (Auto)




1. Press .



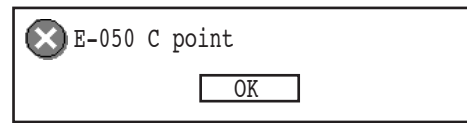
2. Select "Manual".

The Error status is cleared and the display shows "drive mode".



3. Refer to the page in the section (ERRORS AND WHAT TO DO), follow the steps outlined.  24-1

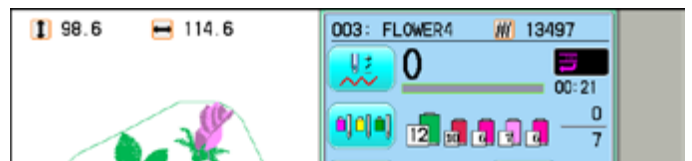
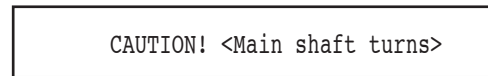
## What to do when Stop position of main shaft is out of place (error



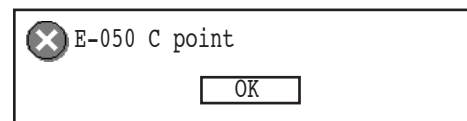
1. Press .
2. Select "Auto".




The main shaft turns 2 to 3 times and returns to a stop position ("C" point ) automatically. The display returns to drive mode.



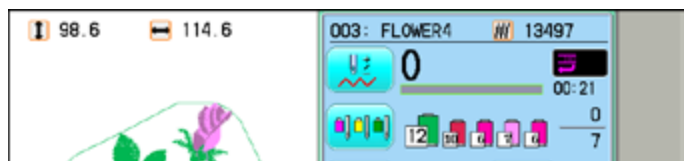
## When you cannot clear by the method above (Auto)



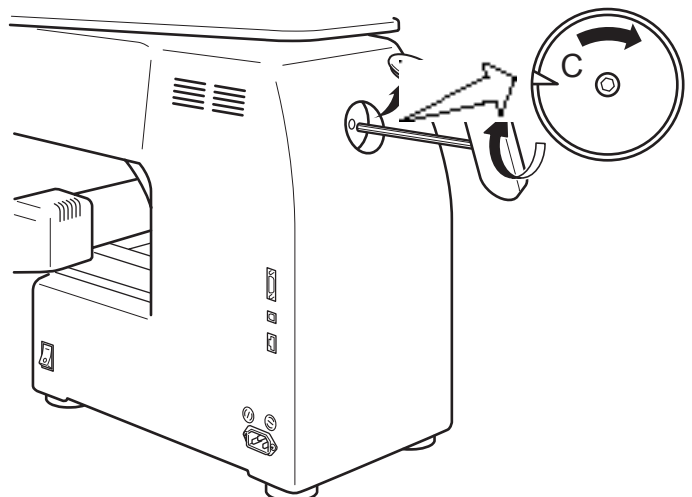
1. Press .
2. Select "Manual".



The error status is released and the display shows "drive mode".

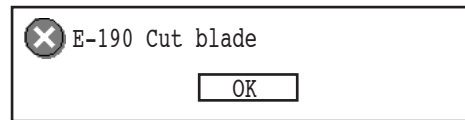


3. Remove the cap over the small hole in the rear of the machine. Using a 3 mm hexagonal driver, Please turn the main shaft and adjust it to the "C" point.





## What to do for “Thread cut knife is not at the stop position (error E-190)”

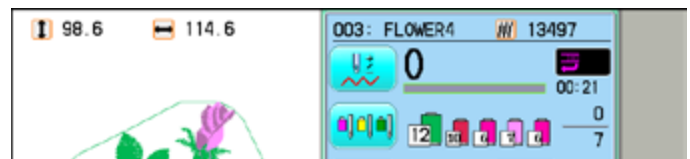


1. Press .

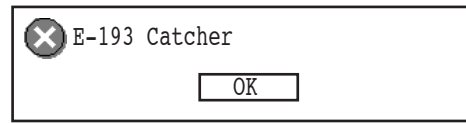


2. Select “Auto”.

The display returns to the drive mode.



## What to do for “Thread catch hook is off its position (error E-193)”

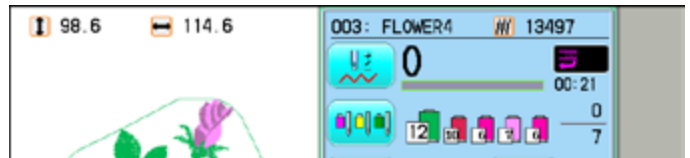


1. Press .

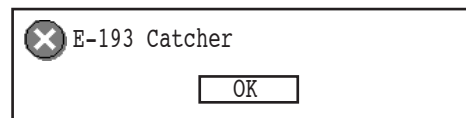


2. Select “Auto”.

The thread catch hook returns to the original position.  
The display returns to drive mode.



## When you cannot clear by the method above (Auto)



1. Press .



2. Select “Manual”.

The Error status is cleared and the display shows “drive mode”.



3. Refer to the page in the section (ERRORS AND WHAT TO DO), and determine what may be preventing the hook from returning to the original position, and follow the steps outlined. [P 24-3](#)

## ● Re-Initialization of machine system

Perform this function only to fix problems with the machine.

### Initialize the system

When performed, all settings in the "OPTION" menu are lost.  
Be sure to reset the "OPTION" menu after performing this function.

### Initialize the PMS

Please activate this function when the embroidery machine has malfunction after the operation with Happy PMS (Production management system). Please refer to instruction book of "Happy PMS" for more precise information.

### Initialize the Network

When performed, all settings in the "Network" menu are lost.

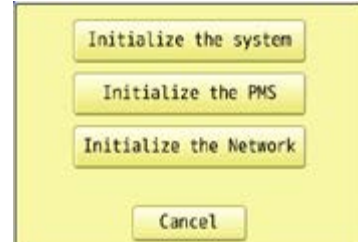
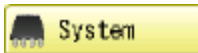
1. When the machine is stopped, press



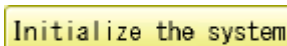
and Press "OTHER".



2. Press



3. Press

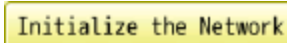


Go on to step 5.

Press

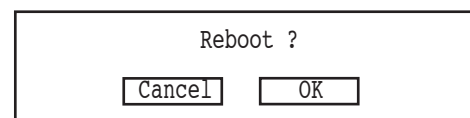
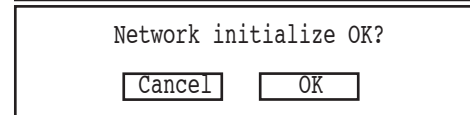
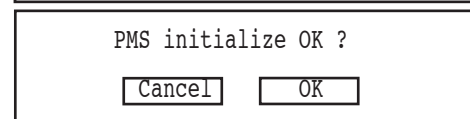
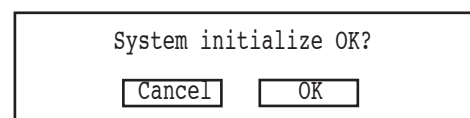


Press



Go on to step 5.

4. Press



5. Press



to carry out.  
Formatting of the machines systems are carried out.

Indicate HAPPY logo in screen.

If you cancel, press the





The display returns to MENU.



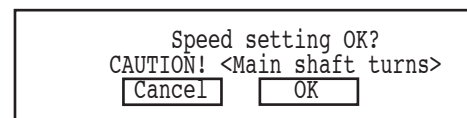
## ● Initializing of machine speed


If you have E-18, E-30, E-51 or E-52 while sewing, Please try initializing the machine settings.

1. When the machine is stopped, press  and Press  "OTHER".

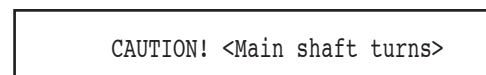


2. Press .

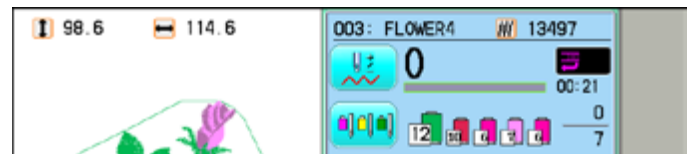


3. Press  to execute.

The machine will display a warning, then start turning the main shaft automatically. The speed will slowly increase from slowest speed to maximum and then stop automatically and return to Drive mode.



If you cancel, press the .



The display returns to MENU.

# HELPFUL HINTS

# 26-1

PROBLEM	CAUSE	CORRECTION	PAGE
Upper thread breaks	Machine not properly threaded.	Re-thread machine.	4-6
	Needle inserted incorrectly.	Re-insert needle. (remember, needles have a front and back!)	4-1
	Thread tension too tight.	Readjust thread tension.	8-1
	Poor thread quality.	Replace with good quality thread.	
	Dry hook	Oil the hook.	23-1
	Empty stitches or continuous tiny stitches in design data. Thread is tangled in an upper thread cone.	Turn on stitch sweep function, then read design data in again. Un-tangle thread.	10-3
Lower (bobbin) thread breaks	Bobbin threaded incorrectly.	Re-thread the bobbin.	4-5
	Bobbin wound unevenly or too full.	Re-wind the bobbin.	4-4
	Thread tension too tight.	Readjust thread tension.	4-5
	Dirt on the hook.	Clean the hook.	23-2
	Dry hook	Oil the hook.	23-1
Thread break lamp lights up despite thread not being broken (False thread breaks)	Upper thread is not passing around the detecting roller.	Thread upper thread correctly.	4-7
Machine skips stitches	Needle inserted incorrectly.	Re-insert needle.	4-1
	Bent or blunt needle.	Insert new needle.	4-1
	Incorrect size of needle.	Choose correct size needle for fabric.	4-2
Fabric puckers	Machine not properly threaded.	Re-thread machine.	4-6
	Bobbin threaded incorrectly.	Re-thread the bobbin.	4-5
	Blunt needle.	Insert new needle.	4-1
	Thread tension too tight.	Readjust thread tension.	8-1
Machine makes loose stitches or loops	Bobbin threaded incorrectly.	Re-thread the bobbin.	4-5
	Machine not properly threaded.	Re-thread machine.	4-6
	Tension not adjusted properly.	Readjust thread tension.	4-5,8-1
Poor tension balance	Bobbin threaded incorrectly.	Re-thread the bobbin.	4-5
	Machine not properly threaded.	Re-thread machine.	4-6
	Dry hook	Oil rotary hook.	23-1
Poor design registration	Fabric not hooped correctly.	Set hooping correctly.	6-2,7-9
	Garment is made of elastic material.	Use correct backing and ensure that design has proper underlay.	6-2,7-9
	Hoop not installed into machine properly.	Set hoop correctly.	6-3 7-A
Needle breaks	Bent or blunt needle.	Insert new needle.	4-1
	Needle setting incorrect.	Re-insert needle.	4-1
	Thin needle against material.	Change to thicker needle.	4-2
	Poor hooping.	Re-hoop fabric.	
Machine runs with difficulty	Dirt on the hook race.	Clean rotary hook.	23-2
		Oil rotary hook.	23-1
Machine will not run	Cord not plugged into electrical outlet.	Insert plug fully into outlet.	
	Power switch is not turned on.	Turn on the switch.	5-1
	Power source fuse has blown.	Replace power source fuse (6A).	3-1
will not turn on	Locking emergency button.	Release lock of emergency button.	3-3

## Thread break back

With this setting, drive frame backs up several stitches after a thread break before stopping.

## Color change number

The Needle number (thread color) to be sewn can be set to each Color change number. For example, if a pattern is divided by a color change function in 2 places, 3 color change numbers exist in the pattern. When the needle number is set to its respective color change number, the pattern is sewn in 3 colors.

## Memory pattern

Patterns stored in memory.

## Start point of the frame

This is the point where the frame begins to move before the machine starts sewing.

## Various function settings

A general term for Needle bar selection, Convert, Pattern adjustment, Repeat sewing, Offset and frame out which are set in the pattern data.

## Zero stitch

This is a stitch whose net movement in both the X- and Y- direction is zero, and the needle lands in the same position.

## Original Point

The frame position where the machine embroiders the pattern from the beginning is automatically registered as the original point.

## Stitches

This is the minimum unit within the pattern data. There are different types of such "stitches": "stitches" that command determine the sewing sequence; "functions" that dictate functions such as jumps, thread cut, etc; "sideways movement distance" and "lengthwise movement distance" that command the movement distance of the frame.

## Auto origin

This returns the frame automatically to the original point upon finishing the embroidery.

## Tubular round frame, Tubular square frame

The frames made by HAPPY and used for cylinder sewing, such as on T-shirts, bags, etc. These frames have brackets at both sides.

## Memory media

What saves design data by things, such as memory card and a USB flash drive.

## Data format

This is the format that the pattern data is converted into/

## Color change stop

When a color change stop is assigned to a color change number, the machine embroiders the set color change and stops.

## Conversion

This is a user-adjustable design setting of a given pattern that allows rotation in increments of 90 degrees.

## Pattern data

Embroidery data that has been converted to the format such as TAP, DST, DSB, DSZ.

Basic script, Diacritic script

<p>ABC</p>	<p>ABCDEFGHIJKLMNOPQRSTUVWXYZ                  abcdefghijklmnopqrstuvwxyz                  0123456789,./!&lt;&gt;()&amp;-@_:                  ÀÁÂÃÄÅÆÇÐĎÈÉÊËĚÍÎÏÑŃÓÔÕÖŐØŒ                  ŔŠŤÙÚÛÜŮÚÝŽ                  àáâãäåæççďèéêëěíîïñňóôõöőøœ                  řšťùúûüůúýžß</p>
<p>ABC</p>	<p>ABCDEFGHIJKLMNOPQRSTUVWXYZ                  abcdefghijklmnopqrstuvwxyz                  0123456789,./!&lt;&gt;()&amp;- '@_:                  ÀÁÂÃÄÅÆÇÐĎÈÉÊËĚÍÎÏÑŃÓÔÕÖŐØŒ                  ŔŠŤÙÚÛÜŮÚÝŽ                  àáâãäåæççďèéêëěíîïñňóôõöőøœ                  řšťùúûüůúýžß</p>
<p>ABC</p>	<p><i>ABCDEFGHIJKLMNOPQRSTUVWXYZ                  abcdefghijklmnopqrstuvwxyz                  0123456789,./!&lt;&gt;()&amp;- '@_                  ÀÁÂÃÄÅÆÇÐĎÈÉÊËĚÍÎÏÑŃÓÔÕÖŐØŒ                  ŔŠŤÙÚÛÜŮÚÝŽ                  àáâãäåæççďèéêëěíîïñňóôõöőøœ                  řšťùúûüůúýžß</i></p>
<p>ABC</p>	<p><b>A B C D E F G H I J K L M N O P Q R S T U V W X Y Z</b>  <b>abcdefghijklmnopqrstuvwxyz</b>  <b>0123456789,./!&lt;&gt;()&amp;- '@_:</b>  <b>À Á Â Ã Ä Å Æ Ç Ð Ď È É Ê Ë Ě Í Î Ï Ñ Ń Ó Ô Õ Ö Ő Ø Œ</b>  <b>Ŕ Š Ť Ù Ú Û Ü Ů Ú Ý Ž</b>  <b>à á â ã ä å æ ç ç ď è é ê ë ě í î ï ñ ñ ó ô õ ö ő ø œ</b>  <b>ř š ť ù ú û ü ů ú ý ž ß</b></p>
<p>ABC</p>	<p><i>ABCDEFGHIJKLMNOPQRSTUVWXYZ                  abcdefghijklmnopqrstuvwxyz                  0123456789,./!&lt;&gt;()&amp;- '@_:                  À Á Â Ã Ä Å Æ Ç Ð Ď È É Ê Ë Ě Í Î Ï Ñ Ń Ó Ô Õ Ö Ő Ø Œ                  Ŕ Š Ť Ù Ú Û Ü Ů Ú Ý Ž                  à á â ã ä å æ ç ç ď è é ê ë ě í î ï ñ ñ ó ô õ ö ő ø œ                  ř šť ù ú û ü ů ú ý ž ß</i></p>





































































































<p><b>ABC</b></p>	<p><b>ABCDEFGHIJKLMNOPQRSTUVWXYZ</b>  <b>ABCDEFGHIJKLMNOPQRSTUVWXYZ</b>  <b>0123456789,./!/?&lt;&gt;()&amp;-'@_:</b>  <b>À Á Â Ã Ä Å Æ Ç Ñ È É Ê Ë Ì Í Î Ñ Ò Ó Ô Õ Ö Ø Ù</b>  <b>Ř Š Ť Û Ü Ú Û Ü Ý Ž</b>  <b>À Á Â Ã Ä Å Æ Ç Ñ È É Ê Ë Ì Í Î Ñ Ò Ó Ô Õ Ö Ø Ù</b>  <b>Ř Š Ť Û Ü Ú Û Ü Ý Ž ß</b></p>
<p><i>ABC</i></p>	<p><i>ABCDEFGHIJKLMNOPQRSTUVWXYZ</i>  <i>abcdefghijklmnopqrstuvwxyz</i>  <i>0123456789,./!/?&lt;&gt;()&amp;-'@_:</i>  <i>À Á Â Ã Ä Å Æ Ç Ñ È É Ê Ë Ì Í Î Ñ Ò Ó Ô Õ Ö Ø Ù</i>  <i>Ř Š Ť Û Ü Ú Û Ü Ý Ž</i>  <i>à á â ã ä å æ ç Ñ è é ê ë ì í î ñ ò ó ô õ ö ø ù</i>  <i>ř š ť ù ú û ü ý ž ß</i></p>
<p><b>ABC</b></p>	<p><b>ABCDEFGHIJKLMN OPQRSTUVWXYZ</b>  <b>ABCDEFGHIJKLMN OPQRSTUVWXYZ</b>  <b>0123456789,./!/?&lt;&gt;()&amp;-'@_:</b>  <b>À Á Â Ã Ä Å Æ Ç Ñ È É Ê Ë Ì Í Î Ñ Ò Ó Ô Õ Ö Ø Ù</b>  <b>Ř Š Ť Û Ü Ú Û Ü Ý Ž</b>  <b>À Á Â Ã Ä Å Æ Ç Ñ È É Ê Ë Ì Í Î Ñ Ò Ó Ô Õ Ö Ø Ù</b>  <b>Ř Š Ť Û Ü Ú Û Ü Ý Ž</b></p>
<p><i>ABC</i></p>	<p><i>ABCDEFGHIJKLMN OPQRSTUVWXYZ</i>  <i>abcdefghijklmnopqrstuvwxyz</i>  <i>0123456789,./!/?&lt;&gt;()&amp;-'@_:</i>  <i>À Á Â Ã Ä Å Æ Ç Ñ È É Ê Ë Ì Í Î Ñ Ò Ó Ô Õ Ö Ø Ù</i>  <i>Ř Š Ť Û Ü Ú Û Ü Ý Ž</i>  <i>à á â ã ä å æ ç Ñ è é ê ë ì í î ñ ò ó ô õ ö ø ù</i>  <i>ř š ť ù ú û ü ý ž ß</i></p>
<p><b>ABC</b></p>	<p><b>ABCDEFGHIJKLMN OPQRSTUVWXYZ</b>  <b>abcdefghijklmnopqrstuvwxyz</b>  <b>0123456789,./!/?&lt;&gt;()&amp;-'@_:</b>  <b>À Á Â Ã Ä Å Æ Ç Ñ È É Ê Ë Ì Í Î Ñ Ò Ó Ô Õ Ö Ø Ù</b>  <b>Ř Š Ť Û Ü Ú Û Ü Ý Ž</b>  <b>à á â ã ä å æ ç Ñ è é ê ë ì í î ñ ò ó ô õ ö ø ù</b>  <b>ř š ť ù ú û ü ý ž ß</b></p>





# BUILT-IN PATTERN LIST

# 26-4

 D001	 D002	 D003	 D004	 D005	 D061	 D062	 D063	 D064	 D065
 D006	 D007	 D008	 D009	 D010	 D066	 D067	 D068	 D069	 D070
 D011	 D012	 D013	 D014	 D015	 D071	 D072	 D073	 D074	 D075
 D016	 D017	 D018	 D019	 D020	 D076	 D077	 D078	 D079	 D080
 D021	 D022	 D023	 D024	 D025	 D081	 D082	 D083	 D084	 D085
 D026	 D027	 D028	 D029	 D030	 D086	 D087	 D088	 D089	 D090
 D031	 D032	 D033	 D034	 D035	 D091	 D092	 D093	 D094	 D095
 D036	 D037	 D038	 D039	 D040	 D096	 D097	 D098	 D099	 D100
 D041	 D042	 D043	 D044	 D045					
 D046	 D047	 D048	 D049	 D050					
 D051	 D052	 D053	 D054	 D055					
 D056	 D057	 D058	 D059	 D060					

BUILT IN PATTERN includes clip art from [Master clip] created by H2soft (Fax:+81-422-28-5211 E-mail:support@office4dc.co.jp).

Special frames for various purposes are available as options.

Use a special frame corresponding to the material and shape of the object to be embroidered.

- One-Point Embroidery Frame
- Shoe Clamp Frame
- Side Clamp Frame
- Square Clamp Frame
- One Touch Frame
- Tubular Sock Frame Holder

**HCH\*,HCS\*,HCD\*,  
HCU\*,HCR\***

**One-Point Embroidery Frame (small) / (large)  
Long One-Point Embroidery Frame  
INSTRUCTION MANUAL**

FOU701-9

**IMPORTANT SAFETY INSTRUCTIONS**

**0**



- Use this Manual together with Instruction Manual of embroidery machine for mounting this appliance and for operating.
- Use this appliance only for its intended use as described in this manual. Use only attachments recommended by the manufacturer as contained in this manual.
- Keep fingers away from all moving parts. Special care is required around the sewing machine needle.
- Do not pull or push fabric while stitching. It causes damage.
- Do not modify this appliance.

**SAVE THESE INSTRUCTIONS**

Basic information of One-point frame .....	1-1
Frames	
One-point frame .....	1-2
Long One-point frame .....	1-3
Preparation .....	2-1
One-point frame settings	
HCH*, HCS* .....	3-1
HCD*, HCU*, HCR* .....	3-2
Adjustment of One-point frame .....	4-1
Hooping fabric	
One-point frame .....	4-2
Long One-point frame .....	4-4
Starting to sew .....	5-1
Frame confirmation .....	6-1
Installing and removing the guide .....	7-1
Exchanging setting plate .....	8-1
etc.	
Exchange Cushion .....	9-1

# BASIC INFORMATION OF ONE-POINT FRAME 1-1

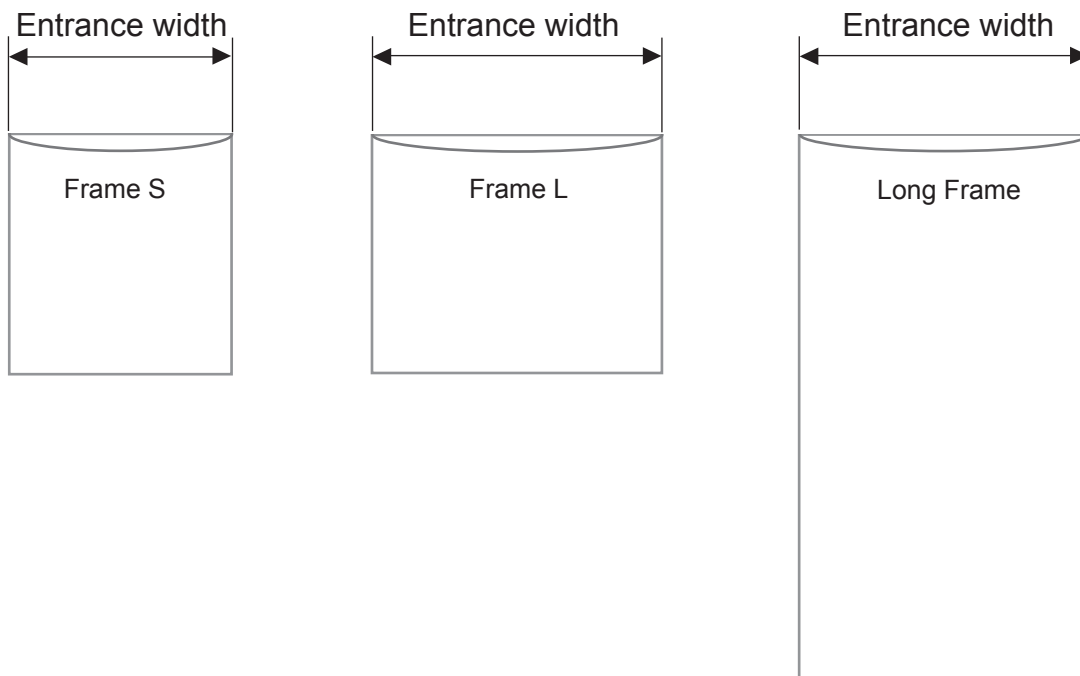
- Please read all instructions before using this appliance.

- The entrance width of item for the One-point Frame

	Entrance width
One-point Frame S	: more than 105mm
One-point Frame L	: more than 130mm
Long One-point Frame	: more than 170mm

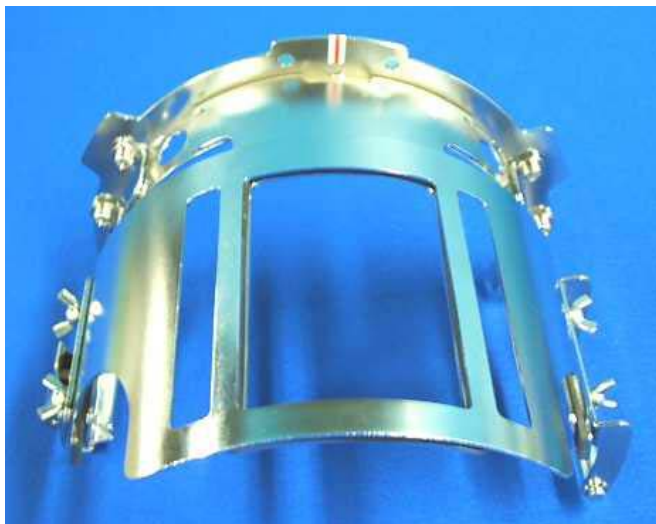
- Long One-point Frame cannot be used for HCH\*, HCS\*, HCR\* machine.

- Sizes will be changed by type of fabric and form of item. Please check before using this frame.



## ● One-point frame

FRA48010 One-point frame (small)  
 EMB. area (YxX) : 60 x 40 mm  
 55 x 40 mm (HCH\*, HCS\*)



FRA48020 One-point frame (large)  
 EMB. area (YxX) : 60 x 76 mm  
 55 x 76 mm (HCH\*, HCS\*)



## Accessories

FRA48140 W-clip  
 (packed with frame)

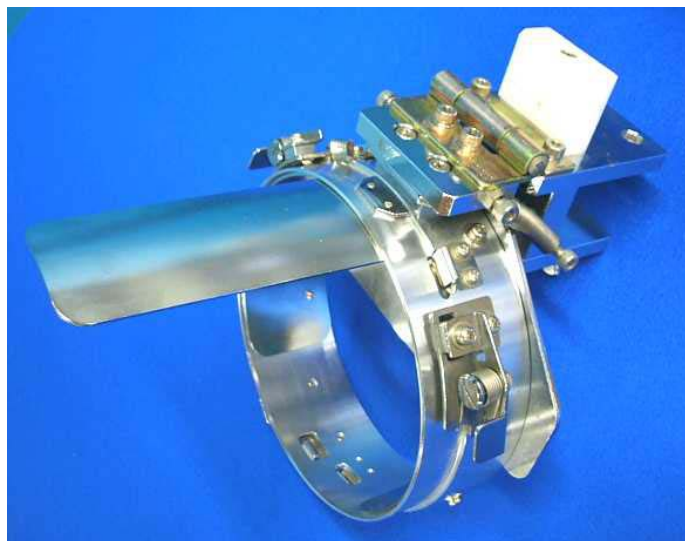


FRA48130 Cushion  
 (packed with frame)



## ● Setting base

FRA48111 One-point frame setting base



FRA48120 One-point frame setting plate



You can modify setting base from cap stretcher by exchanging setting plate.

## ● Long One-point frame

FRA48160

EMB. area (YxX) : 200 x 55 mm



## Accessories

FRA48140 W-clip  
(packed with frame)



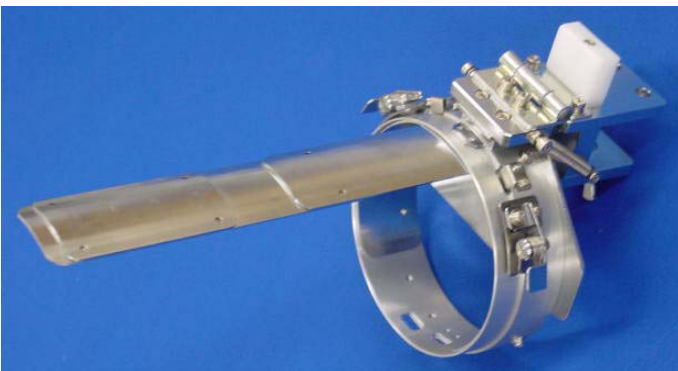
FRA48130 Cushion  
(packed with frame)



## ● Long One-point frame setting base

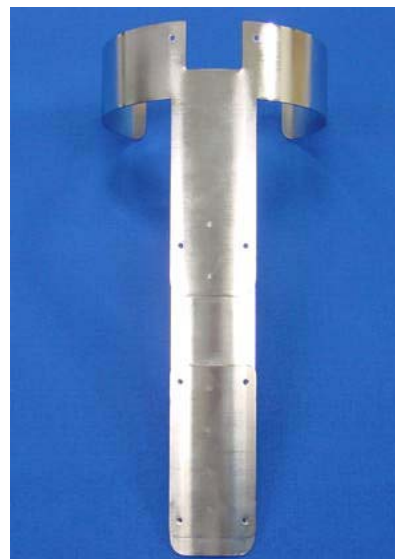
FRA48200

Long one-point frame setting base



FRA48210

Long one-point frame setting plate




You can modify setting base from cap stretcher by exchanging setting plate.



The following preparation steps are required for using One-point Frame.

1. Prepare Drive Frame which Guide is not installed.

The following preparation steps are required for using One-point Frame.  7-1




Drive Frame without Guide

2. Install Drive Frame.

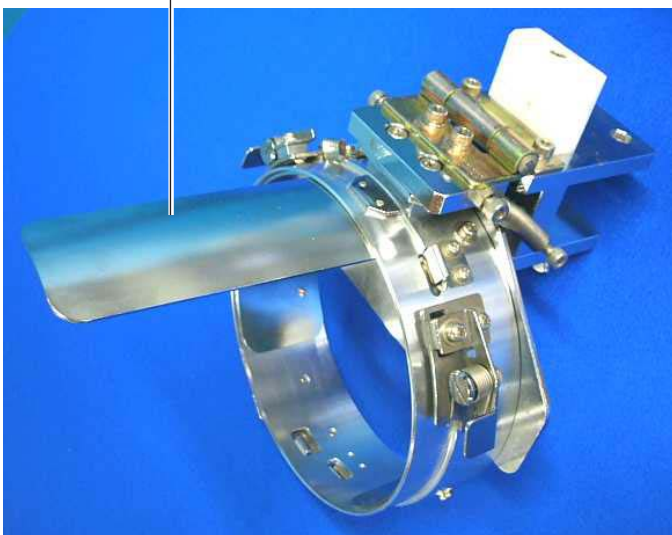
Please refer to "[CAP FRAME]-[Installing and removing the cap drive frame]" in machine instruction manual.

3. Prepare One-point frame setting base.

In case you have Cap Stretcher, you can modify it by exchanging setting plate.  8-1

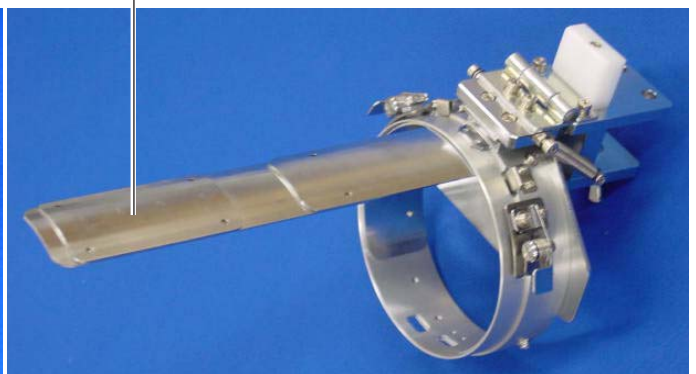
## One-point frame setting base (for S, L)

One-point frame setting plate



## Long One-point frame setting base


Long one-point frame setting plate



# ONE POINT FRAME SETTINGS

# 3-1

One Point Frame has 2 different size (S size and L size).  
When you use One Point Frame, please make machine setting according to frame size selected.

 **CAUTION: To avoid problems.**  
The machine and / or One point frame may be damaged if the incorrect frame settings are used.


## HCH\*, HCS\*

1. Turn on the power switch.


Indicates the selected frame.

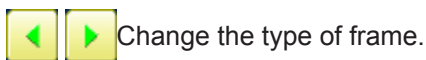


2. In case required One-point frame is already selected, press the **Next** and jump to operation no.4.

In case selected frame type is not same as your requirement, press .

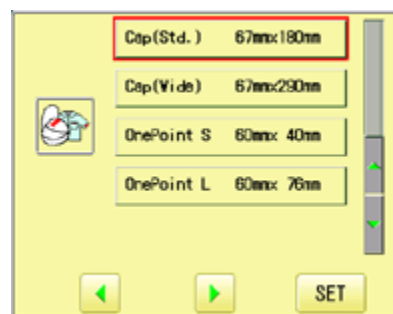


3. Select  "Cap and One-point frame".



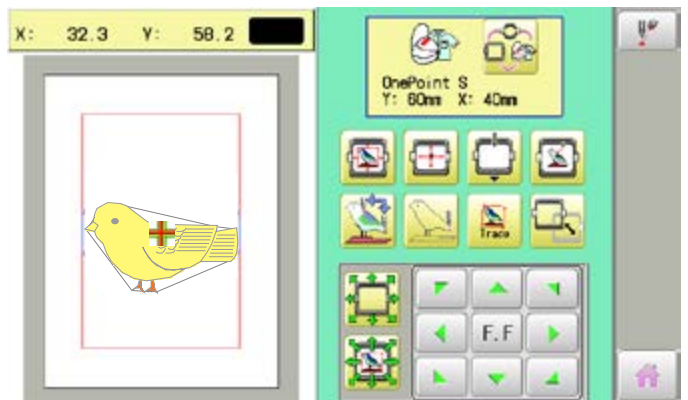
Change the type of frame.

OnePoint S : One-point frame (small)  
OnePoint L : One-point frame (large)



4. Select desired size of frame and press **SET**.

The embroidery area and outline of the pattern itself appear in red. All are displayed on the left together.



# ONE-POINT FRAME SETTINGS

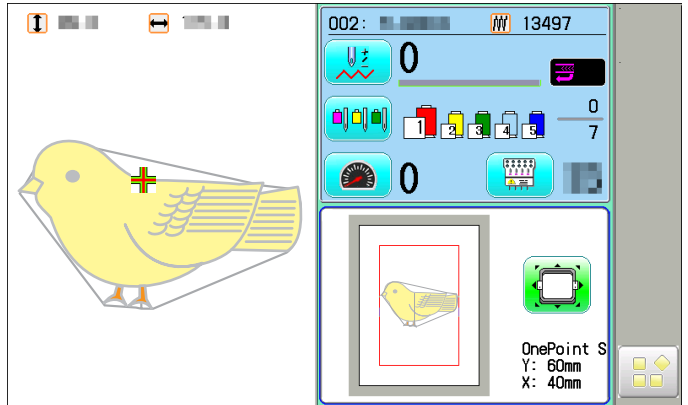
3-2

**CAUTION: To prevent accidents.**  
The frame moves quickly.  
Keep hands away from the frame.


5. Press .

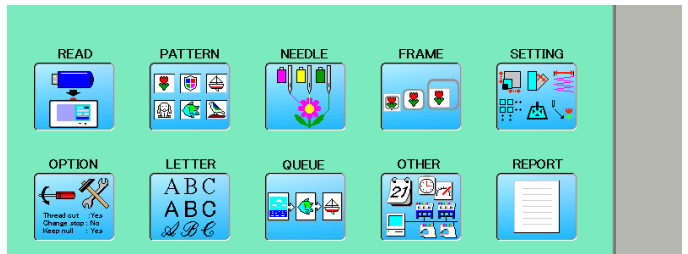
After the carriage and frame move slightly, the embroidery frame will return to the previous position automatically.  
Machine becomes ready for operation.

One-point frame will be shown in the lower right corner of the screen.  
Then One-point frame will be set.




## HCD\*, HCU\*, HCR\*



1. When the machine is stopped, press .



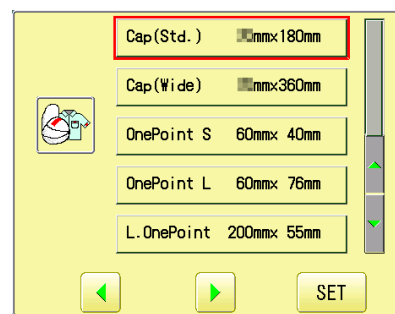
2. Select "FRAME".




3. Select  "Cap and One-point frame".

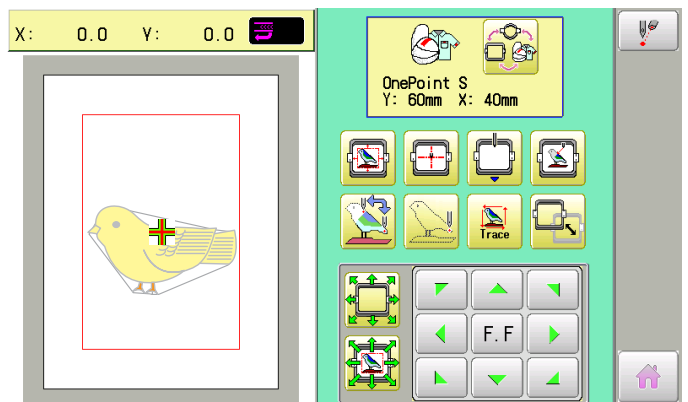
  Change the type of frame.

- OnePoint S : One-point frame (small)
- OnePoint L : One-point frame (large)
- L.OnePoint : Long One-point frame (except for HCR\*)



4. Select desired size of frame and press .

The embroidery area and outline of the pattern itself appear in red. All are displayed on the left together.





## CAUTION: To prevent accidents.

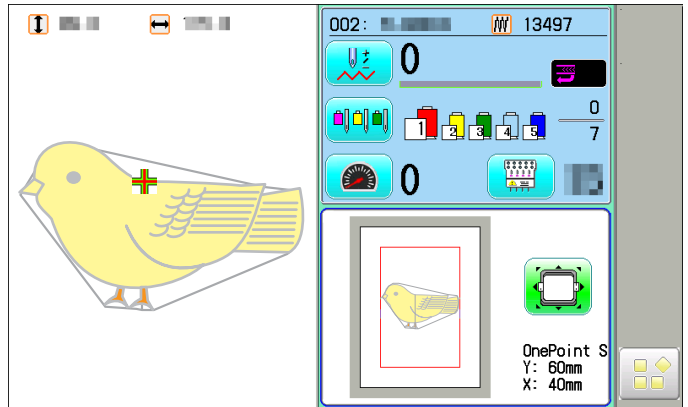
The frame moves quickly.  
Keep hands away from the frame.

5. Press



After the carriage and frame move slightly, the embroidery frame will return to the previous position automatically.  
Machine becomes ready for operation.

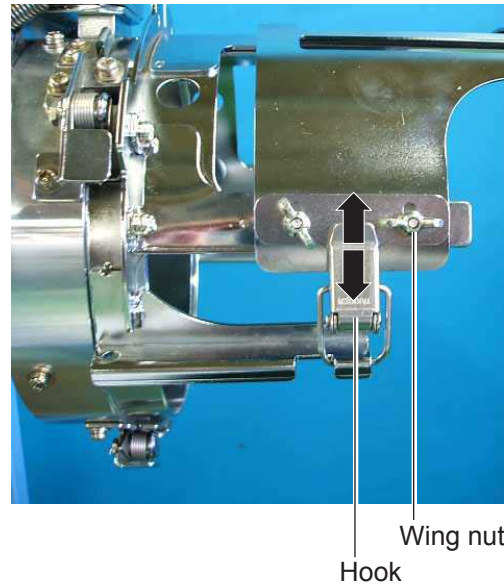
One-point frame will be shown in the lower right corner of the screen.  
Then One-point frame will be set.



The following adjustment is required for setting fabric.

1. Adjust the position of Hook according to the thickness of the fabric for keeping proper clamp tension. The hook has to be closed and opened without high tension. For adjustment of tension, use the wing nuts. In case you have no allowance to adjust tension for thick fabric, refer operation no.2 and adjust tension.

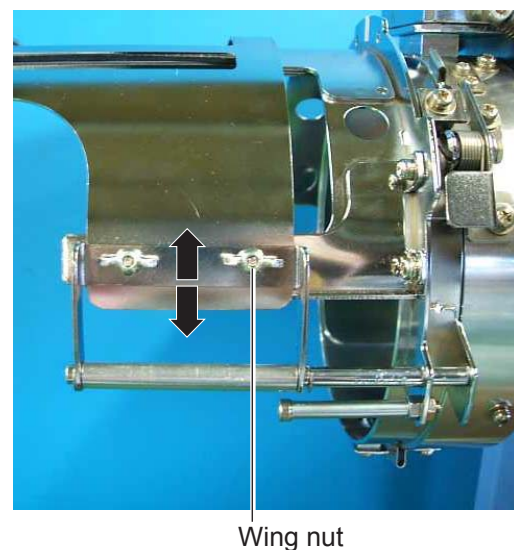
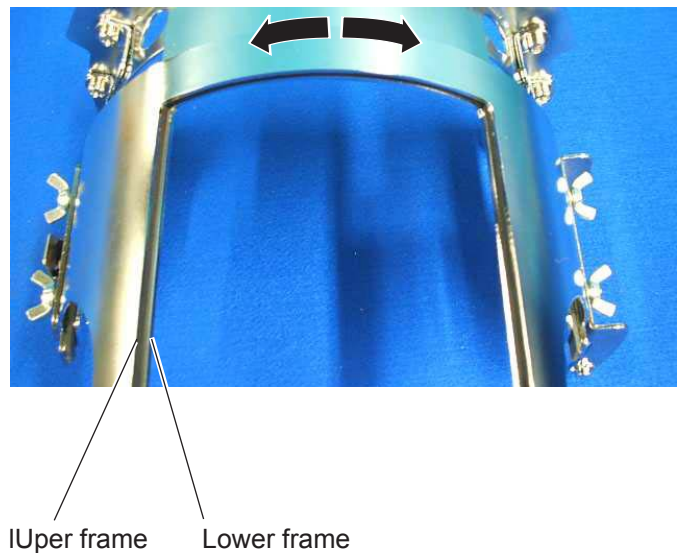
If the hook has extremely high tension, it will damage frame itself.



2. In case position of upper and lower frame is not matching because of thickness of fabric, adjust position of upper frame by wing nuts.

The upper frame should be parallel to the lower frame.

If position is not parallel, fabric is not held firmly and it may happen that frame hits pressure foot and damages machine.

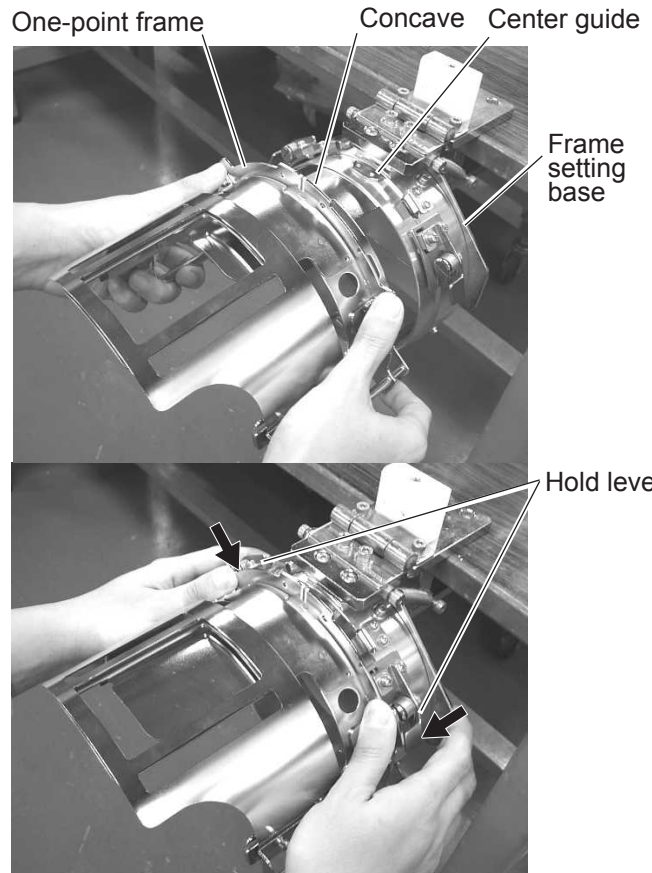


## One-point frame

As example, pocket setting for dress shirts is introduced.

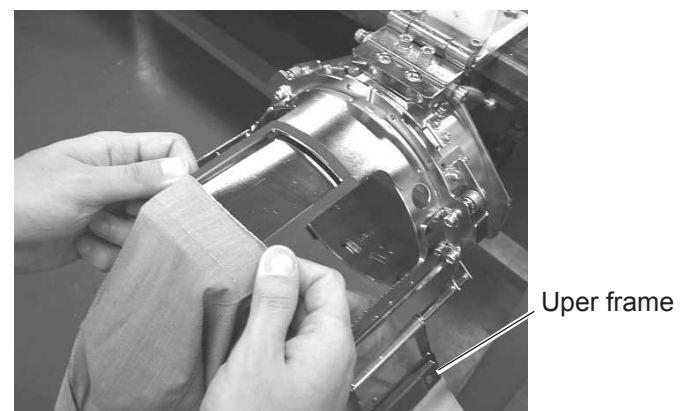
1. Place Frame setting base securely on a sturdy work bench.
2. Hold One-point frame with both hands and place on Frame setting base.  
By pushing Hold levers at 2 places with fingers, place One-point frame so that center guide of Frame setting base fits in concave area of One-point frame.

Confirm that the Frame is securely placed on Frame setting base.

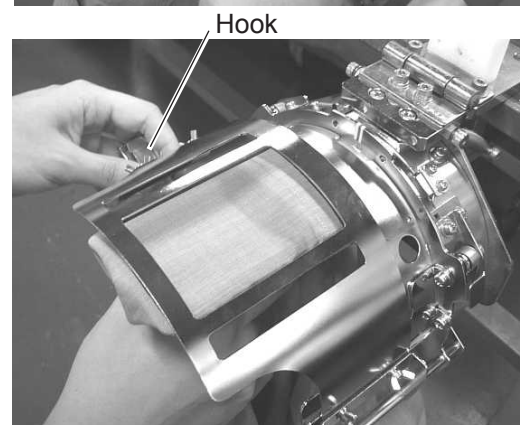


3. Open upper frame and keep open to the right.
4. Set pocket to frame with opening pocket.

Please place one or two sheets of nonwoven fabric (backing) of standard thickness under unstructured fabrics.



5. Pull back fabrics and hook it on the hook and smooth out creases on fabrics.
6. Latch the hook, taking care not to cause wrinkles in the fabrics.



7. Remove the One-point frame from the Frame setting base.
8. Set frame on Cap frame driver with opening pocket. Please confirm bed of machine is entered into pocket. Then, push the holder lever in the 2 places shown, and place the One-point frame on so that the center guide of the Cap drive frame assembly fits into the One-point frame notch.

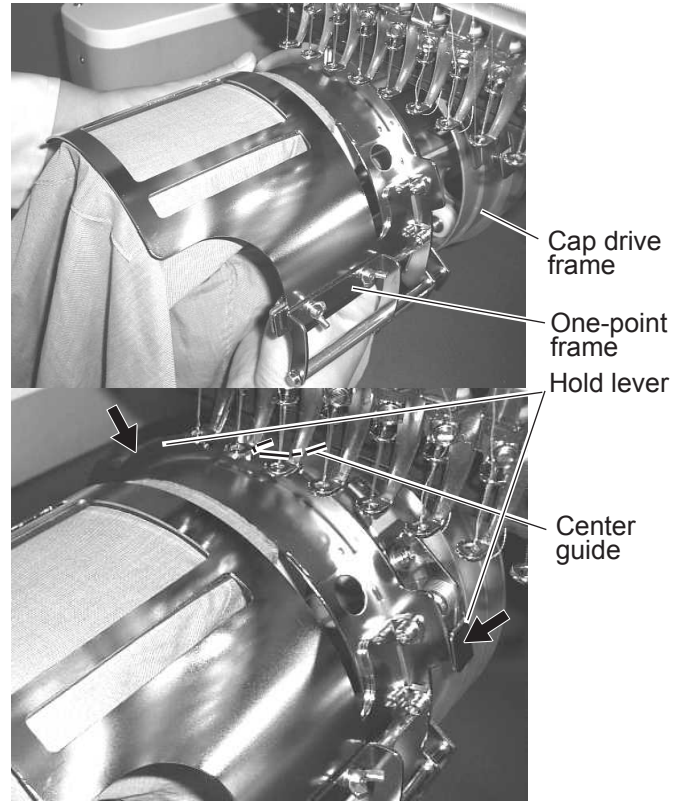
Confirm that the Frame is firmly seated on the cap drive frame assembly without any gaps. If there is a gap between the Frame or the cap drive frame holding lever doesn't go into the hole of the Frame, loosen the set screw on the hold lever for adjustment.



**CAUTION: To avoid problems.**

Do not power machine on, when frame is placed with fabric.

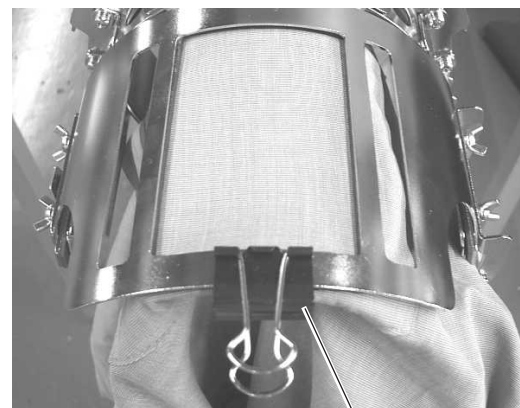
Machine may move wider area than embroidery area of frame and damage frame, machine and fabric



## W-clip

W-clip is used when you make embroidery on stretch fabric or thin fabric.

Especially large design or many filling stitches is required, fabric may shrink.

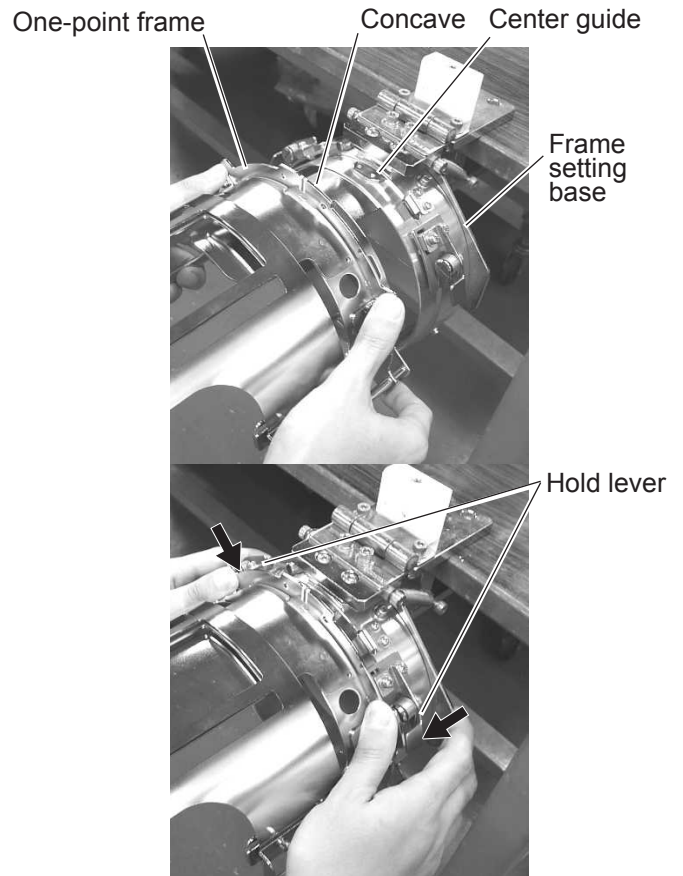


## Long One-point frame

As example, sleeve setting for dress shirts is introduced.

1. Place Frame setting base securely on a sturdy work bench.
2. Hold One-point frame with both hands and place on Frame setting base.  
By pushing Hold levers at 2 places with fingers, place One-point frame so that center guide of Frame setting base fits in concave area of One-point frame.

Confirm that the Frame is securely placed on Frame setting base.

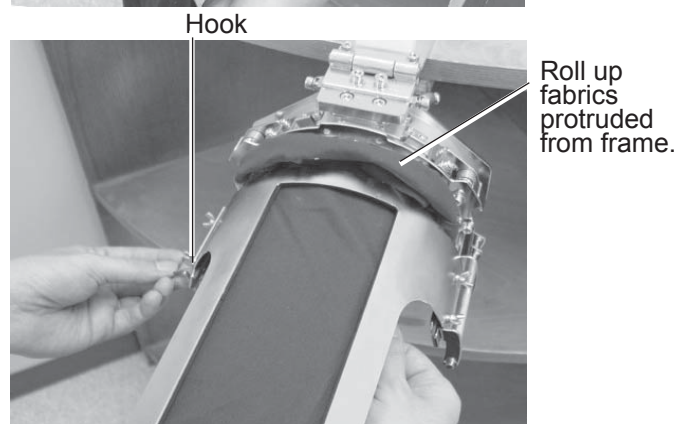


3. Open upper frame and keep open to the right.
4. Set pocket to frame with opening pocket.

Please place one or two sheets of nonwoven fabric (backing) of standard thickness under unstructured fabrics.



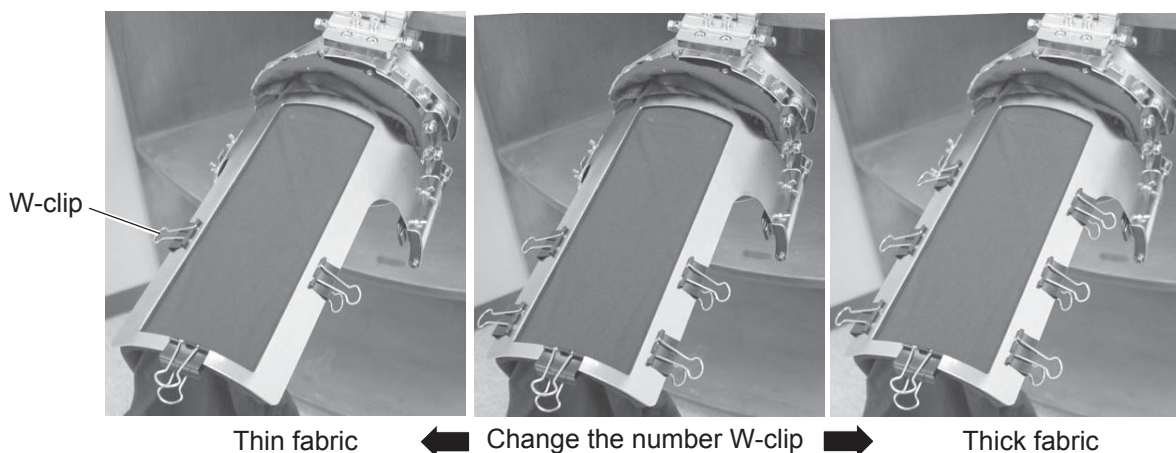
5. Pull back fabrics and hook it on the hook and smooth out creases on fabrics.
6. Latch the hook, taking care not to cause wrinkles in the fabrics.





## 7. Fasten around frame with bundled W-clips.

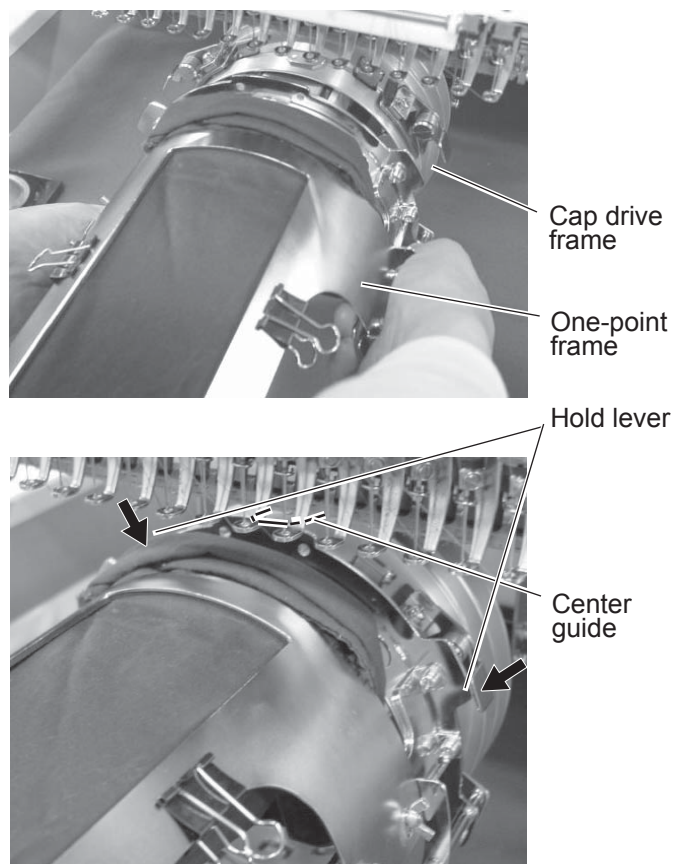
Use more W-clips when you make embroidery on stretch fabric or thin fabric. Especially large design or many filling stitches is required, fabric may shrink.



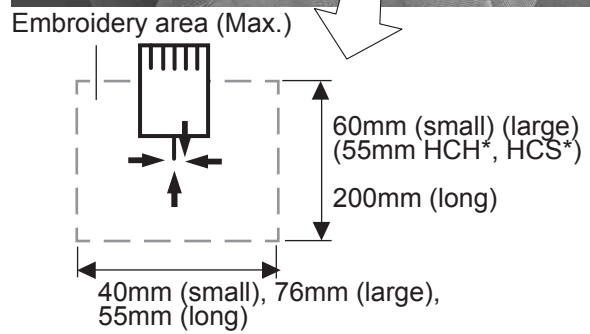
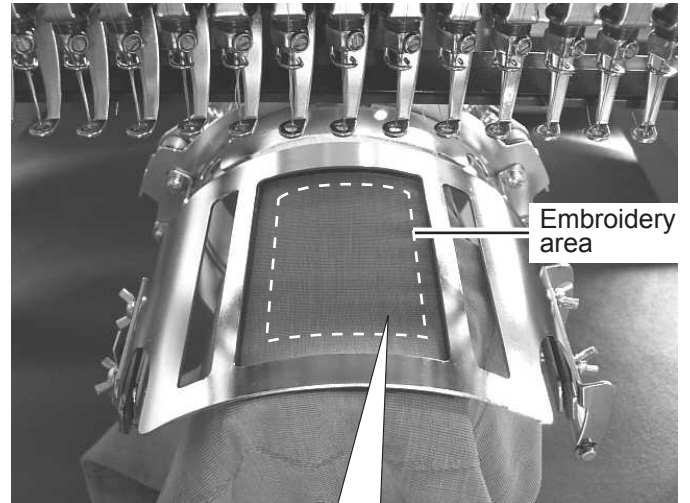
## 8. Remove the One-point frame from the Frame setting base.

## 9. Set frame on Cap frame driver with opening pocket. Please confirm bed of machine is entered into pocket. Then, push the holder lever in the 2 places shown, and place the One-point frame on so that the center guide of the Cap drive frame assembly fits into the One-point frame notch.

Confirm that the Frame is firmly seated on the cap drive frame assembly without any gaps. If there is a gap between the Frame or the cap drive frame holding lever doesn't go into the hole of the Frame, loosen the set screw on the hold lever for adjustment.




**CAUTION: To avoid problems.**  
Do not power machine on, when frame is placed with fabric.  
Machine may move wider area than embroidery area of frame and damage frame, machine and fabric




1. Press the  and move the frame to the original




2. Press the 

Press , and the embroidering frame moves for the design trace. Make sure that the pressure foot and needle do not touch the frame.

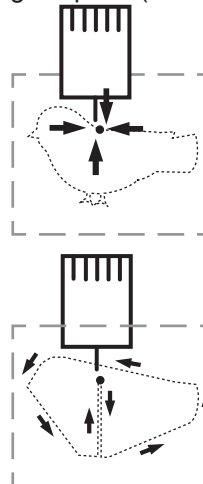
Press , and trace is stopped.

Go on to step 4 if you want to start embroidering without tracing.

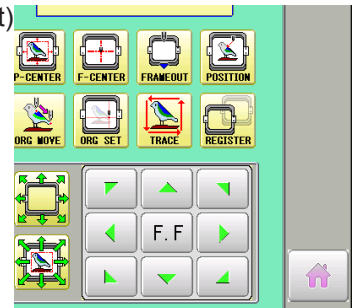
3. Press  after the trace is completed.

The embroidering frame has moved to the first stitch point of the pattern.

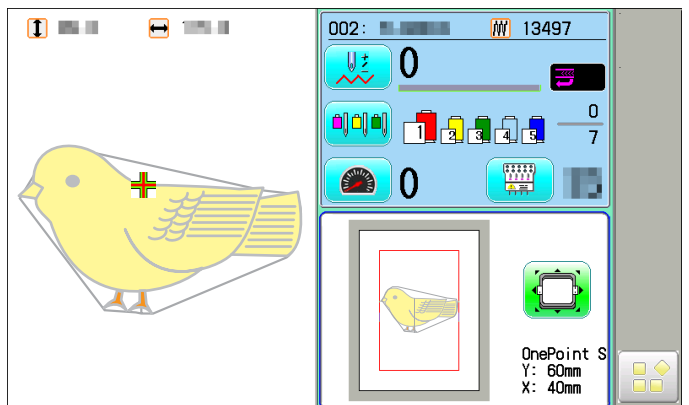
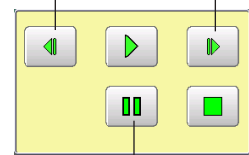
●:Original point (Start point)




You can confirm the outline and position of design.



Backward only when pressing  
Forward only when pressing



4. Press the .

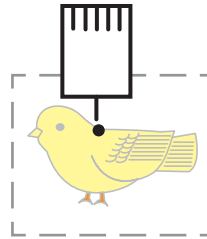
The embroidery will start.

5. After finishing your design, the display will show ">>End" and the machine will stop.

The embroidery frame returns to the original point automatically if the auto origin function has been activated.

>>End

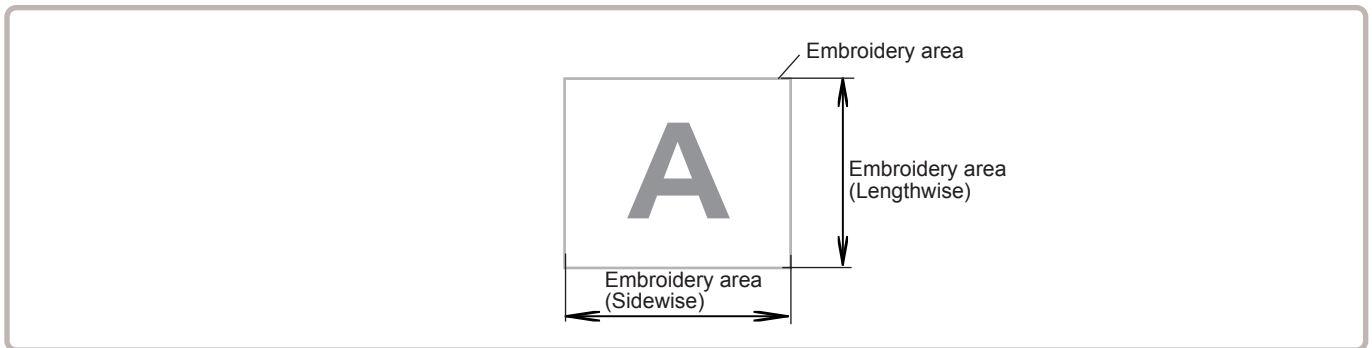
●:Original point (Start point)




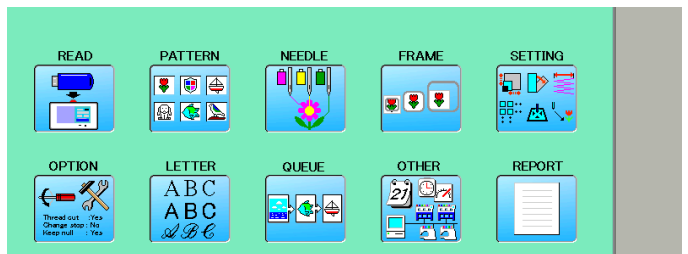
# FRAME CONFIRMATION

# 6-1

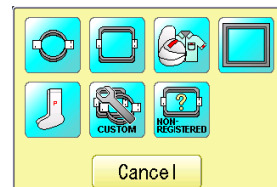
The embroidery area of HAPPY One-point frame S and One-point frame L is saved in the machine. This allows confirmation of positioning between the embroidery area and the pattern.






1. When the machine is stopped, press .



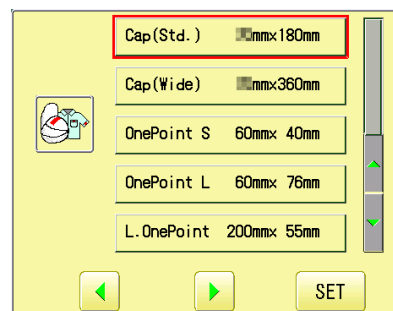
2. Select "FRAME".



2. Select  "Cap and One-point frame".


  Change the type of frame.

- OnePoint S : One-point frame (small)
- OnePoint L : One-point frame (large)
- L.OnePoint : Long One-point frame (except for HCH\*, HCS\*, HCR\*)

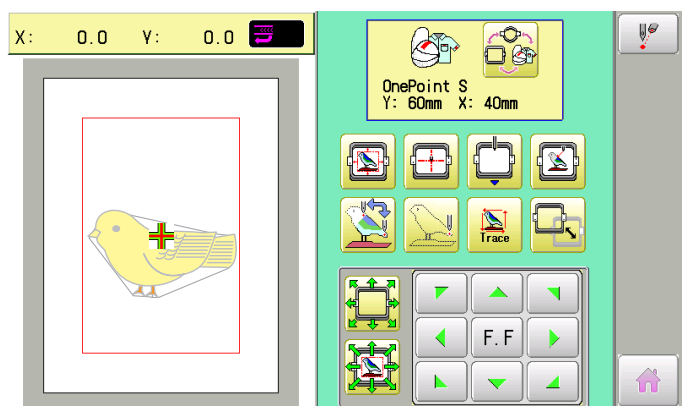


4. Select desired frame and press .

The embroidery area and outline of the pattern itself appear in red. All are displayed on the left together.

5. Confirm that  (Top) appears in the display and go to step 7.

If this does not appear, go to step 6.




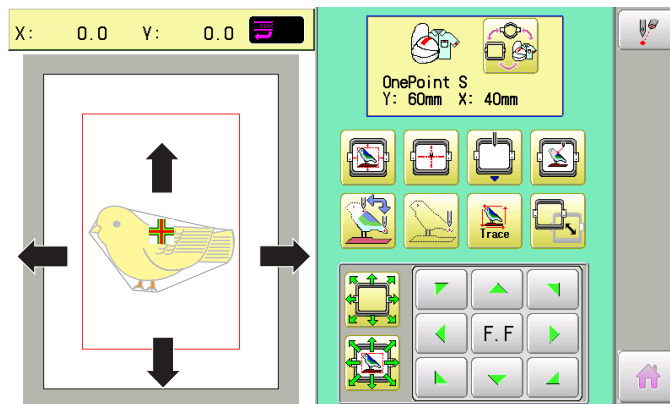
# FRAME CONFIRMATION

# 6-2

6. Press  "Top".


Upper left indication of  will be shown.

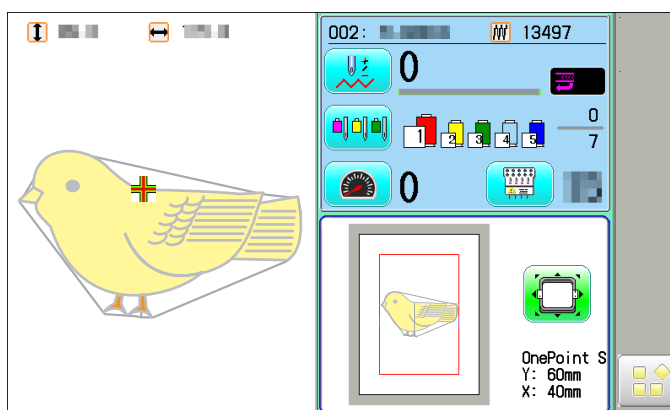
7. By  position of design can be moved.



8. Press .

The display returns to MENU.

Start sewing by pressing .



When One-point frame is used, Guide should be removed from Drive Frame.

When Cap frame is used, Guide should be installed on Drive Frame.

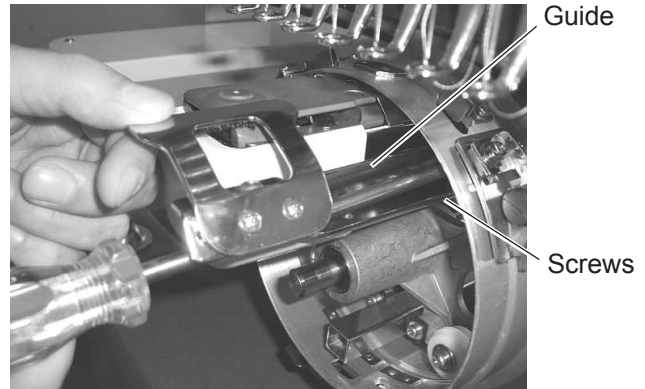
The following is process of installing and removing Guide.

■ When Long-One point frame is used, Guide should not be removed from Drive frame.

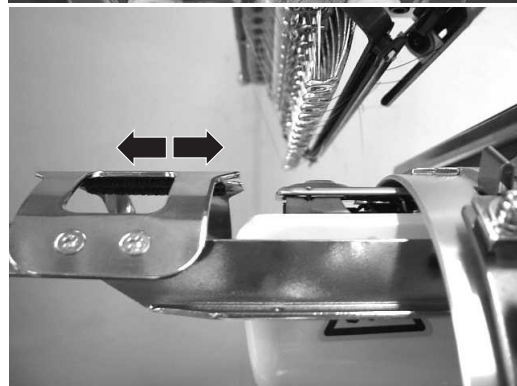
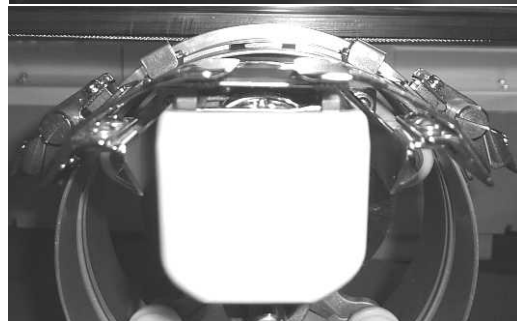
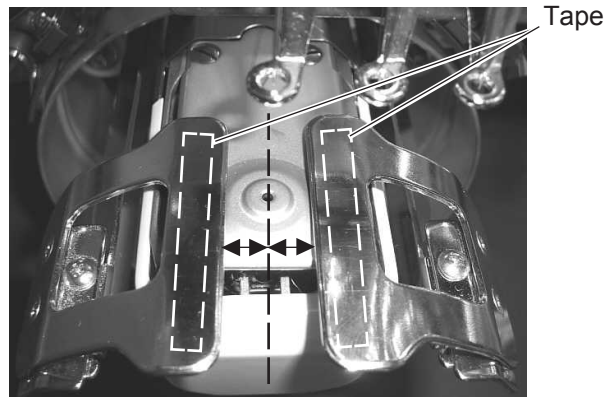
## Installing

1. Install Drive frame on machine.  
Refer to "[CAP FRAME]-[Installing and removing the cap drive frame]" in machine instruction manual.
2. Put Guide (right) one needle plate and fix Guide by 2 screws (M4x10).  
Then fix Guide (left) as well.

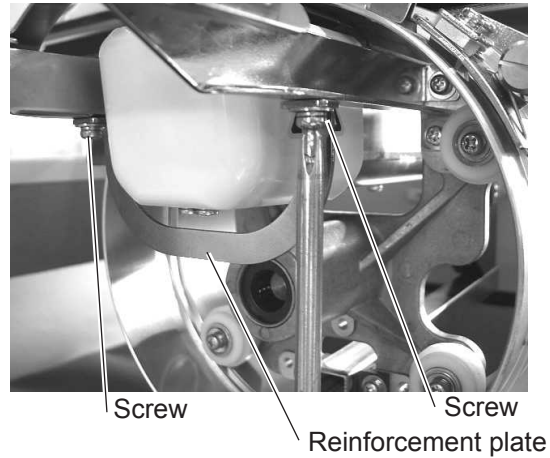
Please do not press Guide down too much and do not have clearance between pressure foot and tape under Guide.



3. After setting Guide, please confirm following points:  
Needle hole is located center position of right and left Guide.  
Height is equal for right and left Guide.  
Clearance of tape and needle plate is equal for right and left Guide.  
When frame is moved front and back, Guide is not hitting to needle plate.



4. Fix the Reinforcement plate (M4x6 2pcs).



Completed



## Removing

Please remove by reverse order of these step.  
When you take Guide out, you do not need to use Drive Frame.

# EXCHANGING SETTING PLATE

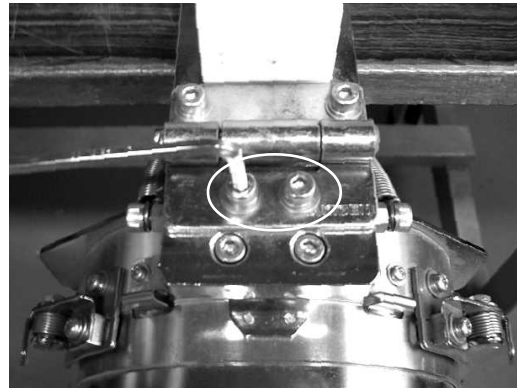
# 8-1

Cap Stretcher can be modified for One-point frame with exchanging setting plate.  
Contruaction of One-point frame setting base is same as Cap stretcher except shape of setting plate.

1. Place cap stretcher securely on a sturdy work bench.

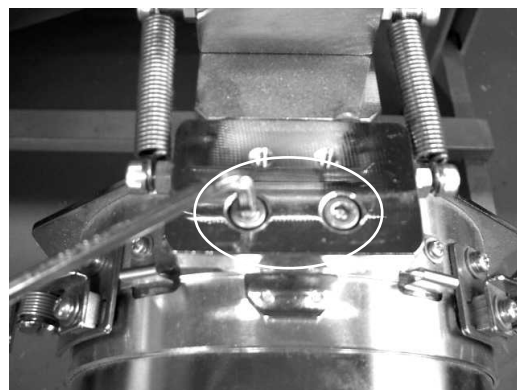


2. Loosen screws (M5x12, Spring washer, washer each 2pcs).

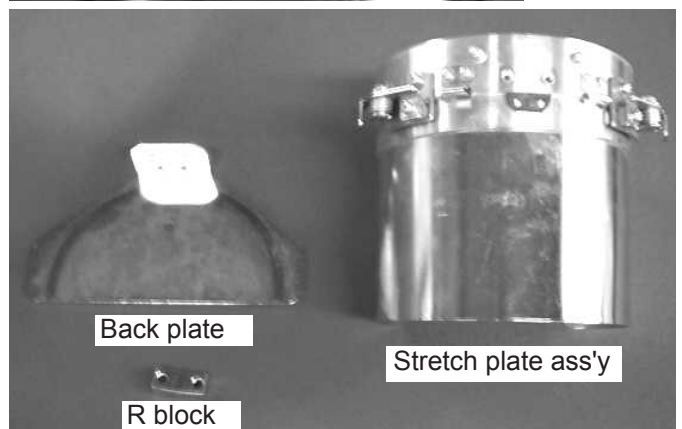


3. Loosen screws (M5x20 2pcs).

Please be careful that Stretch plate ass'y, R Block and Back plate will be taken out together from base .



These parts are taken from base as photo.



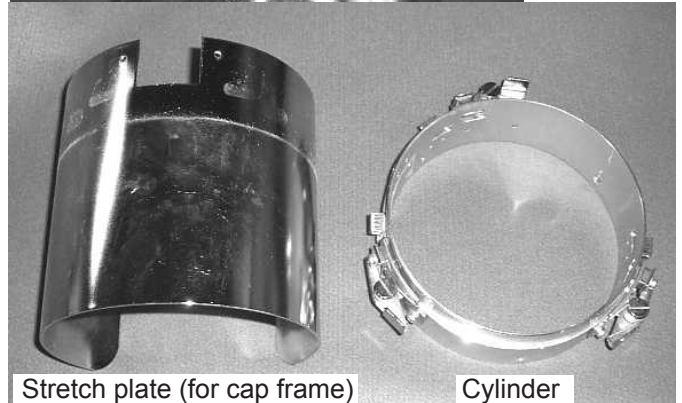


# EXCHANGING SETTING PLATE

8-2

- Loosen screw (M4x10 4pcs) and remove the Stretch plate.

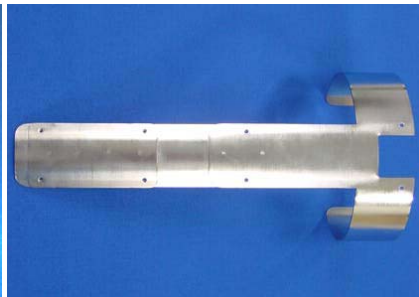
These parts are taken from Stretch plate ass'y as photo.



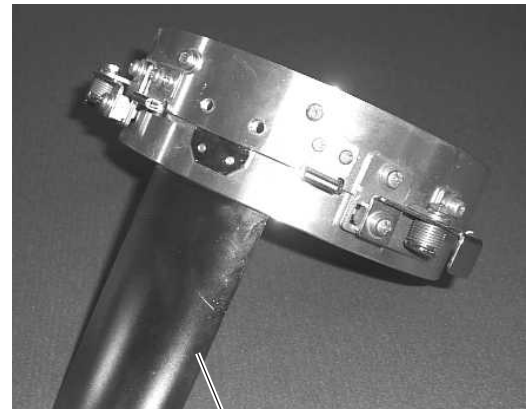
- Set One-point frame setting plate on Cylinder by screws (M4x10 4pcs).



for One-point frame



for Long one-point frame



One-point frame setting plate

- Set Setting plate ass'y, R block and Back plate by screws (M5x20 2pcs).

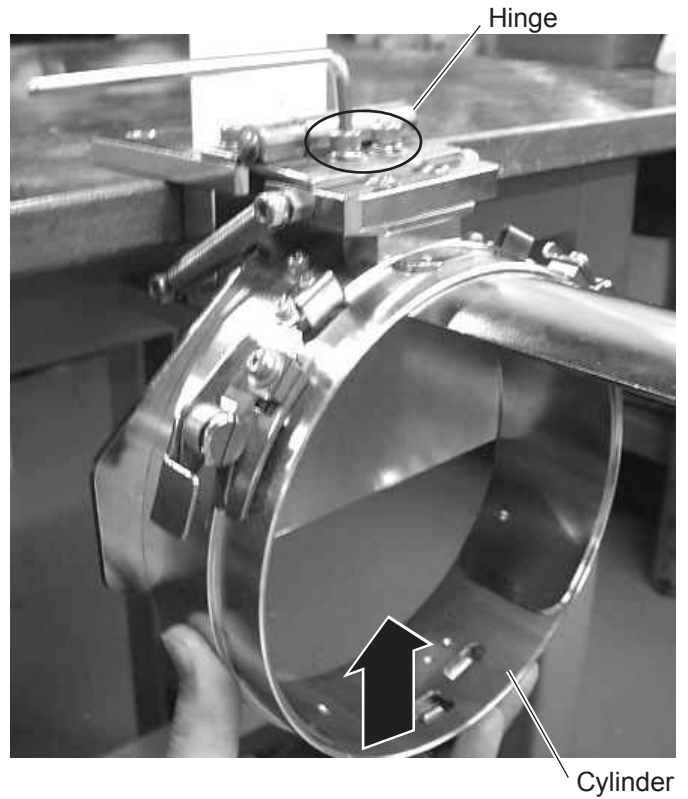


# EXCHANGING SETTING PLATE

8-3

7. Set Back Plate on Hinge by screws (M5x12, Spring washer and washer each 2pcs).

As springs pull Cylinder down, cylinder should be pushed up for screwing.

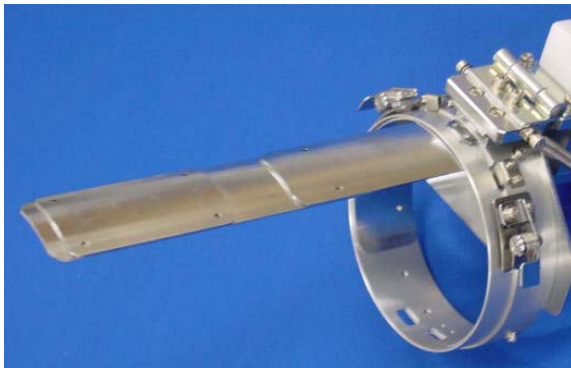


Finish operation

for One-point frame



for Long one-point frame

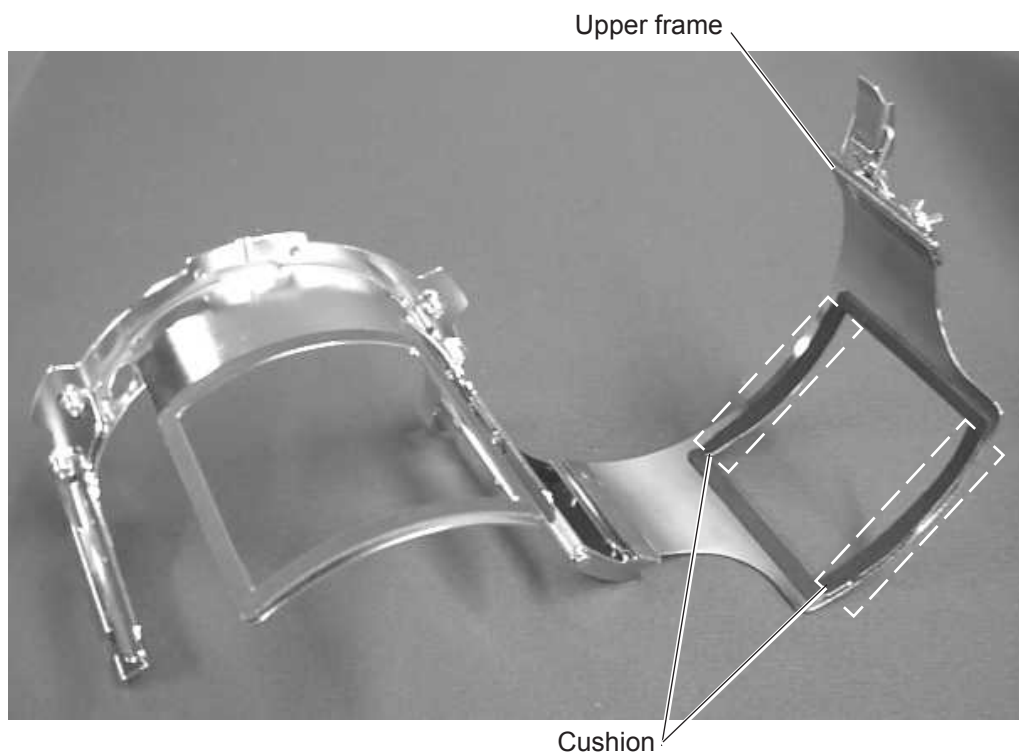


Same operation is required to modify from One-point frame setting base to Cap Stretcher.

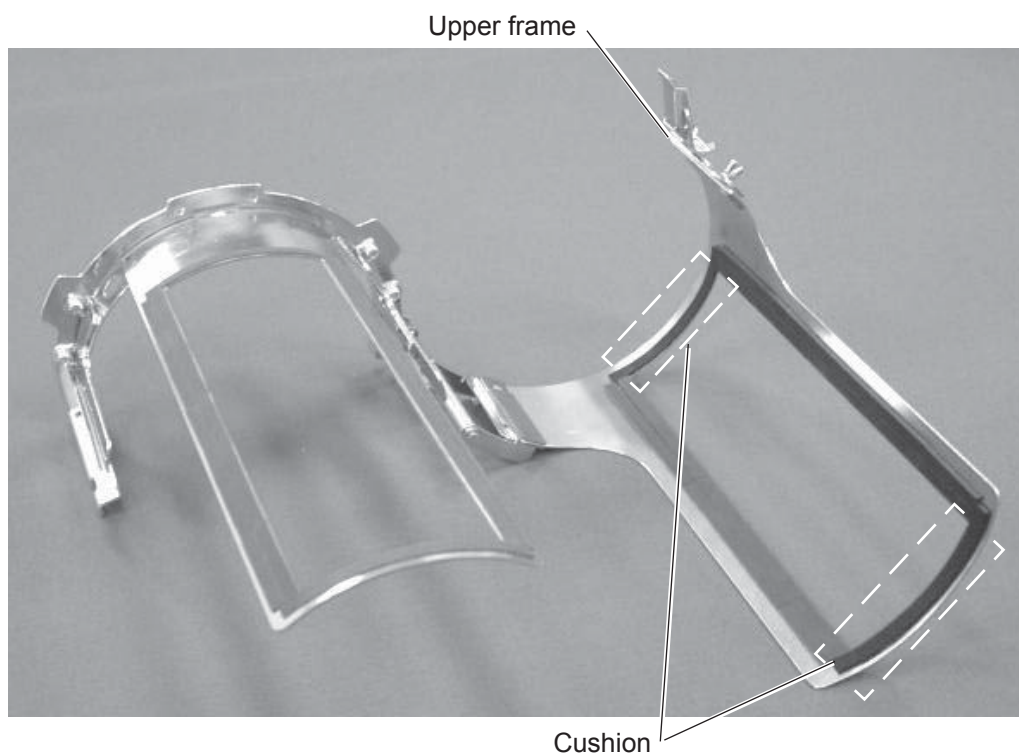
●Exchange Cushion

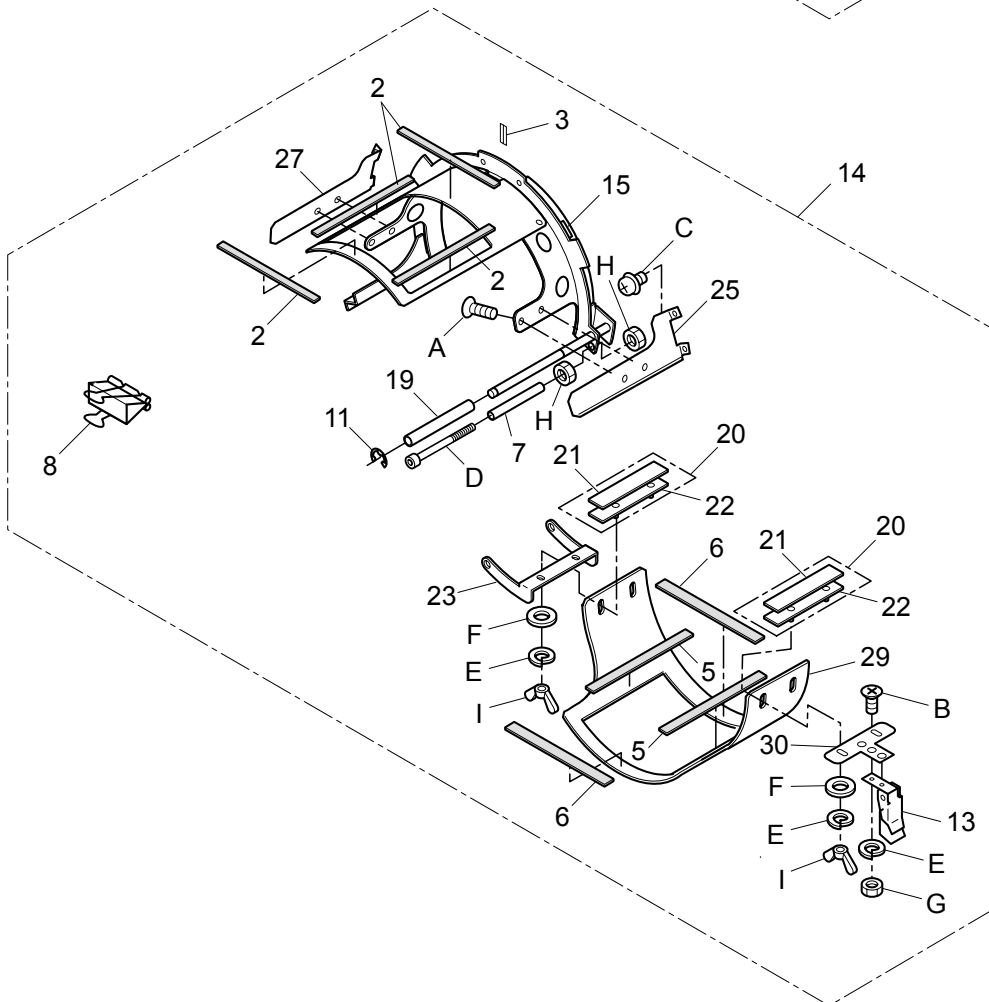
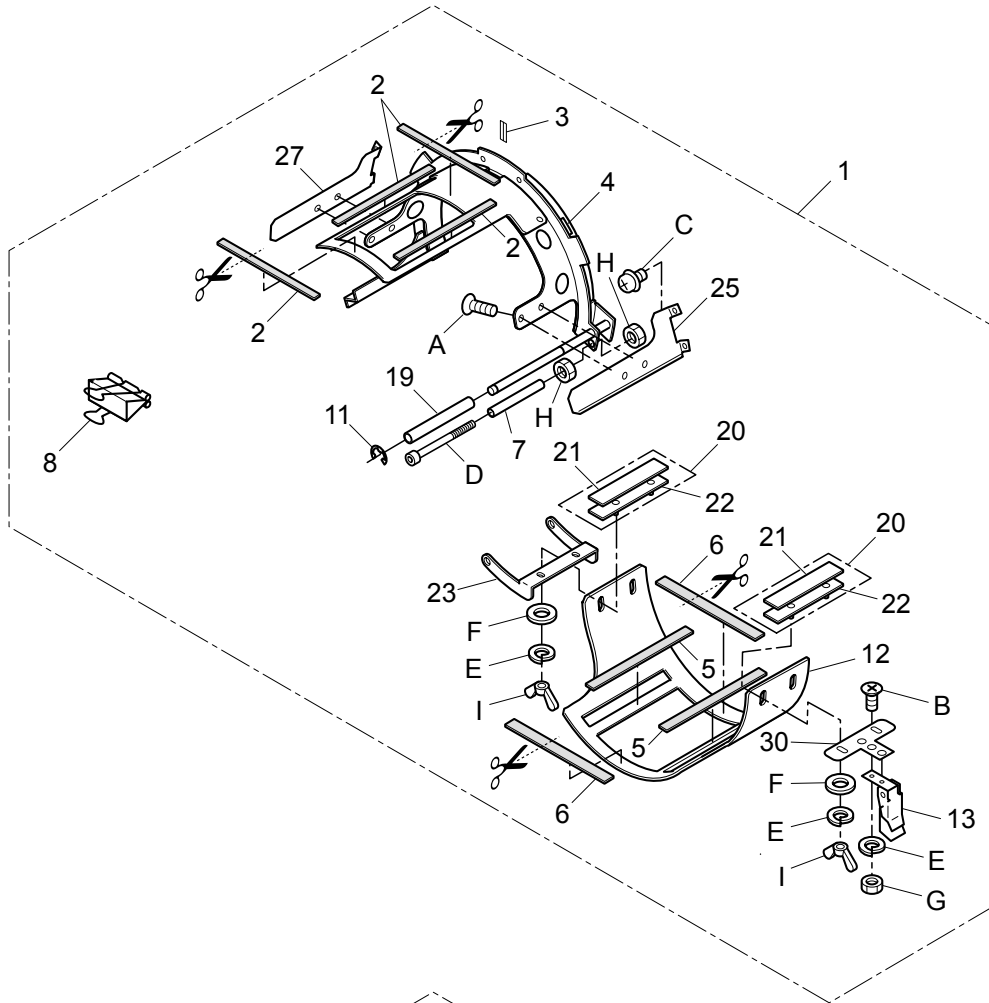
Cushion is located under the upper frame to hold fabric firmly.  
When cushion is worn or damaged, please exchange cushion.  
Please cut cushion to required length and attach under upper frame.

One-point frame



Long One-point frame

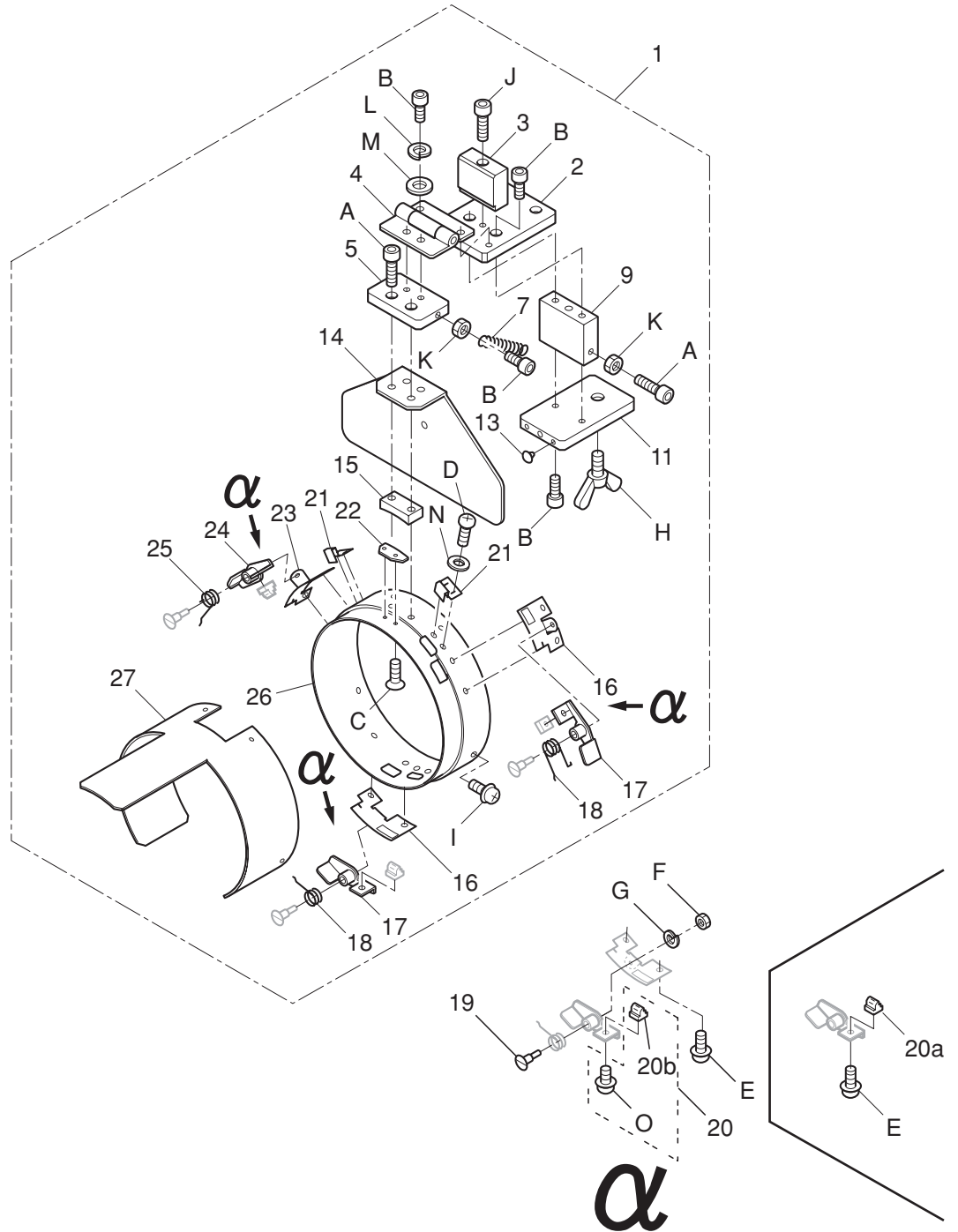




## ONE POINT FRAME ワンポイント枠 (取付枠)

10-2

組指図 Ass'y El't	部品番号 Parts No.	Parts Names	部品名	CRK101	備考 Note
1	FRA48010	One point frame S	ワンポイント枠 S		
2	FRA48091	Hold ruber under	下押さえゴム		
3	FRA44180	Cap marker	センターステッカー		
4	FRA48030	Hold frame S	取り付け枠 (小) セット		
5	FRA48101	Hold ruber upper	上押さえゴム		
6	FRA48130	Hold ruber cushion	上押さえクッション		
7	FRA48150	Spacer	スペーサー		
8	FRA48140	W-clip	ダブルクリップ		
11	FRA44170	E-ring	Eリング		
12	FRA48070	Upper frame S	上枠 (小)		
13	FRA44160	Latch	小型バチン錠		
14	FRA48020	One point frame L	ワンポイント枠 L		
15	FRA48040	Hold frame L	取り付け枠 (大) セット		
19	FRA46141	Spacer	スペーサー		
20	FRA46610	Side holder ass'y	サイド押えセット		
21	FRA46630	Side holder cushion	サイド押えゴム		
22	FRA46182	Side holder	サイド押え		
23	FRA46082	Bracket	ブラケット		
25	FRA46520	Side support (right)	サイド受け (右)		
27	FRA46530	Side support (left)	サイド受け (左)		
29	FRA48080	Upper frame L	上枠 (大)		
30	FRA46151	Latch bracket	バチン錠ブラケット		
A	SGAD03004	Flat head screw (phillips, M3x4)	十字穴付き皿小ねじ (M3x4)		
B	SGAD03006	Flat head screw (phillips, M3x6)	十字穴付き皿小ねじ (M3x6)		
C	SPDD04006	Pan head screw (phillips, M4x6)	十字穴付きなべ小ねじ (M4x6)		
D	SCAD04045	Hex socket head cap screw (M4x45)	六角穴付きボルト (M4x45)		
E	WSAD03000	Spring lock washer (M3)	ばね座金 (M3)		
F	WPAD03000	Plain washer (M3)	平座金 (M3)		
G	NHCD03000	Hex nut (M3)	六角ナット (M3)		
H	NHAD04000	Hex nut (M4)	六角ナット (M4)		
I	NWBK03000	Wing nut (M3)	ちょうナット (M3)		



# ONE POINT FRAME (SETTING BASE) ワンポイント枠 (段取台) 11-2

組指図 Ass'y El't	部品番号 Parts No.	Parts Names	部品名	FRL101	備考 Note
1	FRA48111	Setting base (for One point frame)	段取台組 (ワンポイント枠用)		
2	FRA44600	Base E	ブロック E		
3	FRA44610	Stopper A	ストッパー A		
4	FRA44581	Hinge	平蝶番		
5	FRA44590	Base D	ブロック D		
7	FRA44620	Tension coil spring	保持ばね		
9	FRA44562	Base B	ブロック B		
11	FRA44571	Base C	ブロック C		
13	FRA44630	Cushion	クッションゴム		
14	FRA44531	Back plate	バックプレート		
15	FRA44541	R block	Rブロック		
16	FRA43591	Lever bracket (right)	レバーブラケット (右)		
17	FRA43560	Hold lever ass'y (right)	保持レバー (右) 組		
18	FRA43620	Torsion coil spring (right)	ねじりコイルバネ (右)		
19	FRA43611	Support pin	段付きピン		
20a	FRA43602	Lock pin	ロックピン		
20b	FRA43603	Lock pin	ロックピン		
20	FRAU43603	Lock pin set This can be substituted for "20a".	ロックピン (組) "20a" の代用可		
21	FRA43550	Spring	板ばね		
22	FRA43542	Center guide	センターガイド		
23	FRA43651	Lever bracket (left)	レバーブラケット (左)		
24	FRA43630	Hold lever ass'y (left)	保持レバー (左) 組		
25	FRA43660	Torsion coil spring (left)	ねじりコイルバネ (左)		
26	FRA44511	Cylinder	保持リング		
27	FRA48120	Stretch plate (for One point frame)	布張り板 (ワンポイント枠用)		
A	SCAD05020	Hex socket head cap screw (M5x20)	六角穴付きボルト (M5x20)		
B	SCAD05012	Hex socket head cap screw (M5x12)	六角穴付きボルト (M5x12)		
C	SGAD03005	Flat head screw (phillips, M3x5)	十字穴付き皿小ねじ (M3x5)		
D	SPAD03005	Pan head screw (phillips, M3x5)	十字穴付きなべ小ねじ (M3x5)		
E	SPDD04008	Pan head screw (phillips, M4x8)	十字穴付きなべ小ねじ (M4x8)		
F	NHCD04000	Hex nut (M4)	六角ナット (M4)		
G	WSAD04000	Spring lock washer (M4)	ばね座金 (M4)		
H	SWAK10020	Wing bolt (M10x20)	ちょうボルト (M10x20)		
I	SPDD04010	Pan head screw (phillips, M4x10)	十字穴付きなべ小ねじ (M4x10)		
J	SCAD05035	Hex socket head cap screw (M5x35)	六角穴付きボルト (M5x35)		
K	NHAD05000	Hex nut (M5)	六角ナット (M5)		
L	WSAD05000	Spring lock washer (M5)	ばね座金 (M5)		
M	WPAD05000	Plain washer (M5)	平座金 (M5)		
N	WPAD03000	Plain washer (M3)	平座金 (M3)		
O	SPDD04006	Pan head screw (phillips, M4x6)	十字穴付きなべ小ねじ (M4x6)		

# HCH\*, HCS\*, HCD\*, HCU\*

## Shoe Clamp Frame

# INSTRUCTION MANUAL

Program Ver. \*1.60 ~

HappyJapan Inc.

FCu701-6

## IMPORTANT SAFETY INSTRUCTIONS

0



- Use this Manual together with Instruction Manual of embroidery machine for mounting this appliance and for operating.
- Use this appliance only for its intended use as described in this manual. Use only attachments recommended by the manufacturer as contained in this manual.
- Keep fingers away from all moving parts. Special care is required around the sewing machine needle.
- Do not pull or push fabric while stitching. It causes damage.
- Do not modify this appliance.

**SAVE THESE INSTRUCTIONS**



BASIC INFORMATION OF SHOES CLAMP FRAME ....	1-1
ACCESSORIES.....	1-2
ADJUSTMENT OF EMBROIDERY AREA.....	2-1
ADJUSTMENT OF UPPER ARM .....	2-2
INSTALLING THE FRAME .....	3-1
HOOPING SHOES	
Side of shoes.....	4-1
Tongue.....	4-3
STARTING TO EMBROIDER .....	5-1
ETC.	
EXCHANGE SPONGE AND SHEET.....	6-1
PARTS LIST .....	7-1

# BASIC INFORMATION OF SHOE CLAMP FRAME 1-1

The types of shoe clamp frame are described below.  
Use correct type of shoe frame for your embroidery machine.



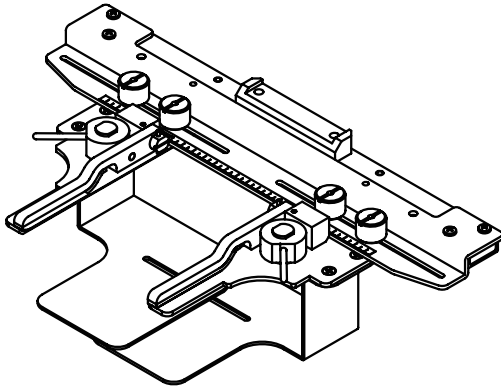
## CAUTION: To avoid problems.

To use shoe clamp frame, select "Special frame" from frame selection menu.  
Please note that the following functions will be canceled at "Special Frame" mode.

- \* Frame confirmation (embroidery area of frame)
- \* Auto stop function when frame movement exceeds the carriage limit.

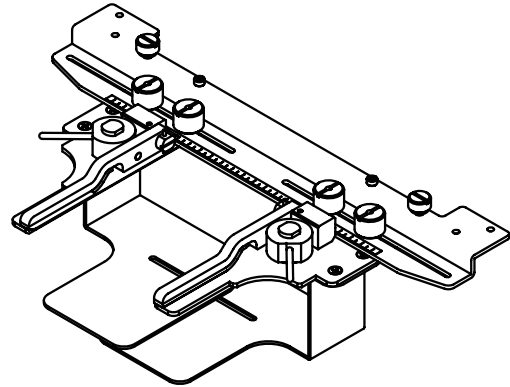
FRA21D0

Shoes clamp frame ass'y (for HCH\*, HCS\*)



FRA21D1

Shoes clamp frame ass'y (for HCD\*, HCU\*)



## ACCESSORIES

1-2

FRA21161 Sponge (2 pcs)

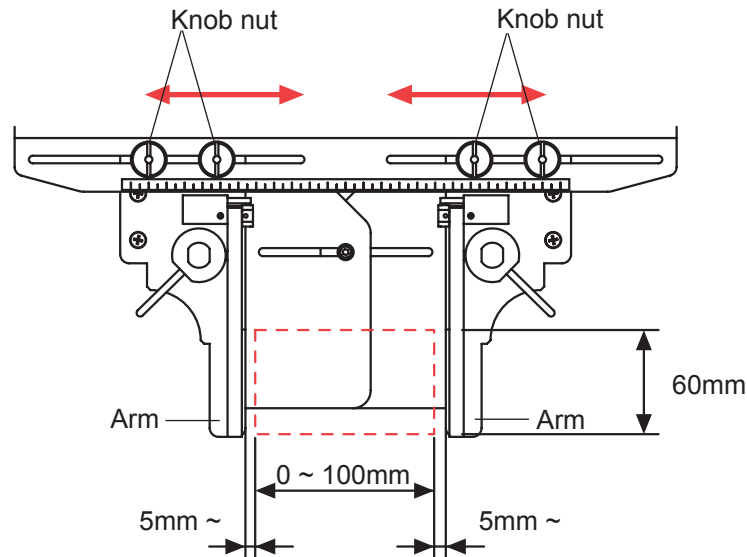
FRA21171 Sheet (2 pcs)  
(packed with frame)



## ADJUSTMENT OF EMBROIDERY AREA

2-1

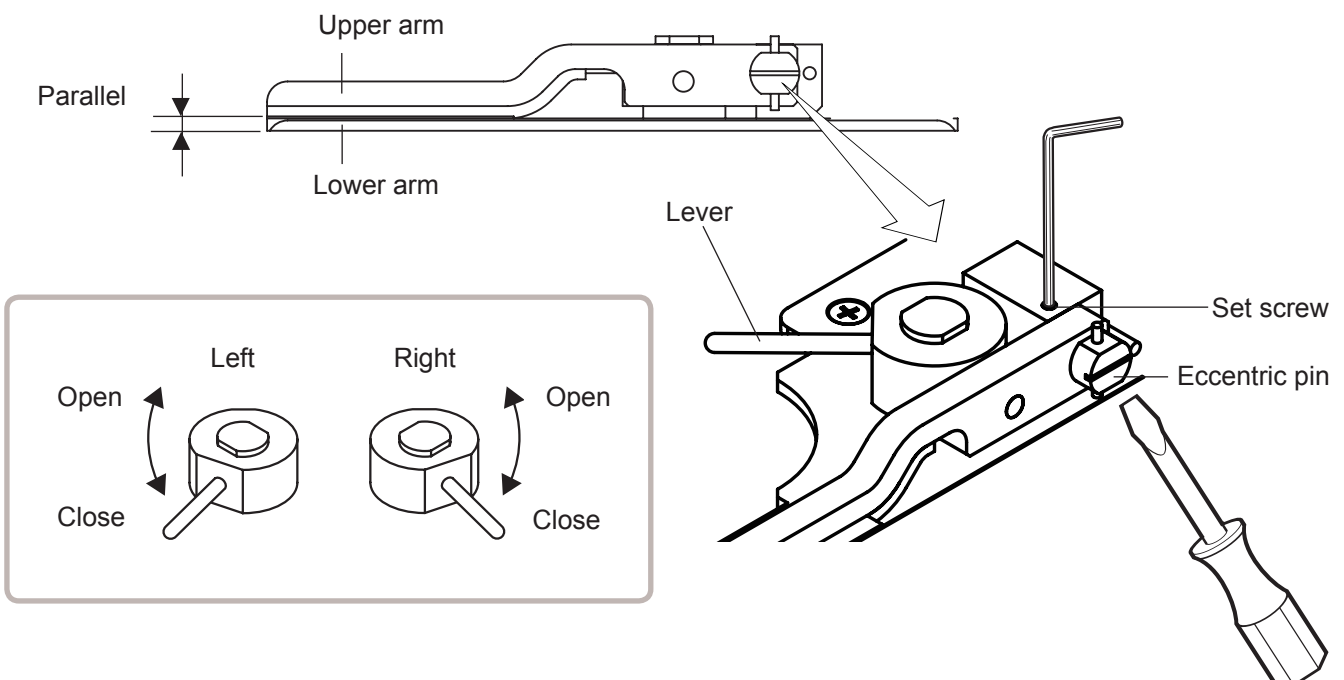
Adjust width of the upper arm to meet size of tongue and embroidery design.  
Width of the arm should have enough margins for embroidery area.  
Loosen both side knob nuts for adjustment of arm.  
Tighten all knob nuts after adjustment.



## ADJUSTMENT OF UPPER ARM

2-2

Please note that basically the upper arm and the lower arm should be parallel at locking position.  
In case the thickness of the material is uneven, use adjusting set screw and eccentric pin to change angle of the upper arm to give holding pressure evenly.



# INSTALLING THE FRAME

# 3-1

When you use Shoe clamp frame or Side clamp frame, please make machine setting according to frame type selected.



## CAUTION: To avoid problems.

The machine and / or frame may be damaged if the incorrect frame settings are used.

1. Turn on the power switch.

Indicates the selected frame.



Selected frame



2. In case required "Special frame" is already selected, press the **Next** and jump to operation no.4.

In case selected frame type is not "Special frame", press .



3. Select "Special frame".



4. Press **Next**.

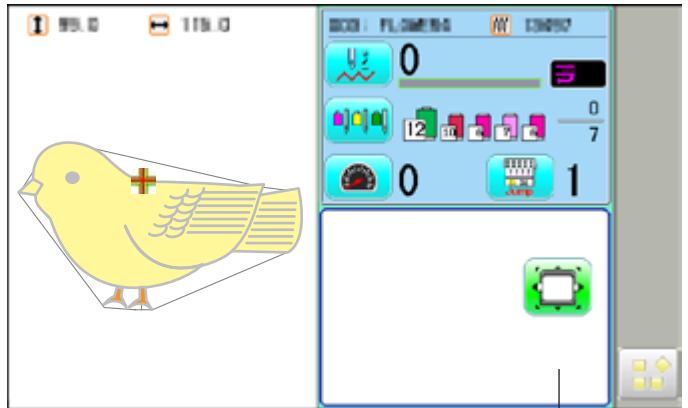


# INSTALLING THE FRAME


5. Press  .

Indication of frame type disappears.  
It means that "Special frame" is selected.

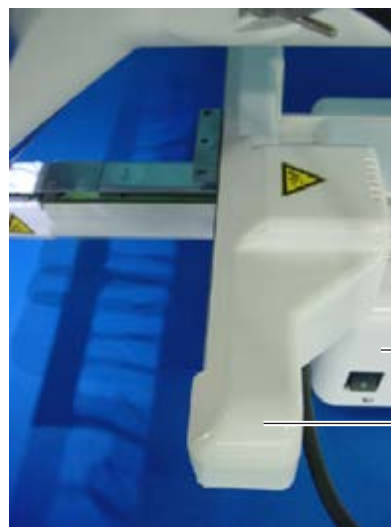
■ When you need to change from Special frame to other type of frame, please power machine off and start again.  
Without re-starting machine, machine will move incorrectly.



Frame indication disappears

6. Press  and move the carriage to the position

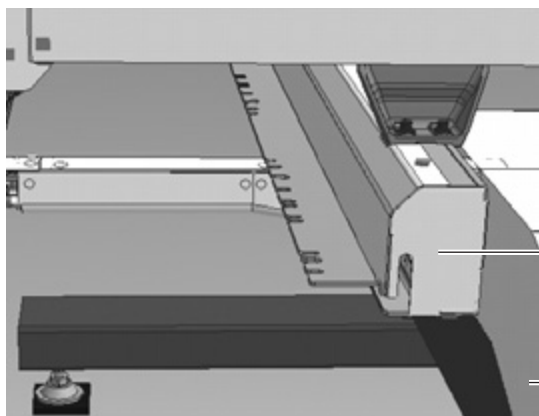
shown by press



HCH\*, HCS\*

Machine

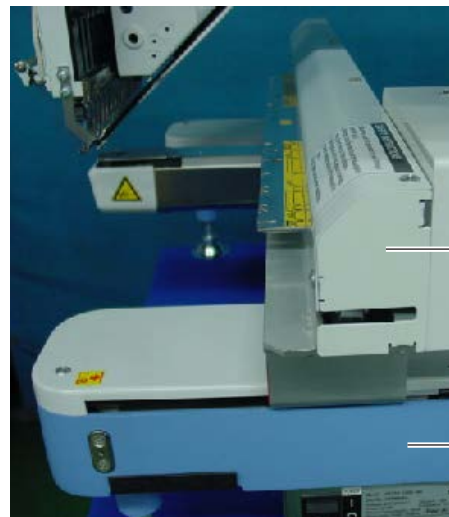
Carriage



HCU\*

Carriage

Machine



HCD2\*

Carriage

Machine

# INSTALLING THE FRAME

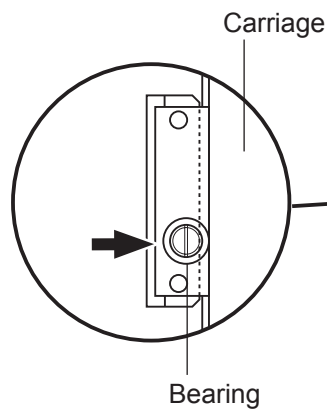
7. Insert shoe clamp frame to below the fixing base of carriage by sliding on bed.

HCH\*, HCS\*

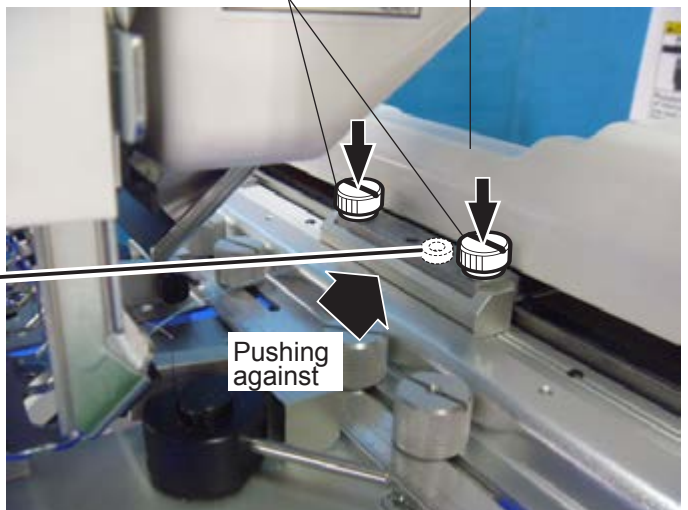
Fixing base



Fix knob screws as hitting the bearing against the carriage while pressing the shoe clamp frame to the carriage.

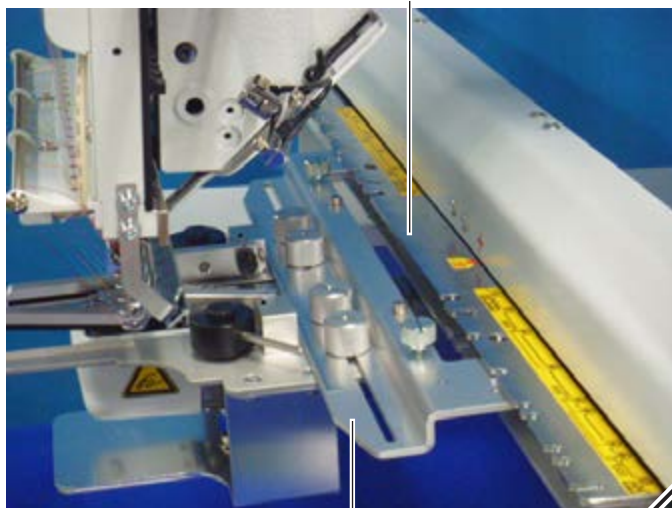


Knob screw Shoes clamp frame Carriage



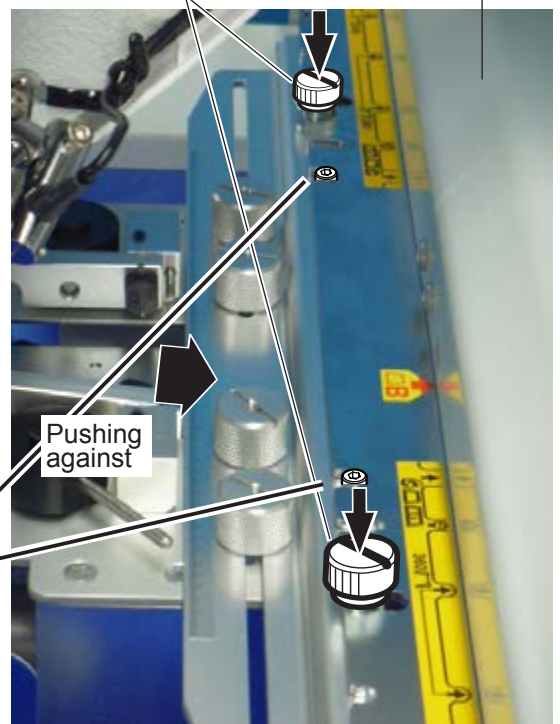
HCD\*, HCU\*

Fixing base

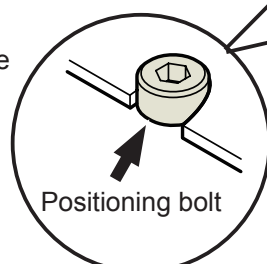


Knob screw

Carriage



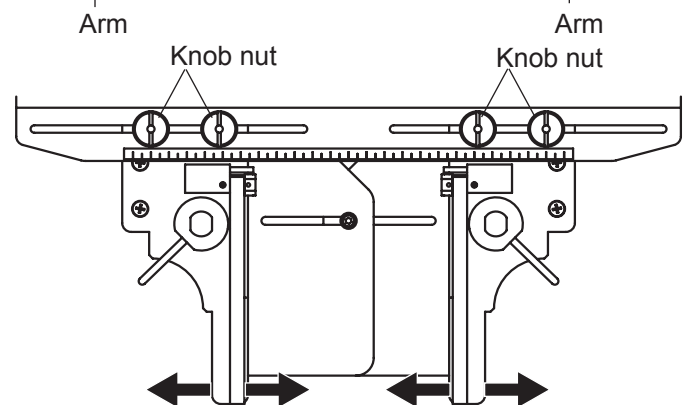
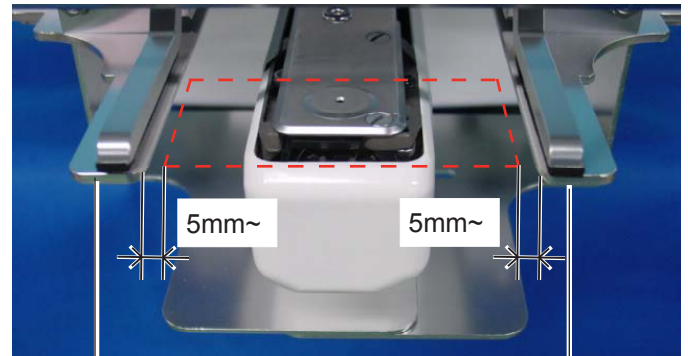
Shoes clamp frame



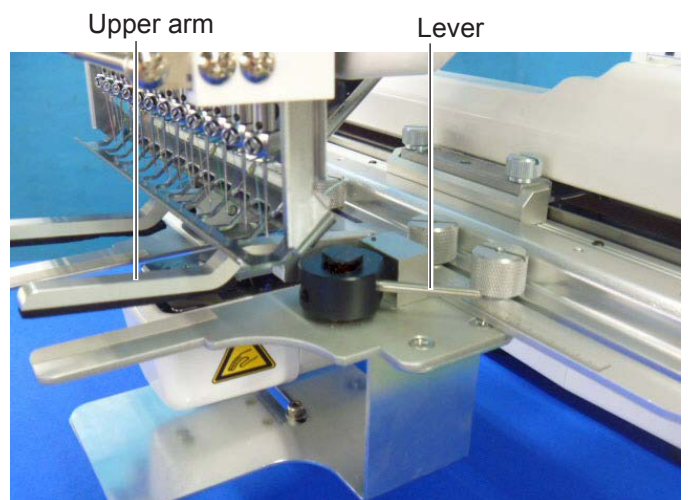
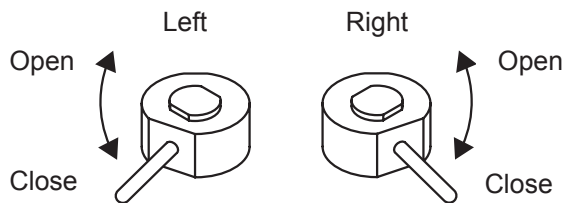
## ●Side of shoes

The following is an example to make embroidery on side of sports shoe.

1. Adjust width of the arm to meet size of material and embroidery design.  
Width of the arm should have enough margins for embroidery area.  
Loosen both side knob nuts for adjustment of arm.  
Tighten all knob nuts after adjustment.



2. Turn right and left lever to open the upper arm.

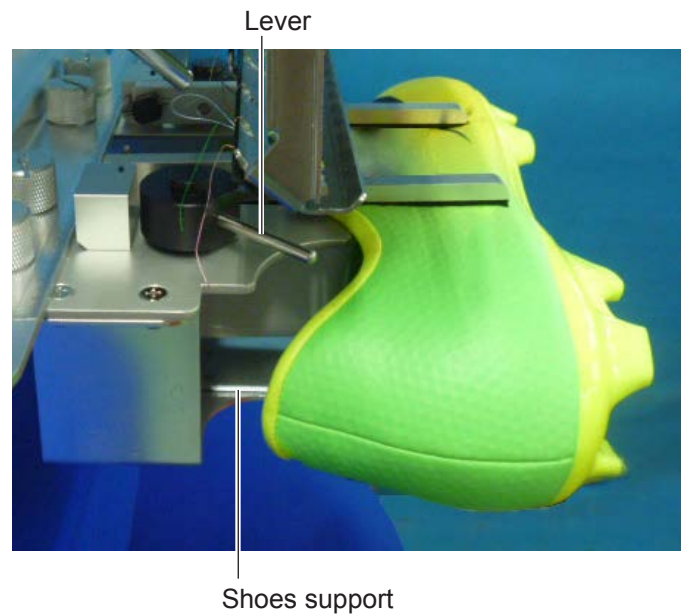
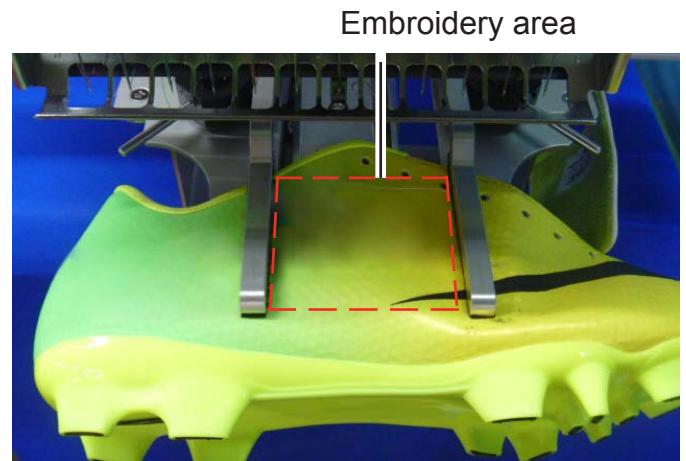


3. Remove shoestring.  
Pull tongue toward outside.



4. Turn right and left lever, then the shoe will be locked.  
Please make sure that the material inside of embroidery area is set flat.
- Please also check that no hard material like eyelet is located in the embroidery area.

Shoes support should be inserted in the shoe.

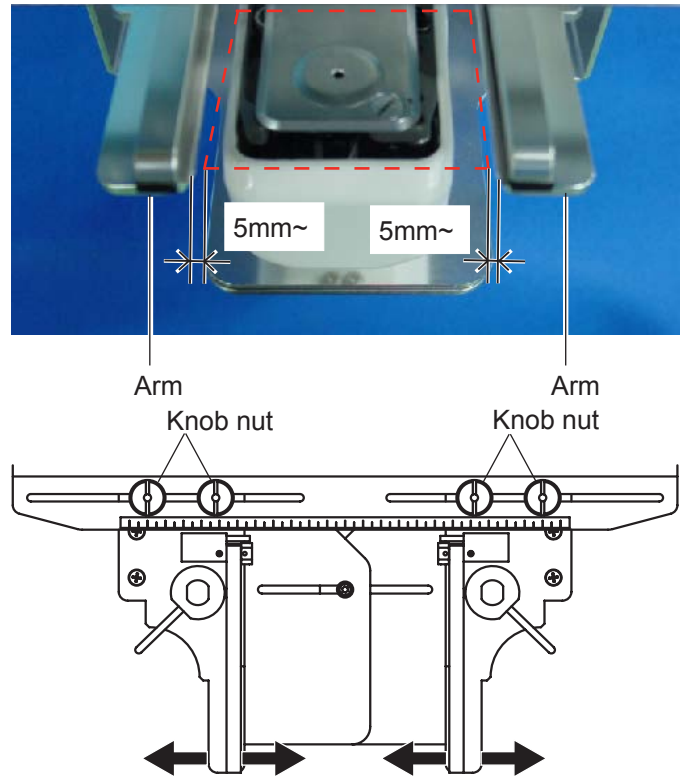




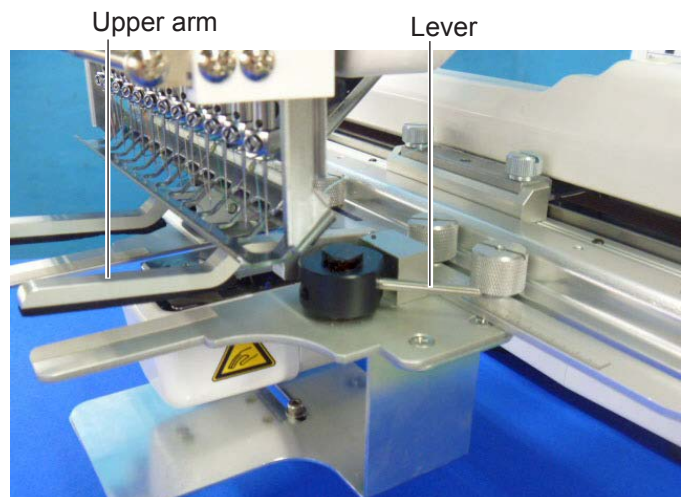
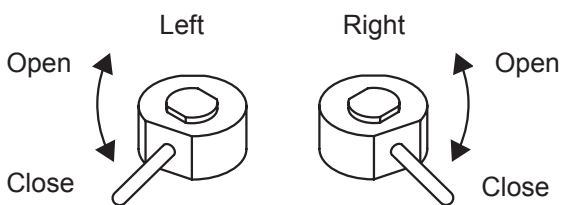
## ●Tongue

The following is an example to make embroidery on tongue of sports shoe.

- Adjust width of the upper arm to meet size of tongue and embroidery design. Width of the arm should have enough margins for embroidery area. Loosen both side knob nuts for adjustment of arm. Tighten all knob nuts after adjustment.



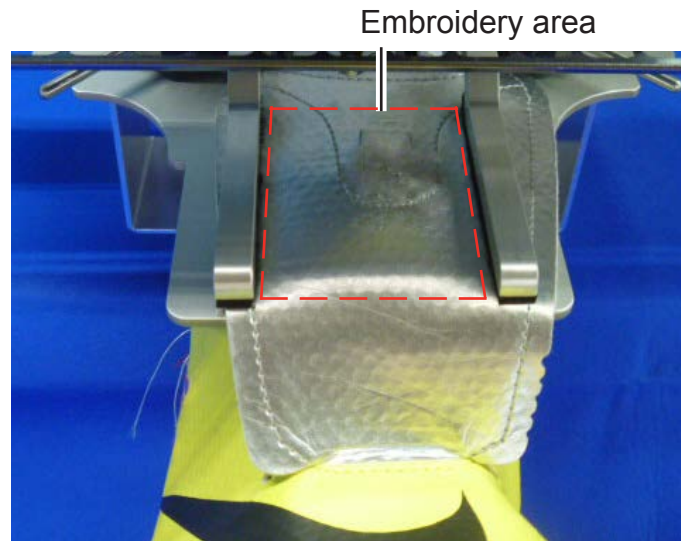
- Turn right and left lever to open the upper arm.



- Remove shoestring. Pull tongue toward outside.

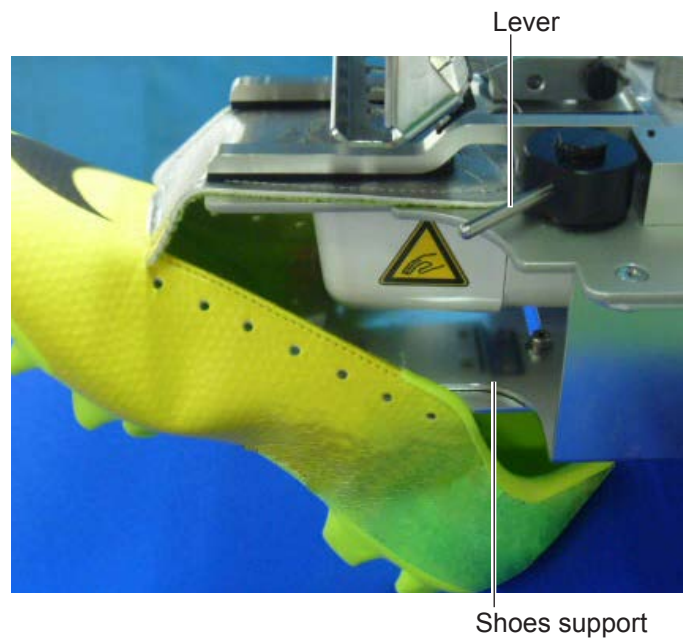


4. Turn right and left lever, then the shoe will be locked.  
Please make sure that the material inside of embroidery area is set flat.
- Please also check that no hard material like eyelet is located in the embroidery area.

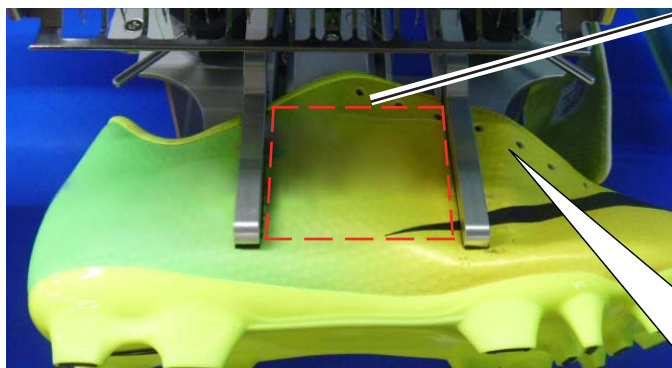


Shoes support should be inserted in the shoe.

In case you cannot install shoes support due to shape of the shoe, hold the body of the shoe by hand while making embroidery to prevent the tongue from coming off.

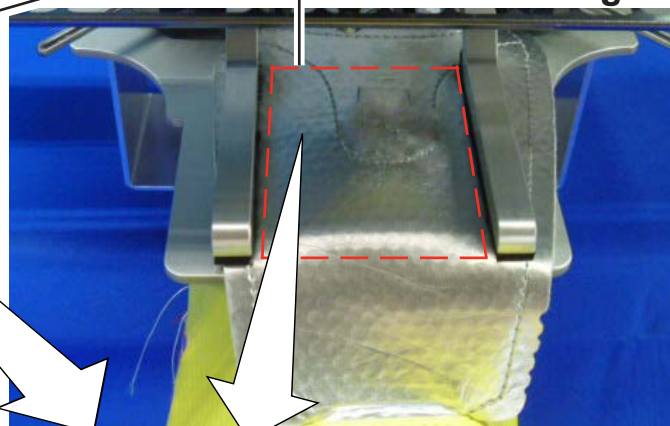



## Side of shoes



Embroidery area

## Tongue




1. Press  and move the frame to the original


point with the




2. Press



Press , and the embroidering frame moves for the design trace. You can confirm outline trace and the position of the design.

Press , and trace is stopped.

Go on to step 4 if you want to start embroidering without tracing.

3. Press  after the trace is completed.

The embroidering frame has moved to the first stitch point of the pattern.

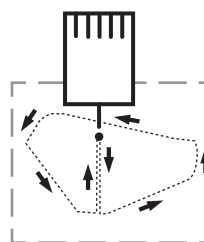
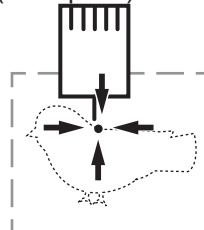
4. Press .

The embroidery will start.

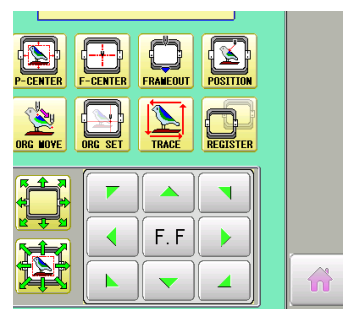
5. After embroidering your design is complete, show ">>End" and the machine will stop.

The embroidery frame returns to the original point automatically if the "Auto origin" function has been activated.

- : Original point (Start point)



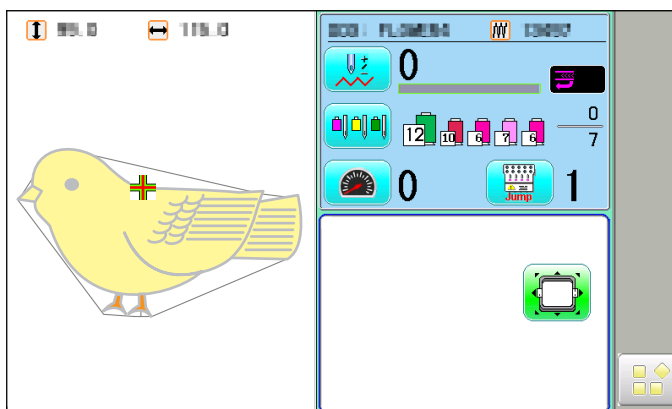
You can confirm the outline and position of design.



Backward only when pressing Forward only when pressing

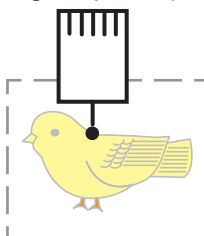


Pause button



>>End

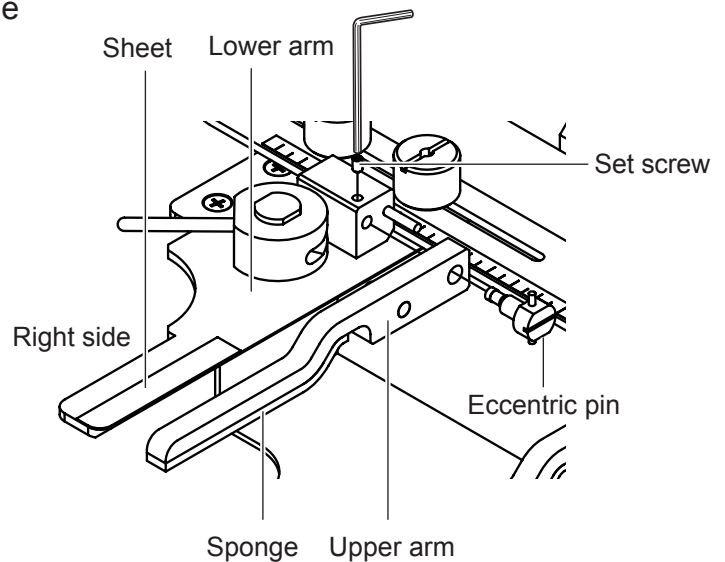
- : Original point (Start point)



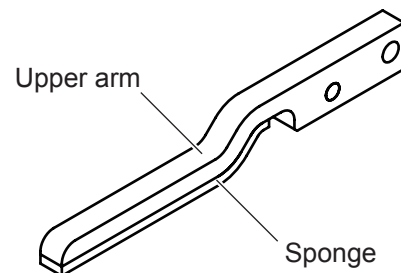
## ● EXCHANGE SPONGE AND SHEET

Sponge and sheet are located under the upper arm and on the lower arm to hold fabric firmly. When sponge or sheet are worn or damaged, please exchange sponge or sheet.

1. Remove the set screw and disassemble the eccentric pin.
2. Remove the upper arm.
3. Remove the sponge or sheet from the upper arm or the lower arm.

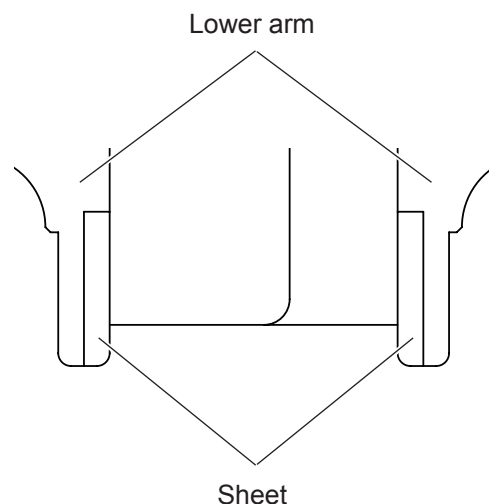


4. Attach the sponge to fit with the edge of the upper arm as shown.



5. Attach the sheet to fit with the edges of the lower arm as shown.

Cut to fit around the corner.

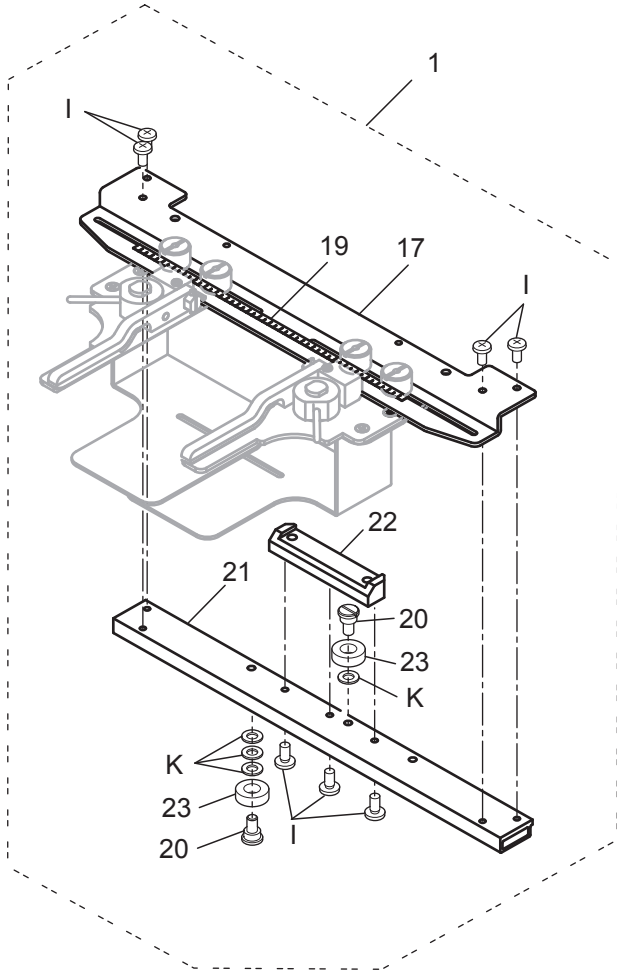


4. In the reverse order of disassembling, fix the upper arm, by screw.

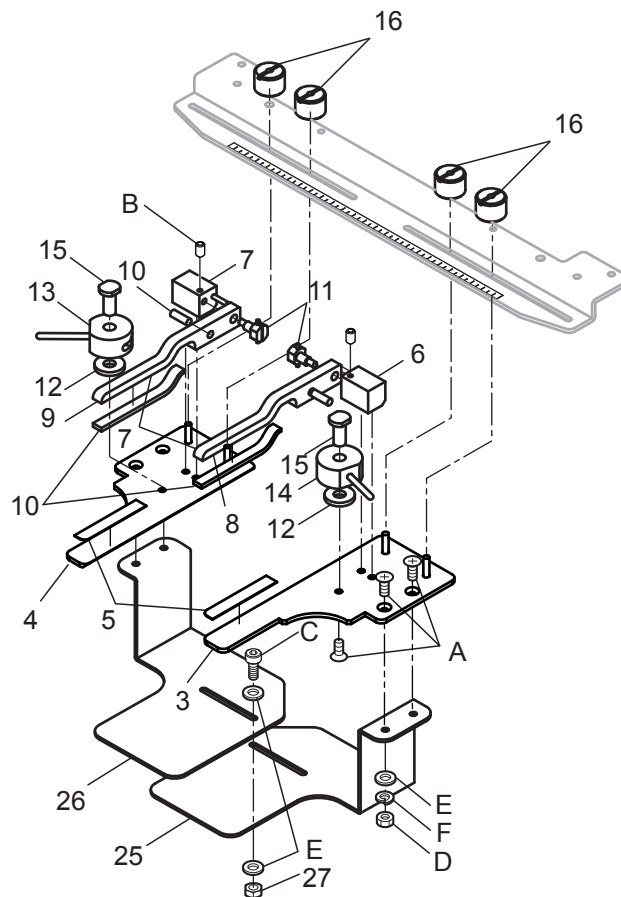
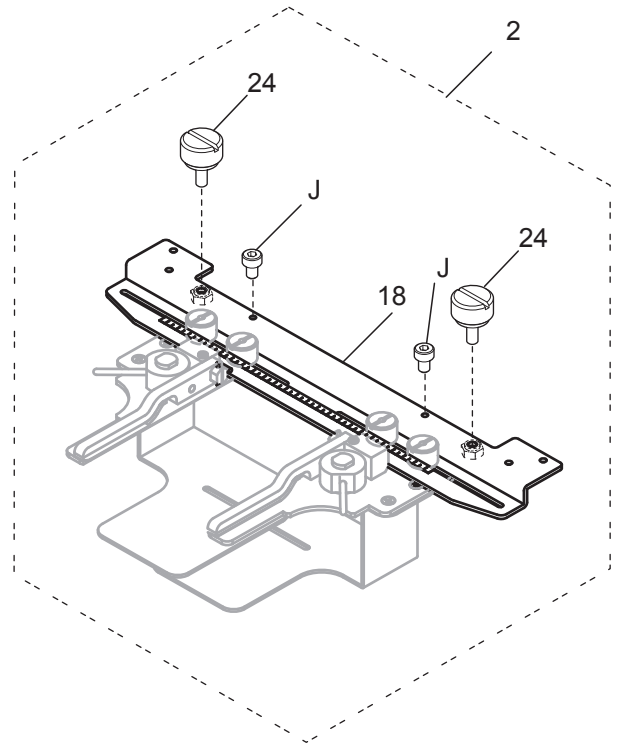
After fix the upper frame, adjust the upper frame in accordance with "ADJUSTMENT OF UPPER ARM 2-2".



## HCH\*, HCS\*



## HCD\*, HCU\*



指図 Ass'y	部品番号 El't Parts No.	部品名 Parts Names	FCPA15 備考 Note
	1 FRA21D0	Shoes frame ass'y (for HCH*, HCS*)	靴枠組(HCH*, HCS*用)
	2 FRA21D1	Shoes frame ass'y (for HCD*, HCU*)	靴枠組(HCD*, HCU*用)
	3 FRA21F00	Lower arm (right) ass'y	下アーム(R)組
	4 FRA21F10	Lower arm (left) ass'y	下アーム(L)組
	5 FRA21171	Sheet	滑り止めシート
	6 FRA21F40	Fulcrum block (right) ass'y	支点ブロック(R)組
	7 FRA21F50	Fulcrum block (left) ass'y	支点ブロック(L)組
	8 FRA21F70	Upper arm (right) ass'y	上アーム(R)組
	9 FRA21F80	Upper arm (left) ass'y	上アーム(L)組
	10 FRA21161	Sponge	滑り止めスポンジ
	11 FRA21F60	Eccentric pin ass'y	偏心ピン組
	12 MPZ04730	Washer	金属ワッシャ
	13 FRA21F20	Cam (right) ass'y	溝カム(R)組
	14 FRA21F30	Cam (left) ass'y	溝カム(L)組
	15 FRA21340	Shaft	シャフト
	16 FRA21102	Knob nut	ノブナット
	17 FRA21152	Connecting plate	靴枠連結板
	18 FRA21B51	Connecting plate ass'y	靴枠連結板組
	19 FRA21200	Scale sticker A (250mm)	メモリテープA
	20 HCB40041	Screw	ベアリング止めネジ
	21 HCB40121	Arm	連結アーム
	22 HCB40132	Bracket	取付け板
	23 MPB00250	Bearing (L1680ZZ)	ミニチュアベアリング
	24 HCD37092	Knob screw	ノブネジA
	25 FRA21082	Shoes support (right)	靴受け(R)
	26 FRA21092	Shoes support (left)	靴受け(L)
	27 MPZ04260	U-nut	Uナット M4
A	SGAK04010	Flat head screw (phillips, M4x10)	十字穴付き皿小ねじ (M4×10)
B	SSAA03005	Hex socket screw (M3x5)	六角穴付き止めねじ (M3×5)
C	SCAD04010	Hex socket head cap screw (M4x10)	六角穴付きボルト (M4×10)
D	NHAD04000	Hex nut (M4)	六角ナット (M4)
E	WPAD04000	Plain washer (M4)	平座金 (M4)
F	WSAD04000	Spring lock washer (M4)	ばね座金 (M4)
I	SBAK04008	Bind head screw (phillips, M4x8)	十穴付きバインド小ねじ (M4×8)
J	SCAD04006	Hex socket head cap screw (M4x6)	六角穴付きボルト (M4×6)
K	WPAD05000	Plain washer (M5)	平座金 (M5)

# HCH\*, HCS\*, HCD\*, HCU\*

## Side Clamp Frame

# INSTRUCTION MANUAL

Program Ver. \*1.60 ~

HappyJapan Inc.

FCU701-7

## IMPORTANT SAFETY INSTRUCTIONS

0



- Use this Manual together with Instruction Manual of embroidery machine for mounting this appliance and for operating.
- Use this appliance only for its intended use as described in this manual. Use only attachments recommended by the manufacturer as contained in this manual.
- Keep fingers away from all moving parts. Special care is required around the sewing machine needle.
- Do not pull or push fabric while stitching. It causes damage.
- Do not modify this appliance.

**SAVE THESE INSTRUCTIONS**



BASIC INFORMATION OF SIDE CLAMP FRAME ..	1-1
ACCESSORIES.....	1-2
ADJUSTMENT OF EMBROIDERY AREA.....	2-1
ADJUSTMENT OF UPPER ARM .....	2-2
INSTALLING THE FRAME .....	3-1
HOOPING MATERIAL .....	4-1
STARTING TO EMBROIDER .....	5-1
ETC.	
EXCHANGE SPONGE AND SHEET.....	6-1
PARTS LIST .....	7-1

# BASIC INFORMATION OF SIDE CLAMP FRAME 1-1

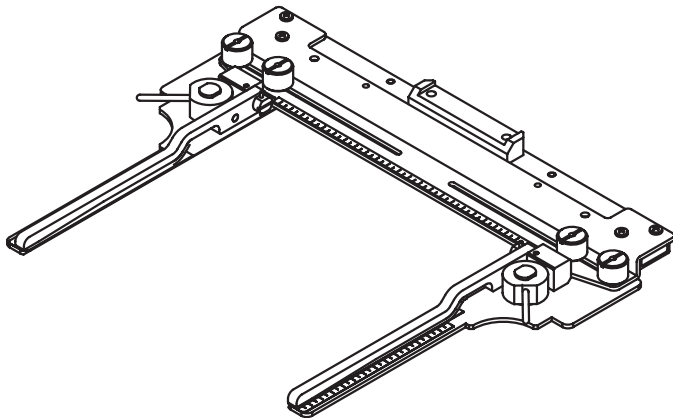
The types of side clamp frame are described below.  
Use correct type of side clamp frame for your embroidery machine.



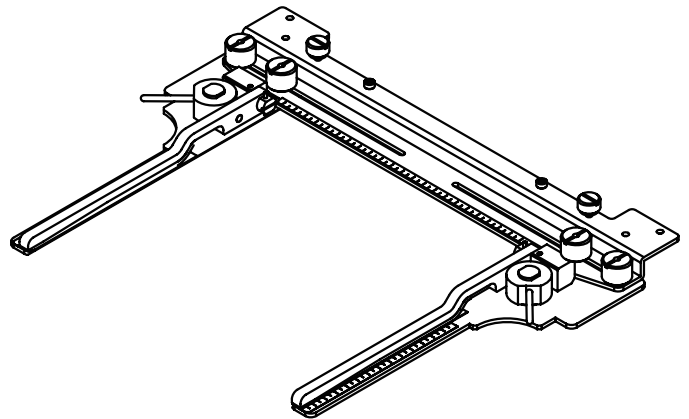
## CAUTION: To avoid problems.

To use side clamp frame, select "Special frame" from frame selection menu.  
Please note that the following functions will be canceled at "Special Frame" mode.  
\* Frame confirmation (embroidery area of frame)  
\* Auto stop function when frame movement exceeds the carriage limit.

FRA21G0  
Side Clamp Frame (for HCH\*, HCS\*)



FRA21G1  
Side Clamp Frame (for HCD\*, HCU\*)



## ACCESSORIES

1-2

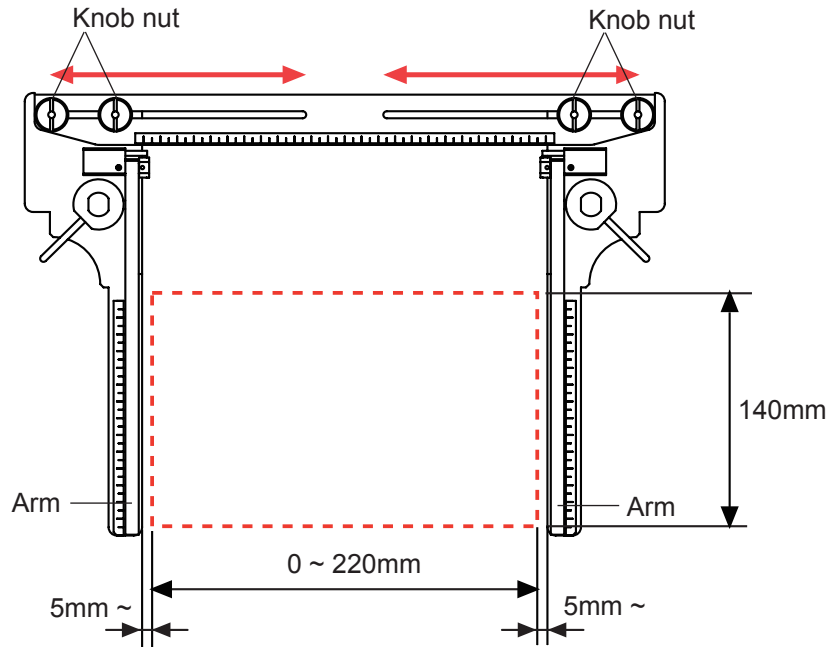
FRA21181 Sponge (2 pcs)  
FRA21191 Sheet (2 pcs)  
(packed with frame)



# ADJUSTMENT OF EMBROIDERY AREA

2-1

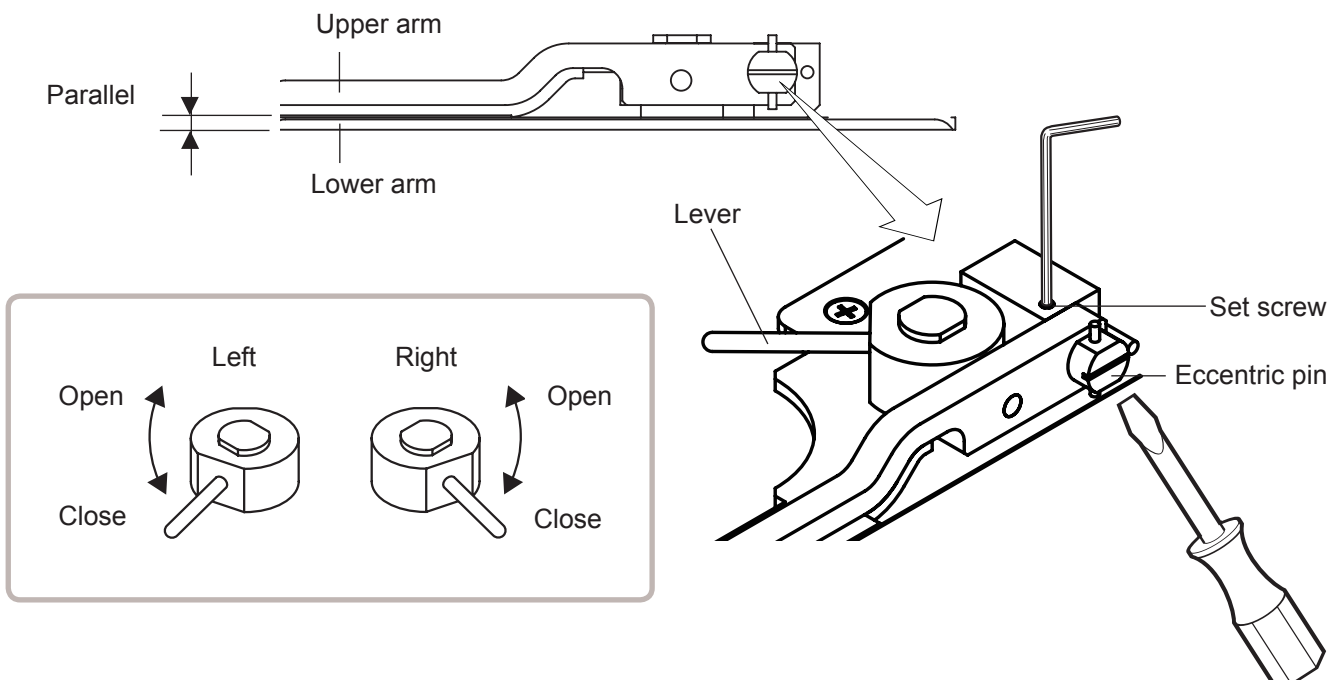
Adjust width of the upper arm to meet size of material and embroidery design.  
Width of the arm should have enough margins for embroidery area.  
Loosen both side knob nuts for adjustment of arm.  
Tighten all knob nuts after adjustment.



# ADJUSTMENT OF UPPER ARM

2-2

Please note that basically the upper arm and the lower arm should be parallel at locking position.  
In case the thickness of the material is uneven, use adjusting set screw and eccentric pin to change angle of the upper arm to give holding pressure evenly.



# INSTALLING THE FRAME

# 3-1

When you use side clamp frame, please make machine setting according to frame type selected.



## CAUTION: To avoid problems.

The machine and / or frame may be damaged if the incorrect frame settings are used.


1. Turn on the power switch.


Indicates the selected frame.



Selected frame



2. In case required  "Special frame" is already selected, press the **Next** and jump to operation no.4.

In case selected frame type is not "Special frame", press .



3. Select  "Special frame".



4. Press **Next**.

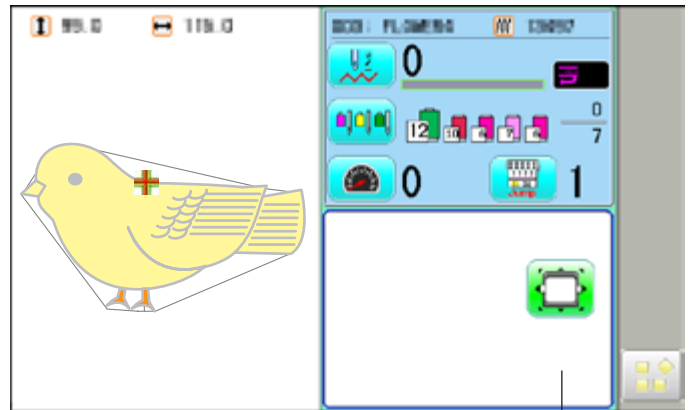


# INSTALLING THE FRAME


5. Press **OK** .

Indication of frame type disappears.  
It means that "Special frame" is selected.

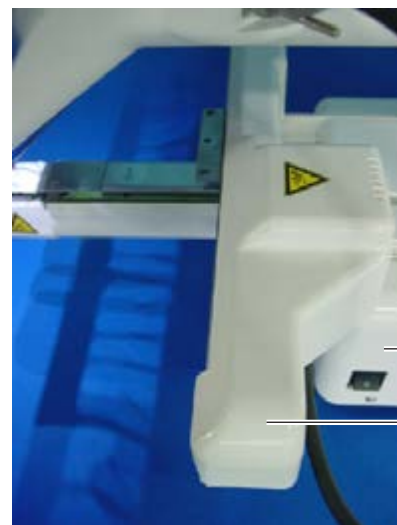
■ When you need to change from Special frame to other type of frame, please power machine off and start again.  
Without re-starting machine, machine will move incorrectly.



Frame indication disappears

6. Press  and move the carriage to the position

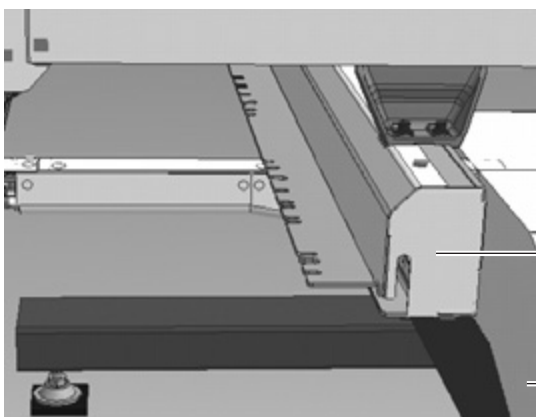
shown by press



HCH\*, HCS\*

Machine

Carriage



HCU\*

Carriage

Machine



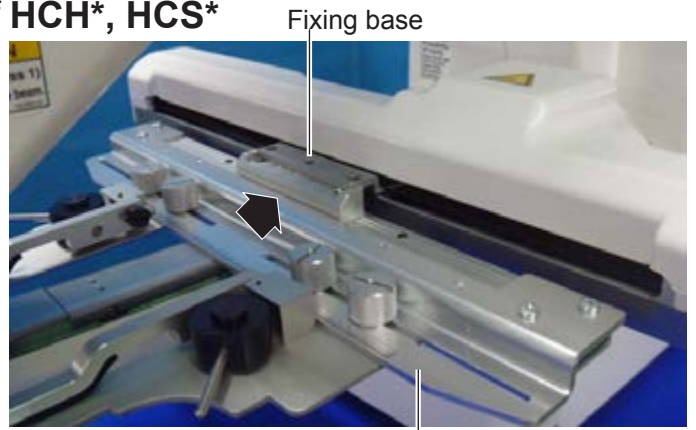
HCD\*

Carriage

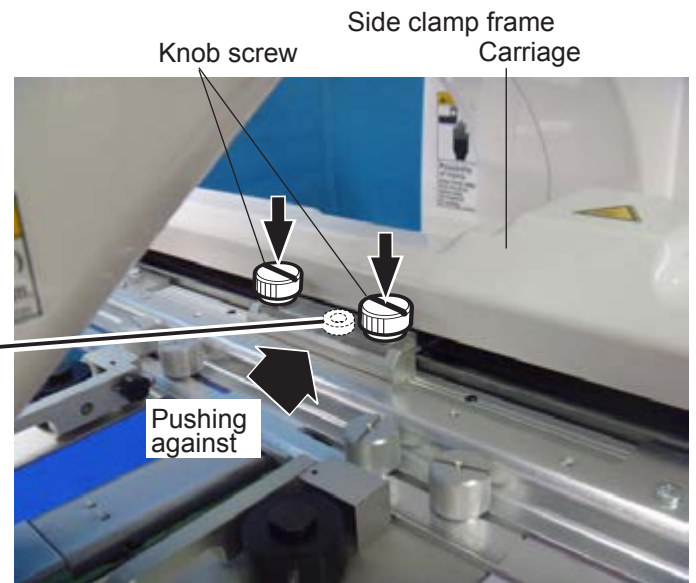
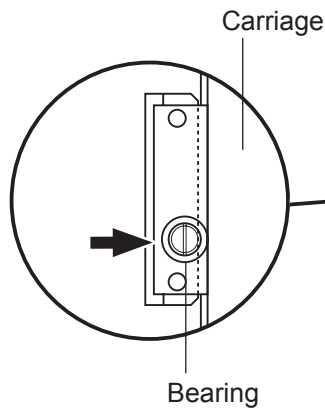
Machine

# INSTALLING THE FRAME

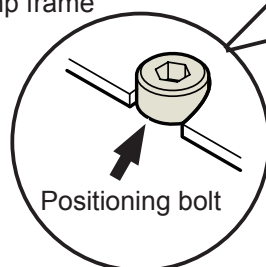
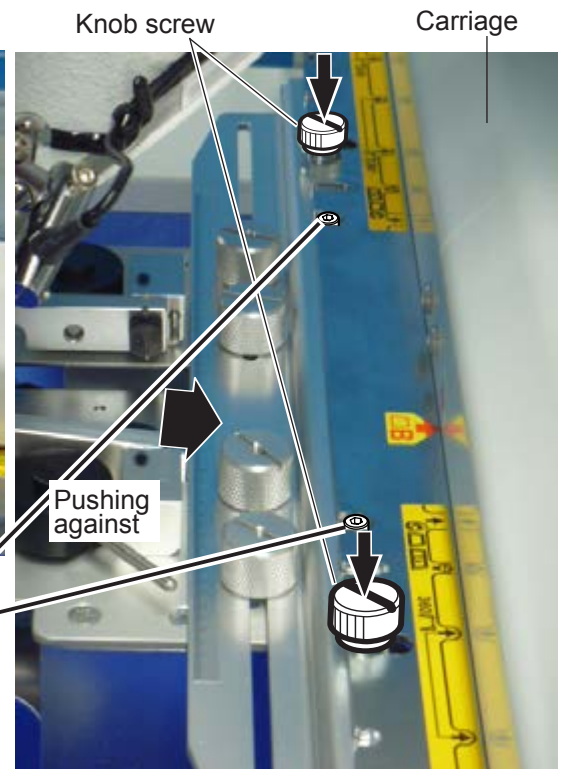
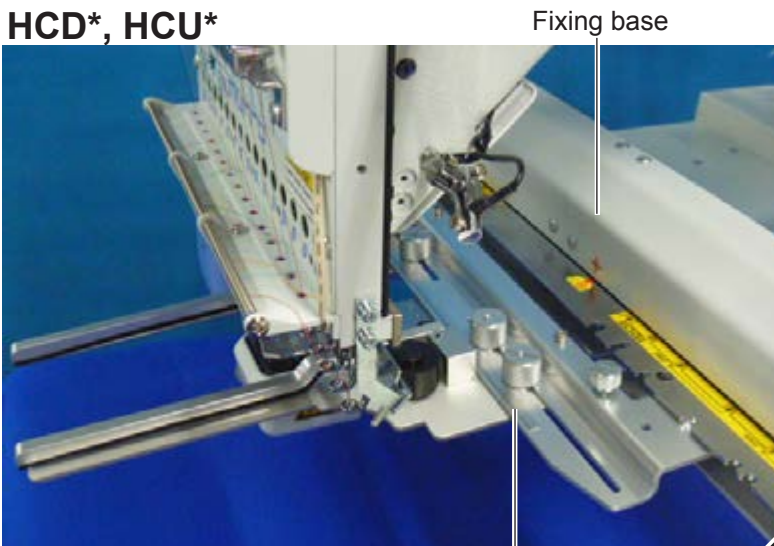
7. Insert shoe frame to below the fixing base of **HCH\***, **HCS\*** carriage by sliding on bed.



Fix knob screws as hitting the bearing against the carriage while pressing the side clamp frame to the carriage.

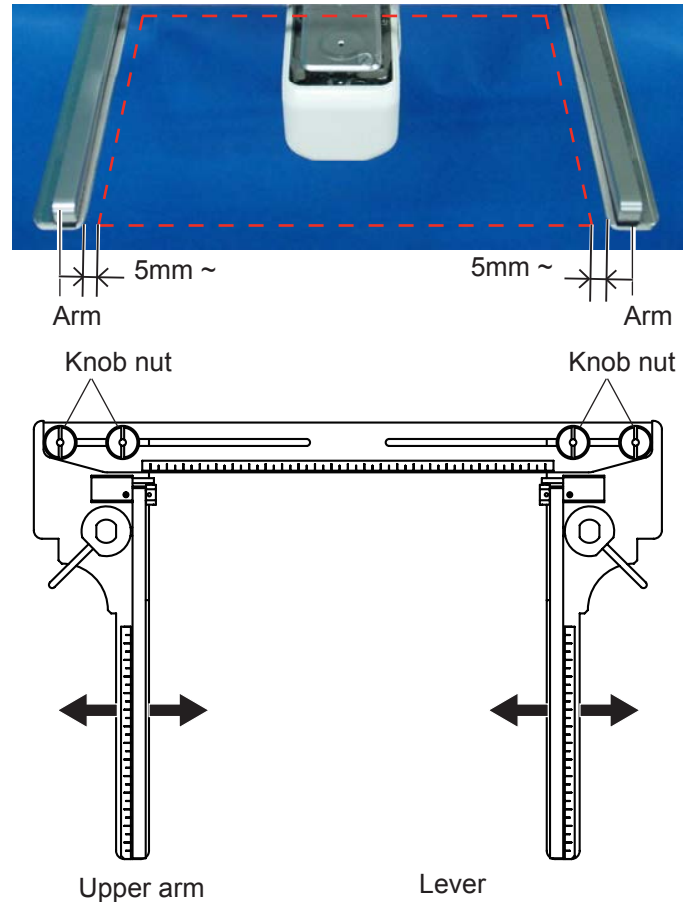


## HCD\*, HCU\*

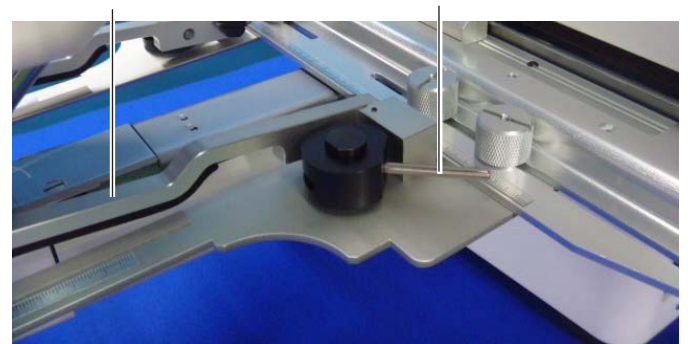
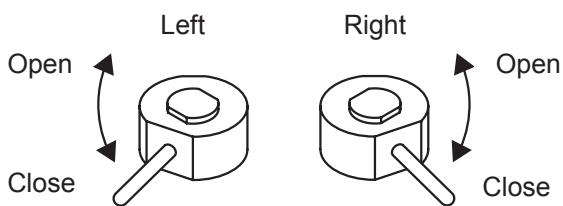


The following is an example for bag embroidery.

1. Adjust width of the arm to meet size of material and embroidery design.  
Width of the arm should have enough margins for embroidery area.  
Loosen both side knob nuts for adjustment of arm.  
Tighten all knob nuts after adjustment.



2. Turn right and left lever to open the upper arm.



3. Take off all removable parts like insole to reduce weight of the bag.  
Open all side zippers to keep the material flexible.

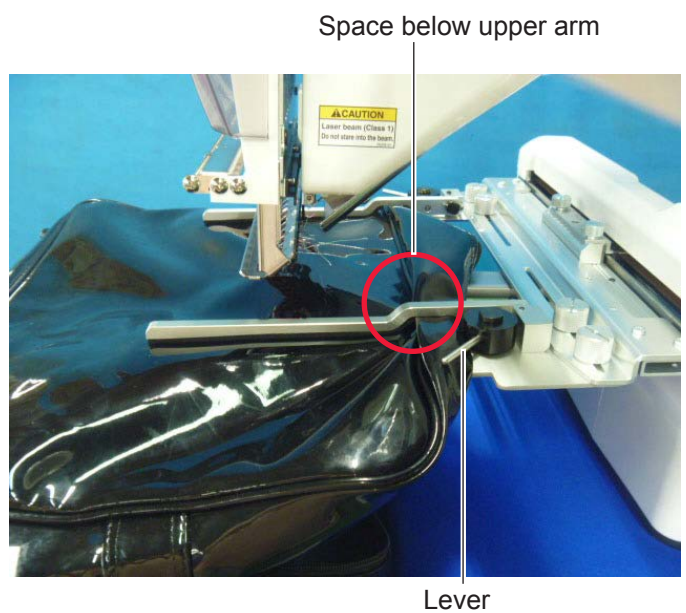


4. Turn right and left lever, then the bag will be locked.  
Please make sure that the material inside of embroidery area is set flat.

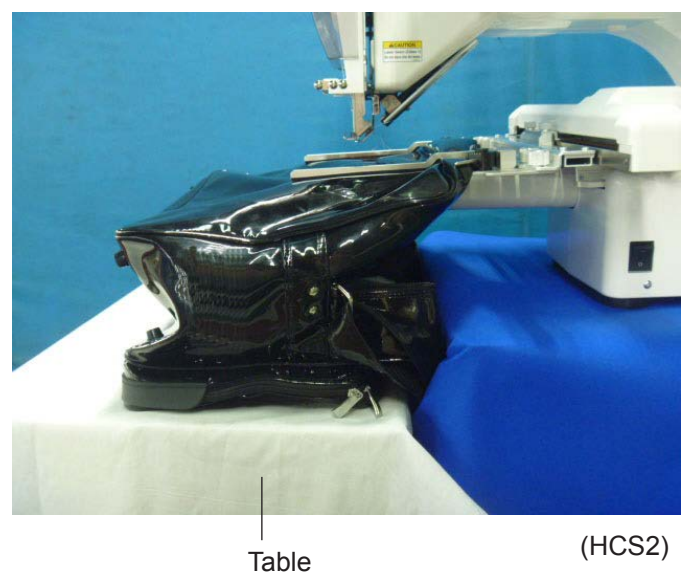
■ Please also check that no hard material like metal hook is located in the embroidery area.



Edge of bag should be set in the space below upper arm.

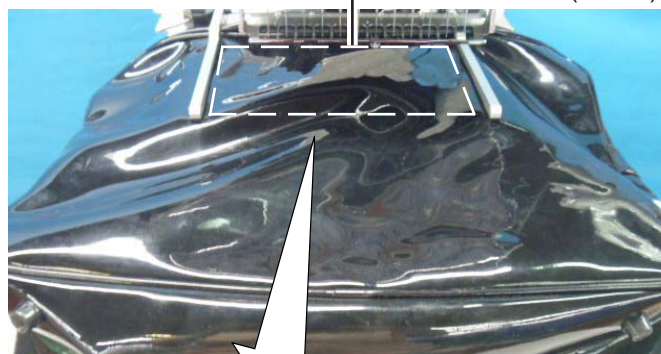


If the bag is too heavy, use support table to prevent the arm from slanting down.







Embroidery area (HCS2)




1. Press  and move the frame to the original point with the .

2. Press .

Press , and the embroidering frame moves for the design trace. You can confirm outline trace and the position of the design.

Press , and trace is stopped.

Go on to step 4 if you want to start embroidering without tracing.

3. Press  after the trace is completed.

The embroidering frame has moved to the first stitch point of the pattern.

4. Press .

The embroidery will start.

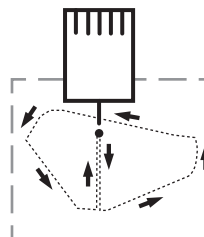
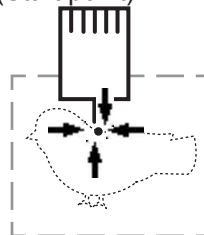
Hand support is also helpful when the arm is slanted down due to weight of the bag.



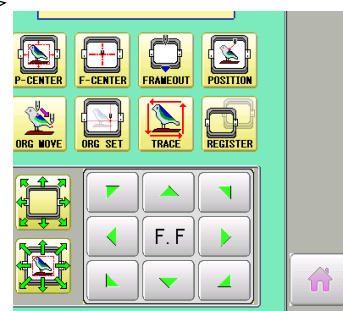
5. After embroidering your design is complete, show ">>End" and the machine will stop.

The embroidery frame returns to the original point automatically if the "Auto origin" function has been activated.

■ : Original point (Start point)



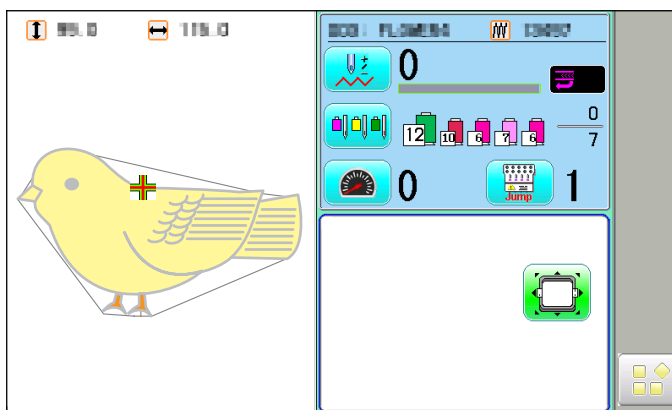
You can confirm the outline and position of design.



Backward only when pressing Forward only when pressing

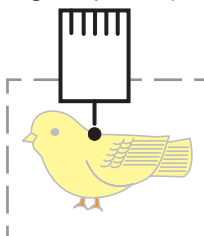


Pause button



>>End

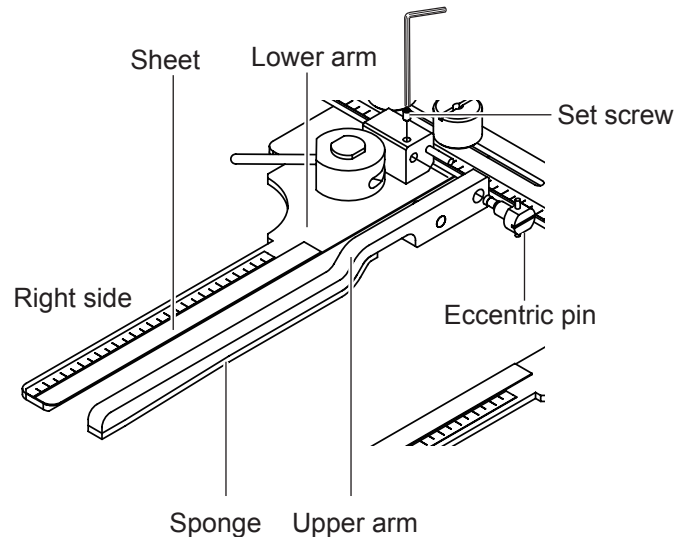
■ : Original point (Start point)



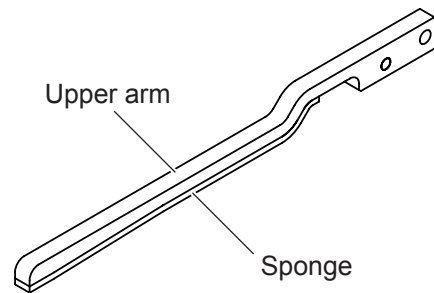
## ● EXCHANGE SPONGE AND SHEET

Sponge and sheet are located under the upper arm and on the lower arm to hold fabric firmly. When sponge or sheet are worn or damaged, please exchange sponge or sheet.

1. Remove the set screw and disassemble the eccentric pin.
2. Remove the upper arm.
3. Remove the sponge or sheet from the upper arm or the lower arm.

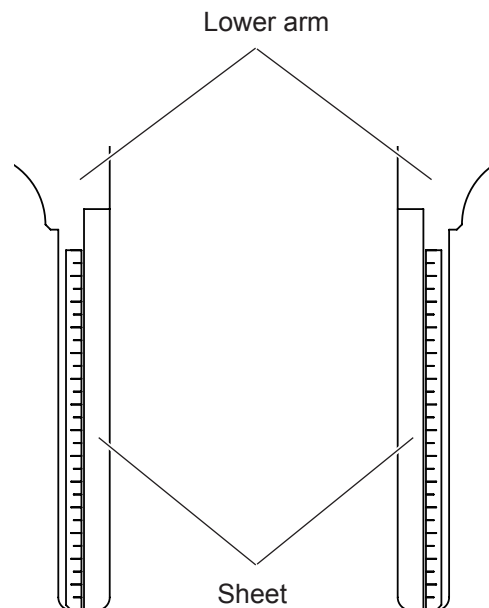


4. Attach the sponge to fit with the edge of the upper arm as shown.



5. Attach the sheet to fit with the edges of the lower arm as shown.

Cut to fit around the corner.

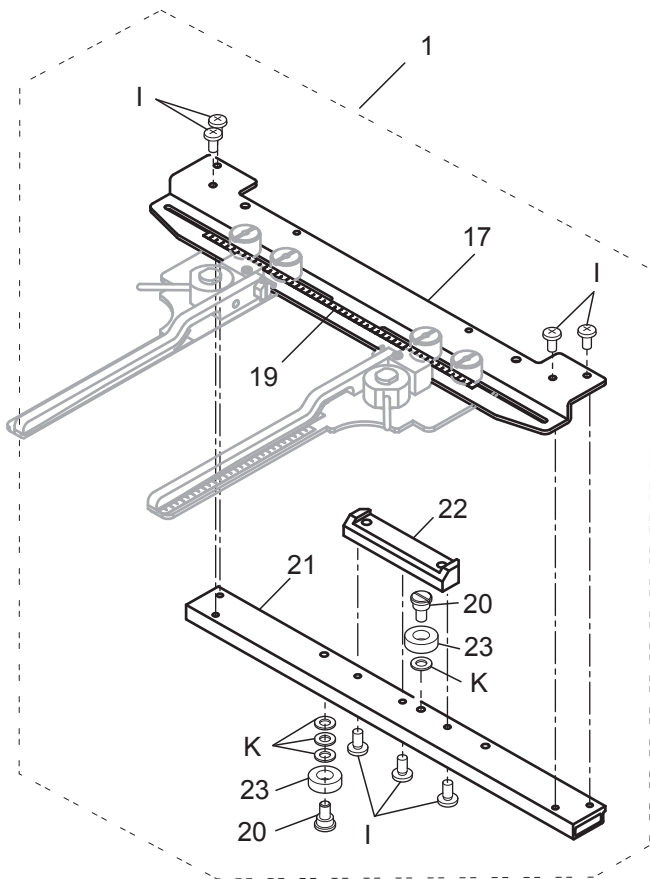


4. In the reverse order of disassembling, fix the upper frame by screw.

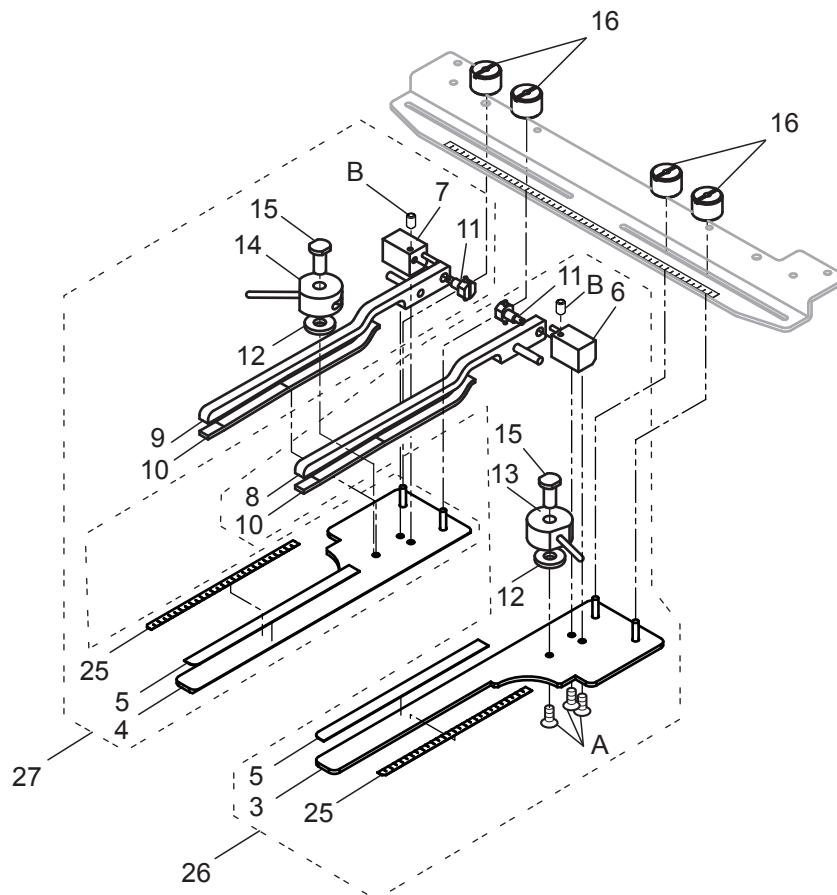
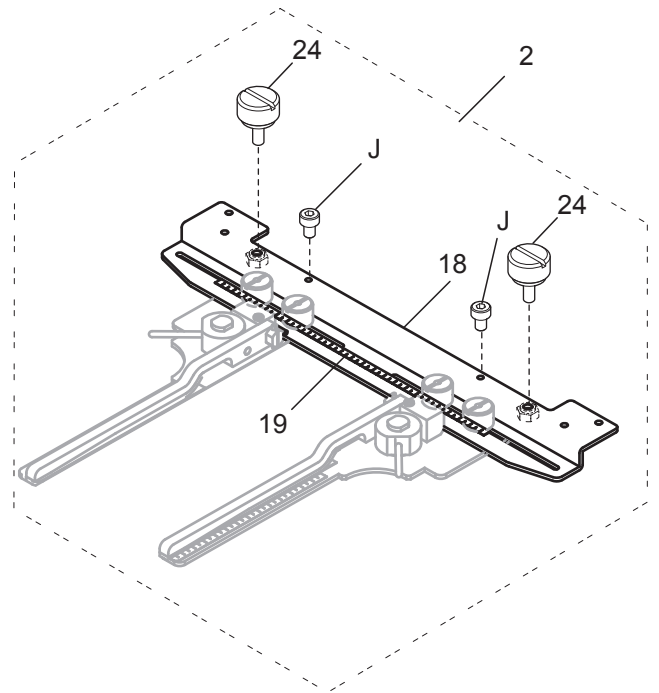
After fix the upper frame, adjust the upper frame in accordance with "ADJUSTMENT OF UPPER ARM 2-2".



## HCH\*, HCS\*



## HCD\*, HCU\*



# SIDE CLAMP FRAME サイドクランプ枠

7-2

指図	部品番号	部品名	FCS725 備考
Ass'y	El't Parts No.	Parts Names	Note
	1 FRA21G00	Side clamp frame ass'y (for HCH*, HCS*)	サイドクランプ枠組(HCH*, HCS*用)
	2 FRA21G10	Side clamp frame ass'y (for HCD*, HCU*)	サイドクランプ組(HCD*, HCU*用)
	3 FRA21I00	Lower arm long ass'y (right)	下アームロング(R)組
	4 FRA21I10	Lower arm long ass'y (left)	下アームロング(L)組
	5 FRA21I91	Sheet long	滑り止めシートロング
	6 FRA21F40	Fulcrum block ass'y (right)	支点ブロック(R)組
	7 FRA21F50	Fulcrum block ass'y (left)	支点ブロック(L)組
	8 FRA21I20	Upper arm long ass'y (right)	上アームロング(R)組
	9 FRA21I30	Upper arm long ass'y (left)	上アームロング(L)組
	10 FRA21I81	Sponge long	滑り止めスポンジロング
	11 FRA21F60	Eccentric pin ass'y	偏心ピン組
	12 MPZ04730	Washer	金属ワッシャ
	13 FRA21F20	Cam ass'y (right)	溝カム(R)組
	14 FRA21F30	Cam ass'y (left)	溝カム(L)組
	15 FRA21340	Shaft	シャフト
	16 FRA21I02	Knob nut	ノブナット
	17 FRA21I52	Connecting plate	靴枠連結板
	18 FRA21B51	Connecting plate ass'y	靴枠連結板組
	19 FRA21200	Scale sticker A (250mm)	メモリテープA
	20 HCB40041	Screw	ベアリング止めネジ
	21 HCB40121	Arm	連結アーム
	22 HCB40132	Bracket	取付け板
	23 MPB00250	Bearing (L1680ZZ)	ミニチュアベアリング
	24 HCD37092	Knob screw	ノブネジA
	25 FRA21210	Scale sticker B (140mm)	メモリシールB
	26 FRA21H00	SC frame clamp ass'y (right)	SC枠クランプ枠(R)組
	27 FRA21H10	SC frame clamp ass'y (left)	SC枠クランプ枠(L)組
	A SGAK04010	Flat head screw (phillips, M4x10)	十字穴付き皿小ねじ (M4×10)
	B SSAA03005	Hex socket screw (M3x5)	六角穴付き止めねじ (M3×5)
	I SBBK04008	Bind head screw (phillips, M4x8)	十穴付きバインド小ねじ (M4×8)
	J SCAD04006	Hex socket head cap screw (M4x6)	六角穴付きボルト (M4×6)
	K WPAD05000	Plain washer (M5)	平座金 (M5)

# HCH\*, HCS\*, HCD\*, HCU\*

## Square Clamp Frame

# INSTRUCTION MANUAL

Program Ver. \*1.60 ~

HappyJapan Inc.

FCU701-4

## IMPORTANT SAFETY INSTRUCTIONS

0



- Use this Manual together with Instruction Manual of embroidery machine for mounting this appliance and for operating.
- Use this appliance only for its intended use as described in this manual. Use only attachments recommended by the manufacturer as contained in this manual.
- Keep fingers away from all moving parts. Special care is required around the sewing machine needle.
- Do not pull or push fabric while stitching. It causes damage.
- Do not modify this appliance.

**SAVE THESE INSTRUCTIONS**

BASIC INFORMATION OF SQUARE CLAMP FRAME.....	1-1
ACCESSORIES.....	1-2
EMBROIDERY AREA.....	2-1
BACKING MATERIALS .....	2-2
ADJUSTMENT OF ARM.....	2-3
INSTALLING THE FRAME .....	3-1
W-clip.....	3-4
STARTING TO EMBROIDER .....	4-1
ETC.	
EXCHANGE SPONGE AND SHEET.....	5-1
PARTS LIST .....	6-1

# BASIC INFORMATION OF SQUARE CLAMP FRAME

1-1

The types of square clamp frame are described below.  
Use correct type of square clamp frame for your embroidery machine.

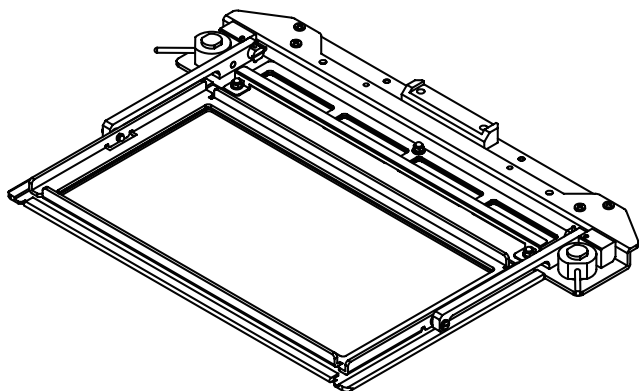


**CAUTION: To avoid problems.**

To use square clamp frame, select "Border/Clamp frame" from frame selection menu.

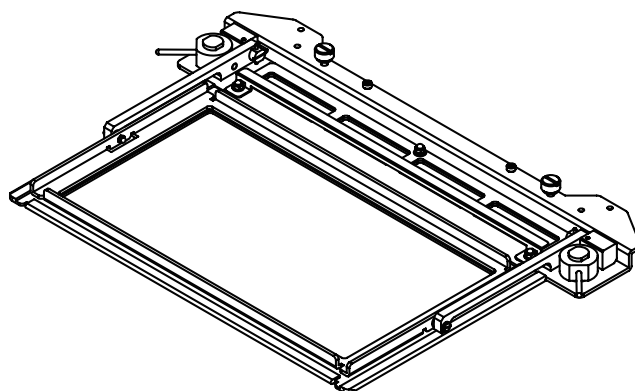
FRA22A2

Square clamp frame (L) ass'y (for HCH\*, HCS\*)



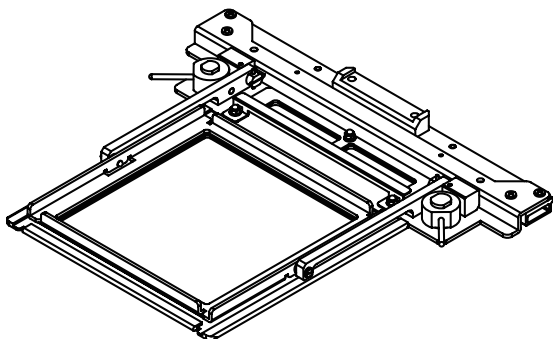
FRA22A3

Square clamp frame (L) ass'y (for HCD\*, HCU\*)



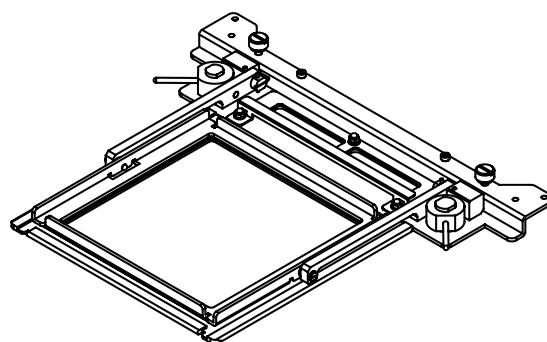
FRA22A0

Square clamp frame (S) ass'y (for HCH\*, HCS\*)



FRA22A1

Square clamp frame (S) ass'y (for HCD\*, HCU\*)



# ACCESSORIES

1-2

FRA48140 W-clip (M) (L:3 pcs, S:2 pcs)

MPZ05110 W-clip (S) (L:3 pcs, S:2 pcs)  
(packed with frame)



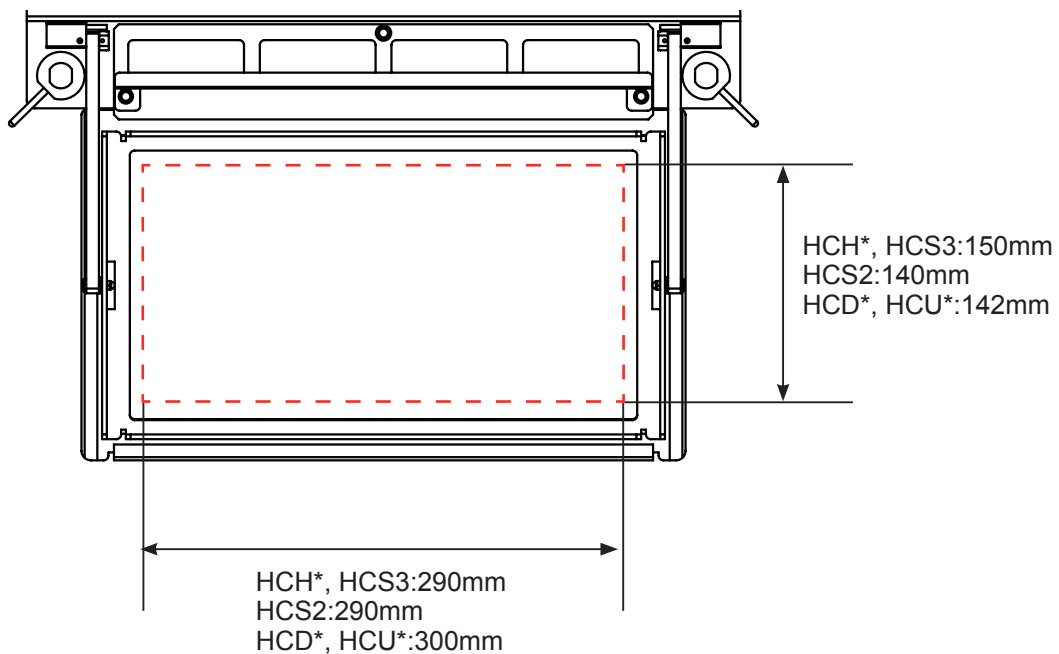
FRA22130 Sponge (L:6 pcs, S:4 pcs)

FRA22140 Sheet (L:6 pcs, S:4 pcs)  
(packed with frame)

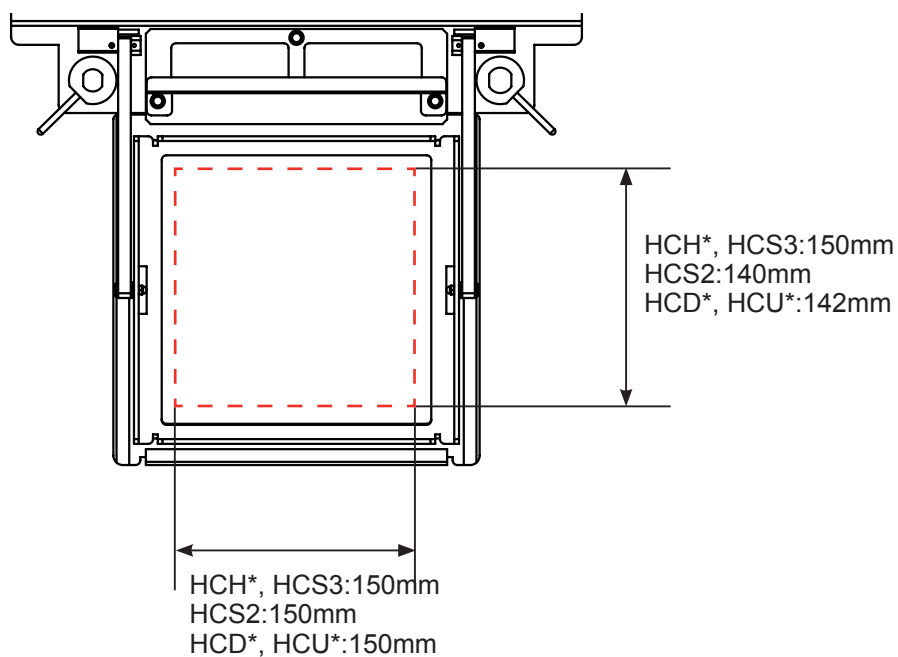




## Square clamp frame (L)



## Square clamp frame (S)



## Backing

Generally, Backing is used for hooped embroidery fabric. Knit fabrics particularly require the use of embroidery backings.

Embroidery backings will allow the hoop to move the fabric more accurately, creating a more beautiful embroidery.

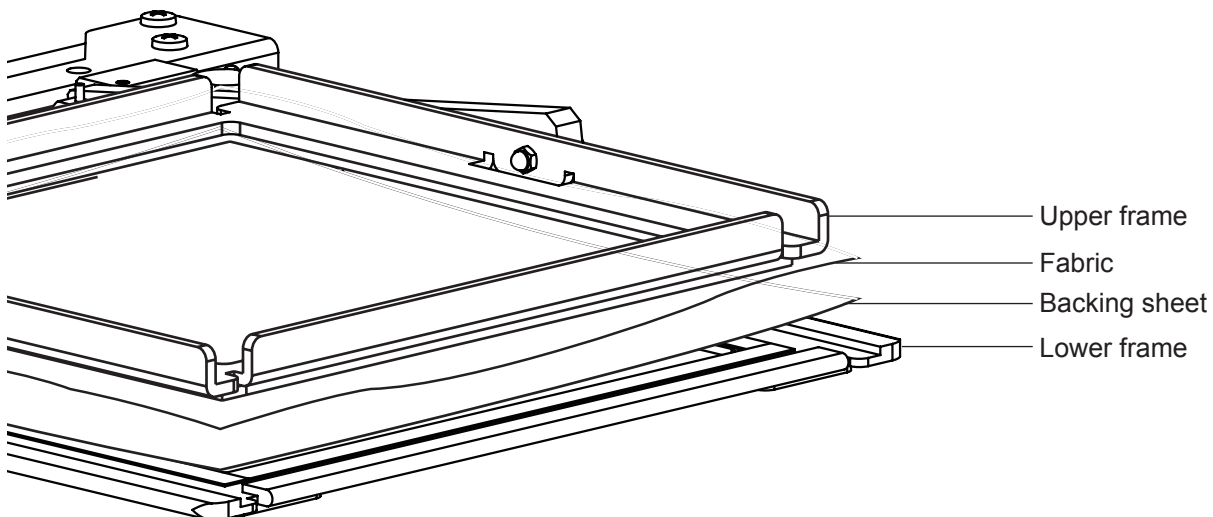
## Select backing type

Choose the thickness and number of sheets by the type of material and embroidery condition. Generally, you should consider the following items.

- Embroidery stitch quality
- Contraction or compression of fabric caused by sewing, etc.
- Stiffness of fabric

■ In case, if you sew lace and leather, you may not need backing sheet.

## Example of using a backing

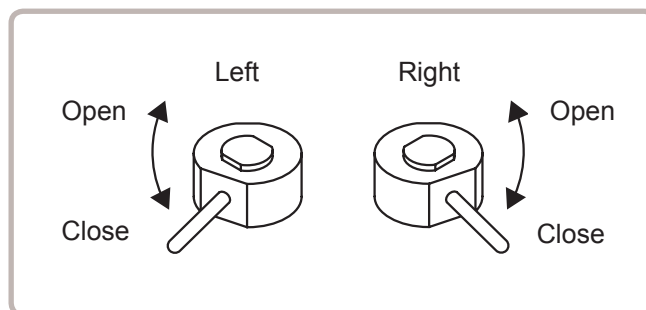
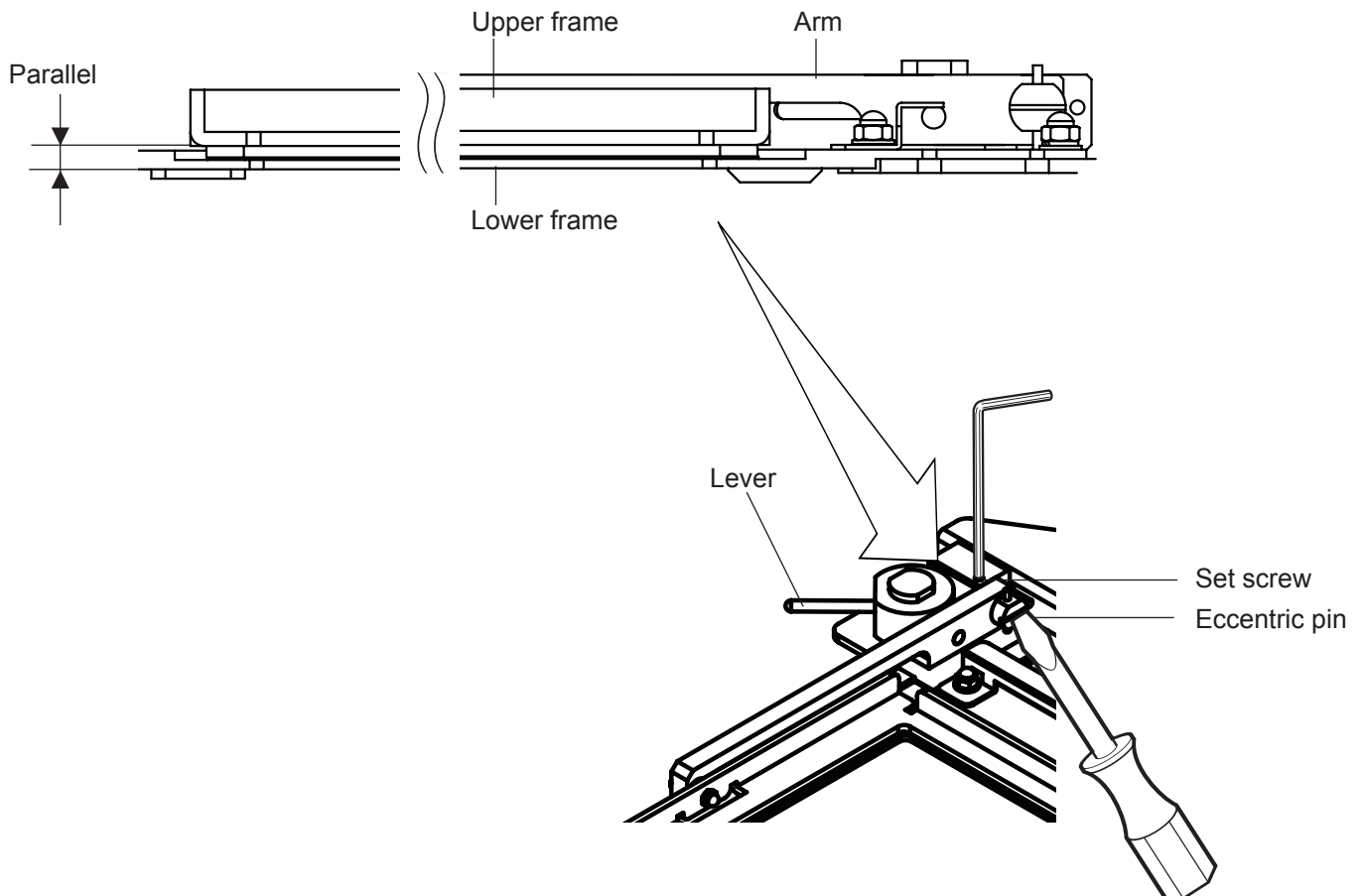


# ADJUSTMENT OF ARM

2-3

Please note that basically the upper frame and the lower frame should be parallel at locking position.

In case the thickness of the material is uneven, use adjusting set screw and eccentric pin to change angle of the arm to give holding pressure evenly.





**CAUTION: To avoid problems.**

The machine and / or frame may be damaged if the incorrect frame settings are used.


1. Turn on the power switch.


Indicates the selected frame.



Selected frame



2. In case required  "Border/Clamp frame" is already selected, press the **Next** and jump to operation no.4.

In case selected frame type is not "Border/Clamp frame", press .

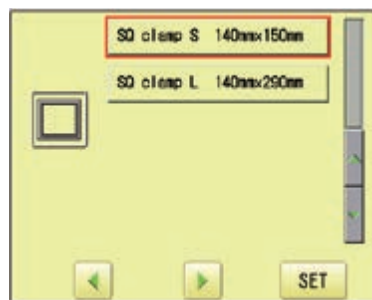


3. Select  "Border/Clamp frame".

**HCH\*, HCS3**



**HCS2**



**HCD\*, HCU\***



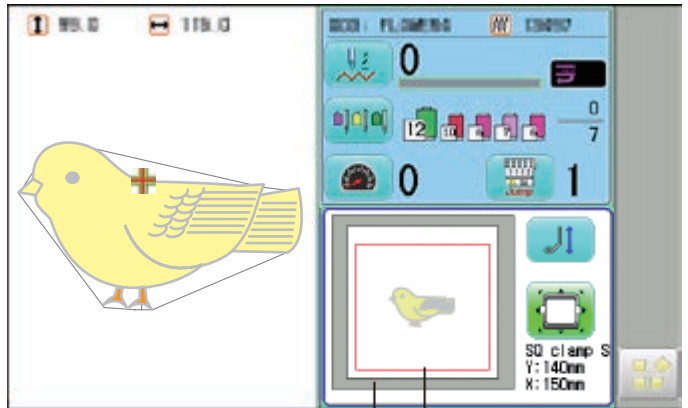
4. Select desired type of frame and Press **Next**.



# INSTALLING THE FRAME

5. Press **OK**.

It means that "Clamp frame" is selected.



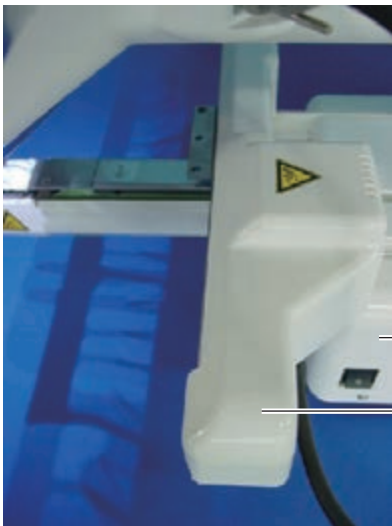
**HCS2**

Embroidery area  
Square clamp frame (S)

**HCD\*, HCU\***

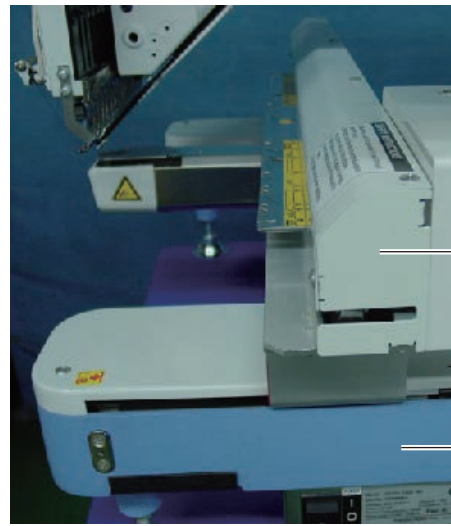


**HCH\***



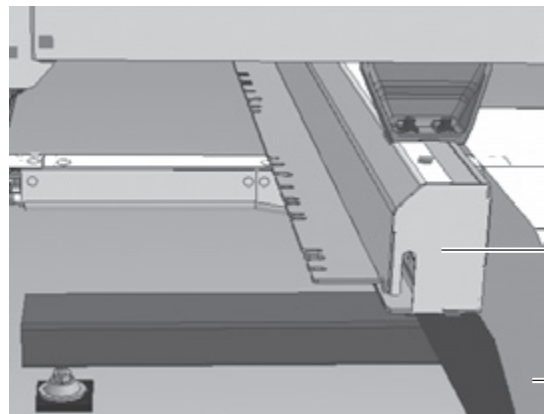
**HCH\*, HCS\***

Machine  
Carriage



**HCD\***

Carriage  
Machine



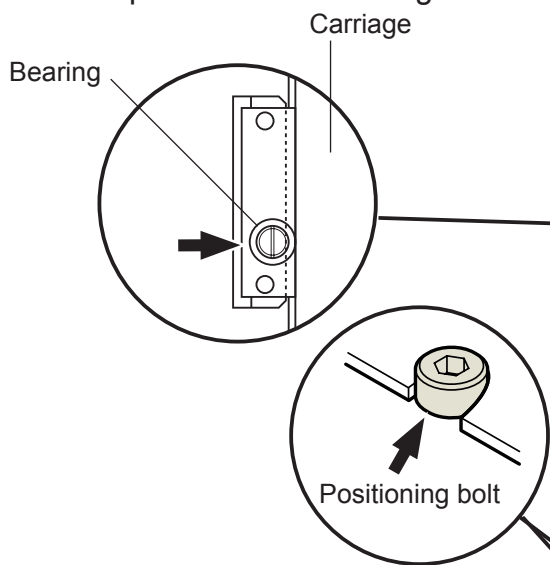
**HCU\***

Carriage  
Machine

# INSTALLING THE FRAME

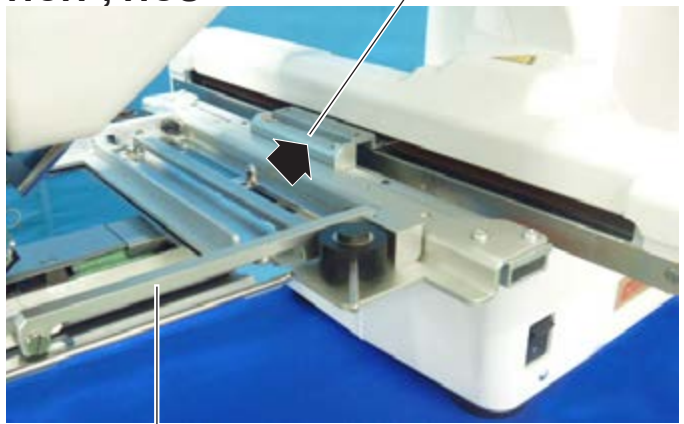
7. Insert square clamp frame to below the fixing base of carriage by sliding on bed.

Fix knob screws as hitting the bearing against the carriage while pressing the square clamp frame to the carriage.

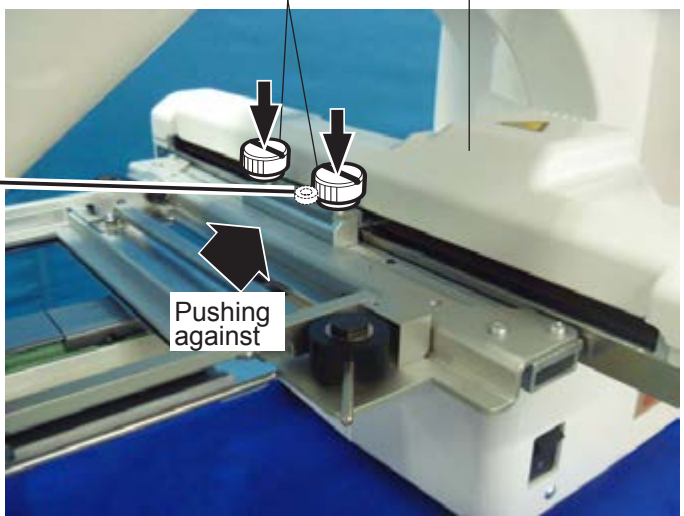


HCH\*, HCS\*

Fixing base



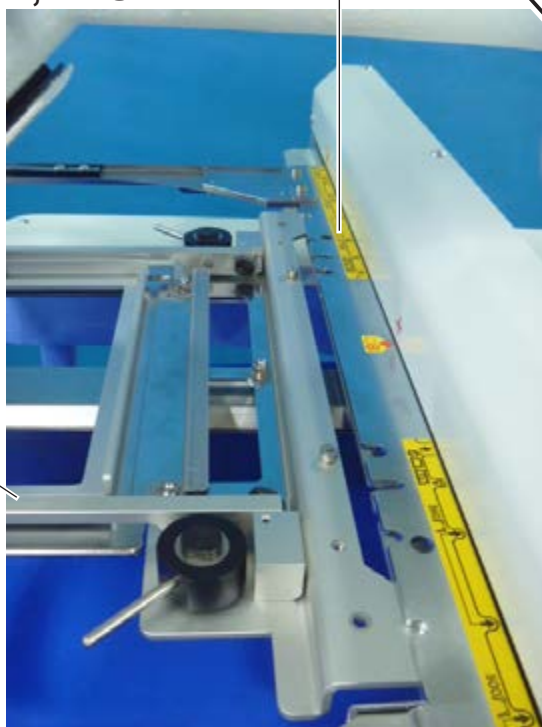
Square clamp frame (S)  
Knob screw Carriage



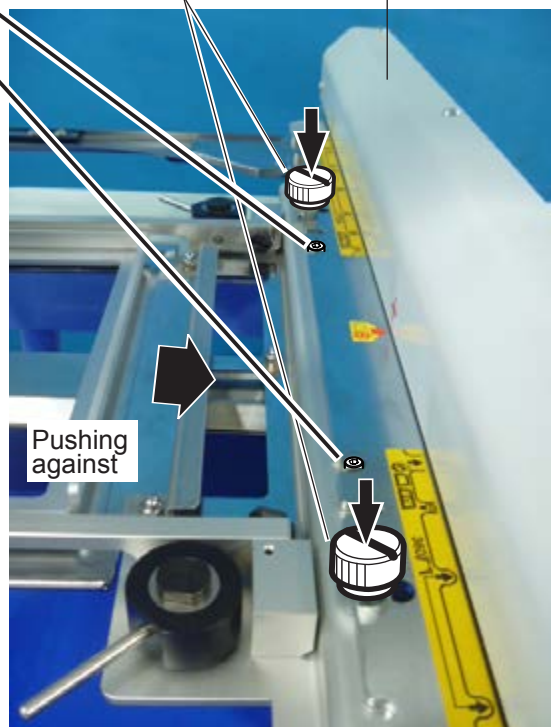
HCD\*, HCU\*

Fixing base

Square clamp frame (S)

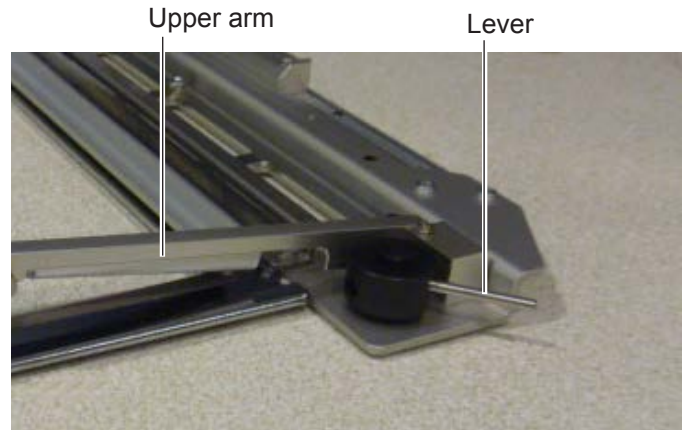
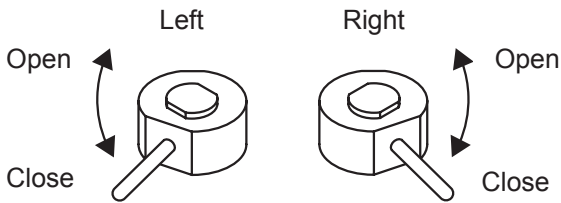


Knob screw Carriage



The following is an example to make embroidery on the felt cloth.

1. Turn right and left lever to open the upper arm.

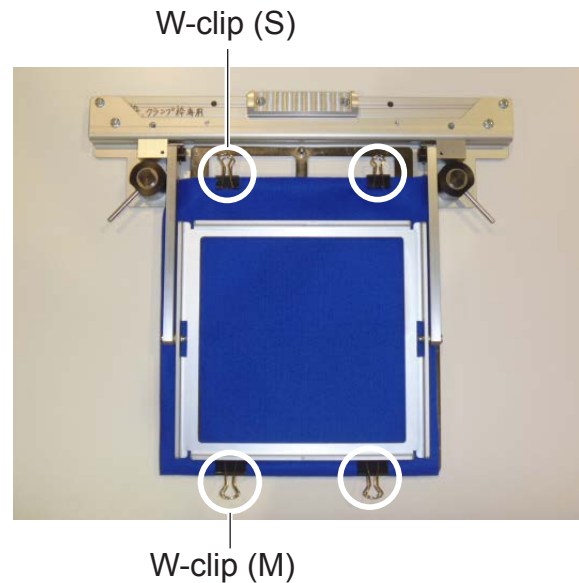
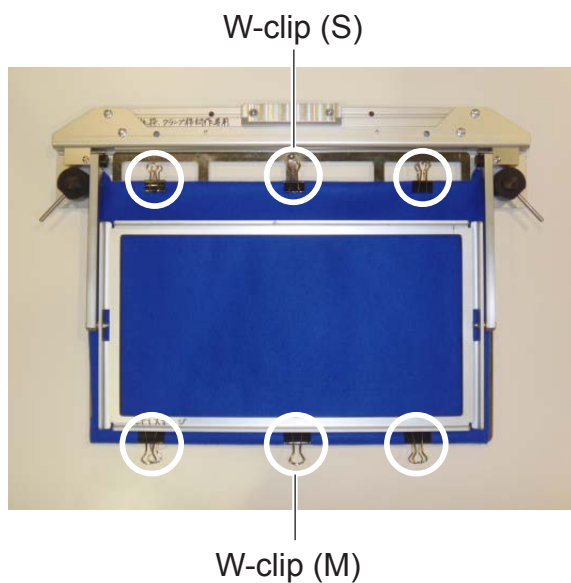


2. Turn right and left lever, then the felt cloth will be locked.  
Please make sure that the material inside of embroidery area is set flat.




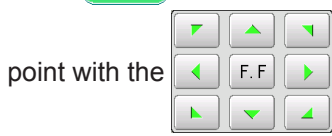
## W-clip

W-clip is used when you make embroidery on stretch fabric or thin fabric. Especially large design or many filling stitches is required, fabric may shrink.








1. Press  and move the frame to the original



2. Press .

Press , and the embroidering frame moves for the design trace.  
You can confirm outline trace and the position of the design.  
Press , and trace is stopped.

Go on to step 4 if you want to start embroidering without tracing.

3. Press  after the trace is completed.

The embroidering frame has moved to the first stitch point of the pattern.

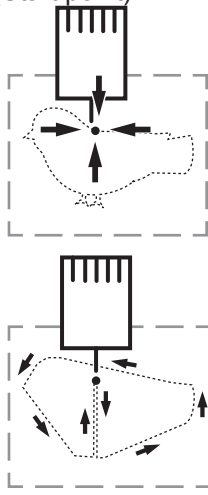
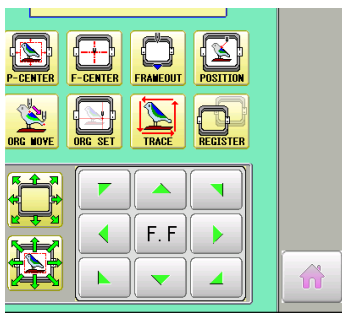
4. Press .

The embroidery will start.

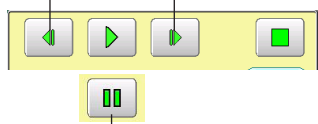
5. After embroidering your design is complete, show ">>End" and the machine will stop.

The embroidery frame returns to the original point automatically if the "Auto origin" function has been activated.

● : Original point (Start point)

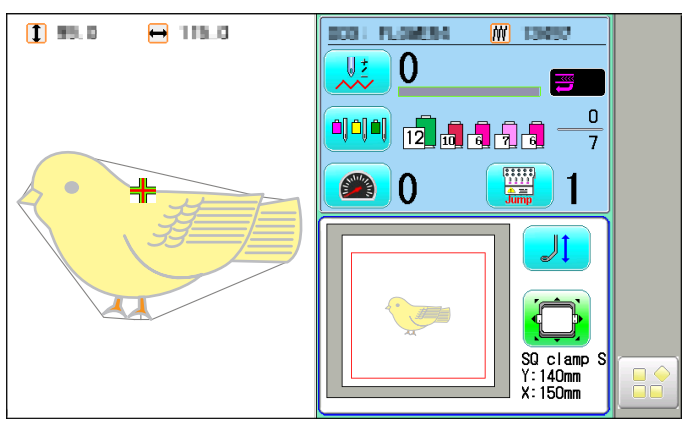



Backward only when pressing Forward only when pressing



Pause button

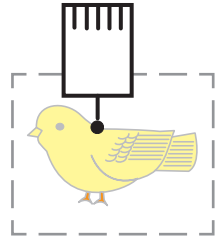
You can confirm the outline and position of design.



(HCH)

>>End

● : Original point (Start point)





●EXCHANGE SPONGE AND SHEET

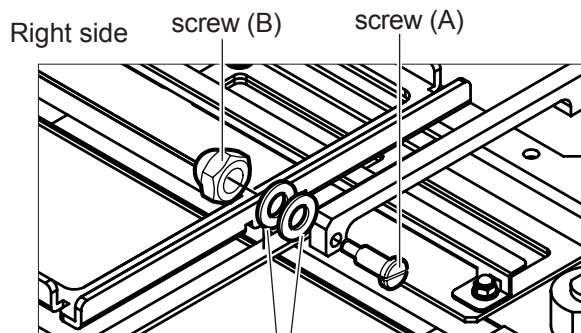
Sponge and sheet are located under the upper frame and on the lower frame to hold fabric firmly.

When sponge or sheet are worn or damaged, please exchange sponge or sheet.

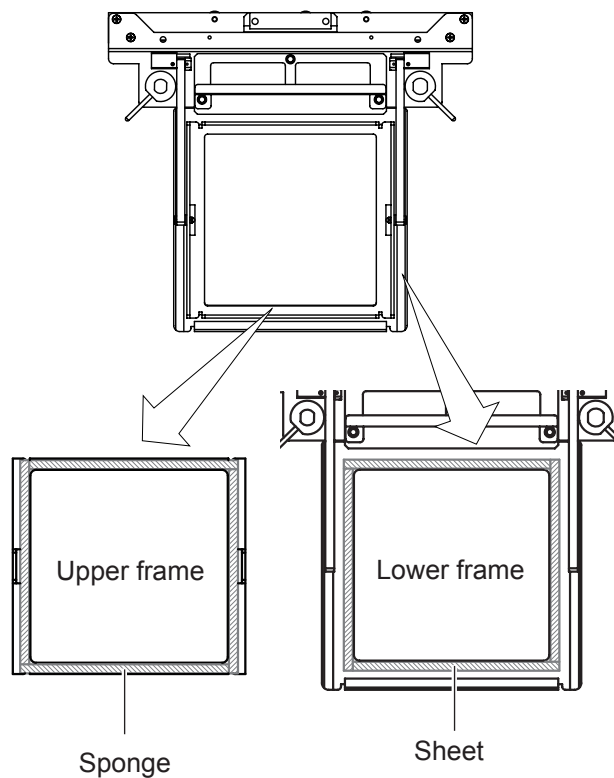
Please cut sponge or sheet to required length and attach to the under upper frame or on the lower frame.

The following is an example to use Square clamp frame (S).

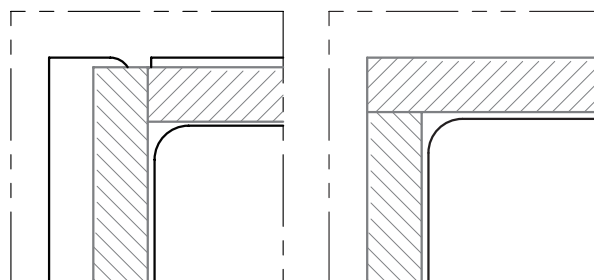
1. Remove the screw (A,B) at the right and left and disassemble the upper frame.



2. Remove the sponge or sheet from the upper frame or lower frame.



3. Attach the sponge or sheet to fit with the edges of the upper frame or lower frame.



4. In the reverse order of disassembling, fix the upper frame by screw.

Upper frame

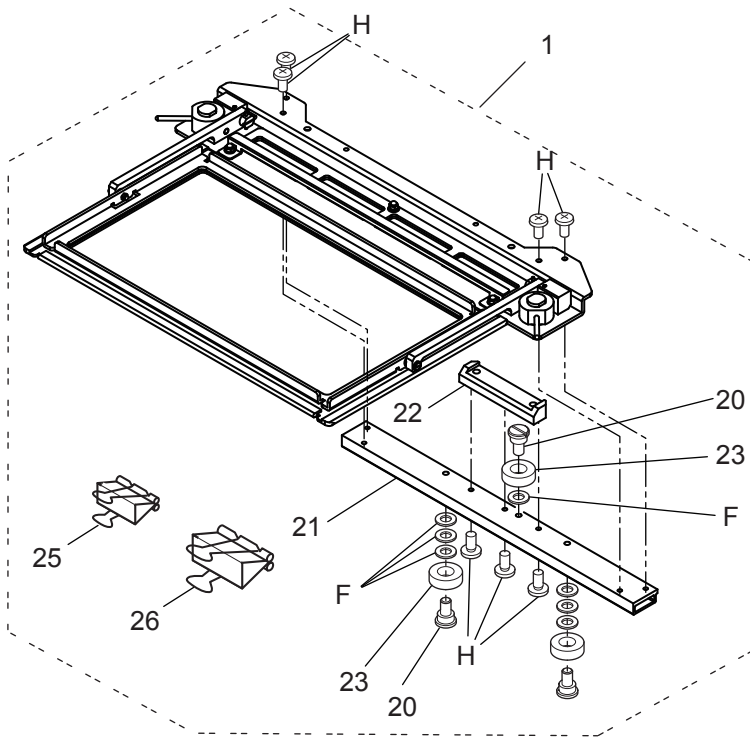
Lower frame

# SQUARE CLAMP FRAME (L)

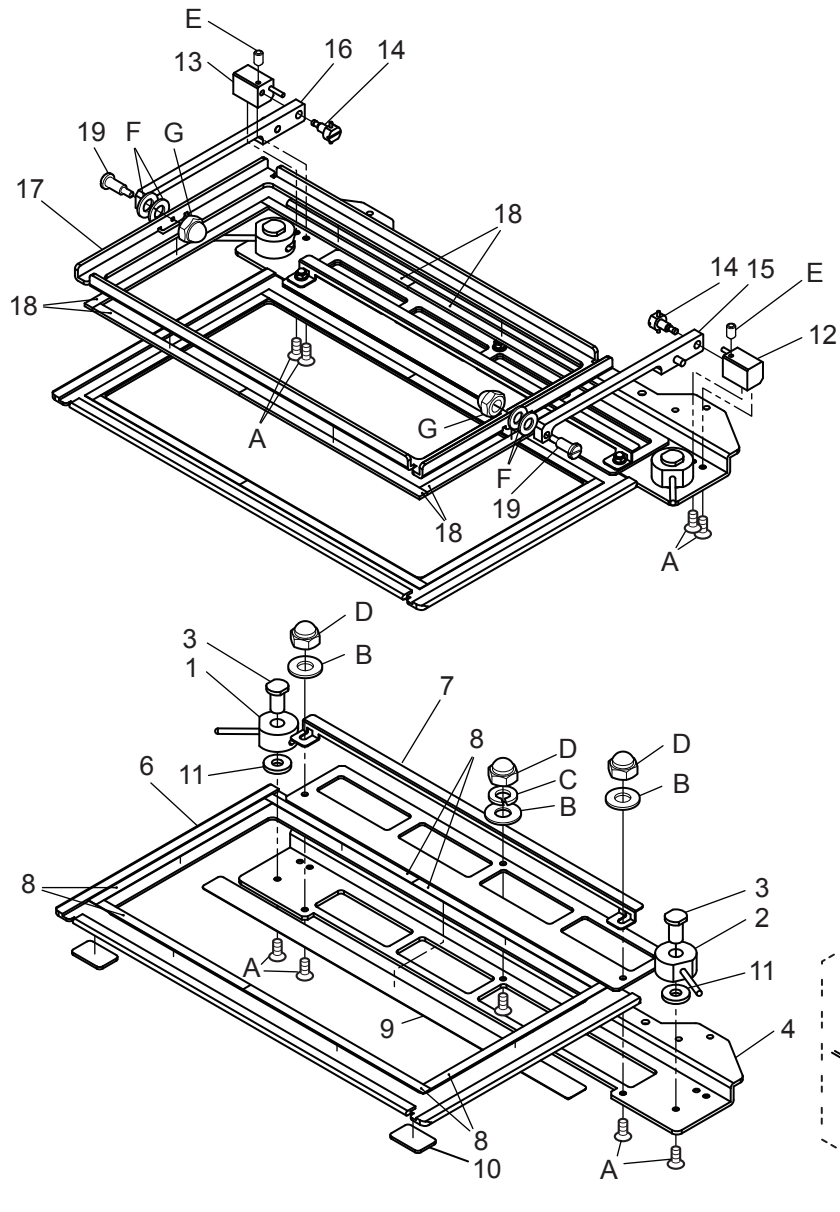
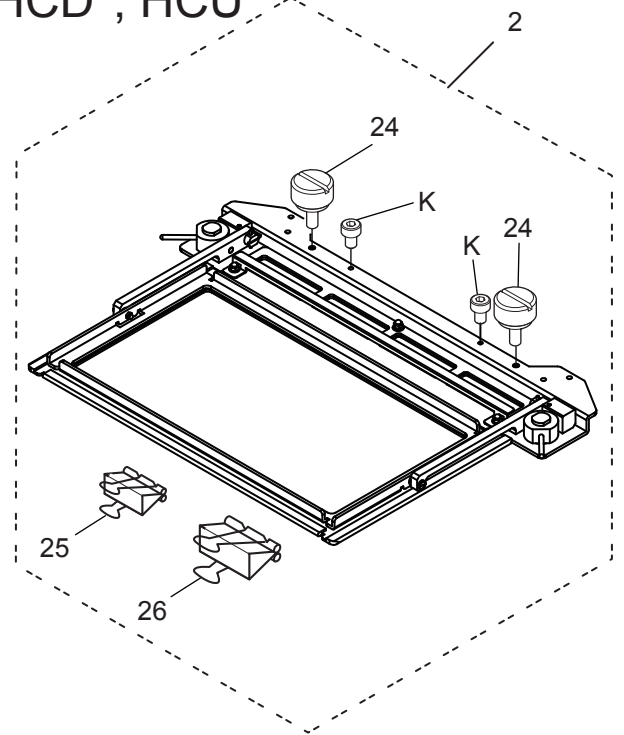
FCTC12

6-1

HCH\*, HCS\*



HCD\*, HCU\*



指図	部品番号	部品名	FCPA15	備考
Ass'y	El't	Parts No.	Parts Names	Note
	1	FRA21A00	Square clamp frame (L) ass'y (for HCH*, HCS*)	手動クランプ枠150300組(HCH*/HCS*) (L)
	1	FRA22A0	Square clamp frame (S) ass'y (for HCH*, HCS*)	手動クランプ枠□150組(HCH*/HCS*) (S)
	2	FRA21A10	Square clamp frame (L) ass'y (HCD*, HCU*)	手動クランプ枠150300組(HCD*, HCU*) (L)
	2	FRA22A1	Square clamp frame (S) ass'y (HCD*, HCU*)	手動クランプ枠□150組(HCD*, HCU*) (S)
	1	FRA21F20	Cam (right) ass'y	溝カム(R)組
	2	FRA21F30	Cam (left) ass'y	溝カム(L)組
	3	FRA21340	Shaft	シャフト
	4	FRA22060	Connecting bracket (150300)	連結ブラケット(150300) (L, HCH*, HCS*)
	4	FRA22000	Connecting bracket (□150)	連結ブラケット(□150) (S, HCH*, HCS*)
	5	FRA22B30	Connecting bracket (150300) ass'y	連結ブラケット(150300)組 (L, HCD*, HCU*)
	5	FRA22B20	Connecting bracket (□150) ass'y	連結ブラケット(□150)組 (S, HCD*, HCU*)
	6	FRA22100	Lower frame ass'y (150300)	下枠溶接組(150300) (L)
	6	FRA22030	Lower frame ass'y (□150)	下枠溶接組(□150) (S)
	7	FRA22120	Clip bracket (150300)	クリップブラケット(150300) (L)
	7	FRA22060	Clip bracket (□150)	クリップブラケット(□150) (S)
	8	FRA22140	Sheet	滑り止めシート
	9	FRA22160	Plate B	滑りプレートB (L)
	9	FRA22150	Plate A	滑りプレートA (S)
	10	FRA22170	Plate C	滑りプレートC
	11	MPZ04730	Washer	金属ワッシャ
	12	FRA21F40	Fulcrum block (right) ass'y	支点ブロック(R)組
	13	FRA21F50	Fulcrum block (left) ass'y	支点ブロック(L)組
	14	FRA21F60	Eccentric pin ass'y	偏心ピン組
	15	FRA22B00	Arm (right) ass'y	アーム(R)組
	16	FRA22B10	Arm (left) ass'y	アーム(L)組
	17	FRA22110	Upper frame (150300)	上枠(150300) (L)
	17	FRA22050	Upper frame (□150)	上枠(□150) (S)
	18	FRA22130	Sponge	滑り止めスポンジ
	19	MPZ05090	Support screw	支点用段付きねじ
	20	HCB40041	Screw	ベアリング止めねじ
	21	HCB40121	Arm	連結アーム
	22	HCB40132	Bracket	取付け板
	23	MPB00250	Bearing (L1680ZZ)	ミニチュアベアリング
	24	HCD37092	Knob screw	ノブネジA
	25	MPZ05110	W-clip (S)	ダブルクリップ(小)
	26	FRA48140	W-clip (M)	ダブルクリップ(中)
	A	SGAK04010	Flat head screw (phillips, M4x10)	十字穴付き皿小ねじ (M4×10)
	B	WPAD04000	Plain washer (M4)	平座金 (M4)
	C	WSAD04000	Spring lock washer (M4)	ばね座金 (M4)
	D	NDAD04000	Acorn nut (M4)	六角袋ナット (M4)
	E	SSAA03005	Hex socket screw (M3x5)	六角穴付き止めねじ (M3×5)
	F	WPAD05000	Plain washer (M5)	平座金 (M5)
	G	NDAD03000	Acorn nut (M3)	六角袋ナット (M3)
	H	SBAK04008	Bind head screw (phillips, M4x8)	十字穴付きバインド小ねじ (M4×8)
	I	SCAD04006	Hex socket head cap screw (M4x6)	六角穴付きボルト (M4×6)

# HCH\*,HCS\*, HCD\*,HCU\*

## One Touch Frame

# INSTRUCTION MANUAL

Program Ver. \*1.62 ~

HappyJapan Inc.

FOU701-3

## IMPORTANT SAFETY INSTRUCTIONS

0



### CAUTION

Make sure to observe the followings:

- Before installing this appliance and starting the operation, read and understand both One Touch Frame instruction manual(this book) and the instruction Manual of the embroidery machine to ensure safety.
- Do not use this appliance for any purpose other than those described in this manual. Use only the attachments the manufacturer recommends in this manual.
- While the machine is operating, keep an eye on the needles and keep fingers away from all the moving parts.
- Do not pull or push the frame while stitching. Otherwise, damage will be caused on the machine.
- Do not modify this appliance.

BASIC INFORMATION OF ONE TOUCH FRAME.....	1-1
BASIC INFORMATION OF ONE TOUCH FRAME BASE .....	2-1
EMBROIDERY AREA .....	3-1
HOW TO HOOP .....	4-1
INSTALLING THE FRAME .....	5-1
INSTALL THE FRAME BASE.....	5-1
SELECT A FRAME .....	5-3
ATTACHING THE FRAME .....	5-4
REMOVING THE FRAME .....	5-4
STARTING TO EMBROIDER.....	6-1
PARTS LIST .....	7-1

# BASIC INFORMATION OF ONE TOUCH FRAME 1-1

One touch frame has 3 variations as shown below:

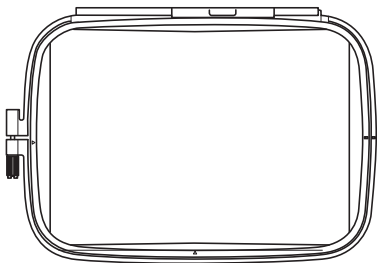


## NOTICE:

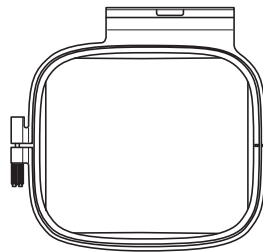
Before installing one touch frame, select "Tubular square frame" and the frame to be installed, then confirm that the embroidery pattern falls within the frame's embroidery area.

When changing type of one touch frame, the frame size on the machine must be changed together. Otherwise, the frame could hit the bed when moving and could fall apart.

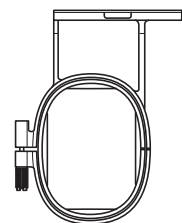
FRA-23A2-0  
One touch frame (16X22)



FRA-23A3-0  
One touch frame (13X15)



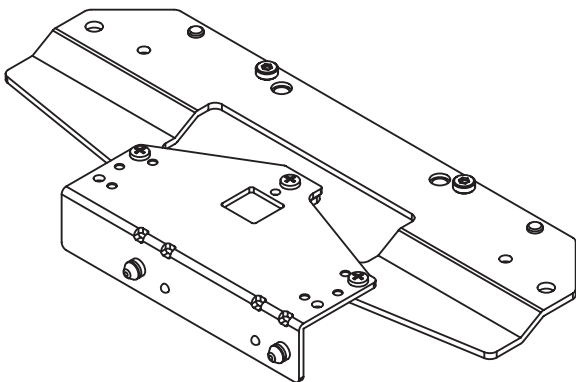
FRA-23A4-0  
One touch frame (9X6)



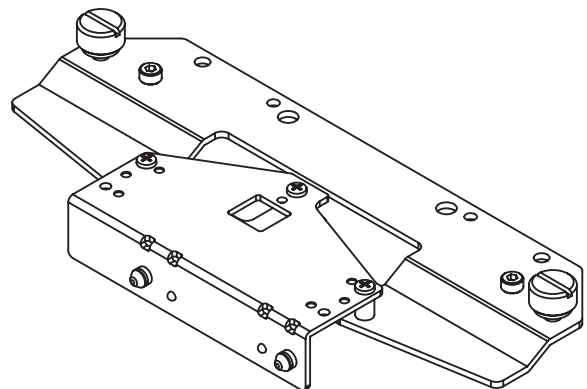
# BASIC INFORMATION OF ONE TOUCH FRAME BASE 2-1

When using one touch frame, install the frame base to embroidery machine.  
The types of frame base are described below;

FRA-23A0-0  
One touch frame base for HCH\*, HCS\*



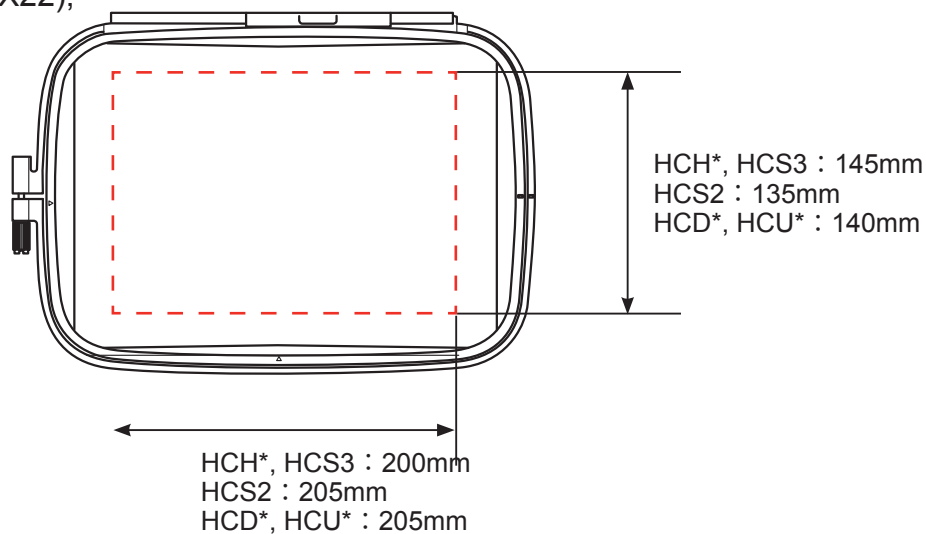
FRA-23A1-0  
One touch frame base for HCD\*, HCU\*



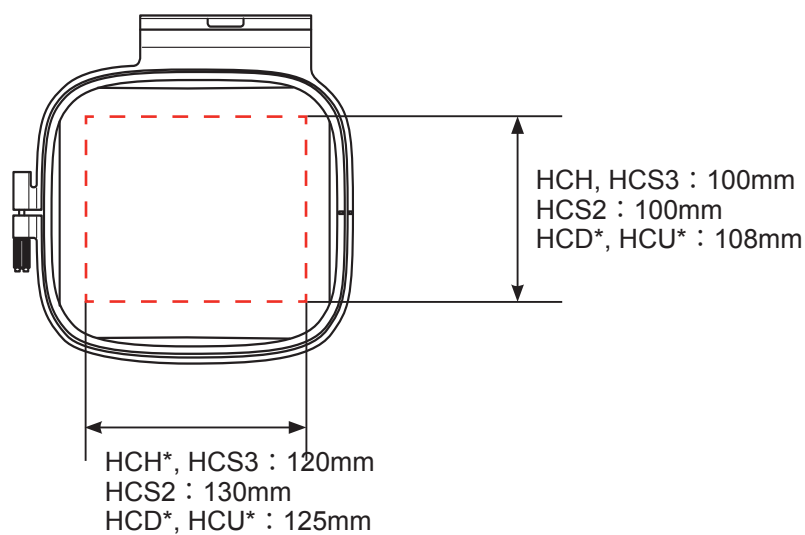
## NOTICE:

Use appropriate frame base for your embroidery machine.

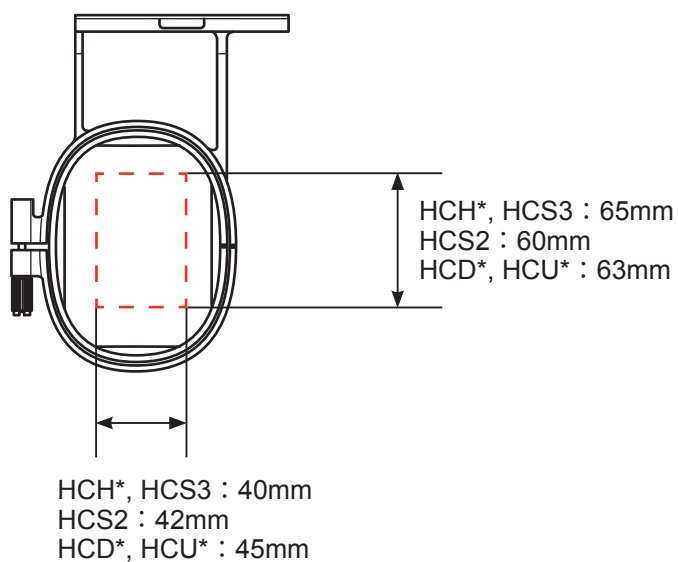
One touch frame (16X22),



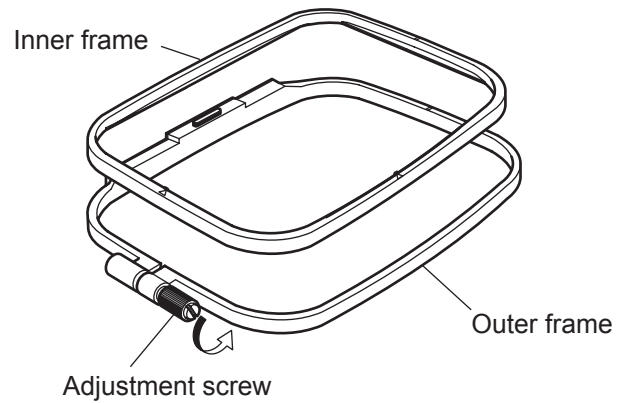
One touch frame (13X15)



One touch frame (9X6)



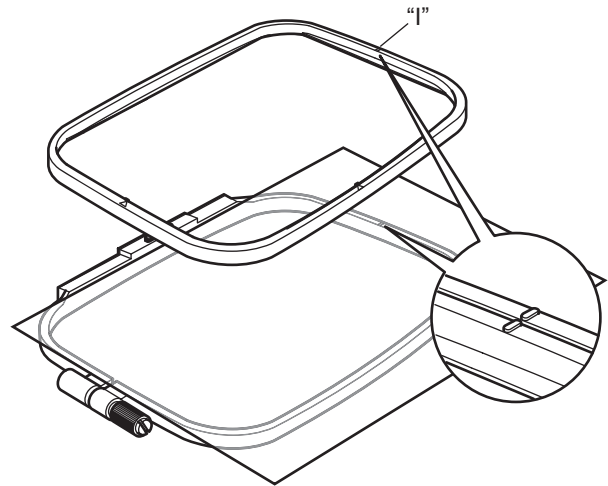
1. Loosen the adjustment screw on the outer frame and remove the inner frame.



2. Place the outer frame on flat table.



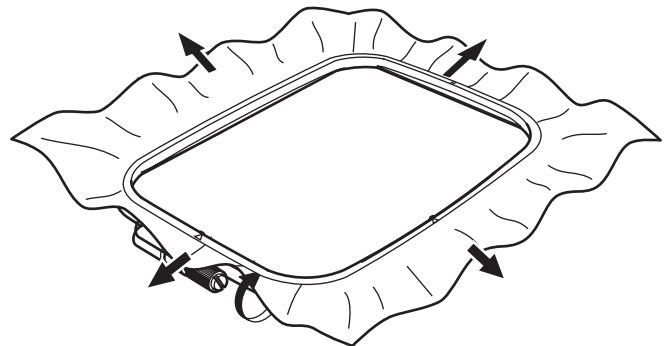
3. Set the fabric over the outer frame. Place the inner frame on the fabric and adjust the position. The outer frame and the inner frame both have "I" mark on the surface. Align the "I" mark of each. Press the inner frame from upward until the frames are even height.



4. Tighten the adjusting screw slightly and pick up the slack from fabric by pulling the fabric edge. Tighten the screw securely.

**NOTE:**

This procedure for hooping stays the same for the other type of frames.





## ●INSTALL THE FRAME BASE

### NOTE:

The procedure(1,2 and 3) is a preparation for the following frame base installation(4). It includes frame selection of PTA-32320 which moves the carriage to the closest position to the worker, but please note that it is tentative and just for positioning. For the frame actually installed, the frame selection needs to be done after base installation (5-3).

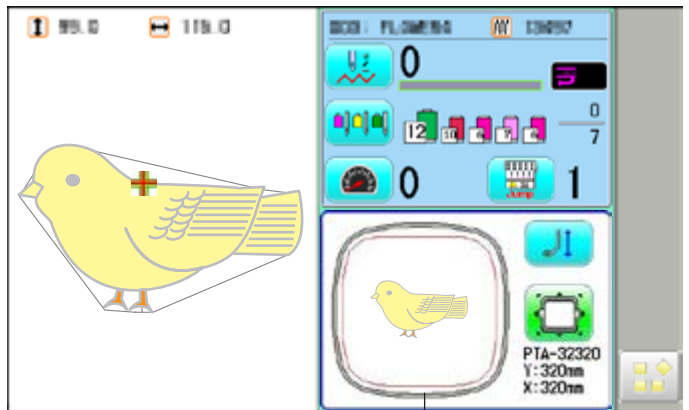
1. Turn on the power switch and the frame type currently selected will be displayed in the screen.



2. If "PTA-32320" of "Tubular square frame" is already selected, press .

Otherwise, press and select "PTA-32320" in "Tubular square frame".

The image of the frame being selected will be displayed on the operation screen.



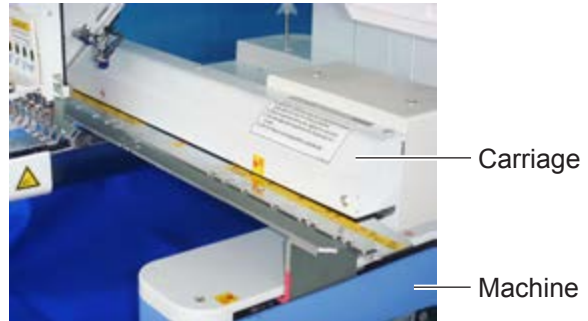
3. Press then utilize to move the carriage to the position shown in the photos below.

In case the other frame and/or frame base is installed, remove them in advance.

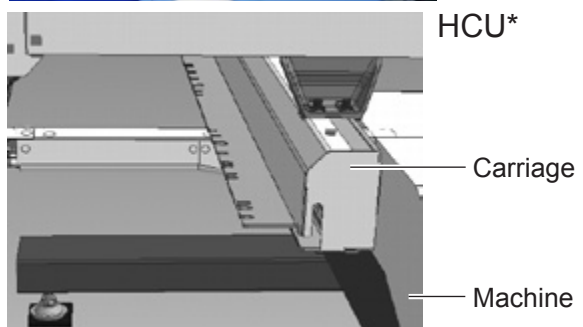
HCH\*, HCS\*



HCD\*

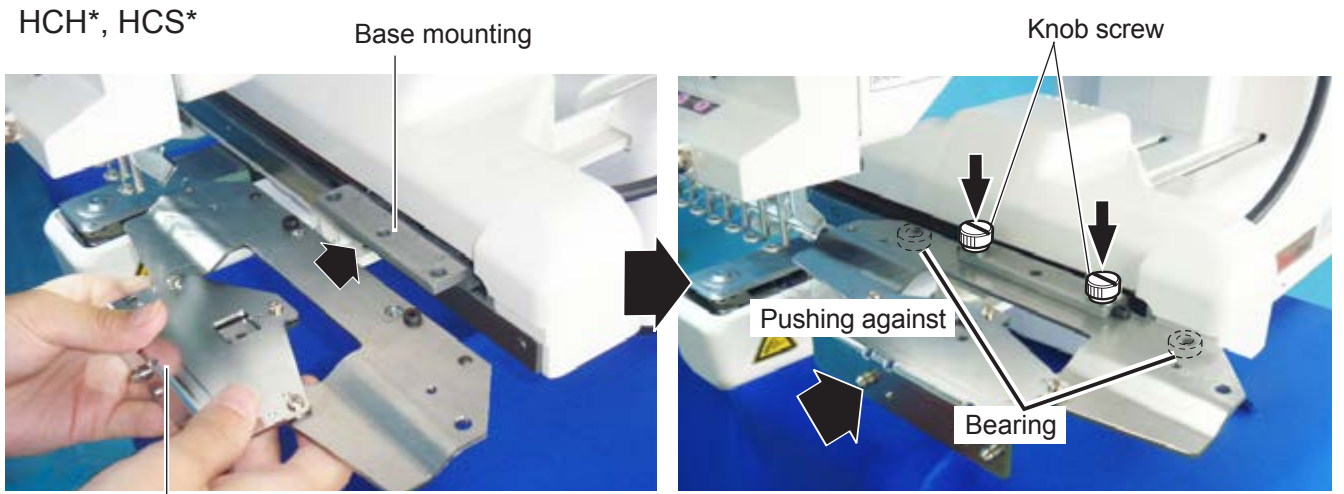


HCU\*



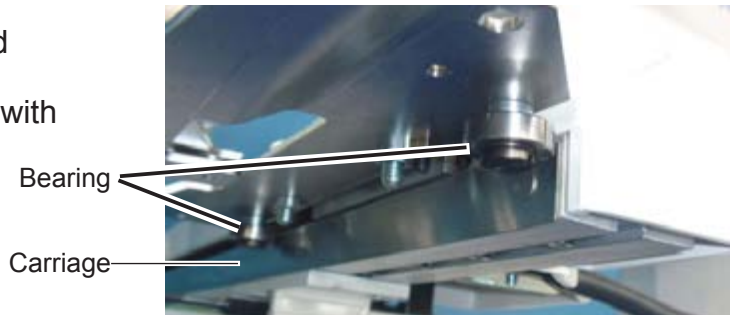
4. Insert the frame base under the mounting.

HCH\*, HCS\*

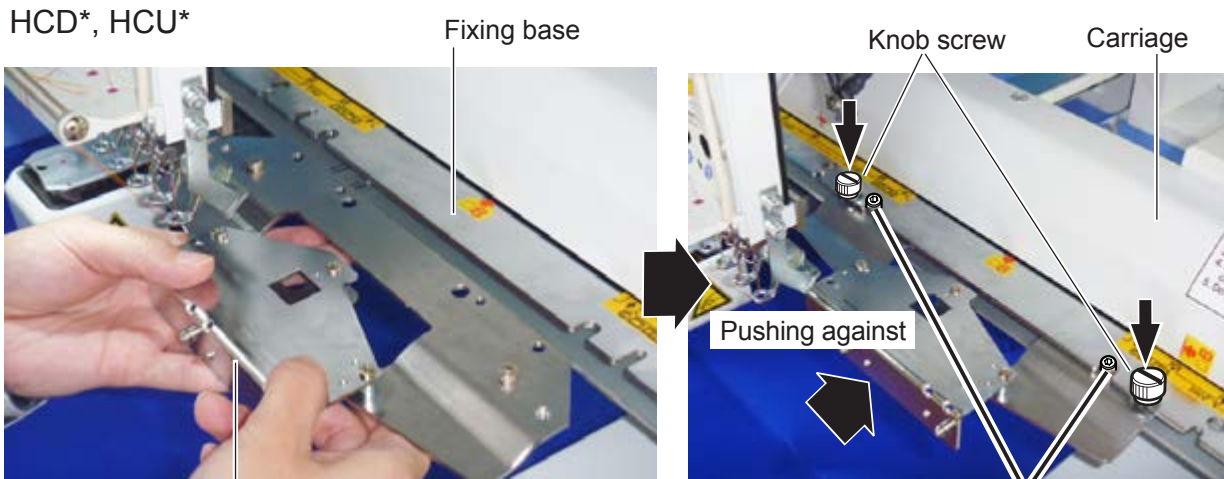


Frame base

Press the frame base to the carriage and confirm that its bearings are fitted to the carriage surface then fix the frame base with the knob screws.

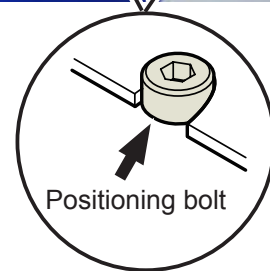


HCD\*, HCU\*



Frame base

Press the frame base to the carriage and confirm that the positioning bolts are properly fitted into the recessed area of the carriage then fix the frame base with the knob screws.





## ● SELECT A FRAME



### NOTICE:

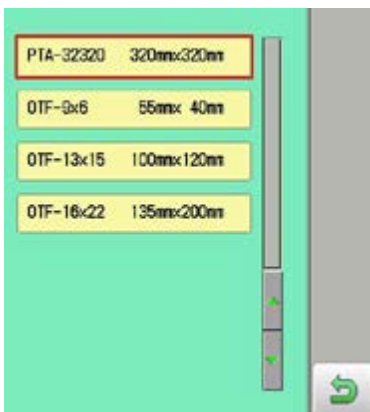
The frame type selection must be consistent with the frame actually attached to the machine. Incorrect selection will cause damage on machine and frame.

1. Press  .

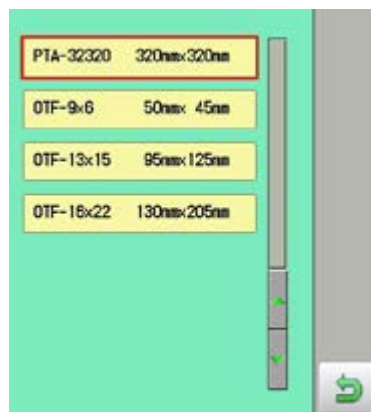
Press  “Tubular square frame”.



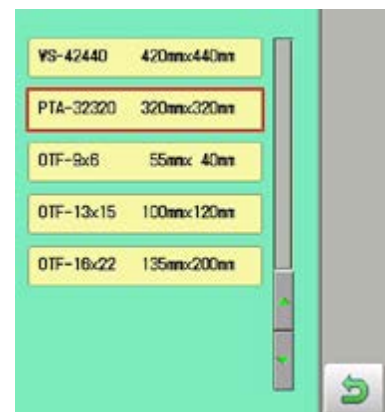
HCH, HCS3





HCS2



HCD\*, HCU\*



2. Select the frame to be set and press  .

3. Press  .

Carriage will move to the center of the embroidery area.



### WARNING:

Keep your hands away from the embroidery frame and carriage while they are moving to ensure safety and prevent damage on the machine.

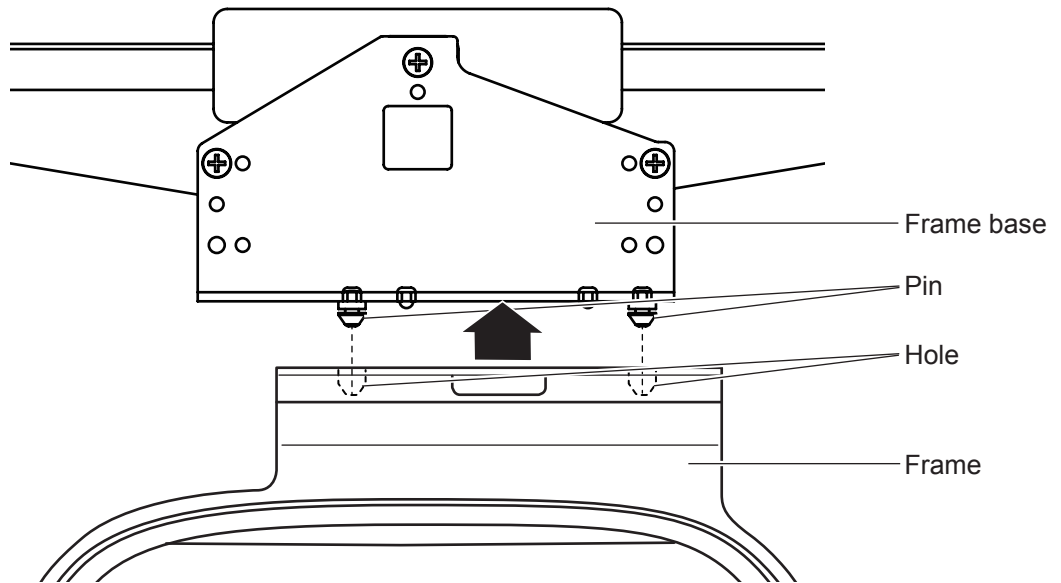


Press  to return to Drive mode.

## ● ATTACHING THE FRAME

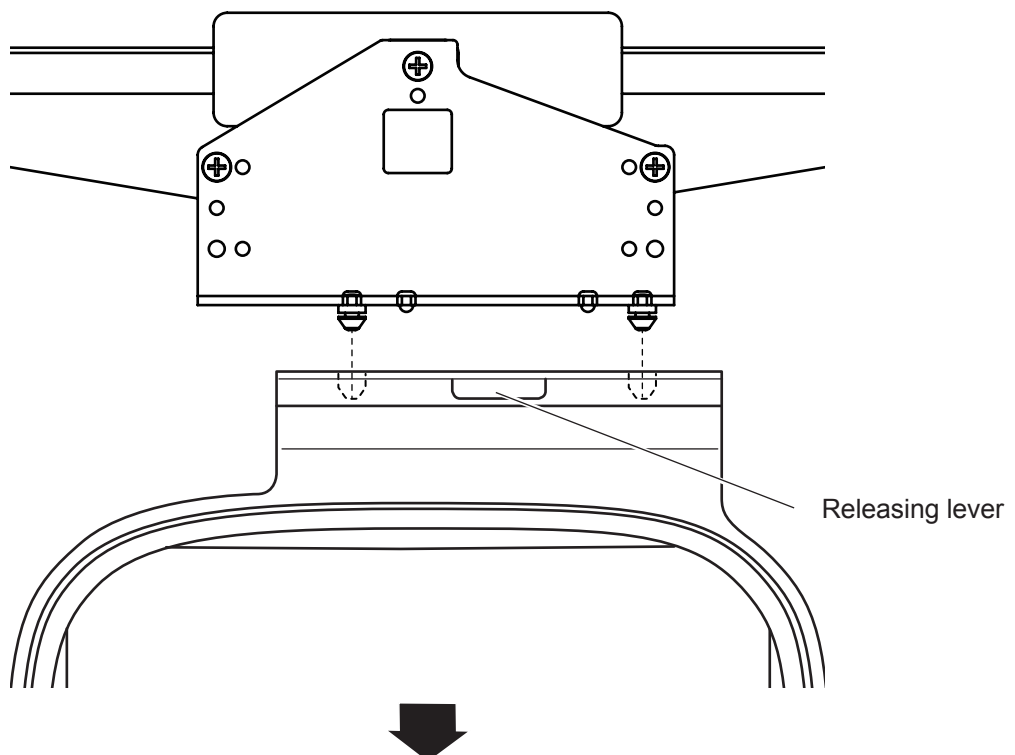
1. Turn the frame in the direction shown in the picture.
2. Insert the frame.

Set the frame on the frame base: Push the frame to the direction shown as an arrow so that the frame base pins(2) are properly set in the holes on the frame.




## ● REMOVING THE FRAME

When removing the frame from the frame base, pull the frame back while pressing the lever.



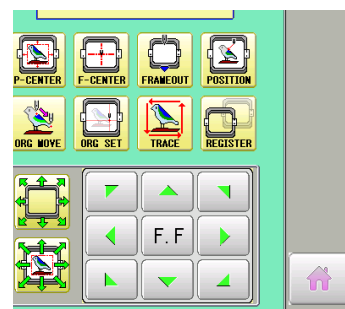
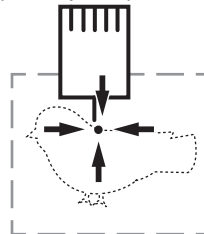
**NOTE:**

When stitching heavy cloth, place a support beneath the cloth to prevent the frame from tilting forward and maintain stitching quality.


1. Press  and move the frame to the original




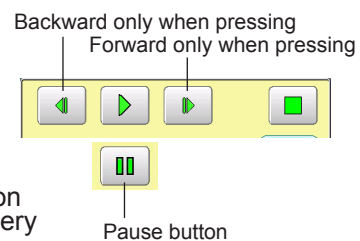
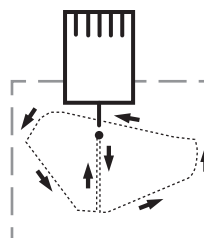
● : Original point (Start point)



2. Press 

Press  and the embroidery frame will start tracing the embroidery pattern. Confirm that pressure foot and needle do not interfere with upper arm.


Press  and the tracing will stop.



You can confirm the position and the pattern of embroidery in advance.

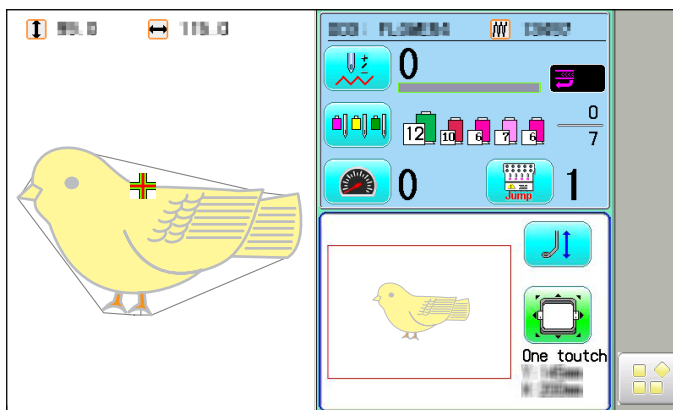
**CAUTION:**

Before start stitching, perform tracing and confirm that the embroidery frame does not interfere with pressure foot. This confirmation must be made especially when stitching thick cloth near the end of embroidery area.

3. Press  after the trace is completed.

NOTE: The embroidery frame comes back to the original point(start point) of the pattern when tracing is completed.

4. Press  and the embroidery will start.

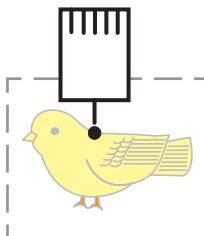


>>End

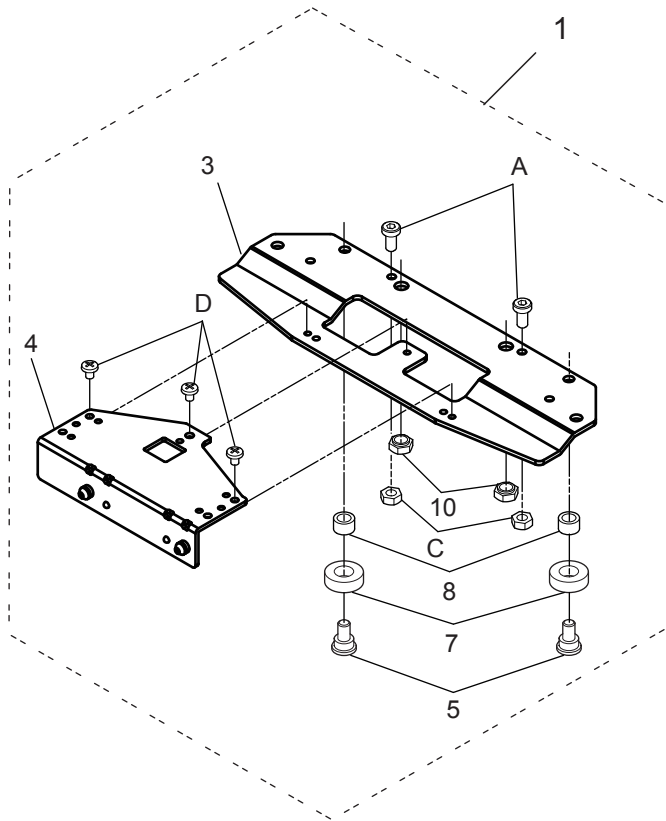
5. When embroidery is completed, the message, ">>End" will be displayed and the machine will stop.

NOTE: If the "Auto origin" function has been activated in the pattern setting, the embroidery frame returns to the original point automatically before the machine stops.

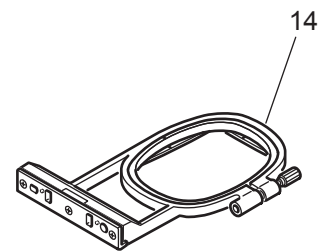
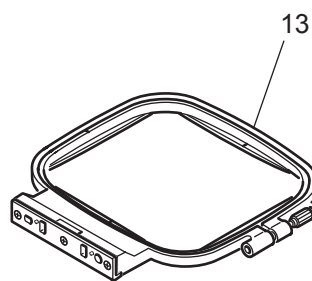
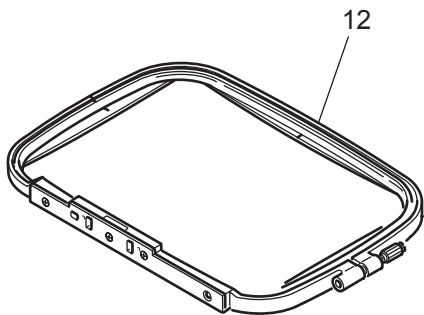
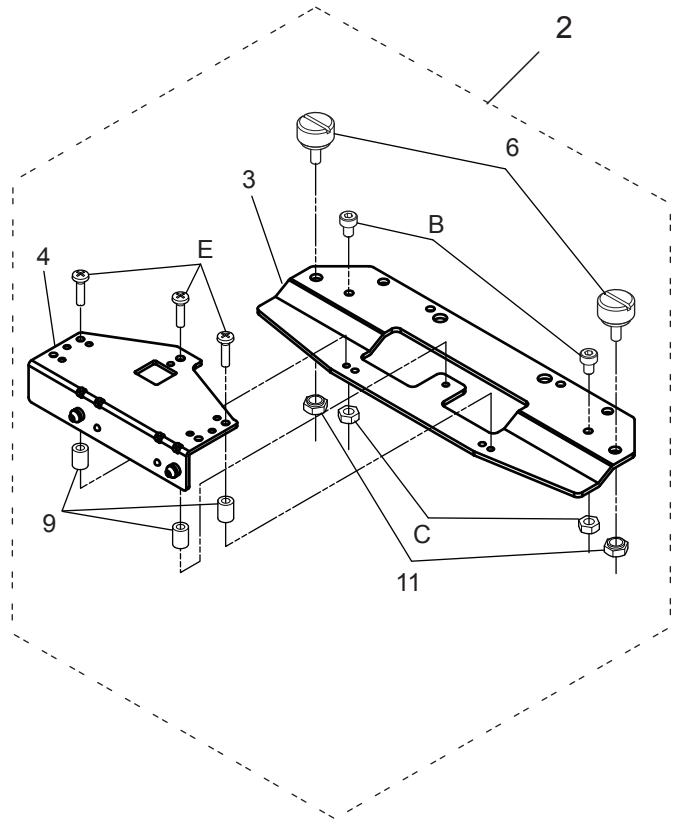
● Original point (Start point)



## HCH\*, HCS\*



## HCD\*, HCU\*



指図 Ass'y	部品番号 El't Parts No.	部品名 Parts Names	部品名	FOPC01 備考 Note
1	FRA23A00	One touch frame base for HCH*, HCS2*	ワンタッチ枠保持ベース HCH*, HCS*用	
2	FRA23A10	One touch frame base for HCD2*, HCU*	ワンタッチ枠保持ベース HCD*, HCU*用	
3	FRA23010	Connecting bracket	ワンタッチ枠連結ブラケット	
4	36023	Y carrier ass'y	Yキャリア組	
5	HCB40041	Screw	ベアリング止ネジ	
6	HCD37092	Knob screw A	ノブネジA	
7	MPB00250	Bearing	ミニチュアベアリング	
8	MPA00940	Spacer	スペーサー	
9	MPA00950	Spacer	スペーサー	
10	MPZ05170	Nut	カレイナット	
11	MPZ04270	Nut	カレイナット	
12	FRA23A20	One touch frame (16X22)	ワンタッチ枠 (16X22)	
13	FRA23A30	One touch frame (13X15)	ワンタッチ枠 (13X15)	
14	FRA23A40	One touch frame (9X6)	ワンタッチ枠 (9X6)	
A	SCAA04008	Hex socket head cap screw (M4x8)	低頭六角穴付きボルトM4 × 8	
B	SCAD04006	Hex socket head cap screw (M4x6)	六角穴付きボルトM4 × 6	
C	NHAD04000	Hex nut (M4)	六角ナット M4	
D	SBAD03004	Binding head screw (M3x4)	バインド小ねじM3 × 4	
E	SBAD03012	Binding head screw (M3x12)	バインド小ねじM3 × 12	

# HCH\*, HCS\*, HCD\*, HCU\*, HCR\*

## Tubular Sock Frame Holder

### INSTRUCTION MANUAL



FSU701-7

## IMPORTANT SAFETY INSTRUCTIONS

**0**



- Use this Manual together with Instruction Manual of embroidery machine for mounting this appliance and for operating.
- Use this appliance only for its intended use as described in this manual. Use only attachments recommended by the manufacturer as contained in this manual.
- Keep fingers away from all moving parts. Special care is required around the sewing machine needle.
- Do not pull or push fabric while stitching. It causes damage.
- Do not modify this appliance.

**SAVE THESE INSTRUCTIONS**

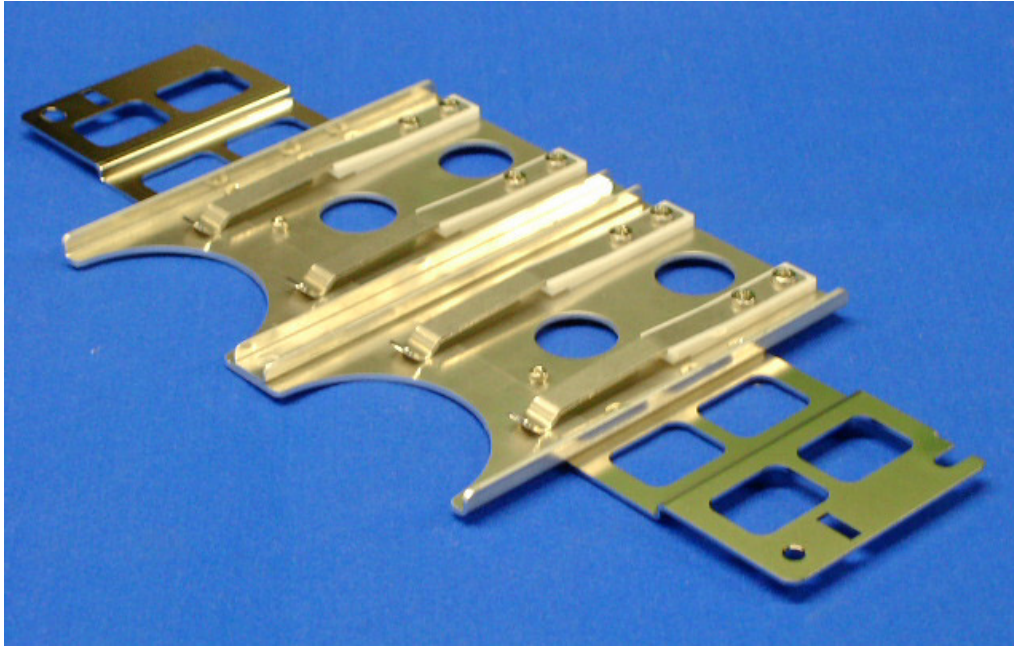


**MOUNTING**

Tubular Sock Frame Holder and Option .....	1-1
Assemble Frame Holder .....	1-2
HOOPING SOCK .....	2-1
Preparation of PATTERN data .....	3-1
SOCK FRAME SETTINGS .....	4-1
STARTING TO SEW .....	5-1

## ● Tubular Sock Frame Holder and Option

FRA20A00  
Tubular Sock Frame Holder



Fit on arm of Tubular frame bracket which has 360 mm interval.

2 pcs of Sock frame (adult) can be set in one time.

### Option

FRA20010  
Sock Frame(Adult)



Inner diameter:  
78 x 57 (mm)

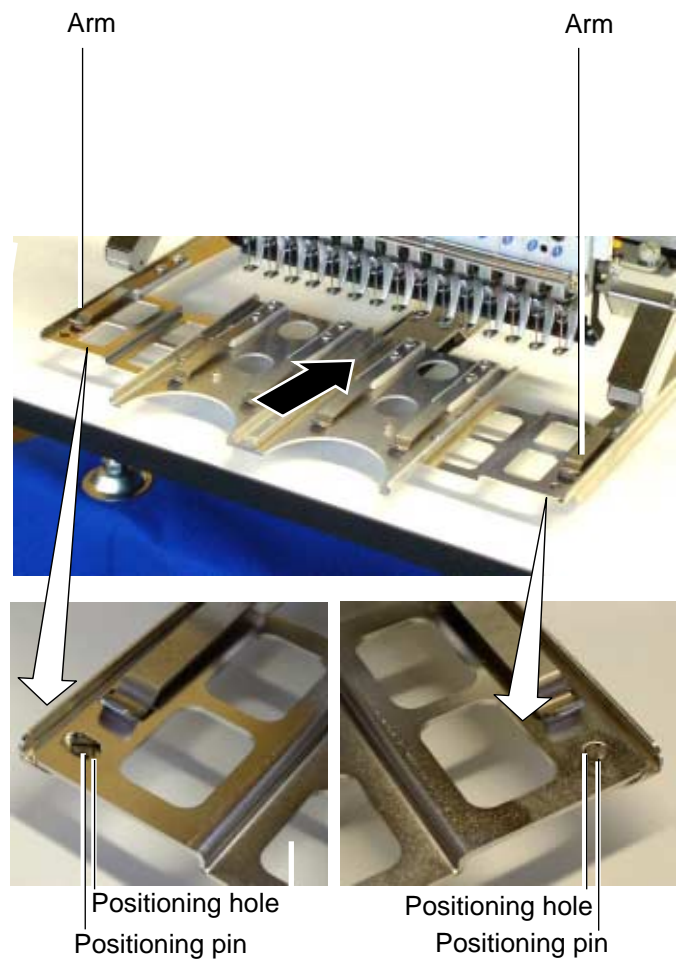
FRA20030  
Sock hooping board (Adult)



Use for setting sock  
on Sock frame.

## ● Assemble Frame Holder

1. Mount Tubular frame bracket on machine.  
To use border table is recommended. (Please refer to Instruction manual of machine)
2. Set Tubular sock frame holder to arm of Tubular frame bracket.



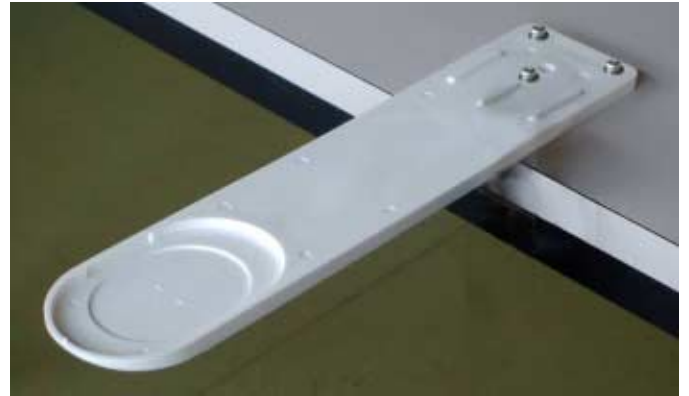
Make sure that the holder pins are inserted into the positioning holes of the Tubular Sock Frame Holder on each side.

# HOOPING SOCK

2-1

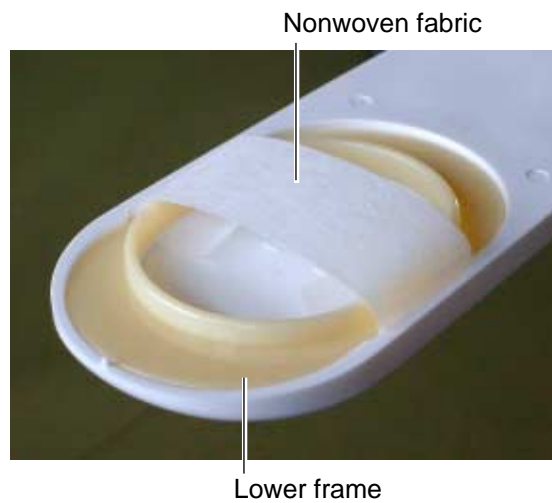
1. Place Sock hooping board securely on sturdy work bench.

In case you can not use screws for work bench because of material type, please use clamp.



2. Put Nonwoven fabric on Lower frame and set to Sock hooping board.

Please set edge of Nonwoven fabric between Lower frame and Sock hooping board.

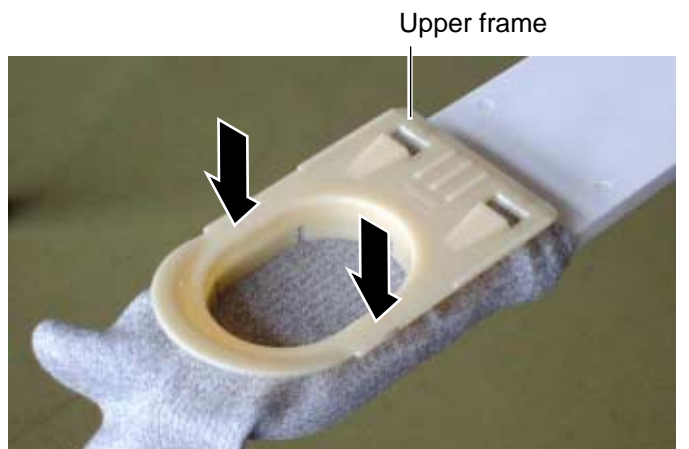


3. Open entrance of sock and set to Sock hooping board.

Please check position of Nonwoven fabric.



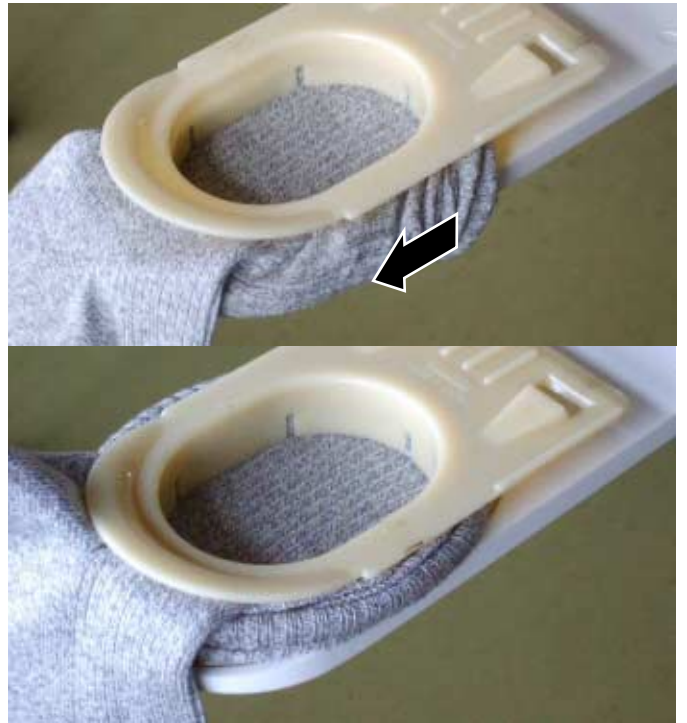
4. Set Upper frame from top and press. Sock should be banded by Upper and Lower frame firmly.



# HOOPING SOCK

2-2

5. Pull entrance of sock to front and locate between Upper and Lower frame.



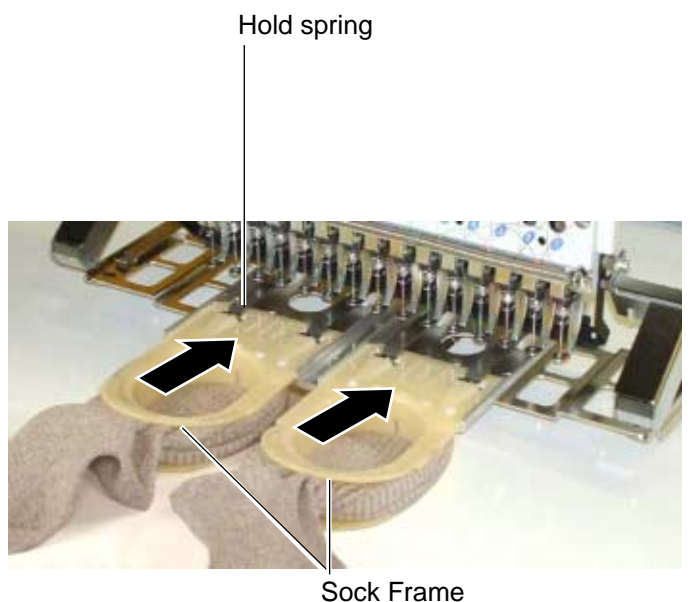
6. Take Sock frame out from Sock hooping board.



7. Set Sock frame to Tubular sock frame holder

Insert Sock frame up to the position of stopper on Holder.

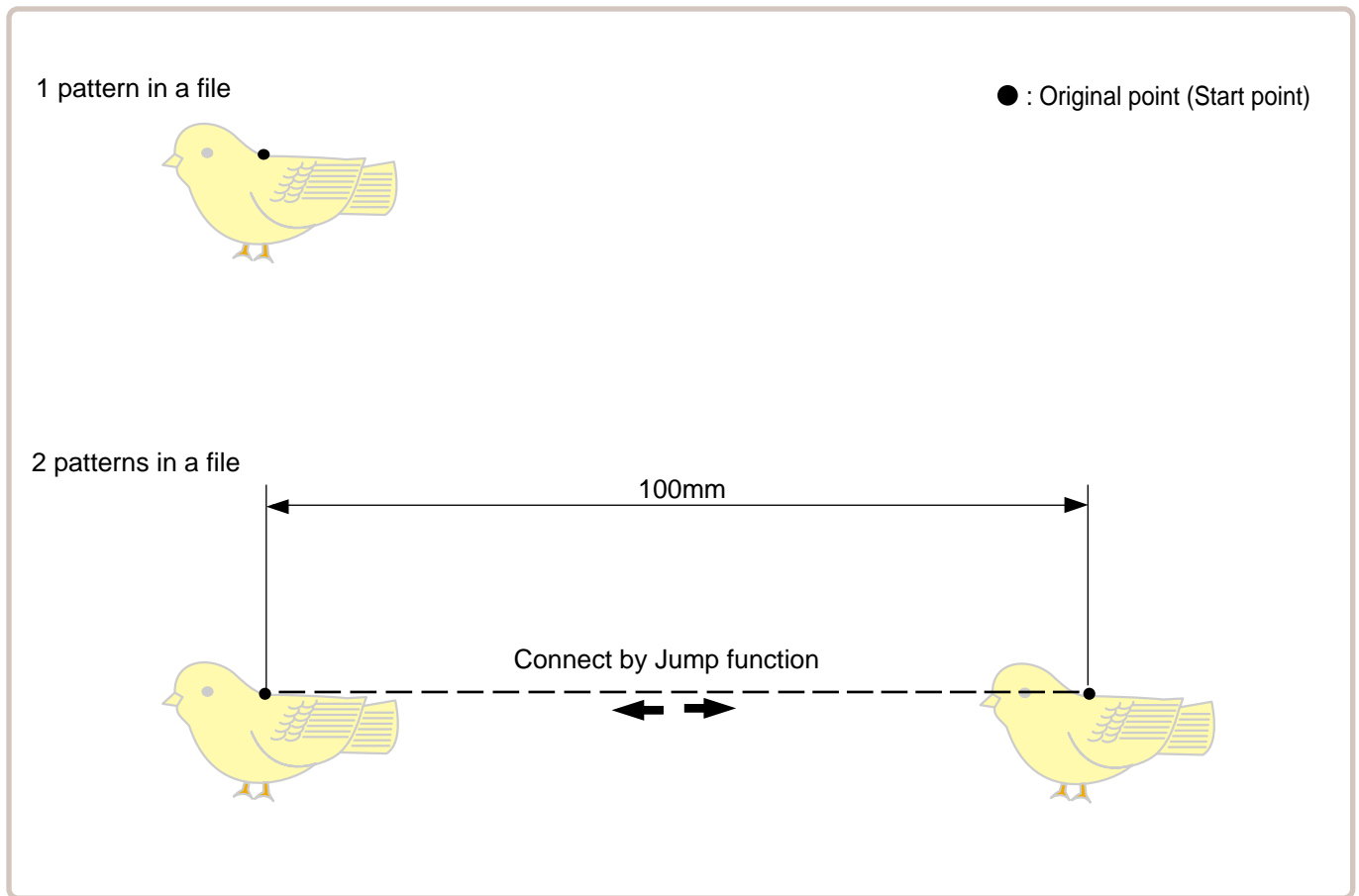
Please confirm that Hold springs of Holder enter into square holes of Sock frame.




# PREPARATION OF PATTERN DATA

3-1

Please prepare design data with the following conditions.



- Size of 1 pattern should be smaller than embroidery area of Sock frame.  5-2
- In case you make 2 patterns in a file, distance should be 100mm and connect by Jump function. Origin point can be on right or left pattern.

# SOCK FRAME SETTINGS

# 4-1

When you use Frame, please make machine setting according to frame type selected.



## CAUTION: To avoid problems.


The machine and frame may be damaged if the incorrect frame settings are used.

1. When the machine is stopped, press



2. Select "FRAME".




3. Select  "Sock frame".



Change the type of frame.



4. Select desired size of frame and press .

The embroidery area appear in red.



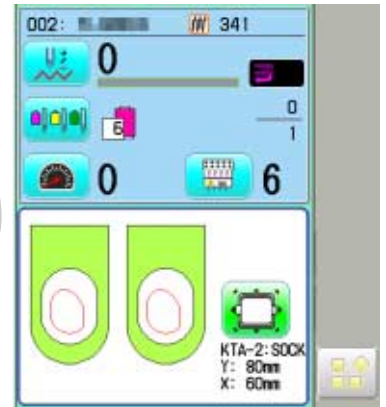
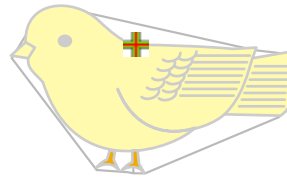
# SOCK FRAME SETTINGS

# 4-2

5. Press 

Sock frame will be shown in the lower right corner of the screen.  
Then Sock frame will be set.

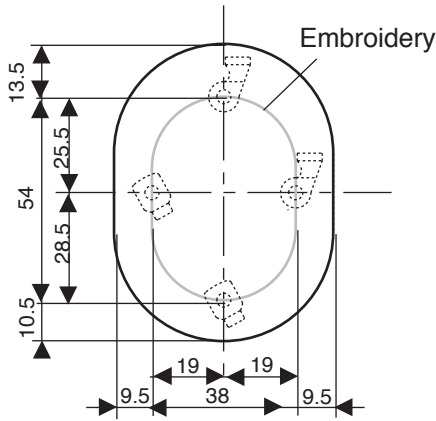
 26.0  23.0



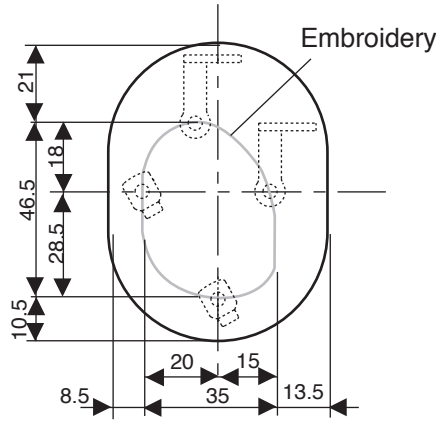


Embroidery area is limited by model of machine.

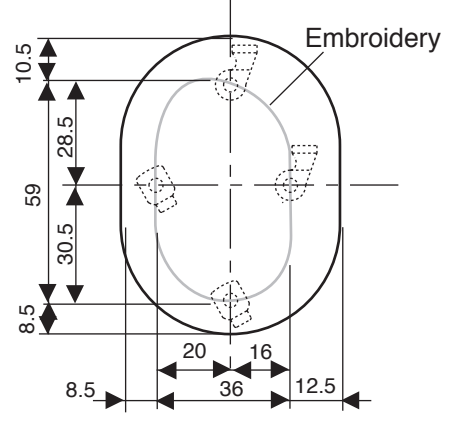
HCD\*,HCU\*,HCR\*



HCS2



HCH\*, HCS3



Unit : mm

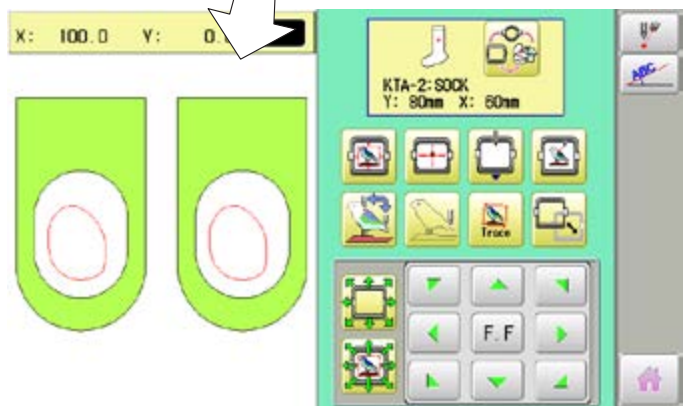
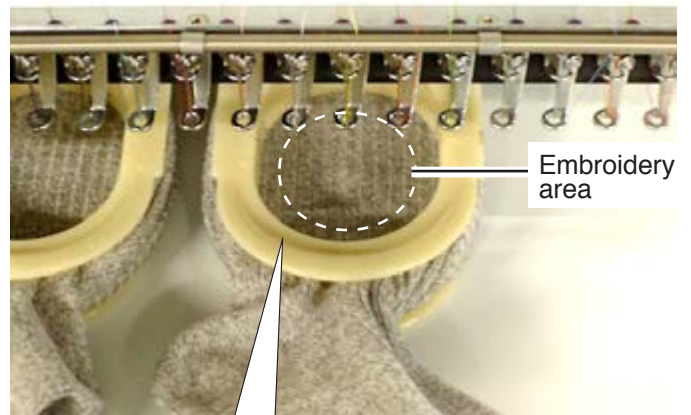
1. Press  and Press .


The embroidery frame will move to the center of the embroidery area automatically.



**CAUTION: To prevent accidents.**


The frame moves quickly.  
Keep hands away from the frame.



2. Press  and move the frame to the original

point of pattern data by .

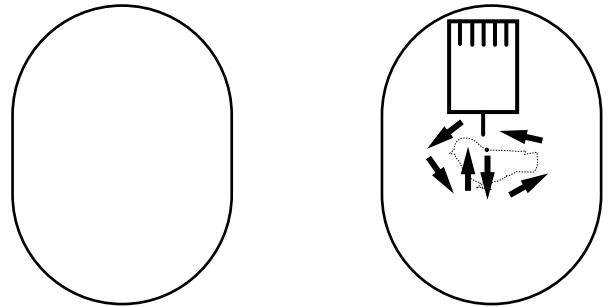
3. Press .

When you Press , the frame will start moving for the design trace. Make sure that the pressure foot and needle does not touch the frame.

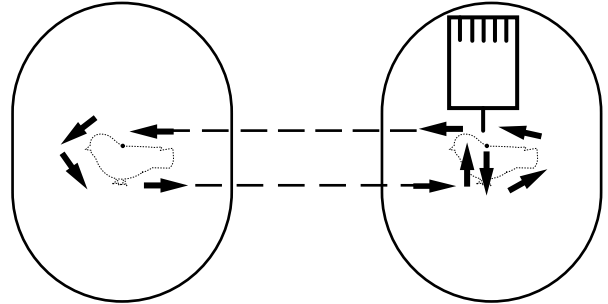
When you Press , the machine will stop.

Go on to step 4 if you want to start embroidering without tracing first.


1 pattern in a file



2 patterns in a file

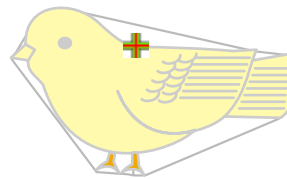


The embroidering frame will return to the first stitch point of the pattern.

4. Press , the design trace finished.

The frame will return to the original point.

 26.0  23.0




5. Press .

Embroidery will start.

6. After finishing your design, the display will show ">>End" and the machine will stop.

>>End

For 1 pattern in a file, Machine will stop at the end of pattern.

When press  button, frame moves another side and start embroidery.





## HappyJapan Inc.

HEAD OFFICE 3-3515, Tachiyagawa, Yamagata-city, 990-2251, Japan  
Phone: +81-23-686-2272 Fax: +81-23-686-2243

TOKYO OFFICE 2-9-5, Taito, Taito-Ku, Tokyo 110-0016, Japan  
Phone: +81-3-3834-0711 Fax: +81-3-3835-8917