

ENGLISH

NA-11UT Series
Service manual

CONTENTS

1. JAM·CLEARANCE	8
1-1. Needle Bar Jam	8
1-2. Thread Take-up Lever Clearance	10
2. FEED TIME	12
2-1. Adjusting the Height of the Feed Dog	12
2-2. The Up/Down Motion Adjusting Shaft Setting	14
2-3. The Presser Foot Setting	16
2-4. The Feed Cam and Presser Foot Up/Down Motion Cam Setting	19
2-5. Adjusting the Motion Range of the Feed Dog	20
2-6. Adjusting the Balance of the Feed Dog	22
3. THREAD TRIMMING TIME	23
3-1. The Thread Bar Highest/Lowest Stop Position Setting	23
3-2. Replacement of the Mes and the Setting	25
3-3. The Thread Retainer Setting	29
3-4. The Thread Trimming Cam Setting	30
4. BAD SEWING	31
4-1. Hook Time	31
4-2. Placing the Upper Thread	34
4-3. Adjusting the Tension of the Upper Thread	35
4-4. Adjusting the Tension of the Presser Foot	36
4-5. Adjusting the Tension of the Lower Thread	37
5. NOISE	38
5-1. Upper Shaft Collar Clearance	38
5-2. Standing Shaft Clearance	40
5-3. Lower Shaft Clearance	42

6. OIL SUPPLY	43
6-1. Oil Supply	43
6-2. Adjusting the Oil Supply Volume for the Thread Take-up	45
6-3. Adjusting the Oil Supply to the Hook	46
7. SOLENOID	47
7-1. Thread Trimming Solenoid	47
8. ADJUSTING THE FORWARD/BACKWARD STITCH LENGTH	49
8-1. Adjusting the Delicate Adjusting Shaft	49

01

JAM · CLEARANCE 负荷 · 间隔

1-1

Needle Bar Jam / 针杆负荷

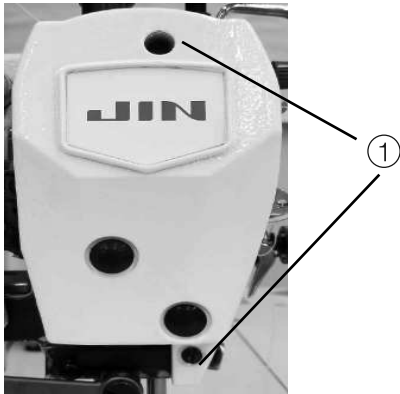

[Fig. 1]

- ▶ Loosen the screw① for the face plate and disassemble the fact plate from the arm.
- ▶ 松开面板固定螺丝①后, 拆卸面板。

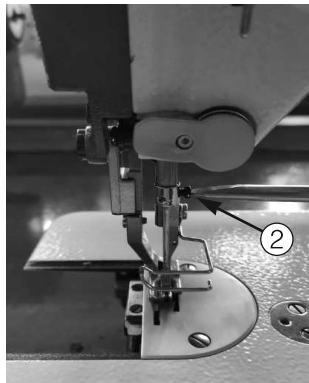

[Fig. 2]

- ▶ Loosen the fixing screw② for the needle and disassemble the needle from the needle bar.
- ▶ 松开机针固定螺丝②后, 分离针杆上的针。

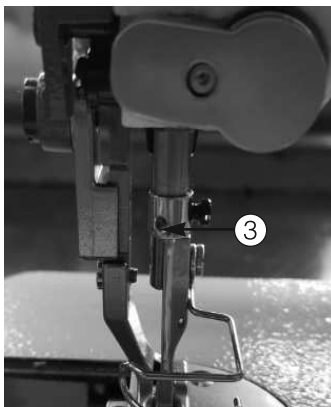
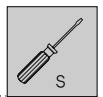

[Fig. 3]

- ▶ Disassemble the needle bar thread guide③ from the needle bar.
- ▶ 从针杆分离针杆挂线器③。

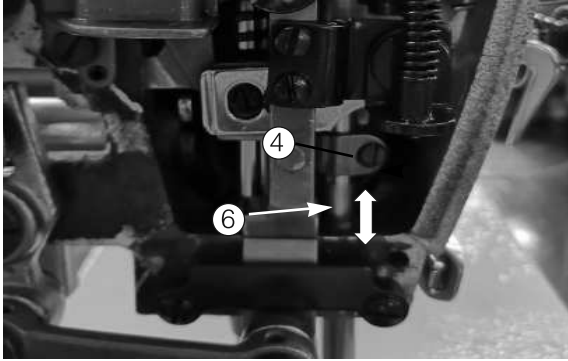

[Fig. 4]

- ▶ Loosen the fixing screw④ for the needle bar. Move the needle bar ⑥ up and down to check the jam.
- ▶ 松开针杆固定螺丝④，上下移动针杆⑥，确认间隔。

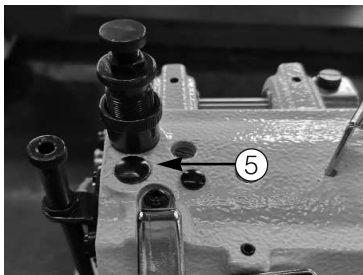
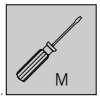

[Fig. 5]

- ▶ If the needle bar is stuck, remove the rubber cap ⑤ of the needle bar upper bushing.
- ▶ 如果针杆过紧，解除针杆上套管橡胶盖⑤。

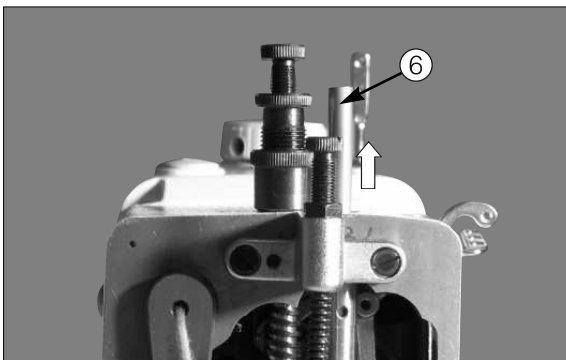

[Fig. 6]

- ▶ Disassemble the needle bar⑥ in the direction of the upper bushing and replace it with a new SunStar needle bar.
- ▶ 上套管方向分离针杆⑥，然后更换正品针。
- ▶ Make the assembly in the reverse order of the disassembly.
- ▶ 根据拆卸逆顺序进行组装。

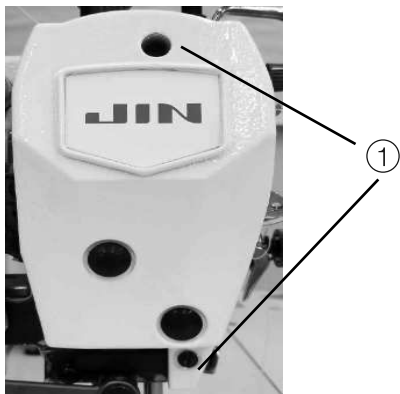

[Fig. 1]

- ▶ Loosen the screw① for the face plate and disassemble the face plate.
- ▶ 松开面板固定螺丝①，拆卸面板。

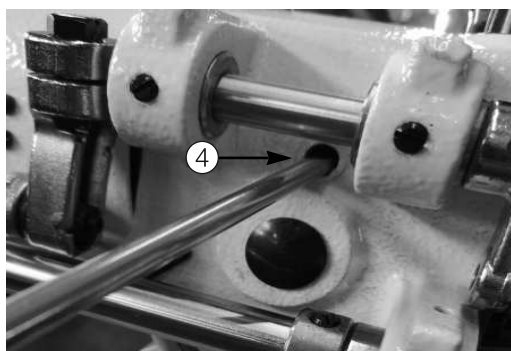

[Fig. 2]

- ▶ Remove the rubber cap from the arm hole. Insert the driver to loosen the screw④ for the thread take-up lever hinge pin by turning it full circle.
- ▶ 拆卸臂床孔的橡胶盖，插入扳手后，松一圈挑线器铰链销固定螺丝④。

- ▶ Be cautious not to turn the cutting part of the screw for the thread take-up lever hinge pin.
- ▶ 注意挑线器铰链销固定螺丝面不能转动。

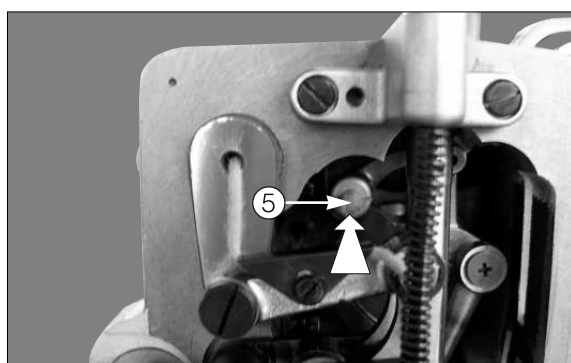

[Fig. 3]

- ▶ Smoothly press the thread take-up lever hinge pin⑤ in the direction of the arm bed and tighten the screw④ for the hinge pin.
- ▶ 臂床方向轻轻按挑线器铰链销⑤，然后拧紧铰链销固定螺丝④。

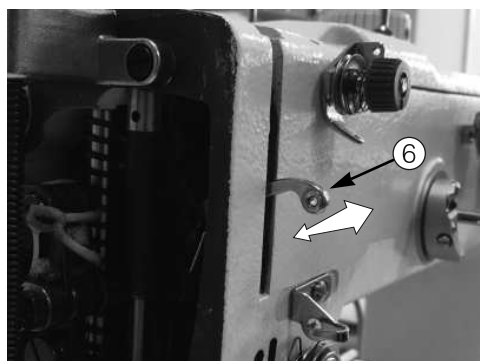

[Fig. 4]

- ▶ Slightly move the thread take-up⑥ left and right to check the clearance.
- ▶ 左右轻轻晃动挑线器⑥，确认间隔。



[Fig. 5]

- ▶ Manually turn the pulley⑦ to check whether there is no jam and it operates smoothly.
- ▶ 手动转动手轮⑦，然后确认是否无负荷顺利运行。

- ▶ Make the assembly in the reverse order of the disassembly.
- ▶ 根据拆卸逆顺序进行组装。

02

FEED TIME 传送时机

2-1

Adjusting the Height of the Feed Dog / 送布牙高度调整

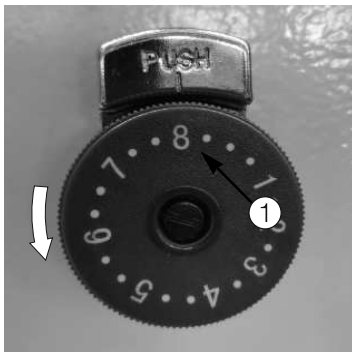

[Fig. 1]

▶ Turn the dial ① in the direction of the arrow and set it at the maximum stitch length.

▶ 箭头方向转动表盘①，调到最大针距。

▶ Max. stitch length: : 8mm

▶ 最大针距 : 8mm

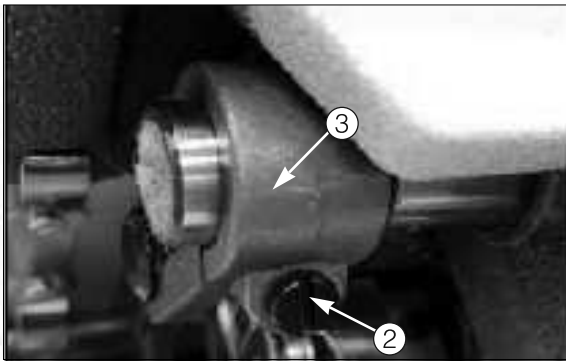

[Fig. 2]

▶ Lay down the machine and loosen the screw② for the feed lift shaft crank (ass'y)③.

▶ 横放机械后，松开提杆曲柄(前)③固定螺丝②。

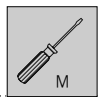

[Fig. 3]

▶ Set the height④ of the feed at standard 1.2mm when the needle bar is at the highest point.

▶ 调整在针杆最高点的送布牙，使高度④成为1.2mm标准高度。

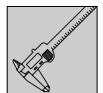

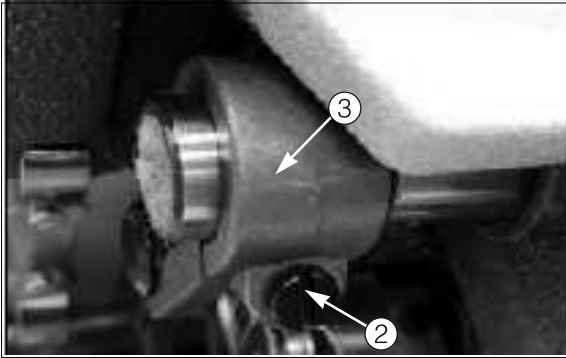

[Fig. 4]

- ▶ Tightly tighten the screw② for the feed lift shaft crank (ass' y)③.
- ▶ 拧紧提杆曲柄(前)③固定螺丝②。

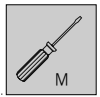

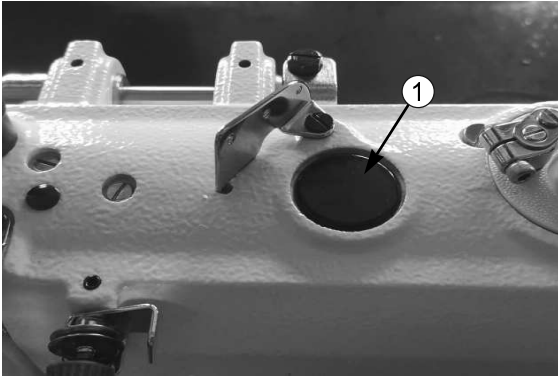

[Fig. 1]

- ▶ Remove Rubber Plug 1.
- ▶ 拆除橡胶塞1。

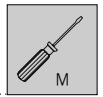

[Fig. 2]

- ▶ Turn the inner pressure foot into contact with the needle plate.
- ▶ 将内压脚转至与针板接触。

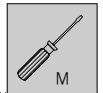

[Fig. 3]

- ▶ Adjust the CAM to 2-3mm from the needle plate.
- ▶ 调整凸轮，机针至距离针板2-3mm。

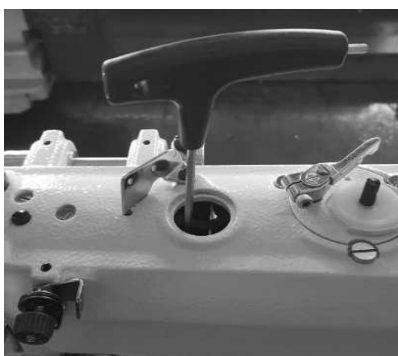

[Fig. 4]

- ▶ Locking Cam screw.
- ▶ 锁紧凸轮螺钉。

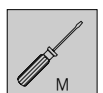

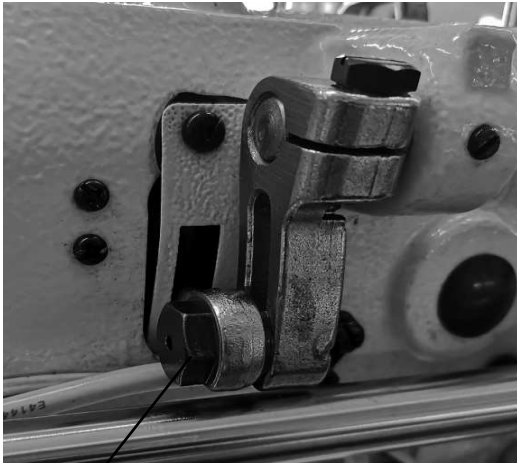

[Fig. 5]

A

▶ The position of screw a shall be adjusted to the lowest position during installation.

▶ 安装时，须将A螺钉位置调整在最低位置。

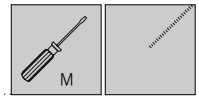

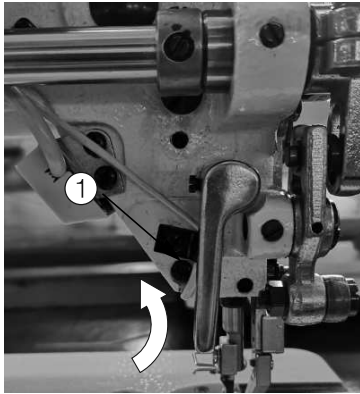

[Fig. 1]

- ▶ Turn the presser foot lifter ① in the direction of the arrow to lift the presser foot.
- ▶ 箭头方向转动压杆提升器①，提升压脚。

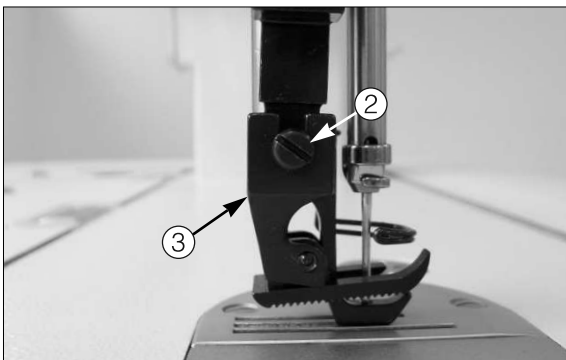

[Fig. 2]

- ▶ Loosen the screw ② for the main presser foot and disassemble the presser foot ③.
- ▶ 松开主压脚固定螺丝②，分离压脚③。

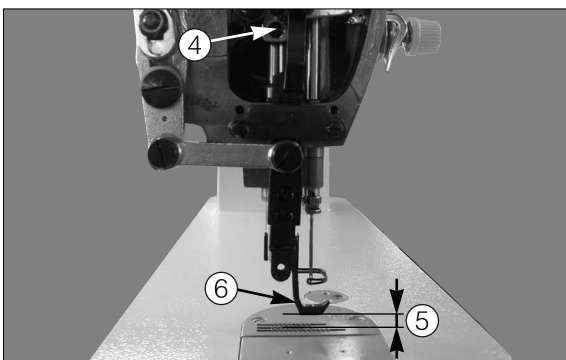
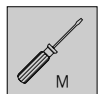

[Fig. 3]

- ▶ Loosen the screw ④ for the presser bar holder. Set the height ⑤ of the auxiliary presser foot ⑥ at 8 mm, and tightly tighten the screw for the presser bar holder.
- ▶ 解开压杆把固定螺丝④，调整辅助压脚⑥，使高度⑤成为 8 mm，然后拧紧压杆把固定螺丝④。

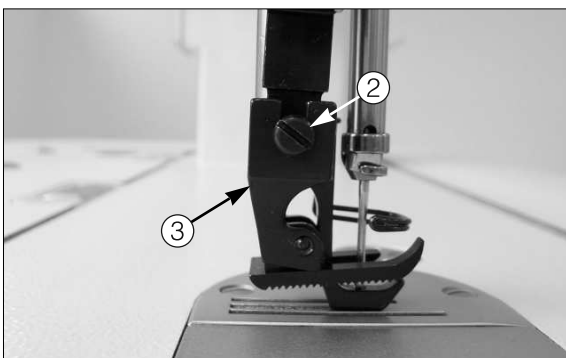

[Fig. 4]

- ▶ Insert the main presser foot ③ and tighten the screw ② for presser foot.
- ▶ 插入主压脚③后，拧紧压脚固定螺丝②。

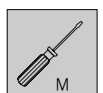



[Fig. 5]

- ▶ Turn the pulley to set the needle bar⑧ at the highest point.
- ▶ 正旋转手轮，使针杆⑧位于最高点。

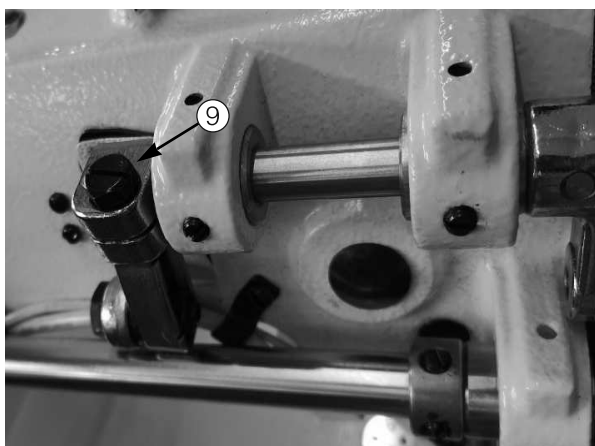

[Fig. 6]

- ▶ Loosen the screw ⑨ for the auxiliary presser foot up/down motion crank.
- ▶ 解开辅助压脚上下运动曲柄固定螺丝⑨。

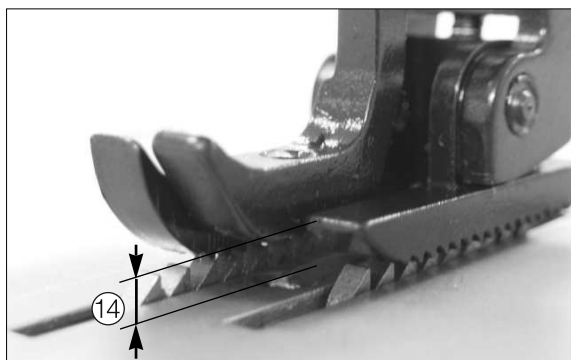

[Fig. 7]

- ▶ Adjust the height⑭ of the auxiliary presser foot to be 3mm from the upside face of the needle plate.
- ▶ 调整辅助压脚底面和针板上表面，使间距⑭成为3mm。



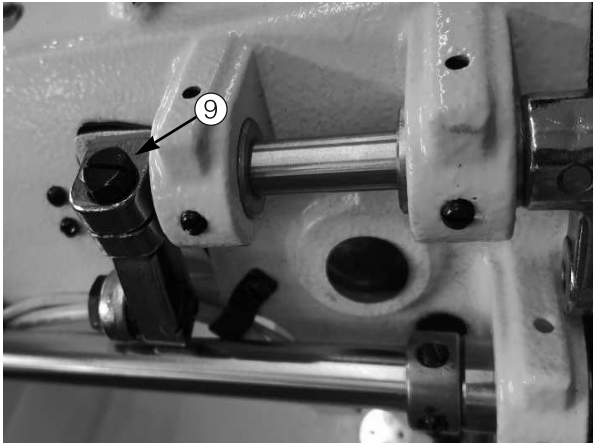

[Fig. 8]

- ▶ Adjust the height of the auxiliary presser foot at 3mm, and tighten the up/down crank screw⑨.
- ▶ 把辅助压脚高度调到3mm, 然后拧紧上下运动曲柄螺丝⑨。



2-4

The Feed Cam and Presser Foot Up/Down Motion Cam Setting / 送布牙凸轮以及压脚上下运动凸轮安装

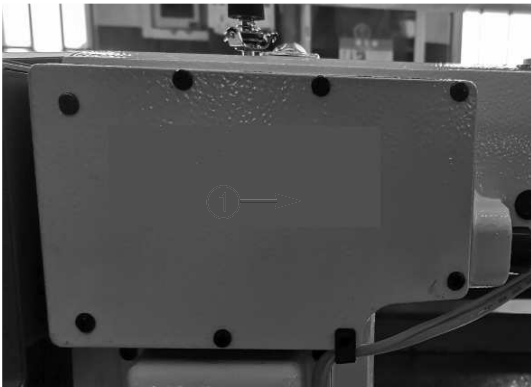

[Fig. 1]

- ▶ Disassemble the top cover①.
- ▶ 分离面盖①。

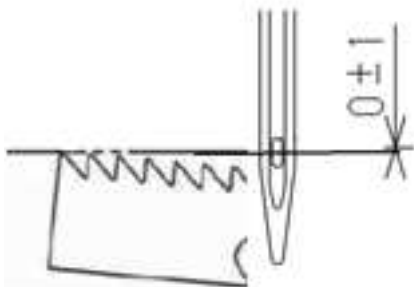

[Fig. 2]

When the feeding distance dial is set at the maximum position, when the feeding tooth drops from the highest position, the center of the machine pinhole should be at the same level as the front 1-2 teeth of the feeding tooth on the surface of the needle plate

送料距旋钮刻度设置在最大位置时，当送布牙从最高位置下降，机针孔中心应与针板上表面送布牙前端1-2齿在同一水平上

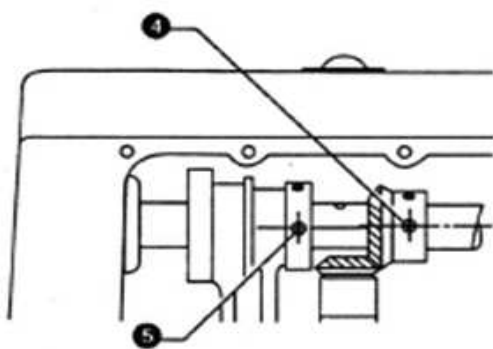

[Fig. 3]

On the basis of the second fixed 4 of the upper shaft gear, the third fastening screw 5 center of the Tooth Lifting Cam will align the 4 center slightly downward.

以上轴齿轮第二只固定④为基准，抬牙凸轮的第三只紧固螺钉⑤中心，将对齐④中心，稍微向下偏一点。

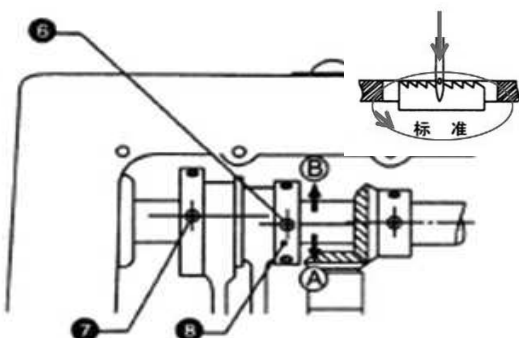
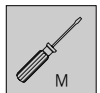

[Fig. 4]

- ▶ Continue to turn the upper wheel counterclockwise, with the lifting Cam 8 second fastening screw 6 as the base, the cloth feed Cam's third fastening screw 7 center, will align 6 center, slightly upward offset

- ▶ 继续逆时针转动上轮，以抬牙凸轮⑧第二只紧固螺钉⑥为基准，送布凸轮的第三只紧固螺钉⑦中心，将对齐⑥中心，稍微向上偏一点。



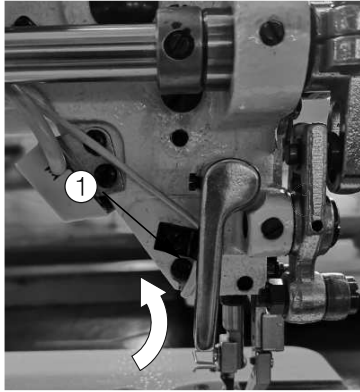

[Fig. 1]

- ▶ Lift the presser foot by turning the presser bar lifter ①.
- ▶ 转动压杆提升器①，提升压脚

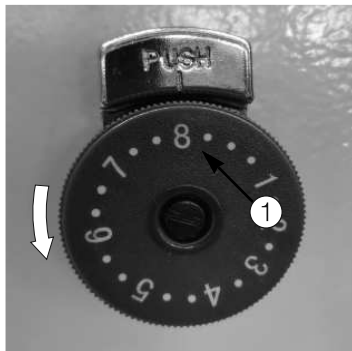

[Fig. 2]

- ▶ Turn the dial ② in the direction of the arrow and set the stitch length at the maximum level (8mm).
- ▶ 箭头方向转动表盘②，调到最大针距(8mm)。

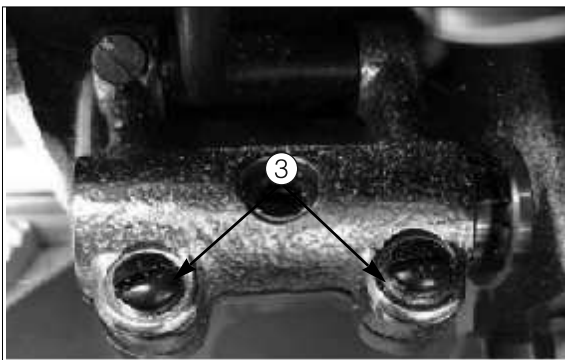

[Fig. 3]

- ▶ Loosen the screw ③ for the feed dog support base by turning it full circle.
- ▶ 松1圈送布牙支撑曲柄固定螺丝③。

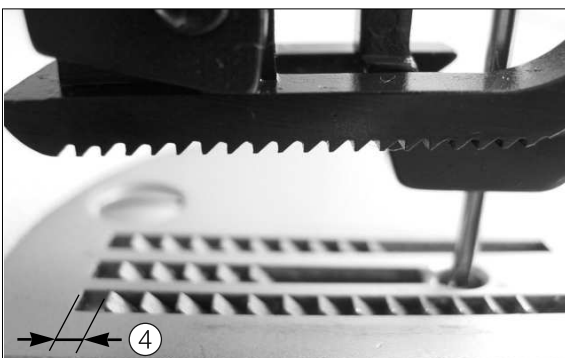
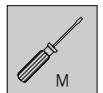

[Fig. 4]

- ▶ Manually turn the pulley. When the needle descends and the center of the thread hole of the needle meets the face of the needle plate, set the distance ④ between the back of the feed and the feed dog groove at 2mm.
- ▶ 手动转动手轮，机针降低，使针板面移到针孔中央，然后调整送布牙后面和送布牙槽，使间距④成为2mm。

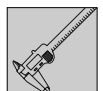

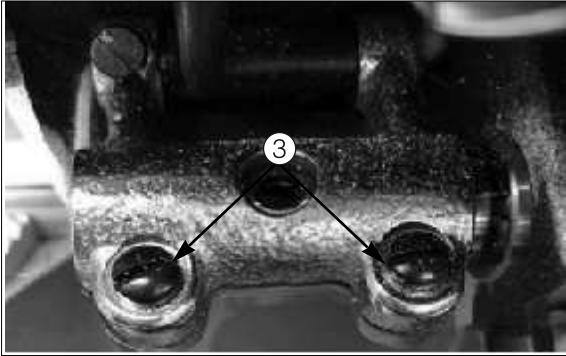

[Fig. 5]

- ▶ Tighten the screw ③ for the feed dog support crank.
- ▶ 拧紧送布牙支撑曲柄固定螺丝③。

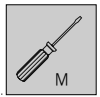

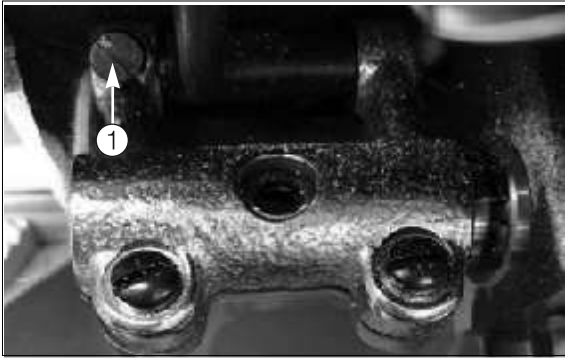

[Fig. 1]

- ▶ Loosen the fixing screw① for the feed dog support shaft.
- ▶ 松开送布牙支撑轴固定螺丝①。

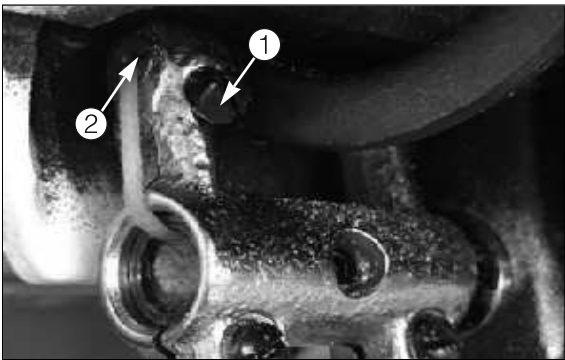
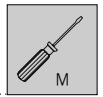

[Fig. 2]

- ▶ When the feed dog is at the highest position, turn the feed dog turning shaft② to make the upside face of the feed dog horizontal with the needle plate.
- ▶ 转动送布牙最高点时送布牙支撑轴②，使送布牙上面针板和针板保持水平。

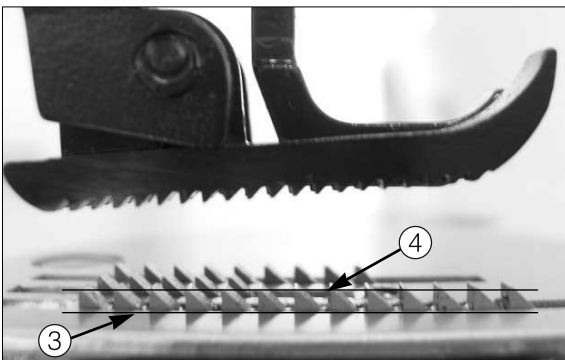
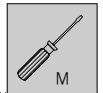

[Fig. 3]

- ▶ Adjust the upper face③ of the needle plate and the upper face④ of the feed dog to be horizontal.
- ▶ 调整针板上面③和送布牙上面④，使之保持水平。



[Fig. 4]

- ▶ Tighten the fixing screw ⑤ for the feed dog support shaft.
- ▶ 拧紧送布牙支撑轴固定螺丝⑤。

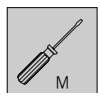

03

THREAD TRIMMING TIME 切线时机

3-1

The Thread Bar Highest/Lowest Stop Position Setting / 针杆上下停止位置安装



①

[Fig. 1]

- ▶ Press the switch ① and check the highest/lowest stop position.
- ▶ 按开关①，确认针杆上下停止位置。

- ▶ Highest stop position: Press the switch once.
- ▶ Lowest stop position: Press the switch twice in a row.
- ▶ 上停止：按1号开关。
- ▶ 下停止：按2次开关。

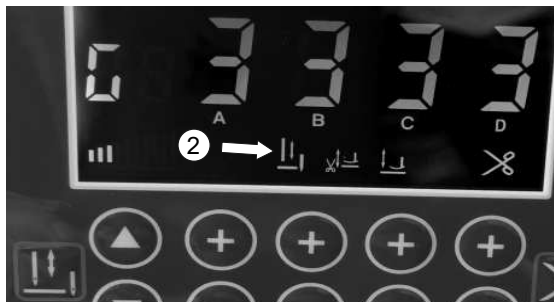

[Fig. 2]

- ▶ Make sure the stop pin is enabled.
- ▶ 确认上停针位功能开启。
- ▶ Whether or not the position of arrow 2 is displayed, shown as open.
- ▶ 2号箭头位置是否显示，显示为开启状态。

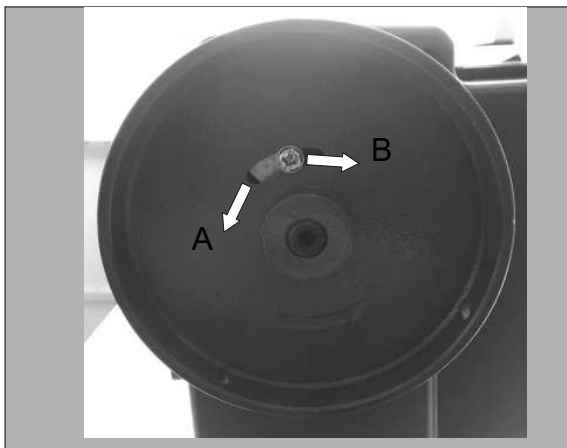

[Fig. 3]

- ▶ When it is moved in the direction of Ⓐ, the stop timing is advanced.
- ▶ When it is moved in the Ⓑ direction, the stop timing is delayed.
- ▶ Ⓐ方向移动，停止时机会变快，Ⓑ方向移动停止时机会变慢

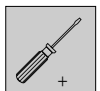

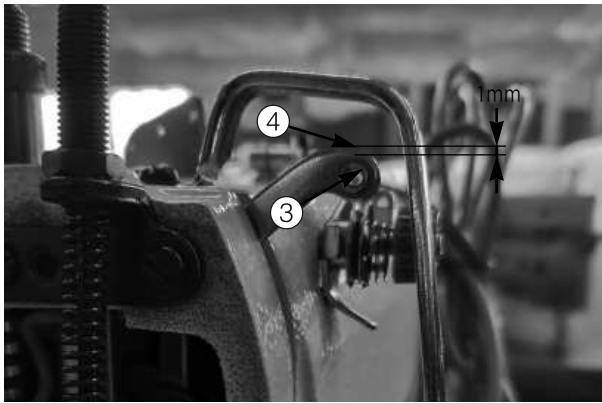

[Fig. 4]

- ▶ The highest stop position ③ of the needle bar should be 1mm below than the highest point④ of the thread take-up lever.
- ▶ 针杆上停止位置③应停在离挑线器最高点④不到1mm位置。

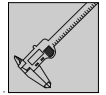

3-2

Replacement of the Mes and the Setting / 刀片更换以及安装

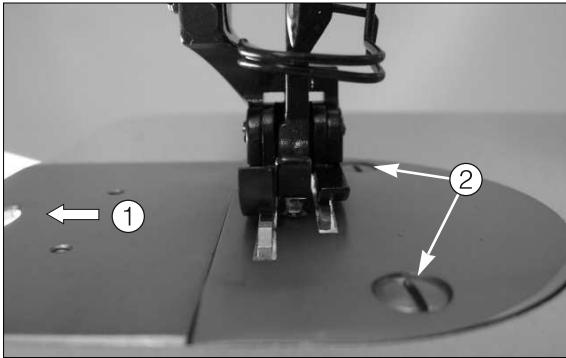

[Fig. 1]

- ▶ Press the slide① in the direction of the arrow and disassemble it.
- ▶ 箭头方向推挡板①，然后分离。

- ▶ Loosen the screw② and disassemble the needle plate.
- ▶ 松开固定螺丝②，分离针板。

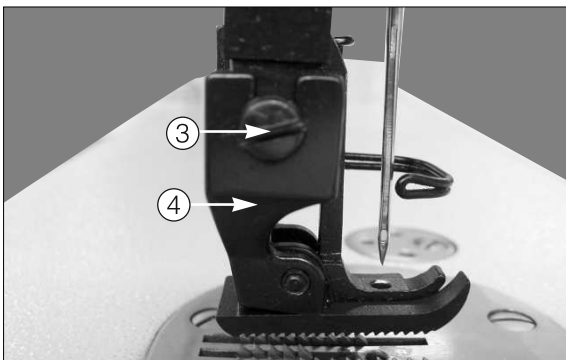
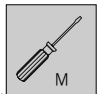

[Fig. 2]

- ▶ Loosen the screw ③ of the presser foot and disassemble the presser foot ④.
- ▶ 松开压脚固定螺丝③，分离压脚④。

- ▶ 松开压脚固定螺丝③，分离压脚④。

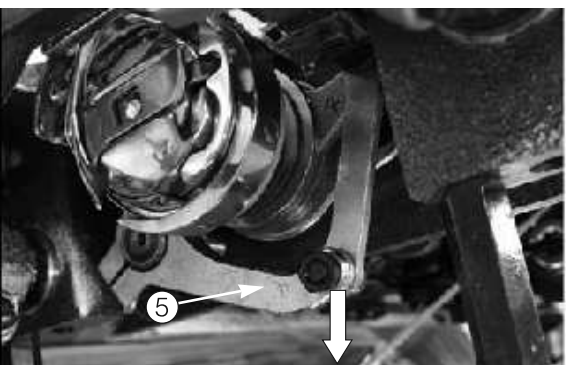
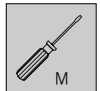

[Fig. 3]

- ▶ Press the thread trimming lever⑤ in the direction of the arrow.
- ▶ 箭头方向推剪线杆⑤。

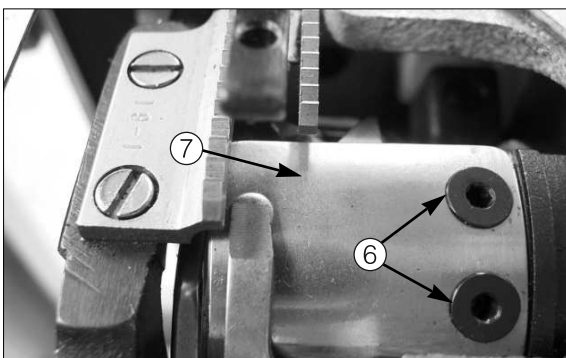

[Fig. 4]

- ▶ Press the thread trimming lever. When the screw ⑥ for the moving mes is projected in the direction of the needle plate, loosen the screw⑥ for the moving mes and replace it ⑦.
- ▶ 推剪线杆，针板方向突出动刀片固定螺丝⑥，松开动刀片固定螺丝⑥，然后更换动刀片⑦。

- ▶ 推剪线杆，针板方向突出动刀片固定螺丝⑥，松开动刀片固定螺丝⑥，然后更换动刀片⑦。

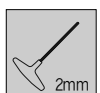

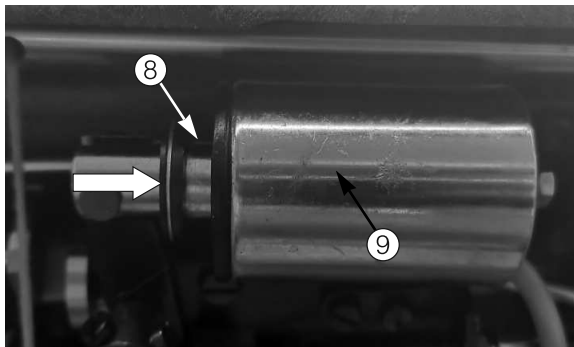

[Fig. 5]

- ▶ When the thread take-up lever is at the lowest point, push the thread trimming solenoid con^⑧ into the direction of the housing ^⑨. Slowly turn the pulley and check the overlapped portion of the moving mes and the fixed mes.
- ▶ 套管方向^⑨推在挑线器最低点时的剪线电磁阀销^⑧，手动旋转手轮，挑线器从最低点提升1mm时，确认动刀片是否开始运动。

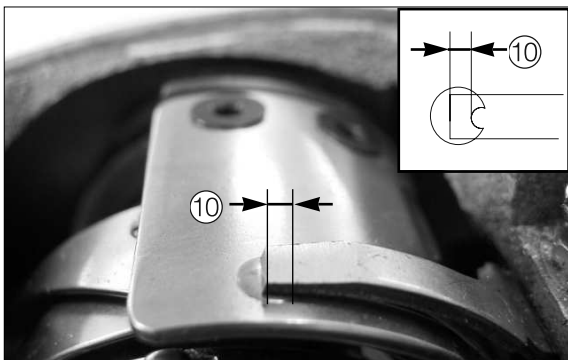

[Fig. 6]

- ▶ The overlapped part^⑩ of the moving mes and the fixed mes should be 2mm wide when measured from the cutting part of the moving mes.
- ▶ 调整动刀片和静刀片交叉量^⑩，使之在动刀片切断部位开始交叉2mm。

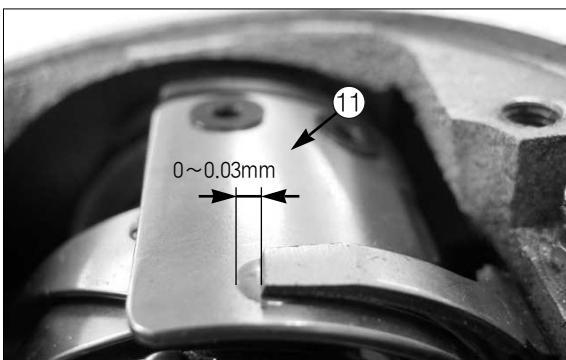
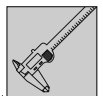

[Fig. 7]

- ▶ When the moving mes^⑪ starts motion, and the blunt end of the moving mes is 0~0.3mm distant from the end of the fixed mes, the moving mes^⑪ should return to its original position.
- ▶ 动刀片^⑪开始运动，直到动刀片钝部末端与静刀片末端间距成为0~0.3mm时，动刀片^⑪必须复位。

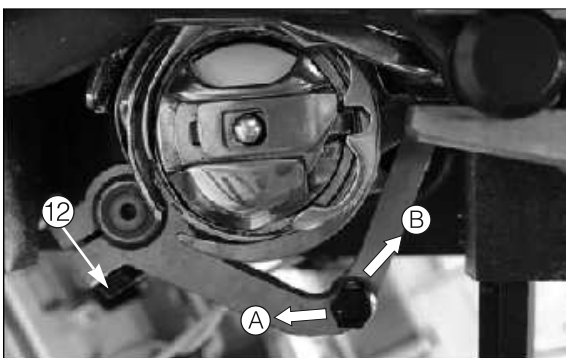
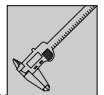

[Fig. 8]

- ▶ The overlapped part of the moving mes and the fixed mes can be adjusted by loosening the fixing screw ^⑫ for the trimming lever and moving it either in the [Ⓐ] or [Ⓑ] direction and then tightly tighten the adjusting screw.
- ▶ 调整动刀片和静刀片交叉量时，解开剪线杆固定螺丝^⑫，[Ⓐ]或[Ⓑ]方向调整后，拧紧调整螺丝。

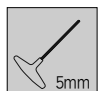

03 ● Thread Trimming Time ● 切线时机

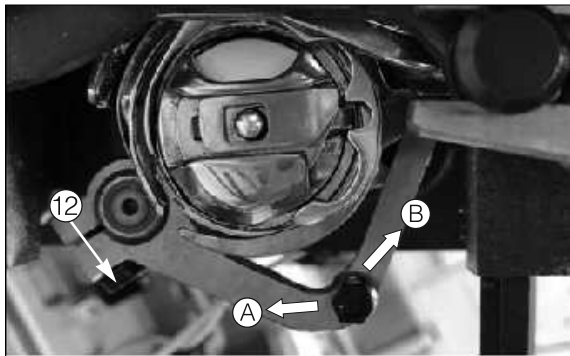

[Fig. 9]

- ▶ Ⓐ direction : The overlapped part gets bigger,
- ▶ Ⓑ direction : The overlapped park gets smaller.
- ▶ Ⓐ方向：交叉量会增加。 Ⓑ方向：交叉量会减少。

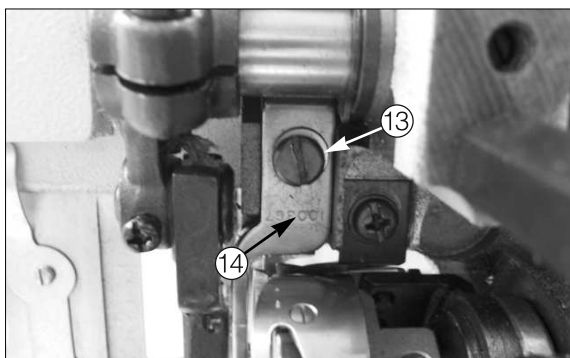

[Fig. 10]

- ▶ Loosen the hook holder screw¹³ and disassemble the hook holder¹⁴.
- ▶ 解开旋梭把螺丝¹³，分离旋梭把¹⁴。

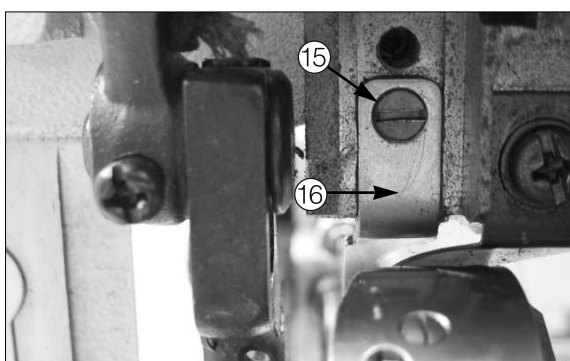

[Fig. 11]

- ▶ Loosen the screw ¹⁵ for the fixing mes¹⁶ and replace it.
- ▶ 解开静刀片固定螺丝¹⁵，更换静刀片¹⁶。

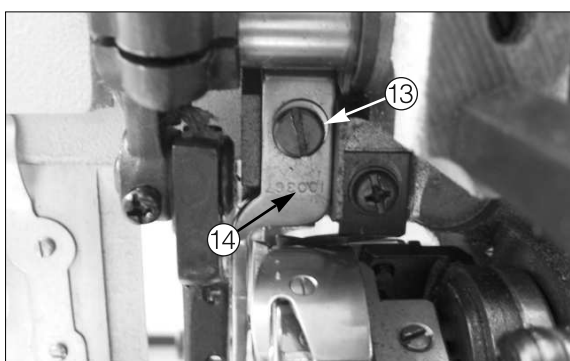

[Fig. 12]

- ▶ Insert the hook holder¹⁴ and tighten the hook holder screw¹³.
- ▶ 插入旋梭把¹⁴，拧紧旋梭把螺丝¹³。



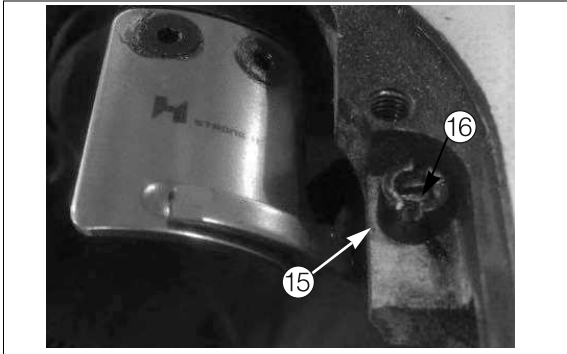

[Fig. 13]

- ▶ Loosen the nut⑮. Turn the tension adjusting screw⑯ to adjust the tension and then tighten the nut.
- ▶ 松开螺母⑮，转动张力调整螺丝⑯，调整张力后，拧紧螺母。

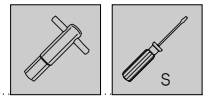

[Fig. 14]

- ▶ Use the two three-string nylon strands to conduct thread trimming test, and check whether the mes is properly returned to its original position.
- ▶ 测试2条3聚合尼龙绳,剪线后确认是否顺利复位。

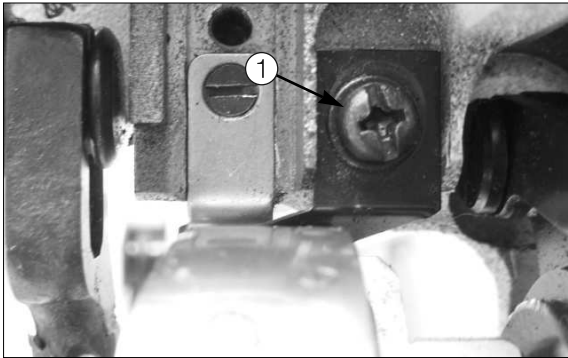

[Fig. 1]

- ▶ Loosen the fixing screw① for the thread retainer.
- ▶ 松开线挡板固定螺丝①。

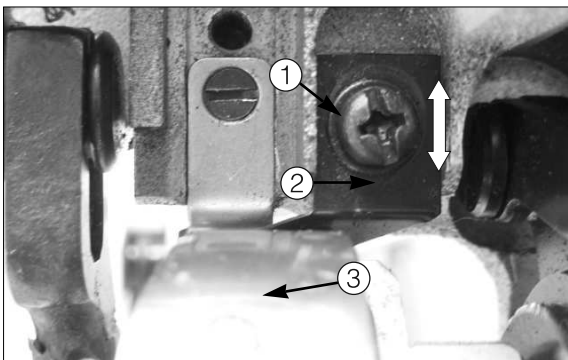
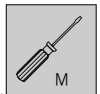

[Fig. 2]

- ▶ Move the thread retainer② up and down to make sure that the moving mes④ and the hook ③ don't interfere with each other and then tightly tighten the fixing screw①.
- ▶ 上下移动线挡板②，调整动刀片④与旋梭③，使之没有干涉，然后拧紧固定螺丝①。

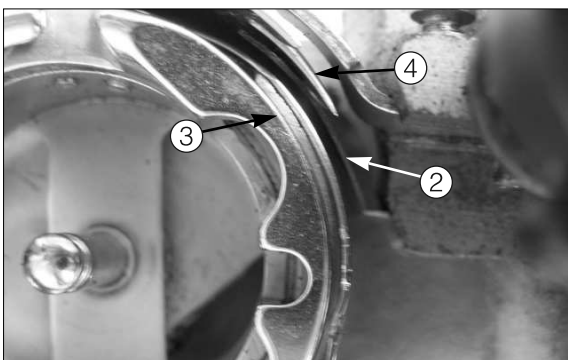
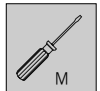

[Fig. 3]

- ▶ The thread retainer② should not interfere with the hook③. While the thread is trimmed, it should be located between the moving mes④ and the hook without interrupting anything.
- ▶ 缝纫中线挡板②与旋梭③间不能产生干涉，切线中动刀片和旋梭④间应没有干涉。

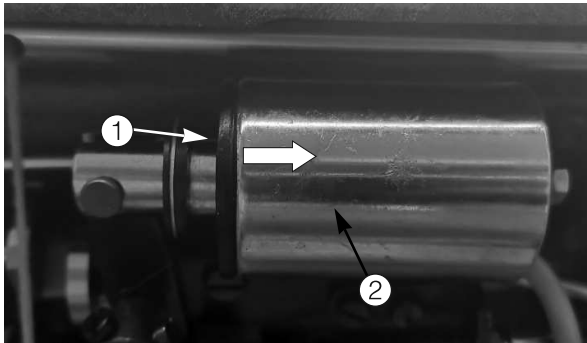

[Fig. 1]

- ▶ When the thread take-up lever is at the lowest point, push the thread trimming solenoid cam ① in the housing ② direction. Manually turn the pulley and check whether the moving mes starts moving when the thread take-up lever is 1mm above the lowest point.
- ▶ 套管方向 ② 手推在挑线器最低点时的剪线电磁阀销 ①，手动旋转手轮，挑线器从最低点提升 1mm 时，确认动刀片是否开始运动。

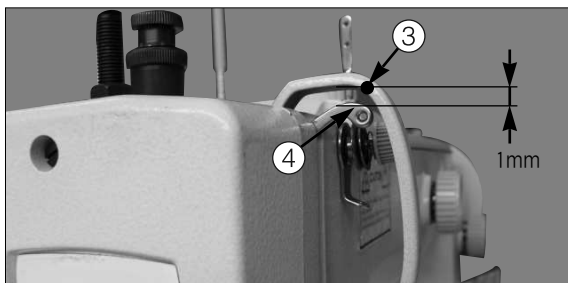

[Fig. 2]

- ▶ Before the thread take-up lever ④ reaches 1mm below the highest stop position ③, the moving mes should return to its original position.
- ▶ 挑线器 ④ 离上停止点 ③ 1mm 之前，动刀片不能复位。

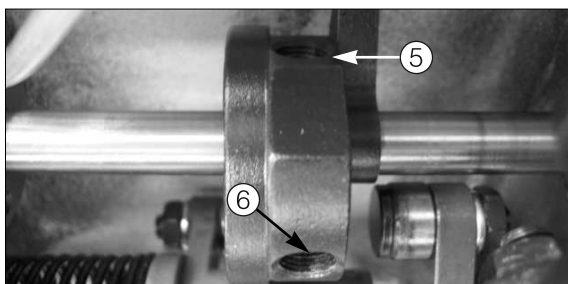
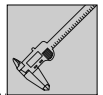

[Fig. 3]

- ▶ Loosen the screws ⑤ ⑥ of the thread cam.
- ▶ 松开剪线凸轮固定螺丝 ⑤ ⑥。

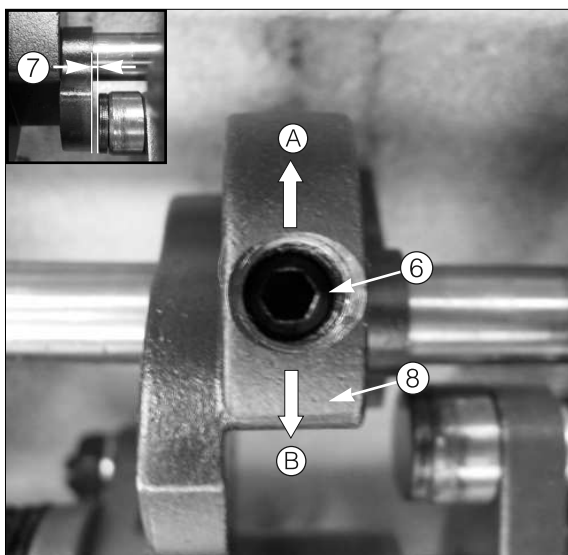

[Fig. 4]

- ▶ When the distance ⑦ between the thread trimming cam and the end of the roller hinge screw is 0.5~1mm and the thread take-up is at the lowest point, tighten the screw ⑥ of the thread trimming cam at the center of the lower shaft.
- ▶ 调整剪线凸轮与滚轮螺丝，使间距 ⑦ 保持 0.5~1mm，然后把挑线器最低点剪线凸轮 ⑥ 螺丝拧紧在下轴中央。
- ▶ Make the setting according to 1).
When the thread trimming cam ⑧ is moved in the ① direction, the motion timing of the moving mes is advanced. When it is moved in the ② direction, the motion timing is delayed.
- ▶ 根据 1) 事项进行安装。
① 方向转动剪线凸轮 ⑧，动刀片运动时机会变快，② 方向转动，动刀片运动时机会变慢。

04

BAD SEWING

缝纫不良

4-1

Hook Time / 旋梭时机

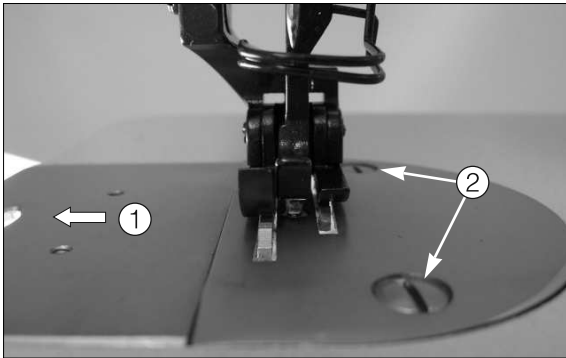

[Fig. 1]

- ▶ Disassemble the slide plate① by pushing it in the direction of the arrow.
- ▶ 箭头方向推挡板①，然后分离。

- ▶ Loosen the screw② for the needle plate and disassemble the needle plate.
- ▶ 松开针板固定螺丝②，分离针板。

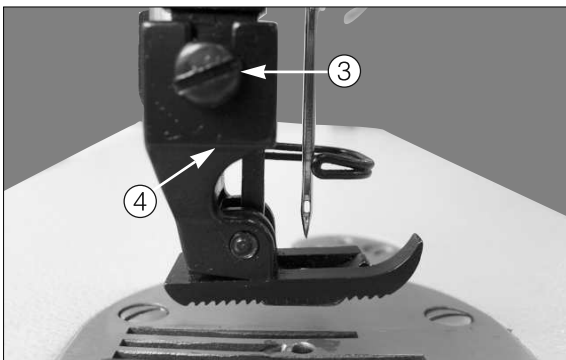

[Fig. 2]

- ▶ Loosen the screw③ for the presser foot and disassemble the presser foot④.
- ▶ 松开压脚固定螺丝③，拆卸压脚④。

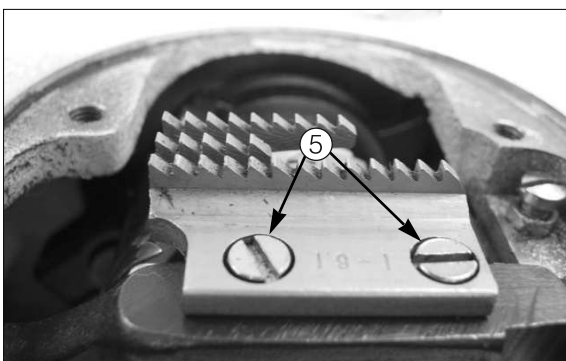

[Fig. 3]

- ▶ Loosen the screw⑤ and disassemble the feed dog.
- ▶ 解开送布牙固定螺丝⑤，分离送布牙。



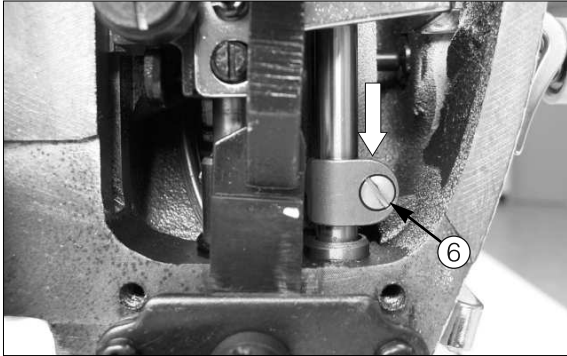

[Fig. 4]

- ▶ Manually turn the pulley to locate the needle bar at the lowest point. Loosen the screw⑥ of the needle bar.
- ▶ 手动转动手轮，针杆调到最低点，然后松开针杆固定螺丝⑥。

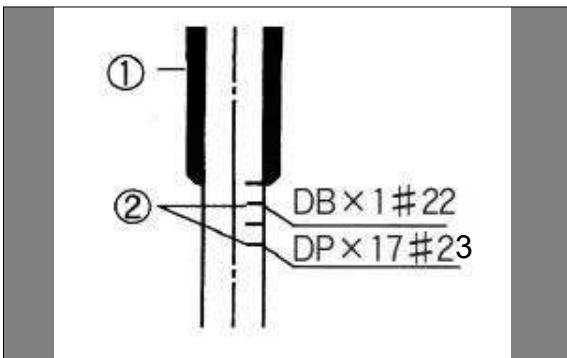
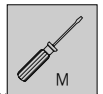

[Fig. 5]

- ▶ Move the needle bar② up and down, When the marking scale is moved to coincide with the lower edge of the shaft cover, DP × 17 is aligned with the first scale line, and DB × 1 is aligned with the third scale line to keep it consistent.
- ▶ 上下移动针杆②，记号刻度线移至和轴套①下缘一致时，DP×17时对准第一刻度线，使用DB×1时对准第三刻度线，使之保持一致

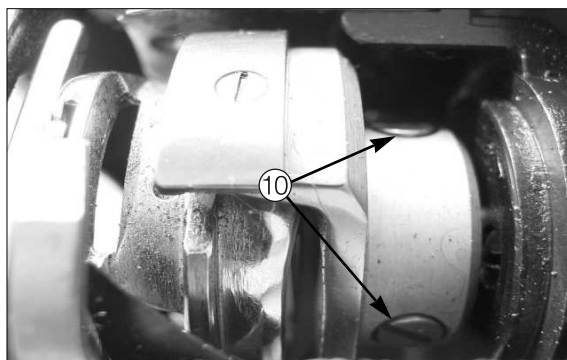

[Fig. 7]

- ▶ Loosen the screw⑩(2EA) for the hook.
- ▶ 松开旋梭固定螺丝⑩(2EA)。

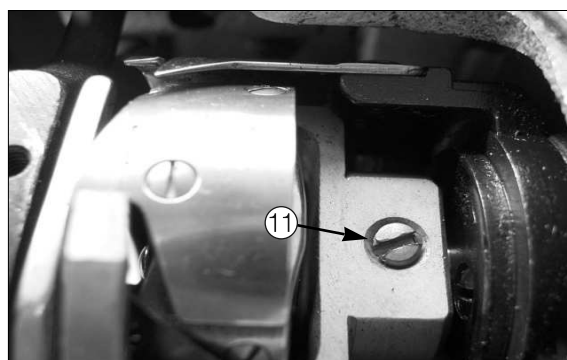
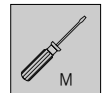

[Fig. 8]

- ▶ Loosen the auxiliary screw⑪.
- ▶ 解开辅助螺丝⑪。

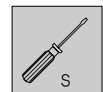

04 ● Bad Sewing ● 缝纫不良

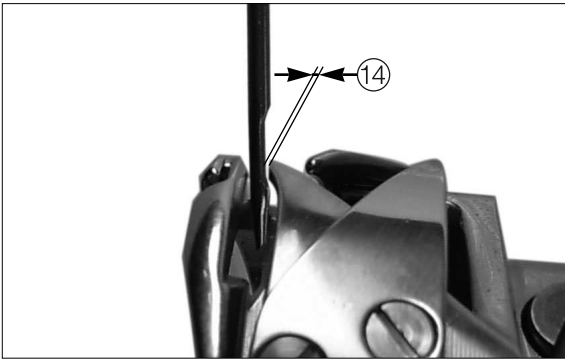

[Fig. 10]

- ▶ Set the distance ⑭ between the needle and the hook point at 0.05~0.1mm.
- ▶ 调整针与旋梭尖, 使间距⑭为0.05~0.1mm。



[Fig. 11]

- ▶ Tightly tighten the screw ⑩(2EA) for the hook and auxiliary screw ①.
- ▶ 拧紧旋梭固定螺丝⑩(2EA)和辅助螺丝①。

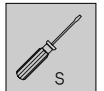
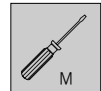



[Fig. 1]

- ▶ The upper thread is placed following the order below: Place the thread take-up lever at the highest point and the thread guide with three holes → Sub upper thread tension control device → Thread tension control device → Thread guide plate → Arm thread guide → Thread take up lever → Thread guide for the face plate → Upper thread oil felt case → Needle bar thread guide → Needle.
- ▶ 挑线器放在最高点，以微孔挂线器 → 辅助线调整装置 → 主线调整装置 → 挂线板 → 臂挂线器 → 挑线器 → 面板挂线器 → 面线加油毛粘把 → 针杆护线器 → 针顺序挂线。



[Fig. 2]

- ▶ Make the thread① left at 40mm after passing the needle and cut the thread longer than 40mm.
- ▶ 穿线量①调为40mm，然后切断线余量。



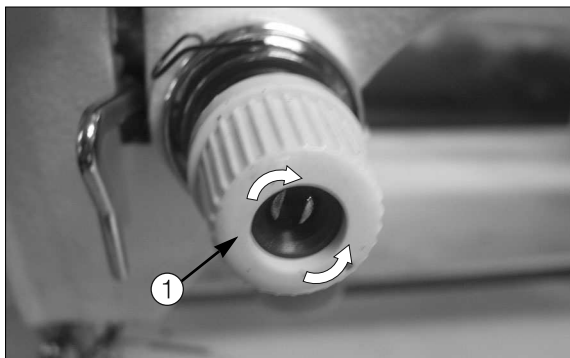

[Fig. 1]

- ▶ When the adjusting nut① of the thread tension control device is turned clockwise, the upper thread tension gets stronger. When it is turned counter-clockwise, the upper thread tension gets weaker.
- ▶ 顺时针转动主线调整装置张力调整螺母①，面线张力会增加，逆时针转动面线张力会减少。

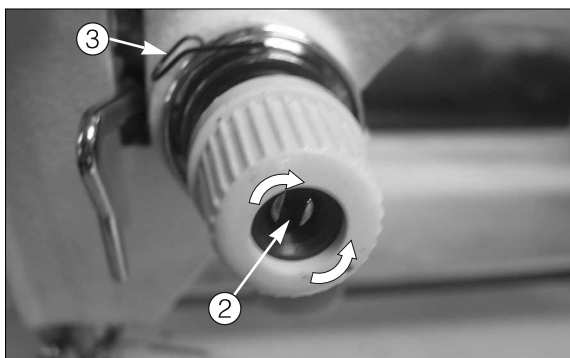

[Fig. 2]

- ▶ Insert the driver into the groove② of the thread tension control device shaft and turn it clockwise and then the tension of the thread take-up lever string③ gets stronger. When it turned counter-clockwise, the tension gets weaker.
- ▶ 扳手插入线调整装置轴前端槽②，顺时针转动挑线器弹簧③张力会增加，逆时针则减少。

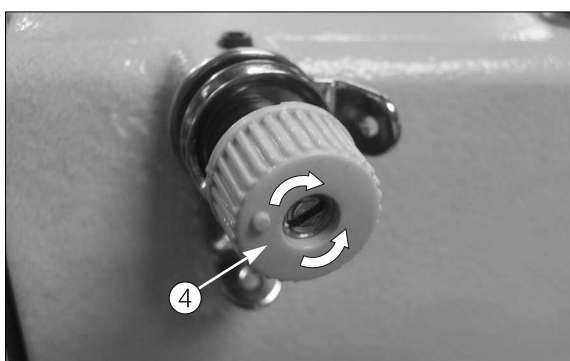

[Fig. 3]

- ▶ When the tension adjusting nut④ of the sub upper thread tension control device is turned clockwise, the remaining thread gets shorter. When it is turned counter-clockwise, the remaining thread gets longer.
- ▶ 顺时针转动辅助线调整装置张力调整螺母④，线余量会减少，逆时针转动则增加。

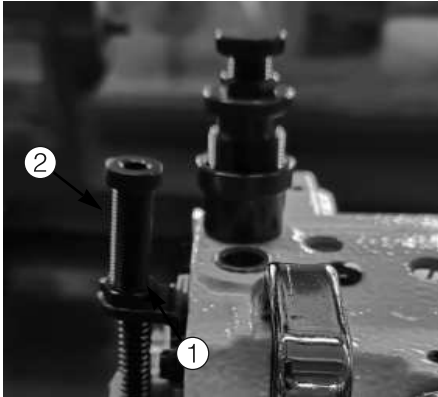

[Fig. 1]

- ▶ Loosen the nut① and turn the screw② for the presser foot to adjust the pressure of the presser foot.
- ▶ 松开螺母①后，转动主压脚压力调整螺丝②，调整主压脚压力。

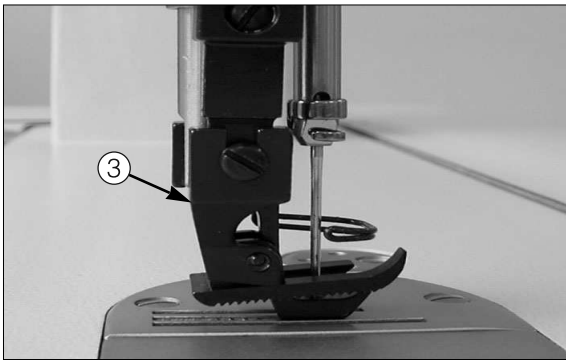

[Fig. 2]

- ▶ When the screw② is turned clockwise, the pressure of the main presser foot③ gets stronger. When it is turned counter-clockwise, the pressure gets weaker.
- ▶ 顺时针转动压力调整螺丝②，主压脚③压力会增加，相反则减少。

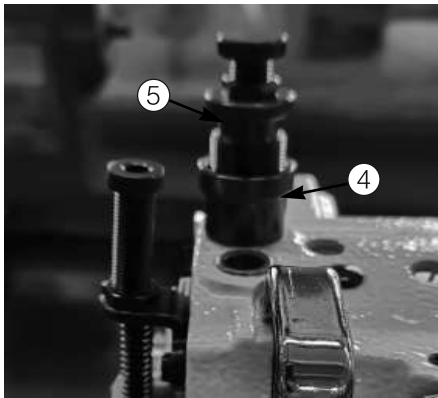

[Fig. 3]

- ▶ Loosen the nut④ for the pressure adjusting screw and turn the pressure adjusting screw⑤ to adjust the pressure of the sub presser foot.
- ▶ 松开压脚调整螺丝固定螺丝④，转动压力调整螺丝⑤，调整压脚压力。



[Fig. 4]

- ▶ When the pressure adjusting screw⑤ is turned clockwise, the pressure of the sub presser foot⑦ gets stronger. When it is turned counter-clockwise, the pressure gets weaker.
- ▶ 顺时针压力调整螺丝⑤，辅助压脚⑦压力会增加，逆时针转动，压力则减少。
- ▶ Use the sub pressure adjusting screw⑥ when delicately adjusting the pressure of the sub presser foot⑦.
- ▶ 利用辅助压力调整螺丝⑥，细微调整辅助压脚⑦压力。

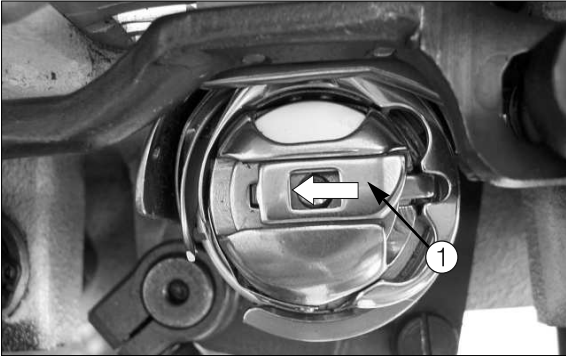

[Fig. 1]

- ▶ Push the bobbin case removal lever① in the arrow direction and disassemble the bobbin case.
- ▶ 箭头方向往后放梭壳安装杆①，拆卸梭壳。

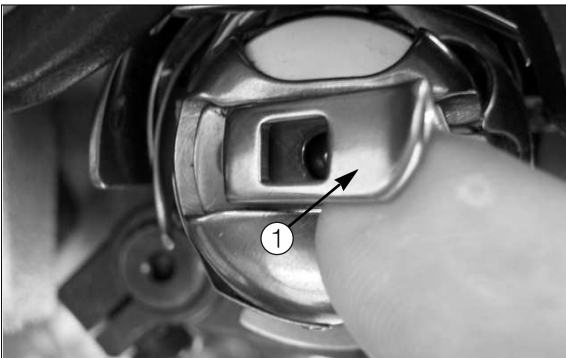

[Fig. 2]

- ▶ When removing or placing back the bobbin case, make sure that it doesn't negatively affect the lever①.
- ▶ 安装 拆卸梭壳时，不能往杆①施加太多压力。

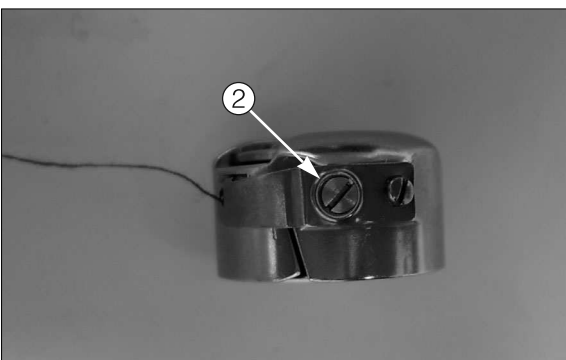

[Fig. 3]

- ▶ Turn the lower thread tension adjusting screw② clockwise, and the lower thread tension gets stronger. When it is turned counter-clockwise, the lower thread tension gets weaker.
- ▶ 顺时针转动底线张力调整张调整螺丝②，底线张力会增加；逆时针转动，底线张力则减少。

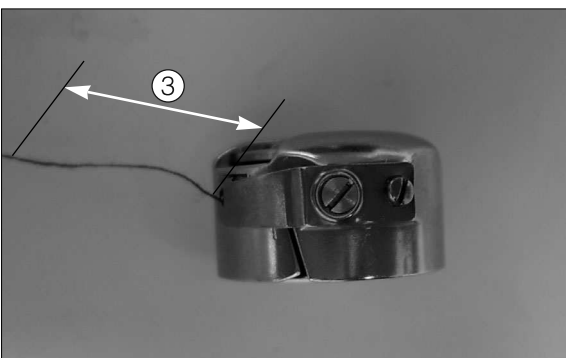

[Fig. 4]

- ▶ Normally, about 30~40mm long thread③ is projected from the bobbin case when the bobbin case is inserted. Make sure the thread doesn't enter into the hook.
- ▶ 线插入梭壳时，梭壳外露出的线③标准量为30~40mm，另外线不能键入旋梭内。

05

NOISE 噪音

5-1

Upper Shaft Collar Clearance / 上轴轴环间隔



[Fig. 1]

- ▶ Hold the pulley① by hand and slightly shake it in the direction of the arrows to check where there is clearance in the upper shaft.
- ▶ 用手畜手轮①，箭头方向轻轻晃动，确认上轴间隔。

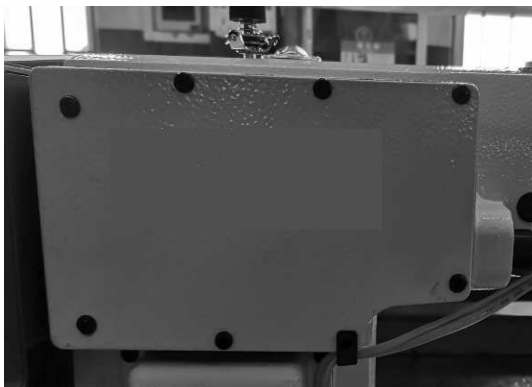

[Fig. 2]

- ▶ If there is clearance in the upper shaft, disassemble the top cover ②.
- ▶ 确认上轴间隔后，拆卸面盖②。

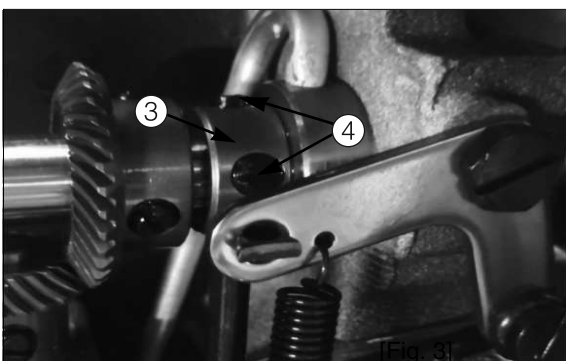
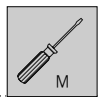

[Fig. 3]

- ▶ Loosen the screw④ of the upper shaft collar③ by turning it full circle.
- ▶ 松1圈上轴轴环③的固定螺丝④。

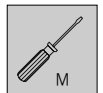

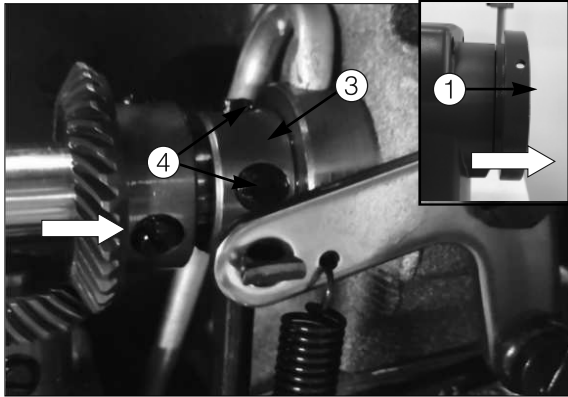

[Fig. 4]

▶ Pull the pulley① in the direction of the arrow and put the upper shaft collar③ closely to the bushing and then tighten the screw④ of the upper shaft collar.

▶ 箭头方向拉滑轮①，让上轴轴环③紧贴套管后，拧紧上轴轴环固定螺丝④。

▶ Tighten the first screw from the revolving direction of the upper shaft and then the second screw.

▶ 拧紧上轴旋转方向1号螺丝后，拧紧2号螺丝。

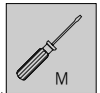

[Fig. 5]

▶ Turn the pulley① and check whether there is clearance or jam.

▶ 转动手轮①，确认间隔以及是否负荷。

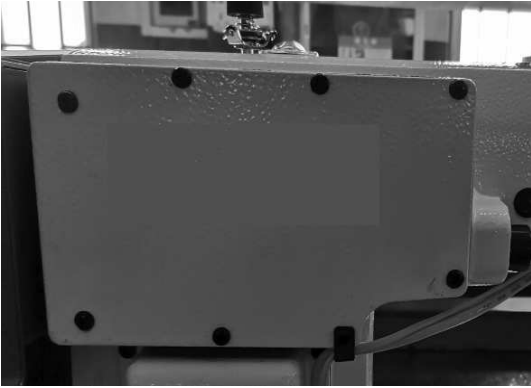

[Fig. 1]

- ▶ Disassemble the rear cover①.
- ▶ 分离后面盖①。

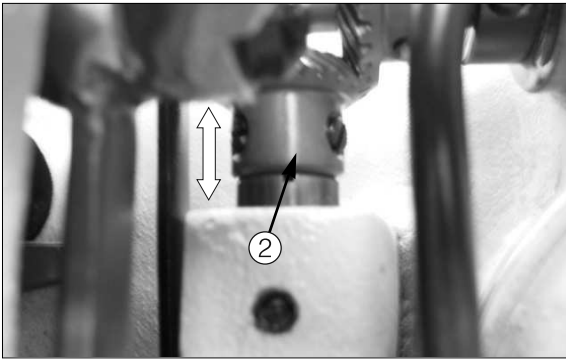

[Fig. 2]

- ▶ Slightly move the upright shaft upper gear② up and down, and check the clearance of the upright shaft.
- ▶ 上下轻轻移动立轴齿轮②，确认立轴间隔。

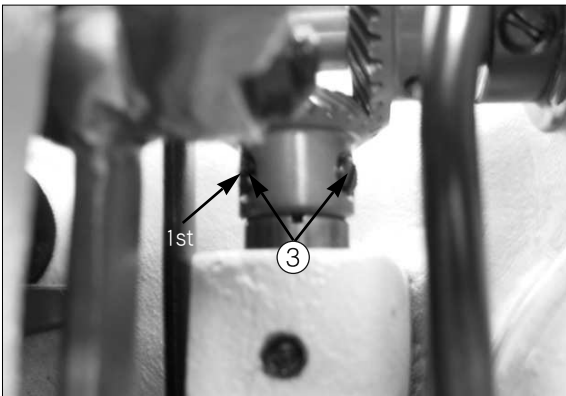

[Fig. 3]

- ▶ If it is confirmed that there is clearance in the upright shaft, loosen the screw③ of the upright shaft upper gear by turning it full circle.
- ▶ 确认立轴间隔后，松1圈立轴上齿轮螺丝③。

- ▶ Make sure that the first screw which is fixed to the cutting part of the standing shaft is not turned.
- ▶ 注意不能转动立轴面部固定的1号螺丝(1st)位置。

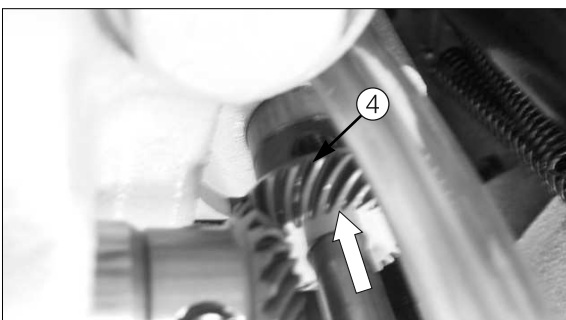
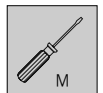

[Fig. 4]

- ▶ Lay down the bed and push up the upright shaft lower gear④.
- ▶ 横放机床，然后往上提升立轴下齿轮④。

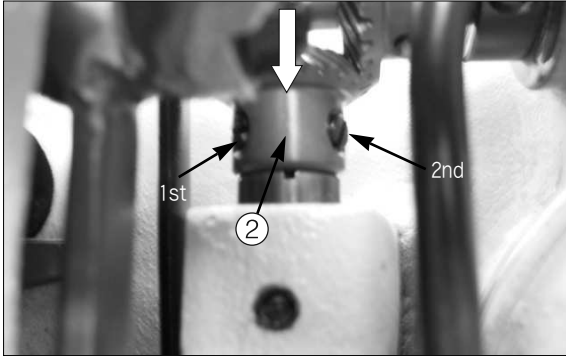

[Fig. 5]

- ▶ Place the upright shaft upper gear② close to the bushing. Tighten the first screw from the revolving direction of the upright shaft cutting part and then the second screw.
- ▶ 立轴上齿轮②紧贴套管后，首先拧紧立轴面取部旋转方向的第一个螺丝，然后拧紧第二个螺丝。



[Fig. 6]

- ▶ Manually turn the pulley⑤ and check whether there is clearance or jam.
- ▶ 手动转动手轮⑤，确认负荷以及间隔。

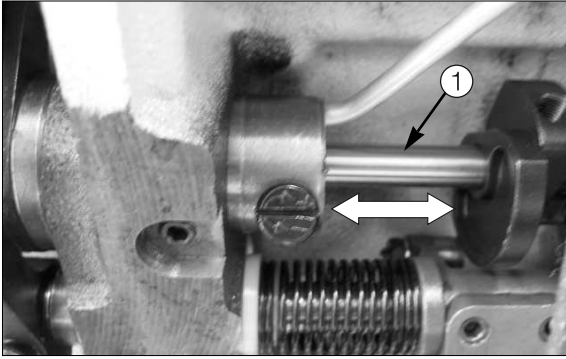

[Fig. 1]

- ▶ Hold the lower shaft① and slightly move it in the arrow direction to check the clearance.
- ▶ 握住下轴①，肩头方向轻轻晃动，确认间隔。

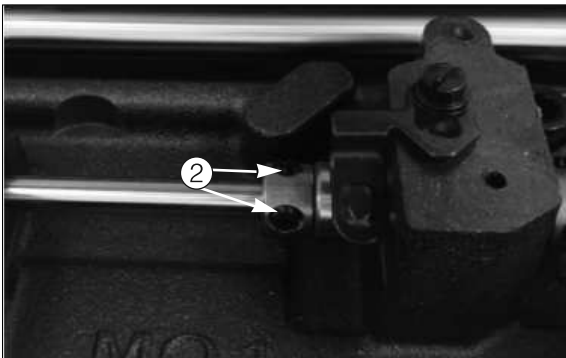

[Fig. 2]

- ▶ If there is clearance in the lower shaft, loosen the lower shaft collar screw②.
- ▶ 确认下轴间隔后，松开下轴轴环固定螺丝②。

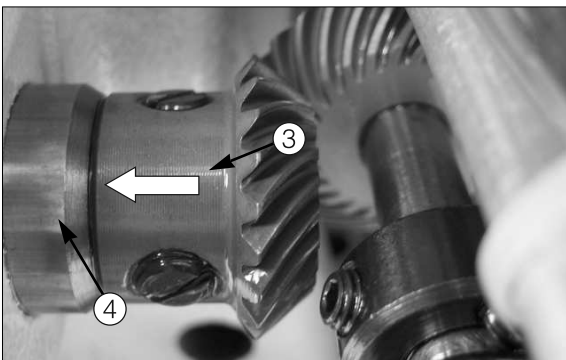
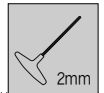

[Fig. 3]

- ▶ Place the lower shaft gear③ toward the lower shaft rear bushing ④.
- ▶ 下轴后套管方向④紧贴下轴齿轮③。

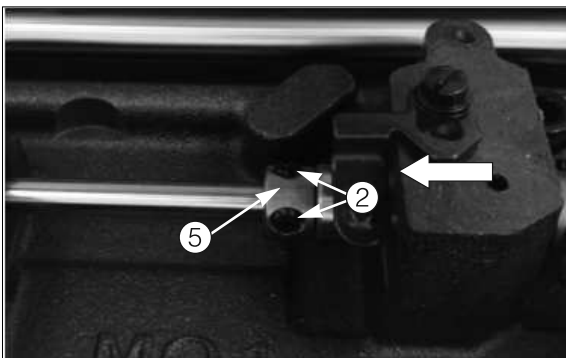

[Fig. 4]

- ▶ Place the lower shaft collar⑤ close to the rear bushing and then tighten the lower shaft collar screw②.
- ▶ 下轴后套管方向紧贴下轴齿轮⑤后，拧紧下轴轴环固定螺丝②。

- ▶ Check whether there is clearance or jam.
- ▶ 确认下轴负荷以及间隔。

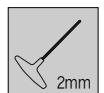

06

OIL SUPPLY 加油

6-1

Oil Supply / 加油

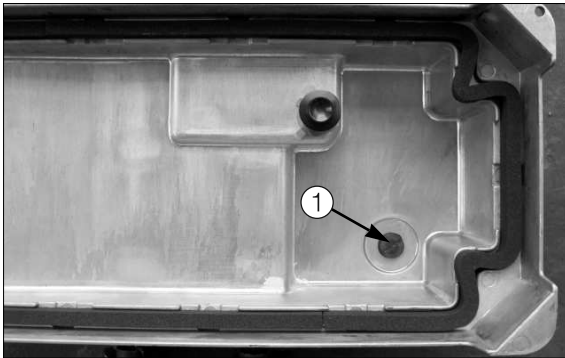

[Fig. 1]

- ▶ Loosen the screw① of the oil fan. Remove the polluted oil or foreign materials and tightly tighten the screw.
- ▶ 打开油盘橡胶盖①，清除被污染的油或异物，然后拧紧橡胶盖。

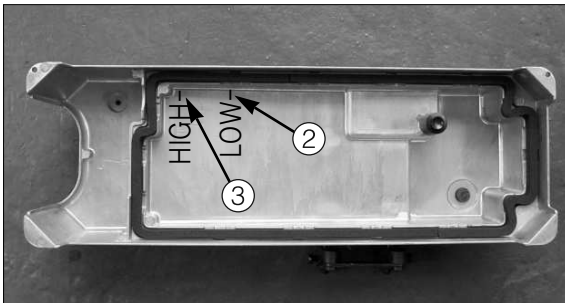

[Fig. 2]

- ▶ Fill the original SunStar oil up to the HIGH mark③.
- ▶ 加正品油，使油量达到HIGH标记③。
- ▶ If the oil volume is below the LOW mark②, it can cause machine problems.
- ▶ 如果油量少于LOW标记②，可能会发生疏盘等现象。

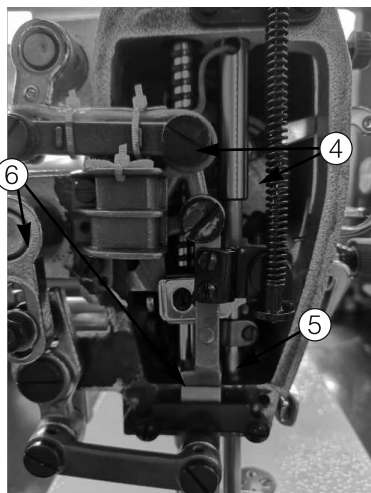
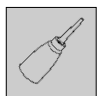

[Fig. 3]

- ▶ If the sewing machine is left unused for long time, please disassemble the face plate.
- ▶ 长时间不使用缝纫机时，请拆卸面板。
- ▶ Supply two to three drops of oil to the thread take-up lever hinge plate connection part④, the needle bar⑤ and the presser bar⑥.
- ▶ 往挑线器铰链板连接部位④，针杆⑤以及压杆⑥加2~3滴油。

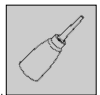

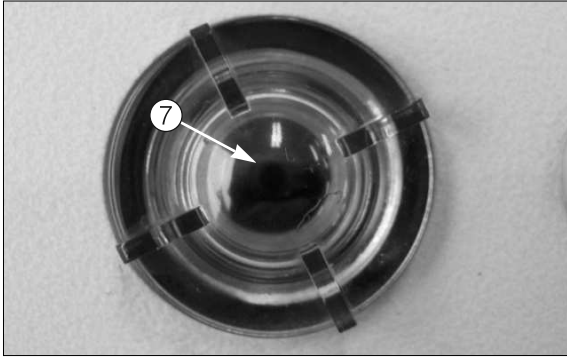

[Fig. 4]

- ▶ Make a test sewing at the speed of 2000spm for 10 minutes and check whether oil is sprayed to the oil window.
- ▶ 以2000spm速度试运行约10分钟，确认是否在油窗⑦喷油。

6-2

Adjusting the Oil Supply Volume for the Thread Take-up / 调整挑线器部位加油量



[Fig. 1]

- ▶ Disassemble the face plate.
- ▶ 拆卸面板。

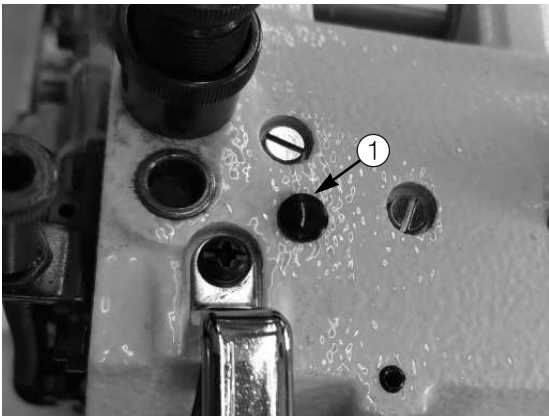

[Fig. 2]

- ▶ Add Oil at 1
- ▶ 在1处添加润滑油。



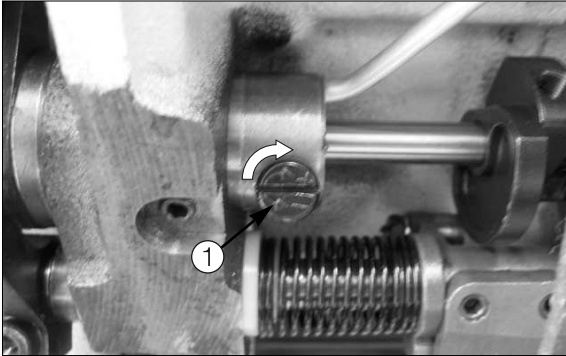

[Fig. 1]

- ▶ Lay down the arm bed toward the hinge.
- ▶ 铰链方向横放臂床。

- ▶ Turn the oil supply adjusting screw ① clockwise and the oil supply volume to the hook increases.
- ▶ 顺时针方向转动油量调整螺丝①，旋梭内加油量会增加。

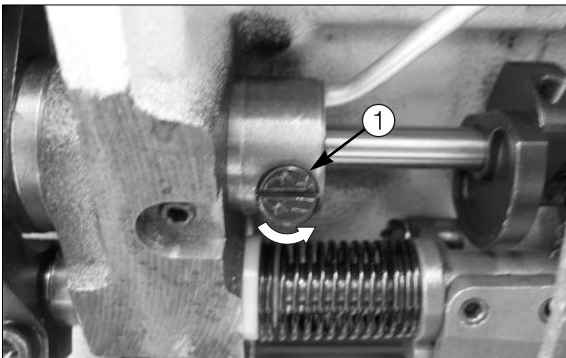
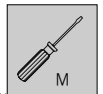

[Fig. 2]

- ▶ Turn the oil supply adjusting screw ① counter-clockwise and the oil supply volume to the hook decreases.
- ▶ 逆时针转动油量调整螺丝①，旋梭内加油量会减少。

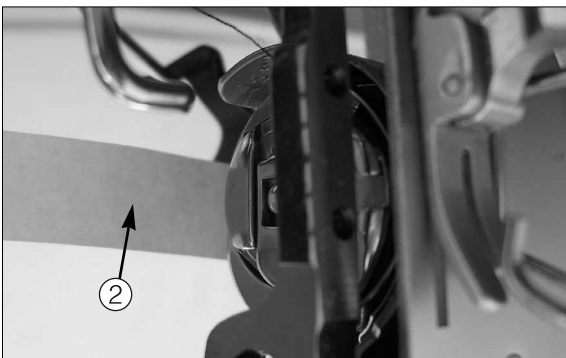
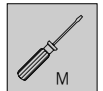

[Fig. 3]

- ▶ Place a test paper ② at 10mm away from the hook. Conduct a test sewing at the speed of 2000SPM for ten seconds and check the oil volume supplied to the hook.
- ▶ 试验用纸②放在离旋梭10mm远位置，然后以2000SPM试运行，确认旋梭加油量。

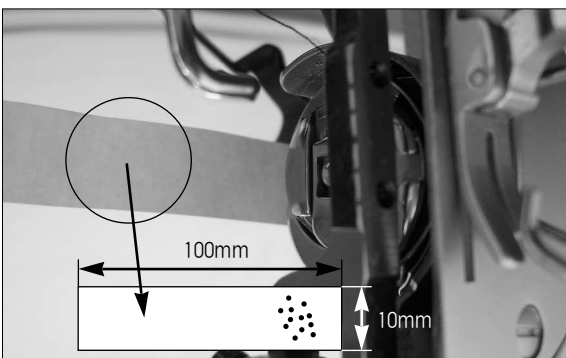

[Fig. 4]

- ▶ The standard oil supply volume is 10 oil drops on the test paper ②.
- ▶ 正常时，试验用纸②被滴约10滴油。

07

SOLENOID 电磁阀

7-1

Thread Trimming Solenoid / 剪线电磁阀

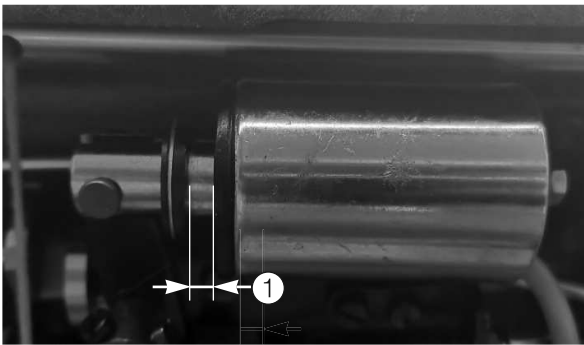

[Fig. 1]

- ▶ The motion range① of the thread trimming solenoid is 4~5mm.
- ▶ 剪线电磁阀运动量①为4~5mm。

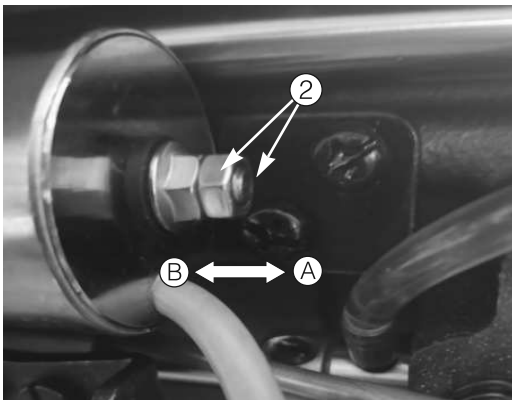
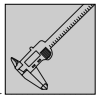

[Fig. 2]

- ▶ Loosen and turn the nut②. When the nut is moved in the ① direction, the motion range gets bigger. When it is moved in the ② direction, the motion range gets smaller.
- ▶ 松开螺母②，旋转螺母，①方向移动运动量会增加；②方向移动运动量会减少。

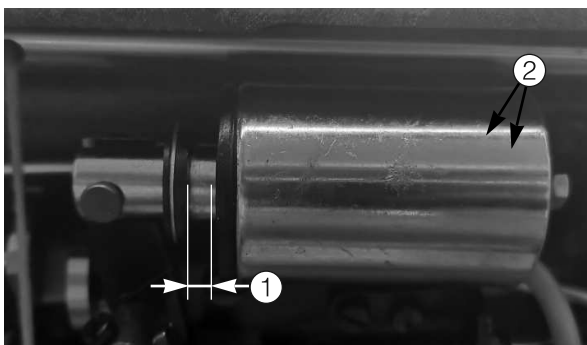
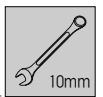

[Fig. 3]

- ▶ Set the thread trimming solenoid motion range① at 4~5mm and tighten the nut②.
- ▶ 剪线电磁阀运动量①调为4~5mm后，固定螺母②。

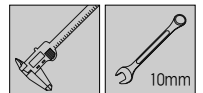

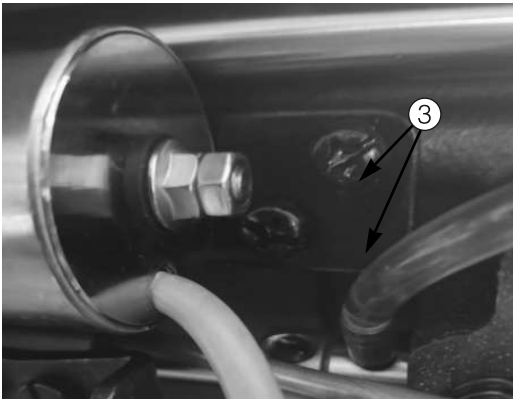

[Fig. 4]

- ▶ Loosen the screw③ for the thread trimming solenoid bracket.
- ▶ 松开剪线电磁阀支架固定螺丝③。

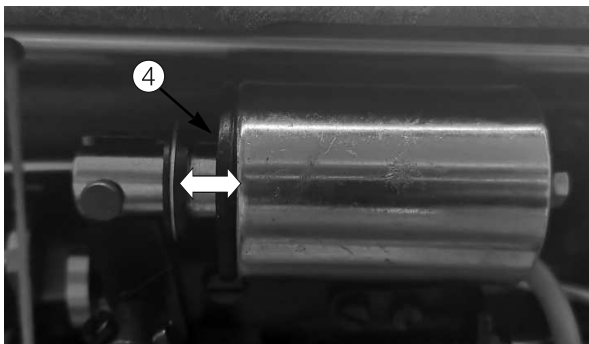
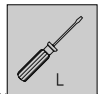

[Fig. 5]

- ▶ Manually move the thread trimming solenoid corn④ back and forth and find the place where it can operate most smoothly.
- ▶ 手动方式前后移动剪线电磁阀销④，寻找最顺利运行地点。

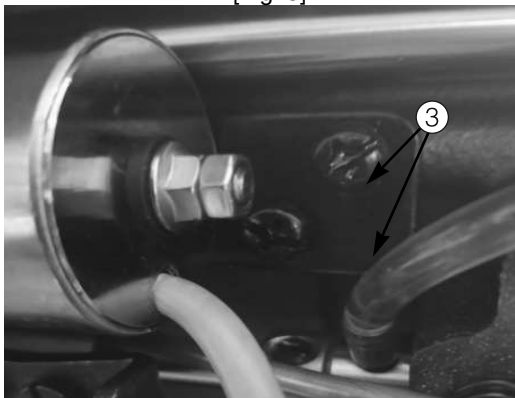

[Fig. 6]

- ▶ Tightly tighten the screw③ for the thread trimming solenoid base.
- ▶ 拧紧剪线电磁阀基座固定螺丝③。

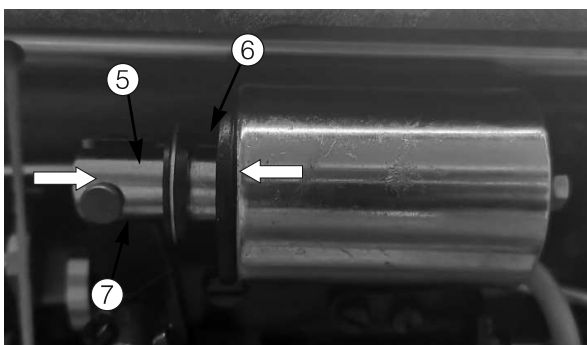
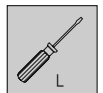

[Fig. 7]

- ▶ Loosen the screw⑤ and push the solenoid corn⑥ in the direction of the arrow. Push the solenoid pin⑦ in the direction of the solenoid and then tighten the screw⑤.
- ▶ 松开固定螺丝⑤后，箭头方向推电磁阀销⑥，电磁阀方向推电磁阀销⑦，然后拧紧固定螺丝⑤。

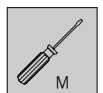

08

ADJUSTING THE FORWARD/BACKWARD STITCH LENGTH

前后进针距调整

8-1

Adjusting the Delicate Adjusting Shaft / 调整微调轴

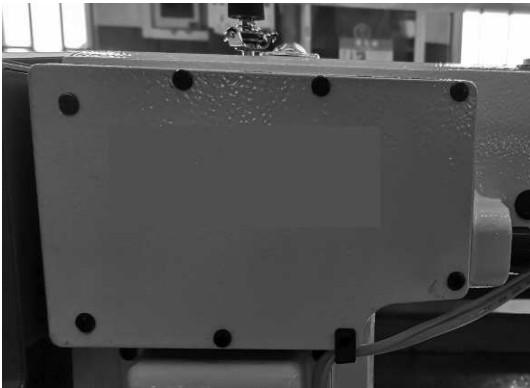

[Fig. 1]

- ▶ Loosen the screws and disassemble the bartacking solenoid cover.
- ▶ 松开固定螺丝拆卸倒缝电磁阀盖。

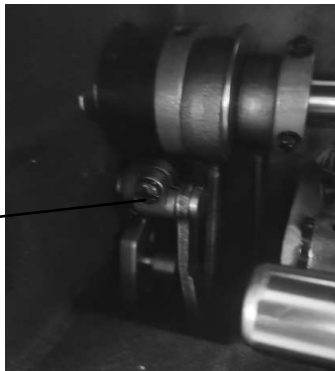

[Fig. 2]

- ▶ Loosen the screw A of feed adjusting shaft by turning it full circle.
- ▶ 松开1圈送料调整轴固定螺丝A。

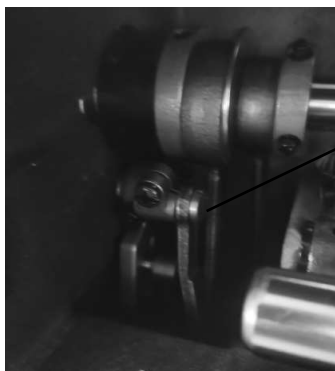
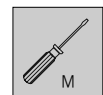

[Fig. 3]

- ▶ Adjusting eccentric adjustment pin B with a wrench up and down rotation.
- ▶ 使用扳手上下旋转调整偏心调节销B。

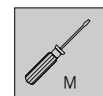

08 ● Adjusting the Forward/Backward Stitch Length ● 前后进针距调整

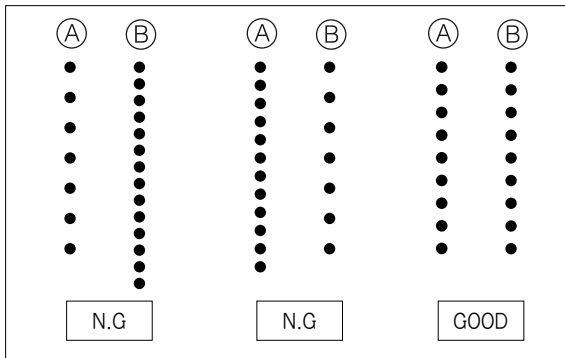

[Fig. 9]

- ▶ Place the test paper inside the presser foot and make the forward sewing ㊶ and backward sewing ㊷ to check whether the forward and backward sewing have identical stitch length.
- ▶ 试验用纸插入压脚后，低速前进㊶和后进㊷，确认前后进针距。

