

1

Stitches: 36 381
Height: 300 mm
Width: 131 mm
Thread Velvet™

1  7021
1014

2  1191
2417

3  7007
1003

4  7021
1014

5  1191
2417

6  1251
2730

7  7007
1003

8  1191
2417

9  1251
2730

10  7007
1003

Gütermann Sulky
Robison - Anton

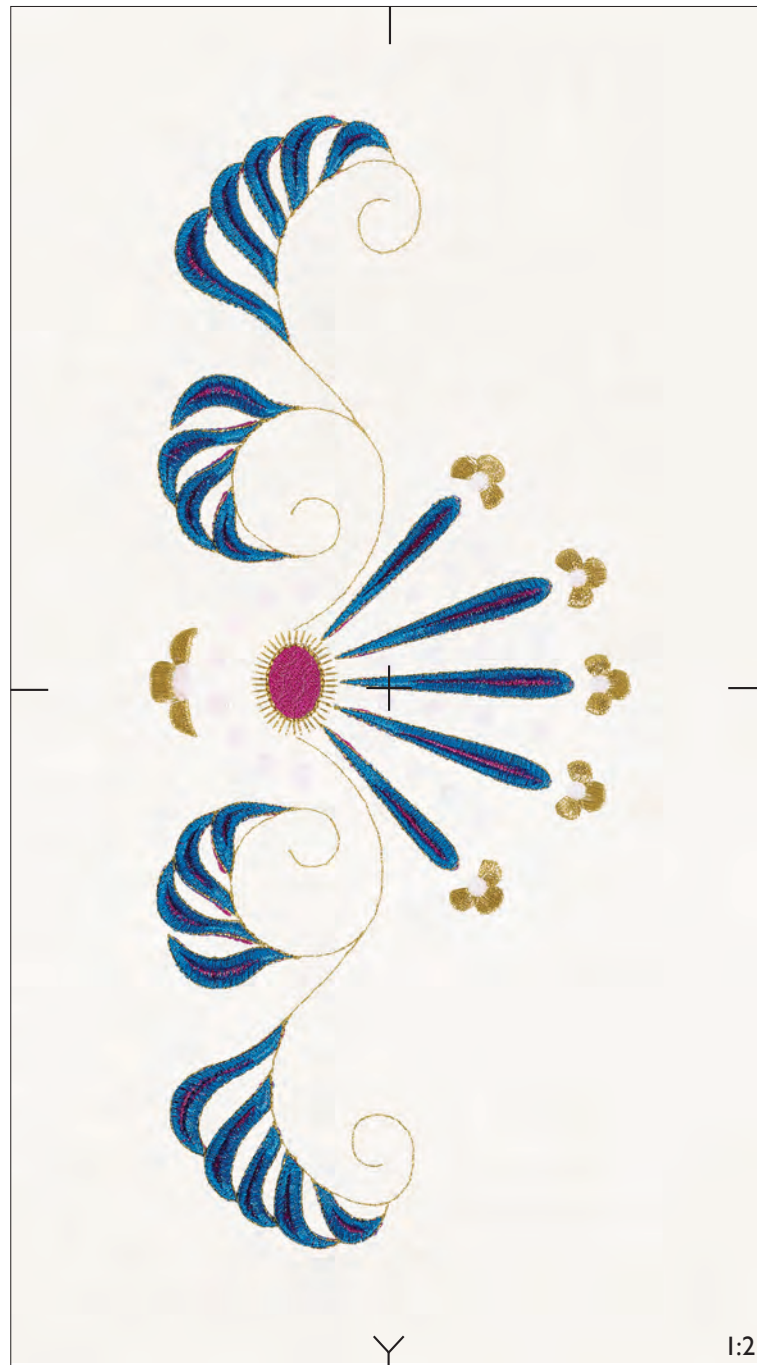



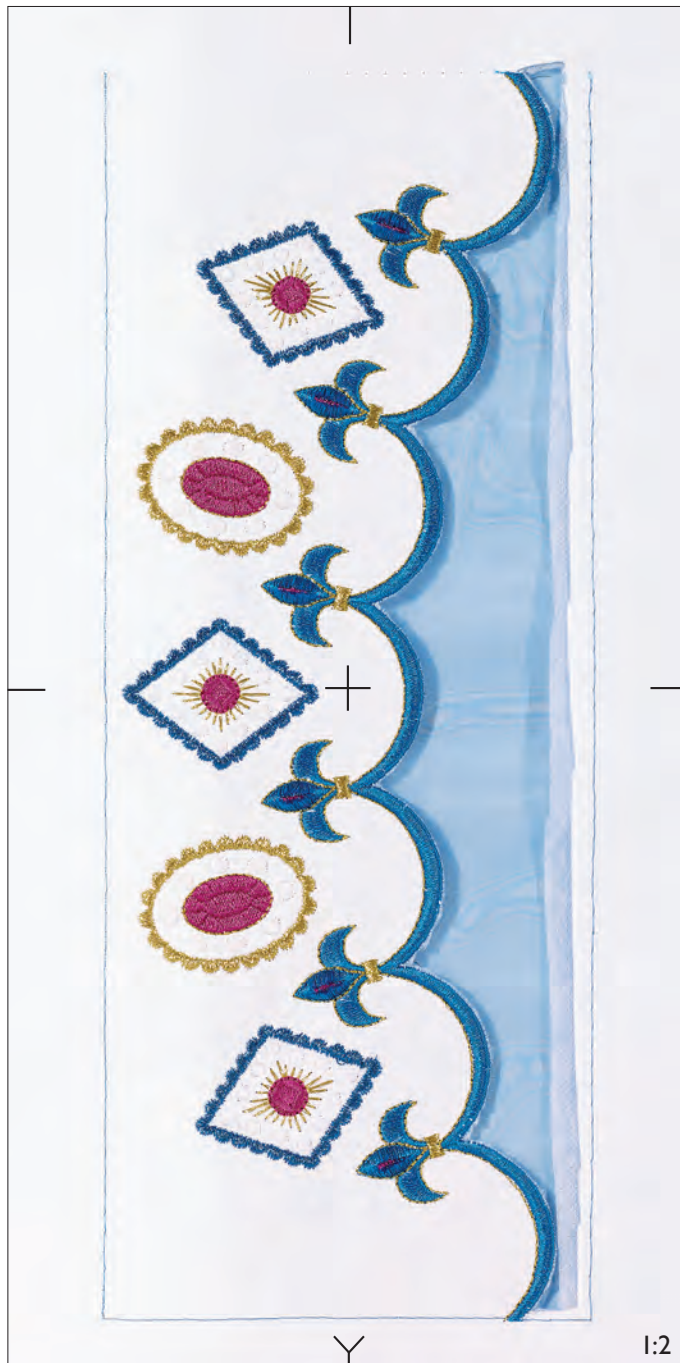















Stitches: 25 098
 Height: 330 mm
 Width: 129 mm
 Thread Velver™



Y

1:2

- 1  7007
1003
- 2  1191
2417
- 3  7021
1014
- 4  7052
1012
- 5  1191
2417
- 6  7021
1014
- 7  7007
1003
- 8  1251
2730
- 9  1191
2417
- 10  1251
2730
- 11  7007
1003
- (✂) Cut inside marked area if not using INSPIRA™ Cutwork Needles
- 12  Needle #1
- 13  Needle #2
- * Add a heavy weight water soluble stabilizer underneath the hoop
- 14  1251
2730
- 15  1251
2730
-  Trim and remove the cut fabric
- 16  1251
2730
- * If desired: cut away water soluble stabilizer along the satin edge and place second fabric underneath the hoop
- 17  7007
1003
-  Clean the Bobbin Area

Gütermann Sulky
 Robison - Anton

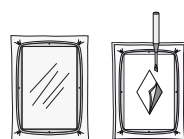

3

Stitches: 14 046
Height: 190 mm
Width: 130 mm

1  7007
1003

2  1191
2417

3  7021
1014

4  7052
1012

5  1191
2417

6  7021
1014

7  7007
1003

8  1251
2730

9  1191
2417

10  1251
2730

11  7007
1003

 Cut inside marked area
if not using INSPIRA™
Cutwork Needles

12  Needle #1

13  Needle #2

*  Add a heavy weight water
soluble stabilizer
underneath the hoop

14  1251
2730

15  1251
2730

 Trim and remove the
cut fabric

16  1251
2730

*  If desired: cut away water
soluble stabilizer along the
satin edge and place second
fabric underneath the hoop

17  7007
1003

 Clean the Bobbin Area

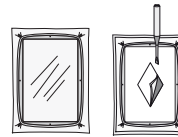
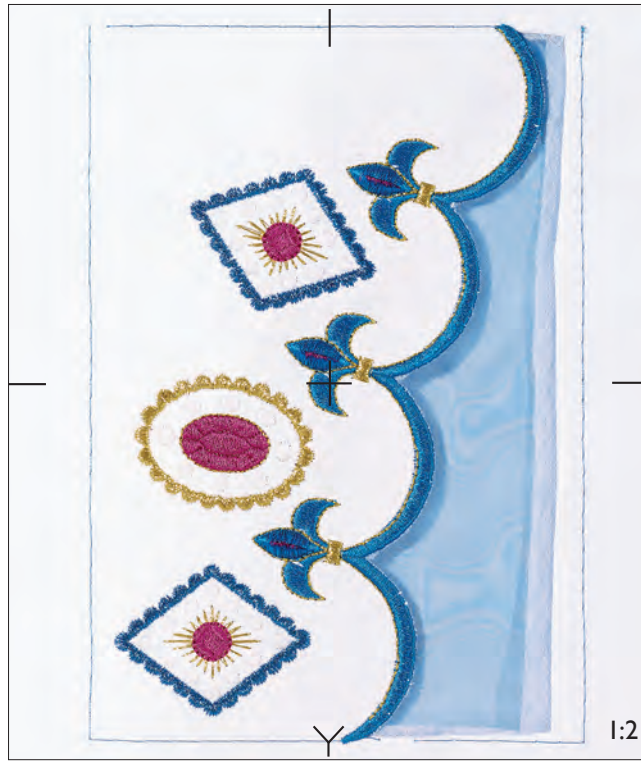

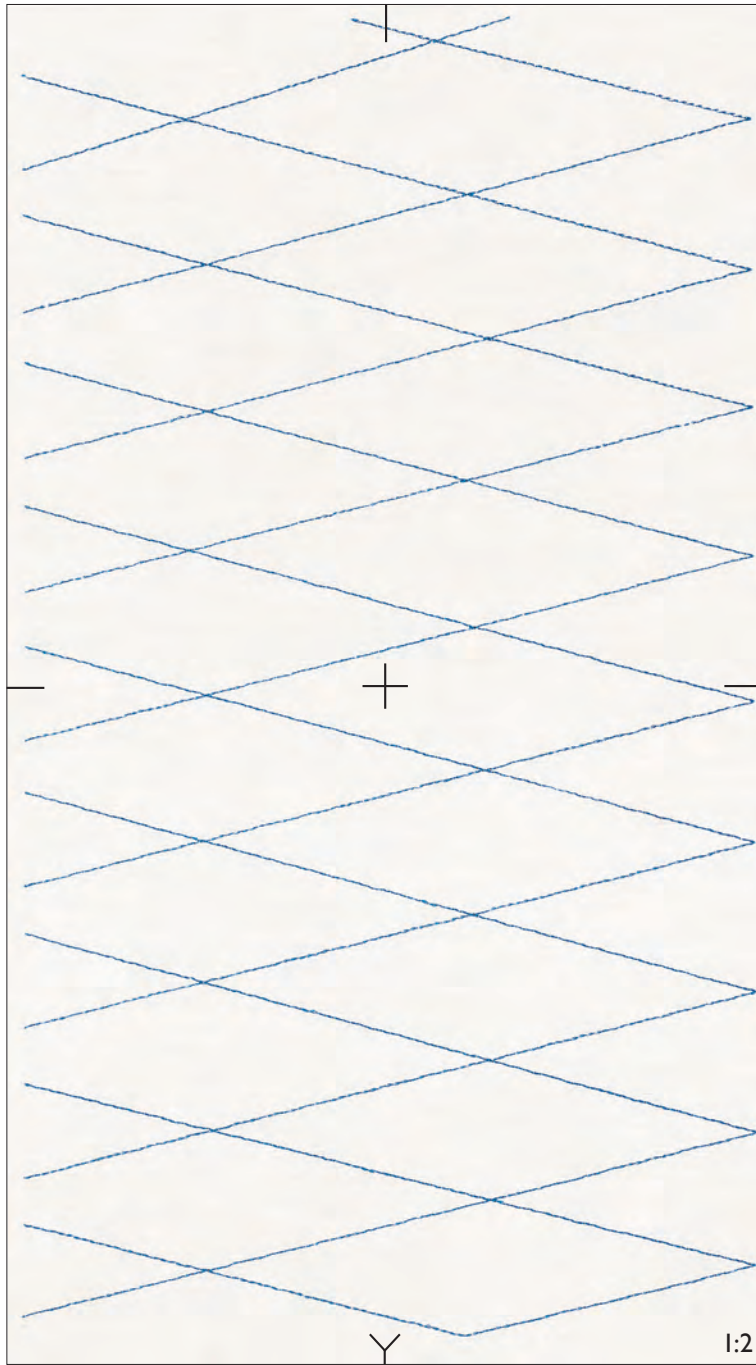

Stitches: 5 199
Height: 350 mm
Width: 195 mm











1  1251
2730

Gütermann Sulky
Robison - Anton

5

Stitches: 27 259
 Height: 156 mm
 Width: 159 mm
 Thread Velvet™

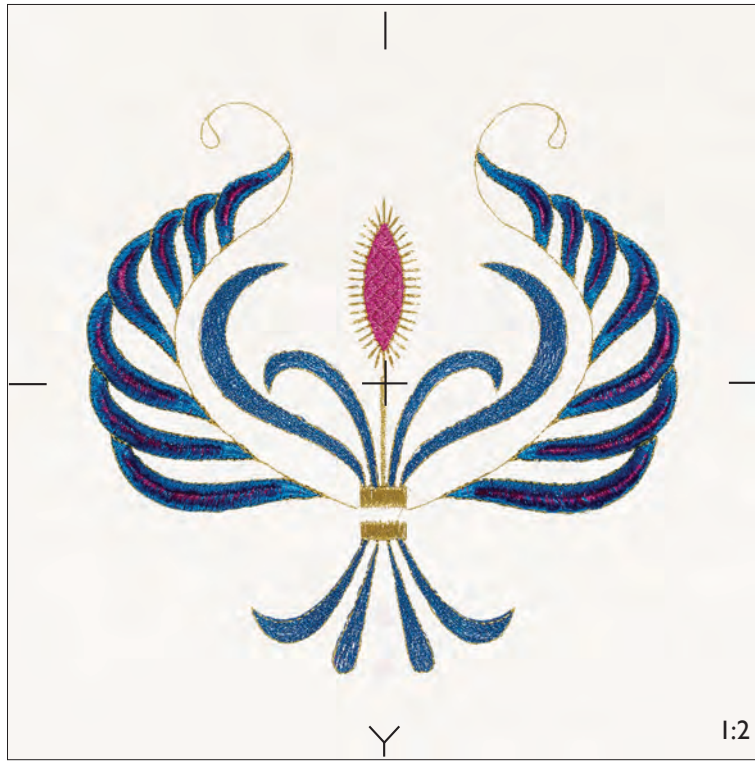

- 1  7052
1012
- 2  7052
1012
- 3  7007
1003
- 4  1191
2417
- 5  1251
2730
- 6  7007
1003
- 7  1191
2417
- 8  7007
1003
- 9  7021
1014

Gütermann Sulky
 Robison - Anton



6

Stitches: 3 950
 Height: 74 mm
 Width: 70 mm



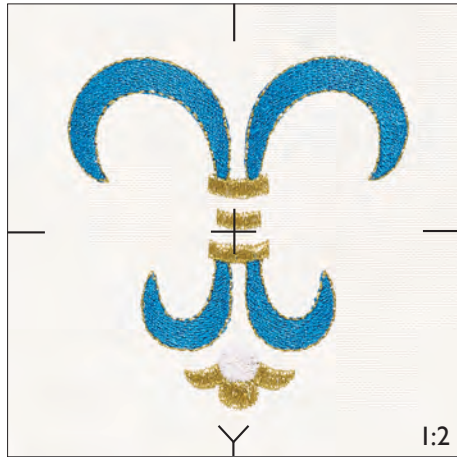

- 1  1251
2730
- 2  7007
1003
- 3  7021
1014

Gütermann Sulky
 Robison - Anton



7

Stitches: 8 432
 Height: 135 mm
 Width: 97 mm
 Thread Velvet™

- 1  1191
2417
- 2  1251
2730
- 3  7052
1012
- 4  7007
1003
- 5  7021
1014

Gütermann Sulky
 Robison - Anton

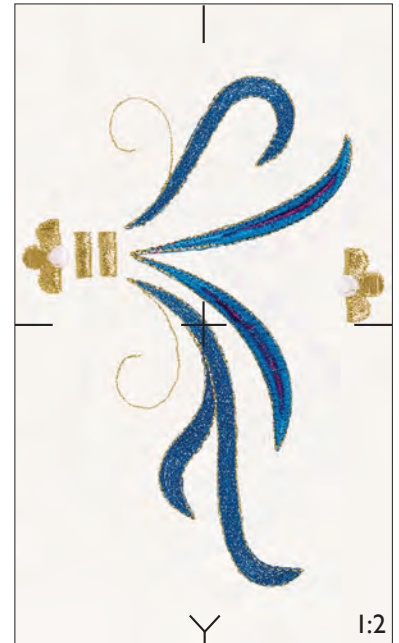



Stiches: 7 960
 Height: 135 mm
 Width: 84 mm
 Thread Velvet™

8

- 1 1191
2417
- 2 1251
2730
- 3 7052
1012
- 4 7007
1003
- 5 7021
1014

Gütermann Sulky
 Robison - Anton

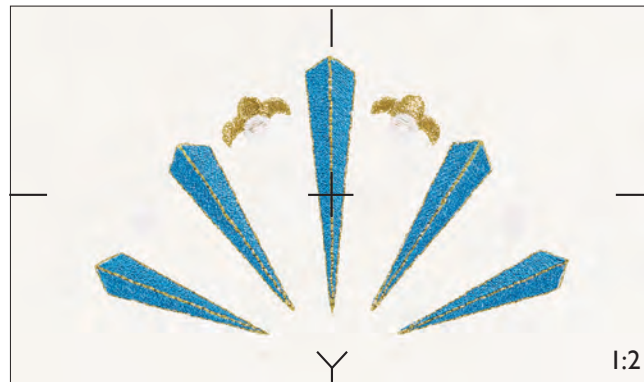

Stiches: 7 496
 Height: 74 mm
 Width: 126 mm

9

- 1 1251
2730
- 2 7007
1003
- 5 7021
1014

Gütermann Sulky
 Robison - Anton

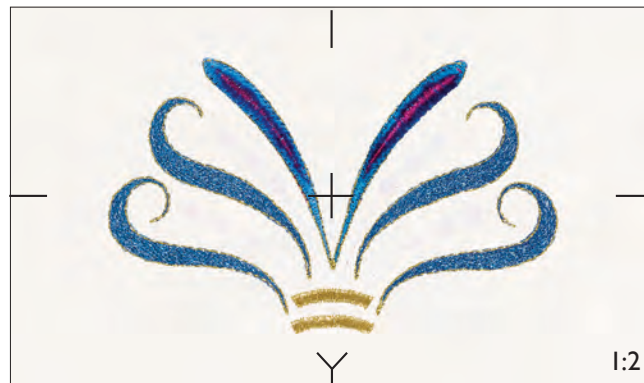

Stiches: 7 824
 Height: 73 mm
 Width: 119.6 mm
 Thread Velvet™



10

- 1 1191
2417
- 2 1251
2730
- 3 7052
1012
- 4 7007
1003
- 5 7021
1014

Gütermann Sulky
 Robison - Anton

11

Stitches: 2 207
Height: 49 mm
Width: 36 mm

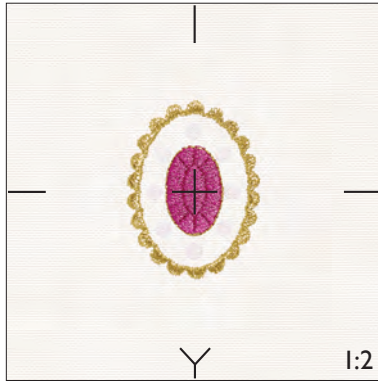

- 1  1191
2417
- 2  7021
1014
- 3  7007
1003

Gütermann Sulky
Robison - Anton



12

Stitches: 2 146
Height: 47 mm
Width: 36 mm

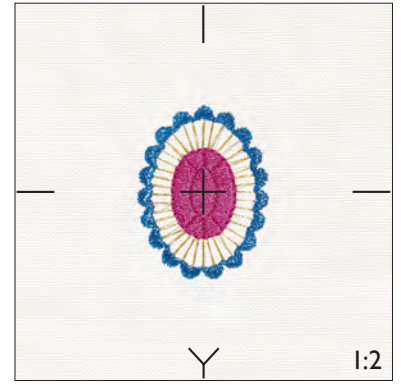

- 1  7007
1003
- 2  1191
2417
- 3  7052
1012

Gütermann Sulky
Robison - Anton



13

Stitches: 1 712
Height: 52 mm
Width: 40 mm

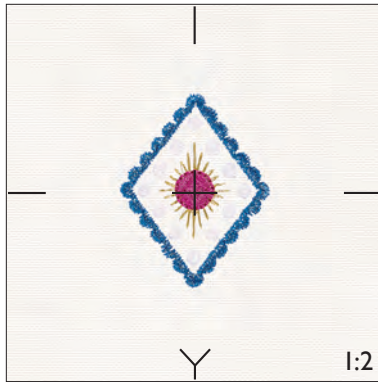

- 1  7007
1003
- 2  1191
2417
- 3  7021
1014
- 4  7052
1012

Gütermann Sulky
Robison - Anton



14

Stitches: 475
Height: 14 mm
Width: 23 mm



- 1  7007
1003
- 2  7021
1014

Gütermann Sulky
Robison - Anton



15

Stitches: 913
Height: 28 mm
Width: 28 mm

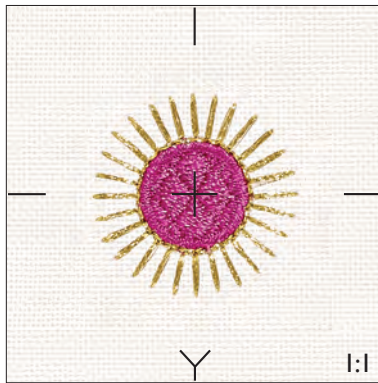

- 1  1191
2417
- 2  7007
1003

Gütermann Sulky
Robison - Anton



16

Stitches: 1 328
Height: 39 mm
Width: 37 mm

- 1  1251
2730
- 2  7007
1003
- 3  7021
1014

Gütermann Sulky
Robison - Anton

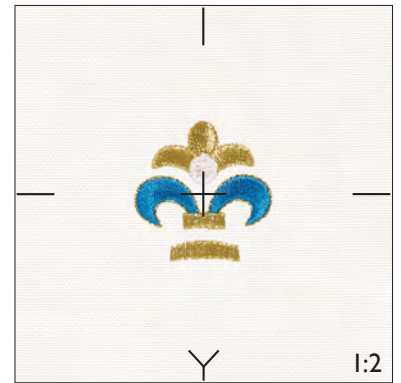



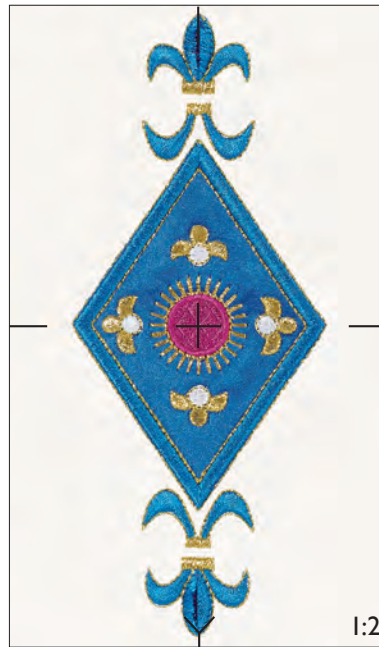

Stitches: 8 435
 Height: 165 mm
 Width: 68 mm
 Thread Velvet™

- 1 1251
2730
- * 2 1251
2730
- 3 1251
2730
- 4 1191
2417
- 5 7021
1014
- 6 7007
1003
- 7 1251
2730
- 8 1191
2417
- 9 1251
2730
- 10 7007
1003

Gütermann Sulky
 Robison - Anton

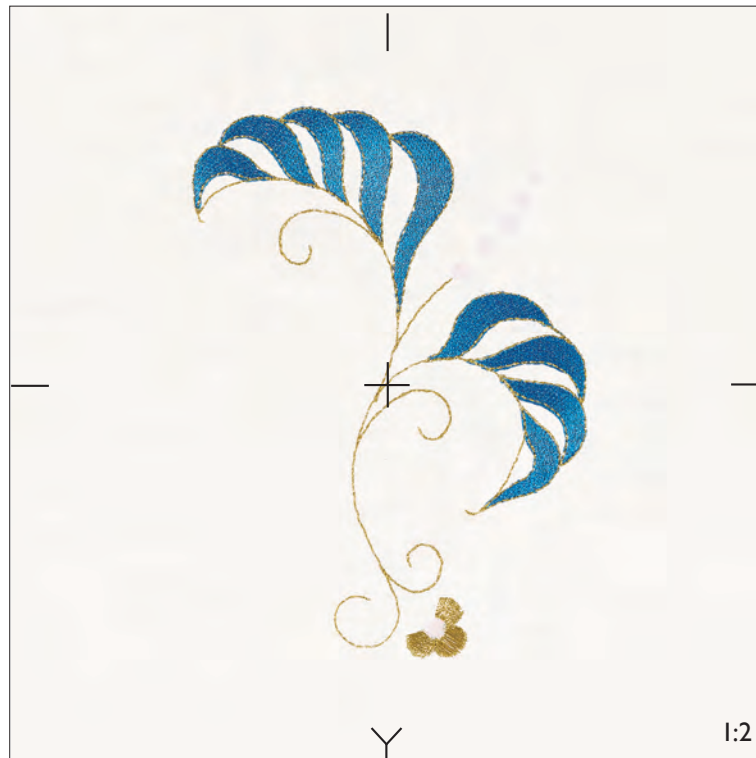



Stitches: 6 030
 Height: 146 mm
 Width: 106 mm

- 1 1251
2730
- 2 7007
1003
- 3 7021
1014

Gütermann Sulky
 Robison - Anton

19

Stitches: 3 779
Height: 119 mm
Width: 62 mm









- 1  1251
2730
- 2  7007
1003
- 3  7021
1014

Gütermann Sulky
Robison - Anton



20

Stitches: 9 037
Height: 97 mm
Width: 121 mm





- 1  1251
2730
- 2  1191
2417
- 3  7007
1003
- 4  1251
2730
- 5  7021
1014
- 6  7007
1003
- 7  7007
1003
- 8  7021
1014

Gütermann Sulky
Robison - Anton



21

Stitches: 6 161
Height: 54 mm
Width: 115 mm

- 1  7007
1003
- 2  1251
2730
- 3  1191
2417
- 4  1063
2343
- 5  7007
1003

Gütermann Sulky
Robison - Anton

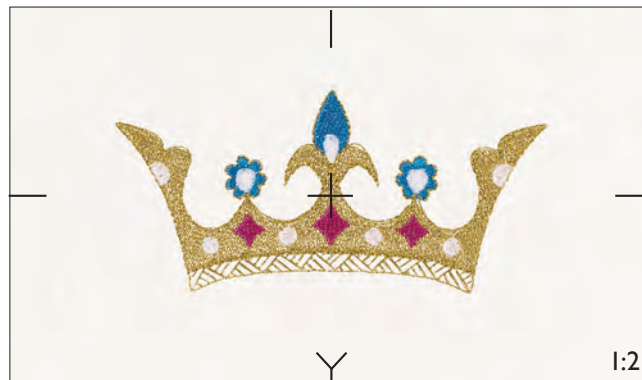



Stitches: 20 939
 Height: 226 mm
 Width: 111 mm

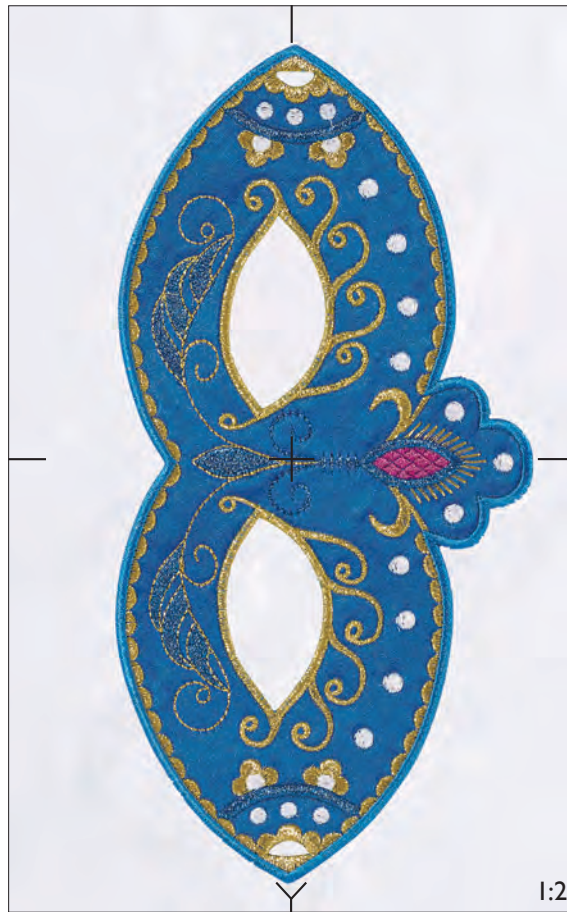

- 1 1251
2730
- * 1251
2730
- 2 1251
2730
- ✂ 1251
2730
- 3 1251
2730
- 4 1191
2417
- 5 7052
1012
- 6 7007
1003
- 7 1063
2343
- 8 7052
1012
- 9 7007
1003
- 10 1251
2730

Gütermann Sulky
 Robison - Anton

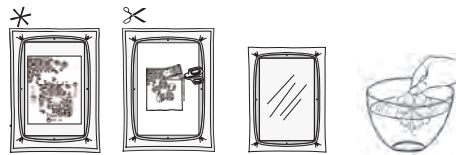

1:2

Stitches: 43 929
 Height: 111 mm
 Width: 136 mm

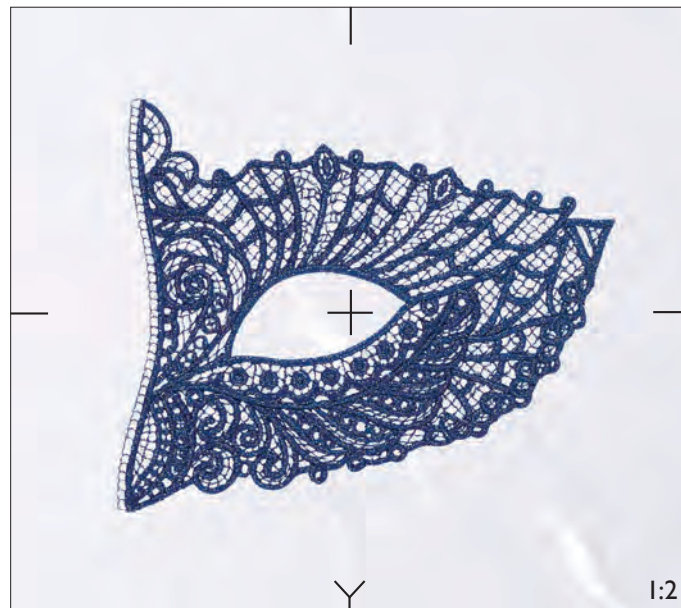

- 1 7052
1012

Gütermann Sulky
 Robison - Anton



1:2

24

Stitches: 6 870
Height: 273 mm
Width: 132 mm





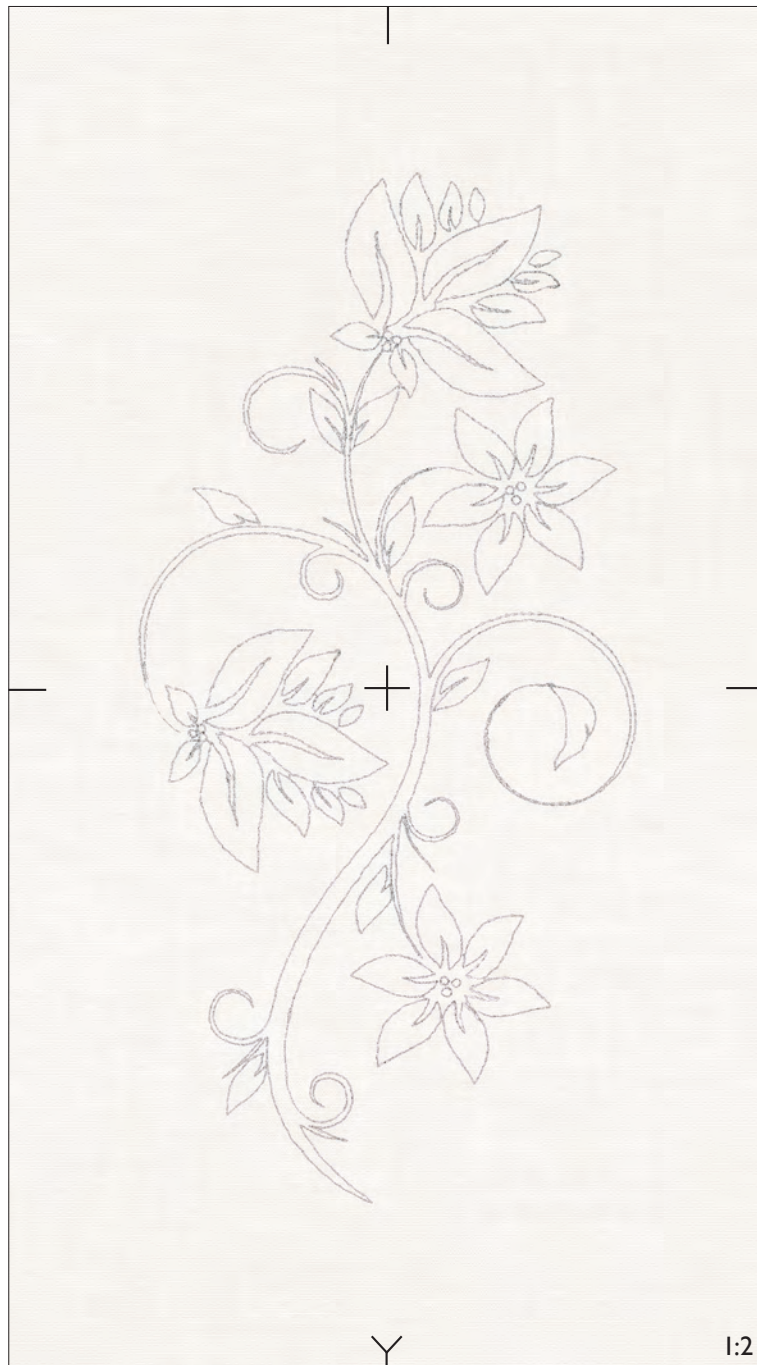

1  7023
1005

Gütermann Sulky
Robison - Anton



Stiches: 5 199
Höhe: 273 mm
Width: 132 mm



- 1  7023
1005
- 2  1251
2730
- 3  1251
2730
- 4  7023
1005
- 5  7023
1005
- 6  7023
1005

Gütermann Sulky
Robison - Anton

26

Stitches: 519
Height: 32 mm
Width: 34 mm

1  1251
2730

✂

Gütermann Sulky
Robison - Anton

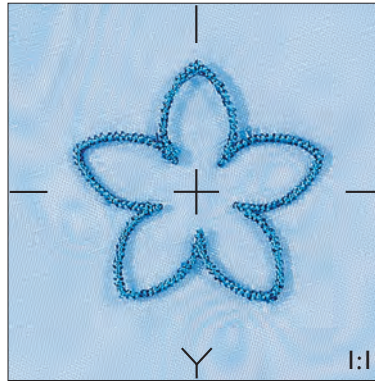

27

Stitches: 368
Height: 35 mm
Width: 35 mm

1  1251
2730

✂

Gütermann Sulky
Robison - Anton

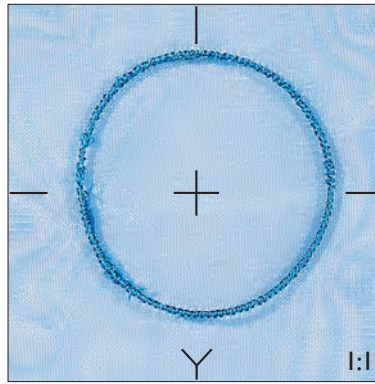

28

Stitches: 342
Height: 19 mm
Width: 27 mm

1  1251
2730

✂

Gütermann Sulky
Robison - Anton

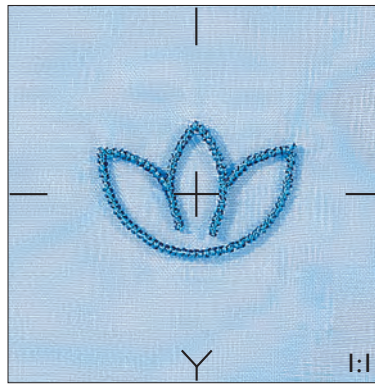



29

Stitches: 12 515
Height: 338 mm
Width: 189 mm

1  8017





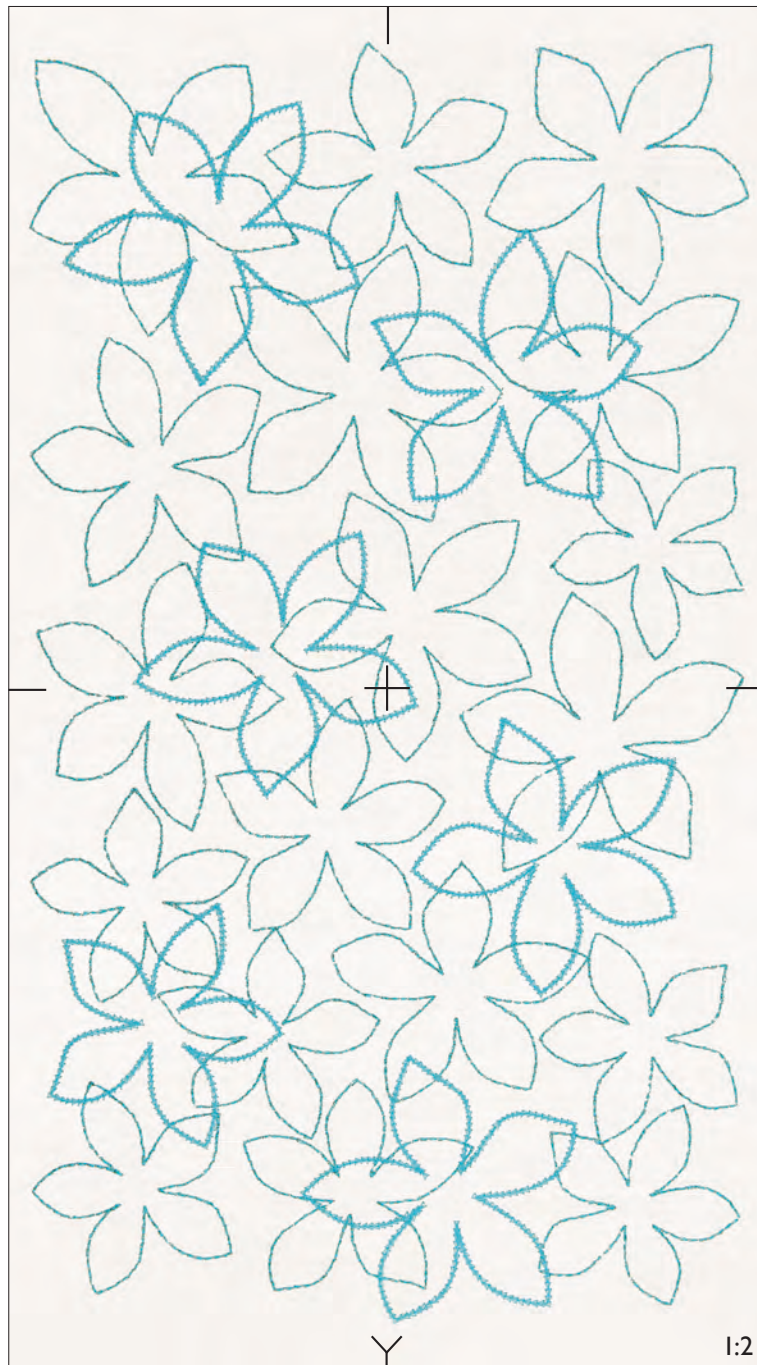







2  60 wt Silk

Gütermann Sulky



Stitches: 42 712
 Height: 340 mm
 Width: 119 mm
 Thread Velvet™



- 1  8017
- 2  1251
2730
- 3  1095
2306
- 4  1095
2518
- 5  1250
2520
- 6  7009
1006
- 7  1095
2518
- *  1095
2518
- ∞  1095
2518
- 10  7009
1006
- 11  1090
2519
- 12  1251
2740
- 13  1560
2305

Gütermann Sulky
 Robison - Anton





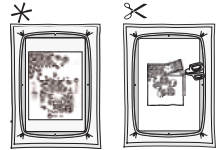



Y

1:2



31

Stitches: 38 327
Height: 334 mm
Width: 180 mm
Thread Velvet™

- 1  8017
- 2  1251
2740
- 3  1095
2518
- 4  1095
2306
- 5  1250
2520
- 6  7009
1006
- 7  1251
2740
- 8  1560
2305





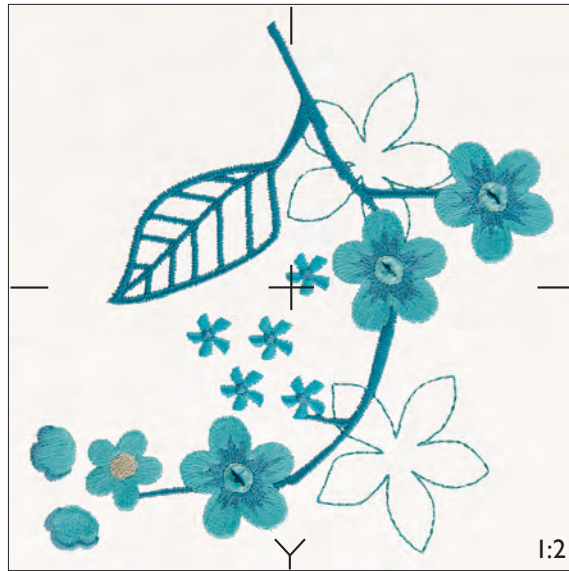



Gütermann Sulky
Robison - Anton





Stiches: 13 592
 Heigt: 143 mm
 Widtb: 139 mm
 Thread Velvet™

32

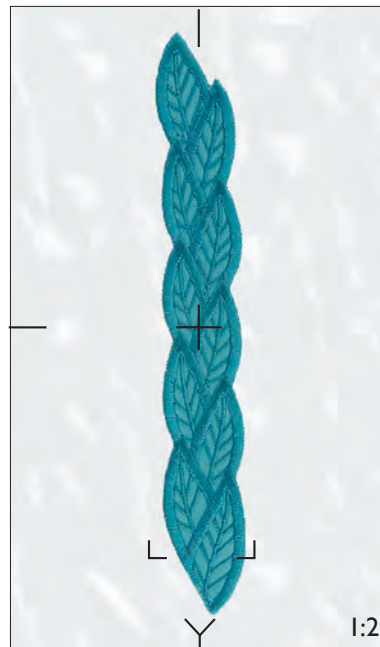

- 1  8017
- 2  1251
2740
- 3  1095
2518
- 4  1095
2518
- 5  1250
2520
- 6  7009
1006
- 7  1251
2740
- 8  1560
2305

Gütermann Sulky
 Robison - Anton



Stiches: 7 252
 Heigt: 158 mm
 Widtb: 28 mm







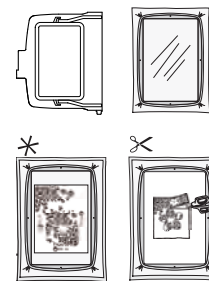













33

- *
1  1090
2519
- 2  1090
2519
- 3  1090
2519

Gütermann Sulky
 Robison - Anton



Stitches: 40 915
 Height: 348 mm
 Width: 195 mm
 Thread Velvet™

- | | | |
|----|-------------------------------------------------------------------------------------|--------------|
| 1 |  | 1080
2588 |
| 2 |  | 1192
2500 |
| 3 |  | 1332
2279 |
| 4 |  | 1104
2547 |
| 5 |  | 1550
2607 |
| 6 |  | 1045
2310 |
| 7 |  | 1285
2594 |
| 8 |  | 1513
2446 |
| 9 |  | 1184
2467 |
| 10 |  | 1039
2508 |
| 11 |  | 1533
2504 |
| 12 |  | 1256
2259 |
| 13 |  | 1169
2249 |
| 14 |  | 1309
2418 |
| 15 |  | 1025
2400 |
| 16 |  | 1124
2325 |
| 17 |  | 1192
2500 |
| 18 |  | 1285
2594 |
| 19 |  | 1029
2433 |
| 20 |  | 1074
2300 |

Gütermann Sulky
 Robison - Anton























Stiches: 46 117
 Height: 354 mm
 Width: 185 mm
 Thread Velvet™



- 1 1080
2588
- 2 1192
2500
- 3 1332
2279
- 4 1104
2547
- 5 1550
2607
- 6 1045
2310
- 7 1285
2594
- 8 1513
2446
- 9 1184
2467
- 10 1039
2508
- 11 1533
2504
- 12 1256
2259
- 13 1169
2249
- 14 1309
2418
- 15 1025
2400
- 16 1124
2325
- 17 1192
2500
- 18 1285
2594
- 19 1029
2433
- 20 1074
2300

Gütermann Sulky
 Robison - Anton

Stitches: 54 514
 Height: 350 mm
 Width: 195 mm
 Thread Velvet™

- | | | |
|----|-------------------------------------------------------------------------------------|--------------|
| 1 |  | 1080
2588 |
| 2 |  | 1192
2500 |
| 3 |  | 1332
2279 |
| 4 |  | 1104
2547 |
| 5 |  | 1550
2607 |
| 6 |  | 1045
2310 |
| 7 |  | 1285
2594 |
| 8 |  | 1513
2446 |
| 9 |  | 1184
2467 |
| 10 |  | 1039
2508 |
| 11 |  | 1533
2504 |
| 12 |  | 1256
2259 |
| 13 |  | 1169
2249 |
| 14 |  | 1309
2418 |
| 15 |  | 1025
2400 |
| 16 |  | 1124
2325 |
| 17 |  | 1192
2500 |
| 18 |  | 1285
2594 |
| 19 |  | 1029
2433 |
| 20 |  | 1074
2300 |





Gütermann Sulky
 Robison - Anton





37

Stitches: 7 427
Height: 290 mm
Width: 150 mm

- 1  1147
2378
- 2  1169
Cotton 30 wt
- 3  1169
Cotton 30 wt
- 4  7055
1009
- 5  1257
2509



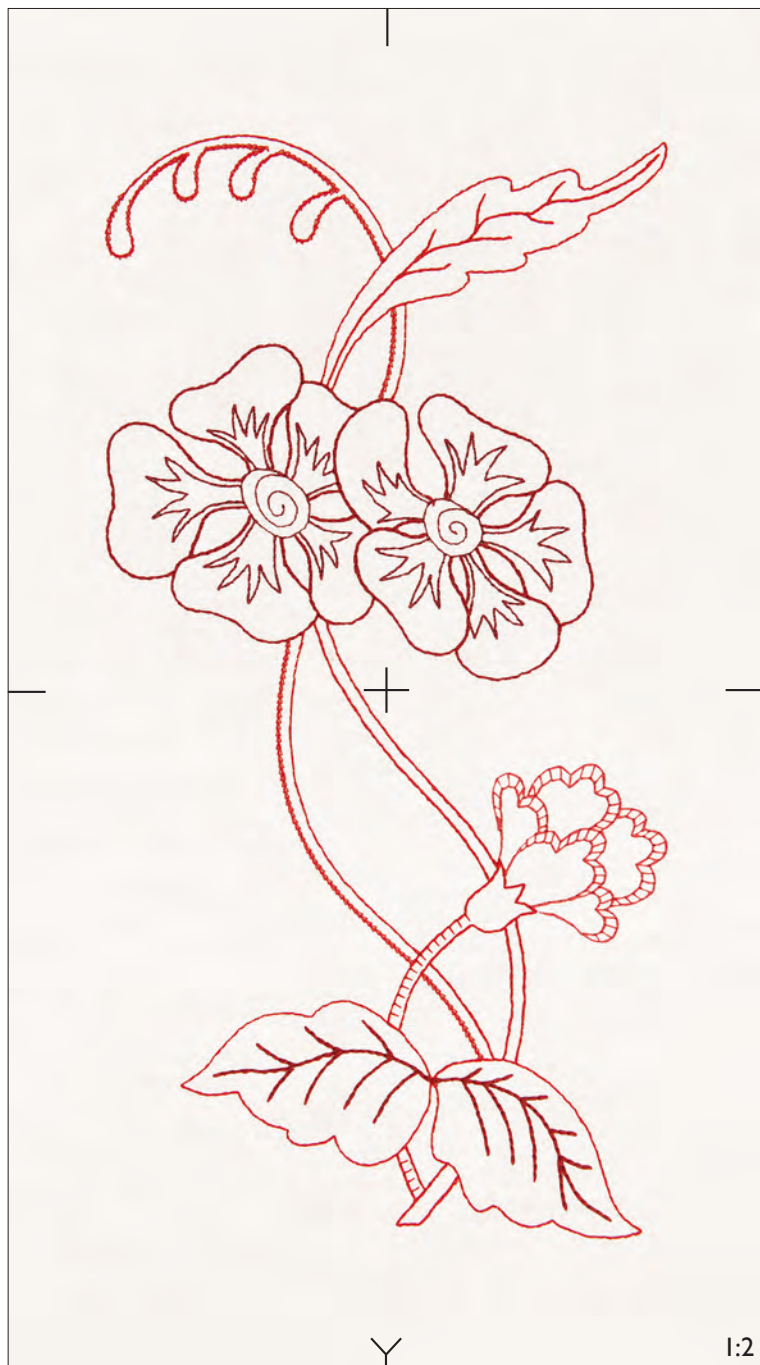

Gütermann Sulky
Robison - Anton

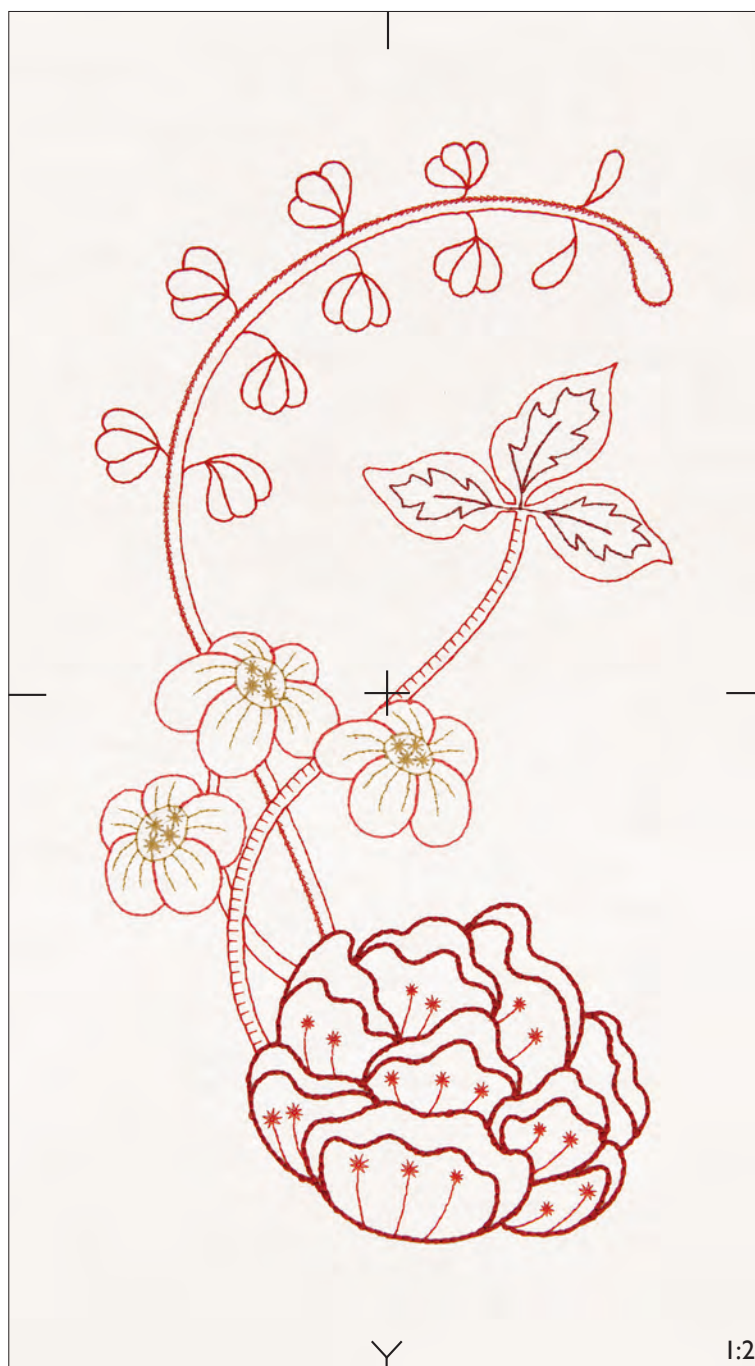

Stiches: 8 854
Höhe: 290 mm
Weite: 153 mm

38



- 1  1147
2378
- 2  1169
Cotton 30 wt
- 3  7013
1009
- 4  7007
1001
- 5  1257
2509





Gütermann Sulky
Robison - Anton

Y

1:2

39

Stitches: 8 049
Height: 290 mm
Width: 152 mm

- 1  1147
2378
- 2  7007
1001
- 3  1169
Cotton 30 wt
- 4  1257
2509
- 5  7054
1004

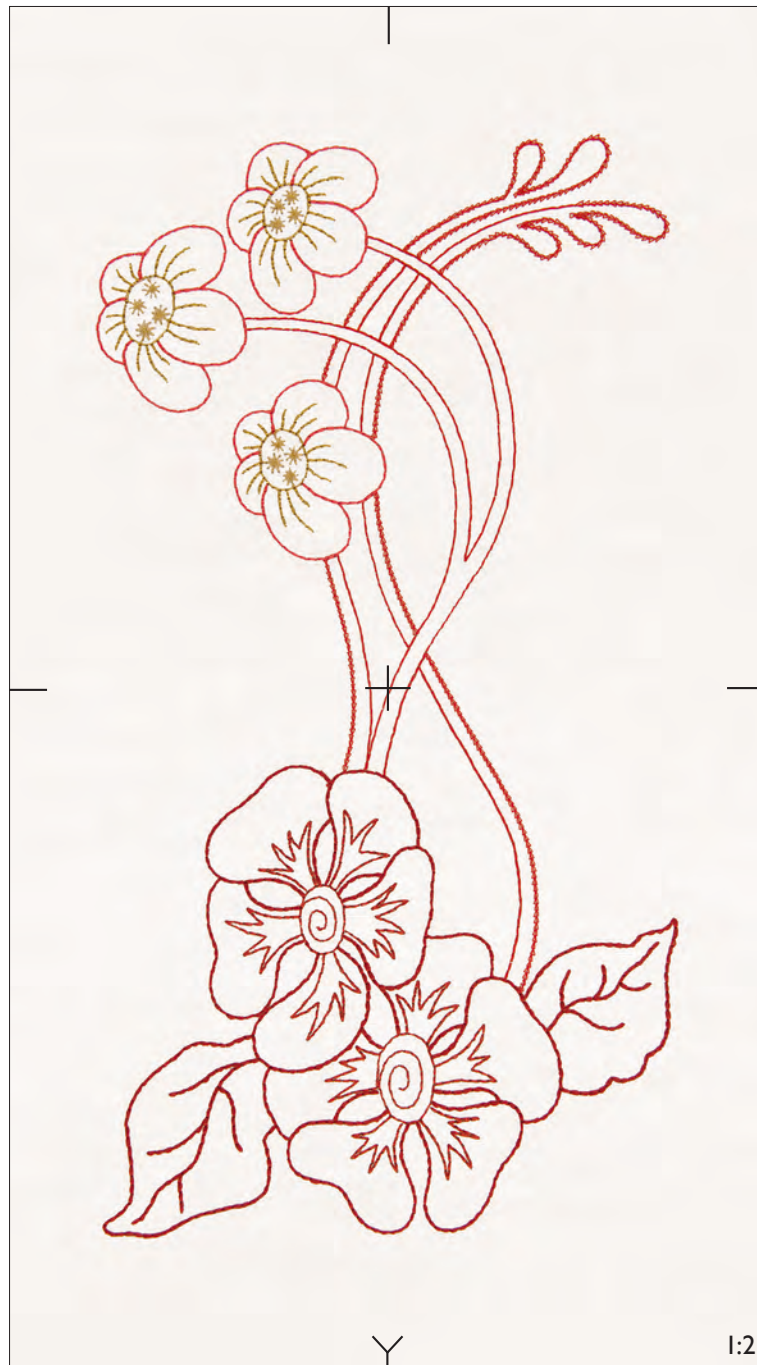

Gütermann Sulky
Robison - Anton

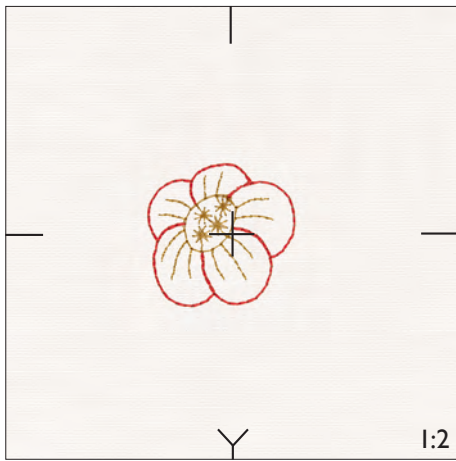



40

Stitches: 455
Height: 38 mm
Width: 39 mm



- 1  7007
1001
- 2  1257
2509

Gütermann Sulky
Robison - Anton



41

Stitches: 947
Height: 57 mm
Width: 86 mm

- 1  7007
1001
- 2  1257
2509

Gütermann Sulky
Robison - Anton

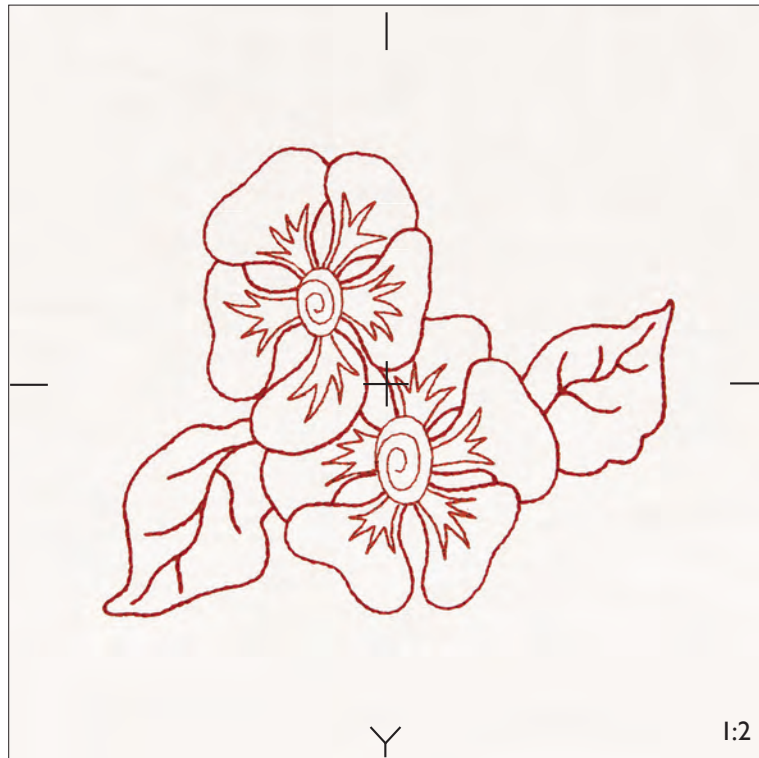

42

Stitches: 3 717
Height: 125 mm
Width: 151 mm

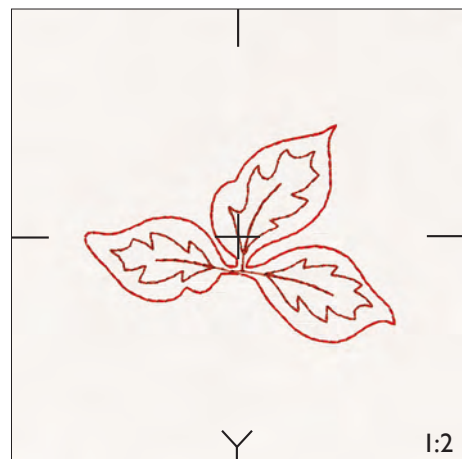

- 1  1169
Cotton 30 wt
- 2  7054
1004

Gütermann Sulky
Robison - Anton



















43

Stitches: 894
Height: 58 mm
Width: 82 mm

- 1  1147
2378
- 2  7013
1009

Gütermann Sulky
Robison - Anton

Stitches: 36 922
 Height: 320 mm
 Width: 147 mm
 Thread Velvet™

- 1  1287
2221
- 2  1104
2547
- 3  1276
2572
- 4  1104
2547
- 5  1287
2221
- 6  1047
2238
- 7  1117
2276
- *  1117
2276
- ✂  1117
2276
- 10  1034
2611
- 11  1307
2248
- 12  1309
2418
- 13  1313
2398
- 14  1034
2611
- 15  1533
2504
- 16  1307
2248

Gütermann Sulky
 Robison - Anton

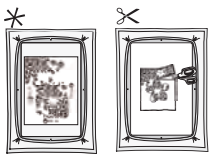



Stitches: 106 675
 Height: 335 mm
 Width: 323 mm
 Thread Velvet™



1:1	1064 2377	1:9	1313 2398	1:17	1287 2221	2:3	1034 2611	2:11	1104 2547	2:19	1172 2308
*											
1:2	1117 2276	1:10	1239 2394	1:18	1047 2238	2:4	1313 2398	2:12	1287 2221	2:20	1117 2276
✂								*			
1:3	1117 2276	1:11	621 2581	1:19	1074 2300	2:5	1239 2394	2:13	1047 2238	2:21	1117 2276
								✂			
1:4	1307 2248	1:12	1021 2289	1:20	1291 2536	2:6	621 2581	2:14	1074 2300	2:22	1117 2276
								*			
1:5	1119 2591	1:13	1287 2221	1:21	1283 2386	2:7	1021 2289	2:15	1172 2308	2:23	1034 2611
								✂			
1:6	1034 2611	1:14	1104 2547	1:22	1172 2308	2:8	1276 2572	2:16	1172 2308	2:24	
1:7	1533 2504	1:15	1276 2572	2:1	1064 2377	2:9	1104 2547	2:17	1283 2386	2:25	1533 2504
1:8	1307 2248	1:16	1104 2547	2:2	1119 2591	2:10	1276 2572	2:18	1294 2613	2:26	

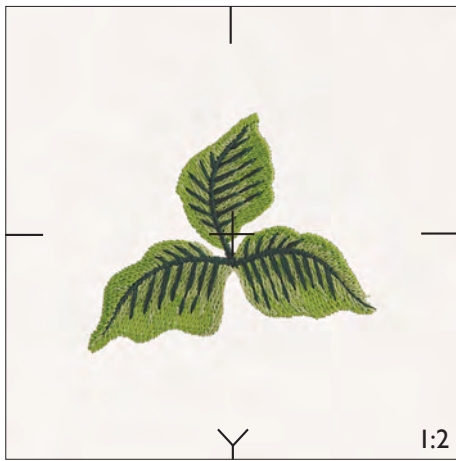

46

Stitches: 5 085
 Height: 65 mm
 Width: 51 mm

- 1 1332
2279
- 2 1104
2547
- 3 1550
2607

Gütermann Sulky
 Robison - Anton

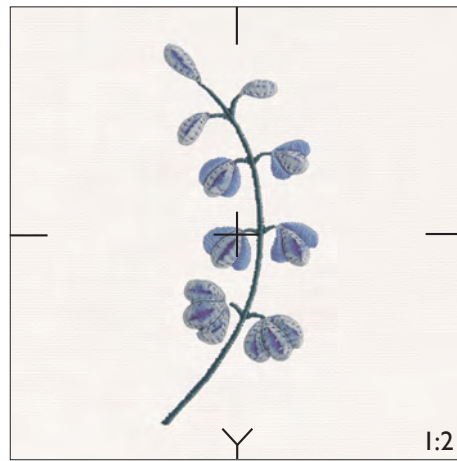

47

Stitches: 5 667
 Height: 102 mm
 Width: 42 mm
 Thread Velvet™

- 1 1285
2594
- 2 1029
2433
- 3 1074
2300

Gütermann Sulky
 Robison - Anton

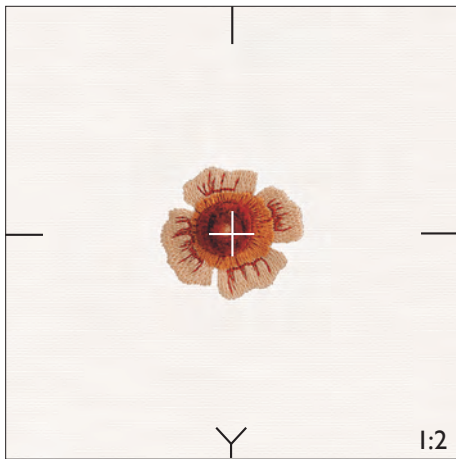

48

Stitches: 3 358
 Height: 37 mm
 Width: 38 mm
 Thread Velvet™

- 1 1258
2398
- 2 1258
2398
- 3 1239
2394
- 4 621
2581
- 5 1021
2289

Gütermann Sulky
 Robison - Anton



49

Stitches: 3 230
 Height: 87 mm
 Width: 45 mm

- 1 1080
2588
- 2 1192
2500
- 3 1332
2279
- 4 1104
2547

Gütermann Sulky
 Robison - Anton

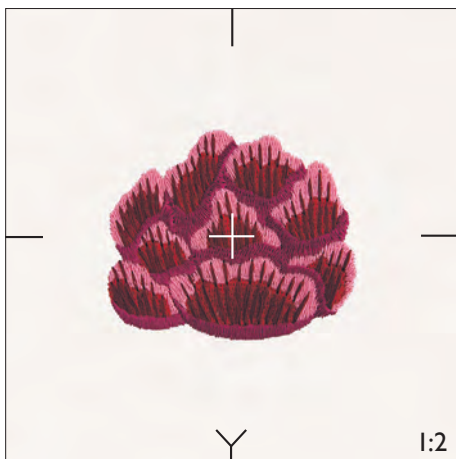

50

Stitches: 8 209
 Height: 59 mm
 Width: 65 mm

- 1 1533
2504
- 2 1256
2259
- 3 1309
2418
- 4 1192
2500

Gütermann Sulky
 Robison - Anton

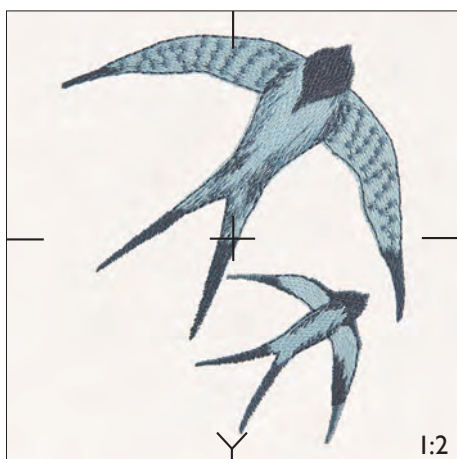

51



Stitches: 6 396
 Height: 109 mm
 Width: 91 mm

- 1 1074
2300
- 2 1223
2382
- 3 1172
2308
- 4 1283
2386

Gütermann Sulky
 Robison - Anton

52

Stitches: 24 553
Height: 349 mm
Width: 156 mm

- 1  1220
2217
- 2  1011
2618

Gütermann Sulky
Robison - Anton





Stiches: 13 609
Höight: 237 mm
Widtb: 189 mm

53

1  1011
2618

Gütermann Sulky
Robison - Anton

54

Stitches: 8 966
Height: 200 mm
Width: 168 mm



1  1011
2618

Gütermann Sulky
Robison - Anton



55

Stitches: 33 067
Height: 189 mm
Width: 141 mm
Thread Velvet™

1  1220
2217
2  1011
2618



Gütermann Sulky
Robison - Anton





56

Stitches: 14 356
Height: 169 mm
Width: 156 mm

- 1  1220
2217
- 2  1011
2618

Gütermann Sulky
Robison - Anton



57

Stitches: 1 231
Height: 81 mm
Width: 112 mm

- 1  1535
2527

Gütermann Sulky
Robison - Anton

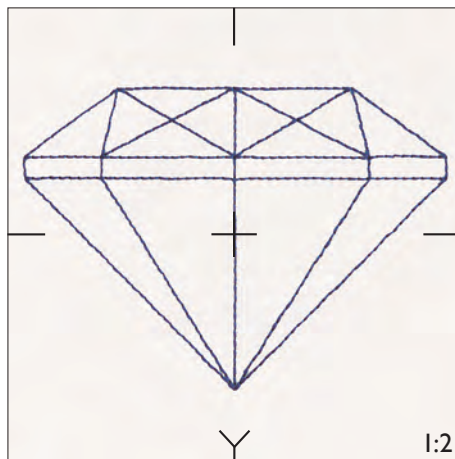

Stiches: 3 722
Höhe: 355 mm
Weite: 81 mm

58

1  1535
2527

Gütermann Sulky
Robison - Anton

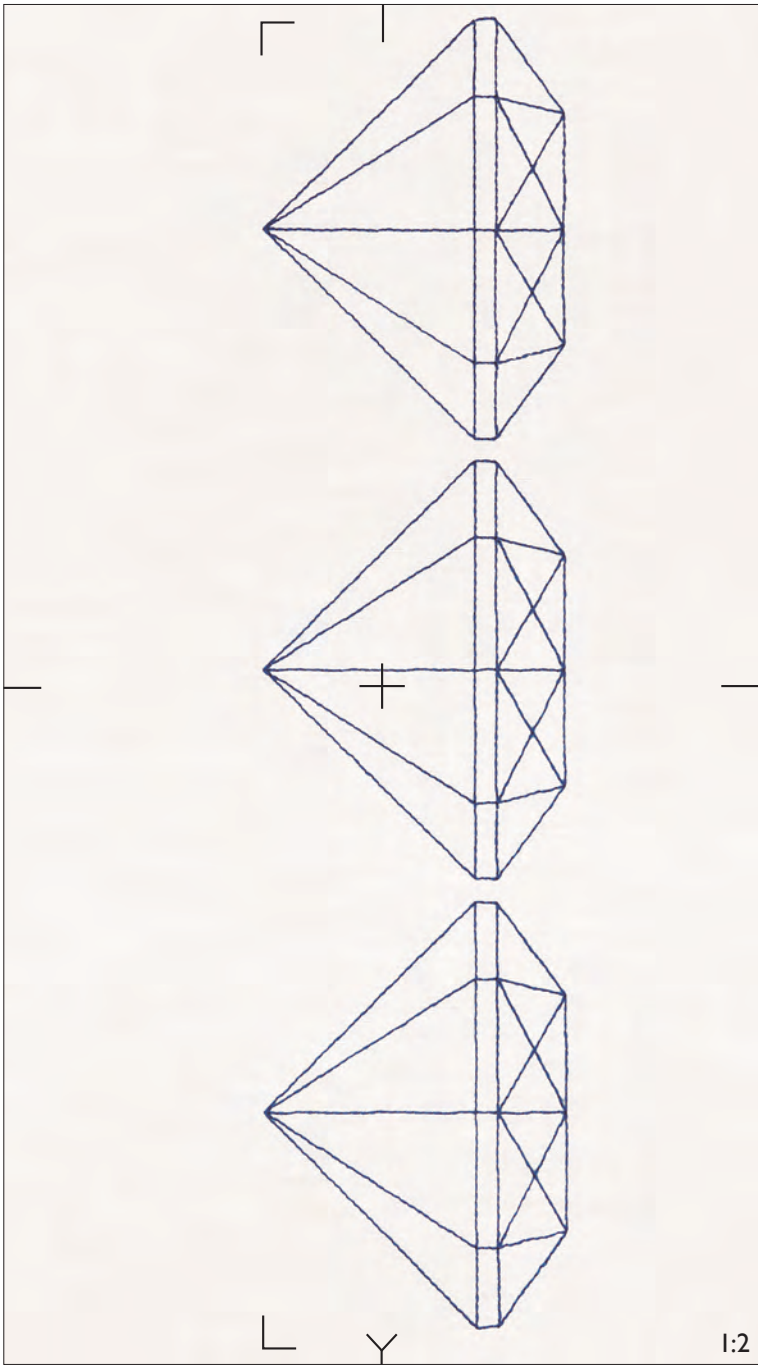

59

Stitches: 26 275
Height: 205 mm
Width: 194 mm

- 1 1037
2420
- 2 1020
2414
- 3 1071
2343

Gütermann Sulky
Robison - Anton



60

Stitches: 3 666
Height: 70 mm
Width: 66 mm

- 1 1037
2420
- 2 1020
2414
- 3 1071
2343

Gütermann Sulky
Robison - Anton

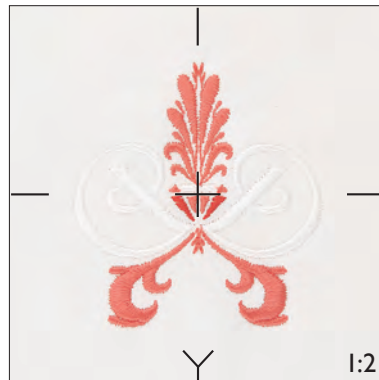

61

Stitches: 2 007
Height: 47 mm
Width: 46 mm

- 1 1037
2420
- 2 1020
2414
- 3 1071
2343

Gütermann Sulky
Robison - Anton

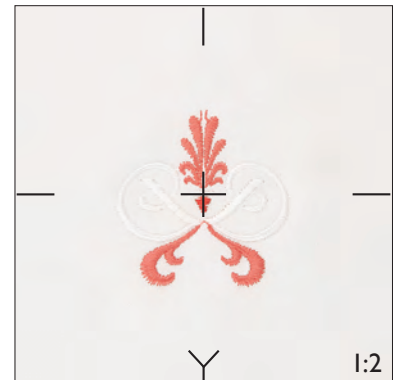



62

Stitches: 16 805
 Height: 64 mm
 Width: 64 mm
 Thread Velvet™

- 1 1169
2249
- 2 1039
2508
- 3 1169
2249
- 4 1039
2508

Gütermann Sulky
 Robison - Anton

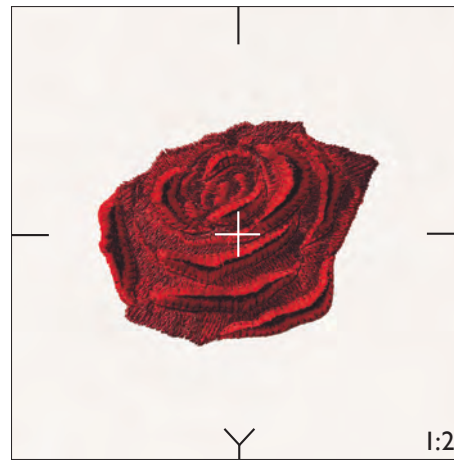

63

Stitches: 15 101
 Height: 60 mm
 Width: 75 mm
 Thread Velvet™

- 1 1169
2249
- 2 1039
2508
- 3 1169
2249
- 4 1039
2508

Gütermann Sulky
 Robison - Anton

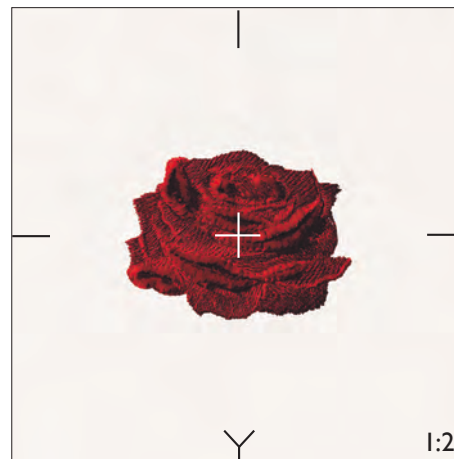

64

Stitches: 10 219
 Height: 47 mm
 Width: 62 mm
 Thread Velvet™

- 1 1169
2249
- 2 1039
2508
- 3 1263
2263
- 4 1039
2508

Gütermann Sulky
 Robison - Anton



65

Stitches: 15 077
 Height: 124 mm
 Width: 89 mm

- 1 1063
2316
- 2 1001
2343
- 3 1177
2457
- 4 1104
2547

Gütermann Sulky
 Robison - Anton

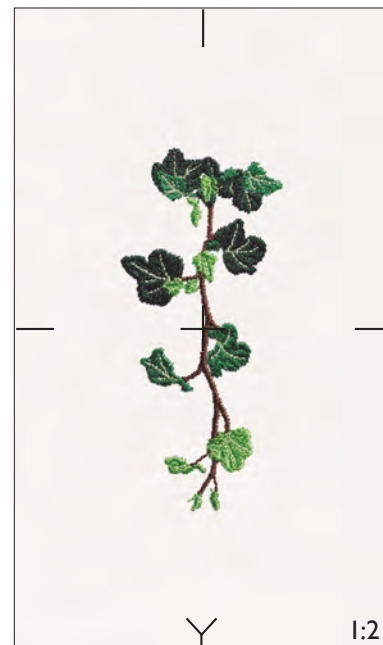

66

Stitches: 4 714
 Height: 95 mm
 Width: 42 mm

- 1 1057
2478
- 2 1550
2631
- 3 1208
2284
- 4 1177
2321
- 5 1176
2279

Gütermann Sulky
 Robison - Anton





Stiches: 10 530
 Heigt: 130 mm
 Widtb: 84 mm

- 1 1022
2316
- 2 1177
2457
- 3 1002
2574
- 4 1071
2574
- 5 2103
2328

Gütermann Sulky
 Robison - Anton

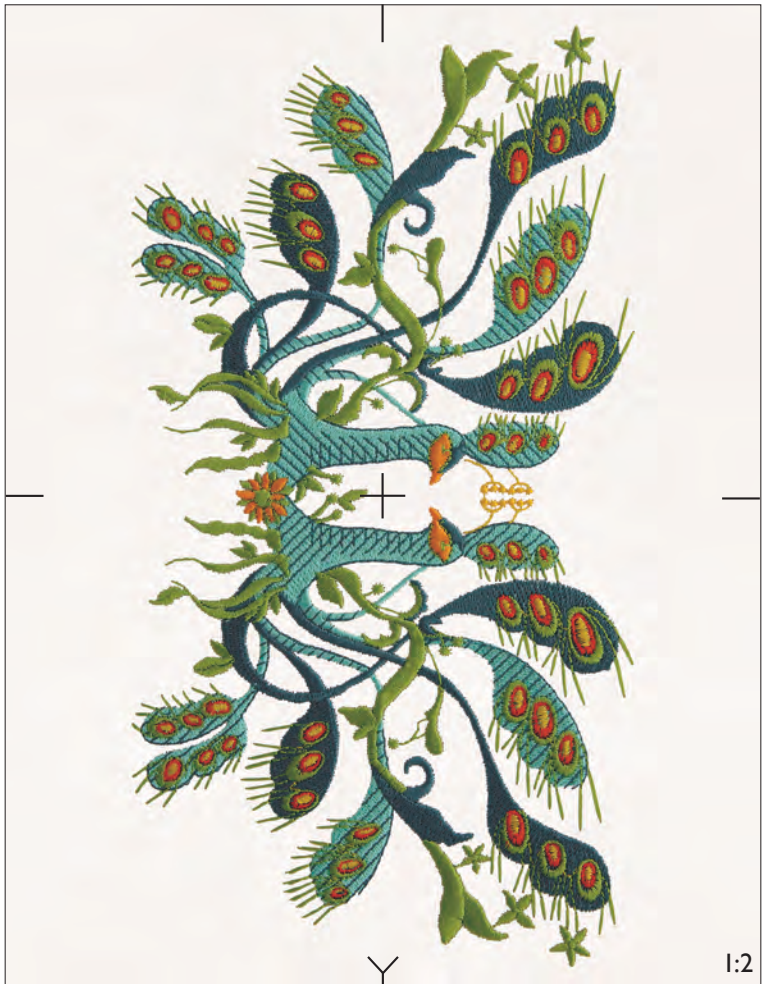









Stiches: 45 343
 Heigt: 250 mm
 Widtb: 135 mm

- 1 1045
2310
- 2 1285
2594
- 3 1238
2409
- 4 1332
2279
- 5 1124
2325
- 6 1184
2467
- 7 1332
2279

Gütermann Sulky
 Robison - Anton

69

Stitches: 38 548
Height: 342 mm
Width: 140 mm

- 1  1031
2340
- 2  1254
2286
- 3  1031
2340
- 4  1032
2288
- 5  1177
2457
- 6  1104
2547
- 7  1220
2217
- 8  1104
2547
- 9  1177
2457





Gütermann Sulky
Robison - Anton



1:2









Stiches: 31 595
Height: 342 mm
Width: 188 mm

- 1  1177
2457
- 2  1104
2547
- 3  1232
2315
- 4  1001
2343

Gütermann Sulky
Robison - Anton

71

Stitches: 28 888
Height: 340 mm
Width: 185 mm























- 1  1025
2400
- 2  1005
2296
- 3  1001
2343
- 4  1025
2400
- 5  1005
2296
- 6  1001
2343

Gütermann Sulky
Robison - Anton



Stiches: 57 529
 Height: 336 mm
 Width: 70 mm



- 1  1022
2316
- 2  1022
2316
- 3  1031
2340
- 4  1022
2316
- 5  1194
2288
- 6  1104
2547
- 7  1276
2572
- 8  1332
2279
- 9  1104
2547
- 10  1177
2457
- 11  1272
2317
- 12  1022
2316
- 13  1022
2316
- 14  1031
2340
- 15  1022
2316
- 16  1194
2288
- 17  1104
2547
- 18  1276
2572
- 19  1332
2279
- 20  1104
2547
- 21  1177
2457
- 22  1272
2317

Gütermann Sulky
 Robison - Anton

187 Mega Richelieu, design #9

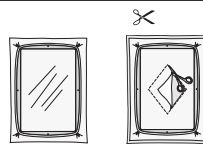

73

Stitches: 6 275
Height: 98 mm
Width: 69 mm

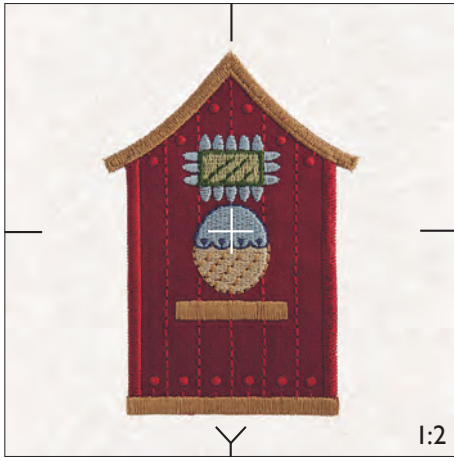

- 1 1034 2611
- 2 1034 2611
- * 1034 2611
- 3 1034 2611
- < 1127 2476
- 4 1128 2273
- 5 1248 2239
- 6 1042 2210
- 7 1104 2547
- 8 1176 2595

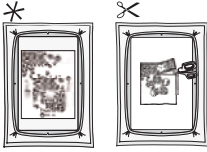

Gütermann Sulky
Robison - Anton



75

Stitches: 36 037
Height: 347 mm
Width: 183 mm

- 1 1056 2231
- 2 1070 2557
- 3 1129 2372
- 4 1117 2276
- 5 1147 2263
- 6 1104 2547
- 7 1176 2595
- 8 1248 2239
- 9 1042 2210
- 10 1127 2476
- 11 1082 2232
- 12 1128 2273
- 13 1056 2231
- 14 1129 2569
- 15 1170 2402
- 16 1104 2547
- 17 1176 2595
- 18 1135 2234
- 19 1023 2561
- 20 1117 2276
- 21 1147 2263
- 22 1177 2457
- 23 1176 2595
- 24 0502 2398
- 25 1028 2206
- 26 1028 2206

Gütermann Sulky
Robison - Anton

74

Stitches: 6 168
Height: 117 mm
Width: 64 mm

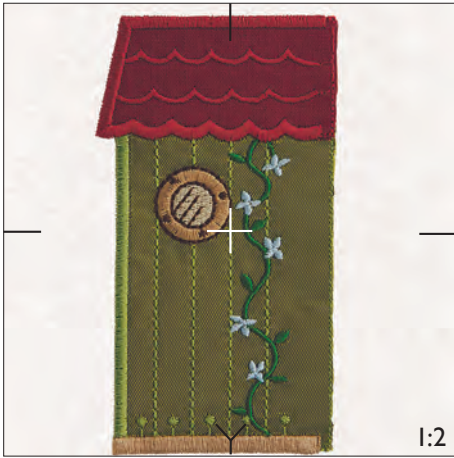

- 1 1177 2457
- * 1177 2457
- 2 1177 2457
- 3 1177 2457
- 4 1051 2453
- 5 1248 2239
- 6 1127 2476
- 7 1128 2273
- 8 1129 2372
- 9 1034 2611
- * 1034 2611
- < 1034 2611
- 11 1034 2611

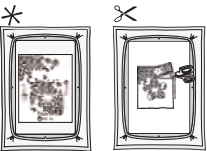

Gütermann Sulky
Robison - Anton

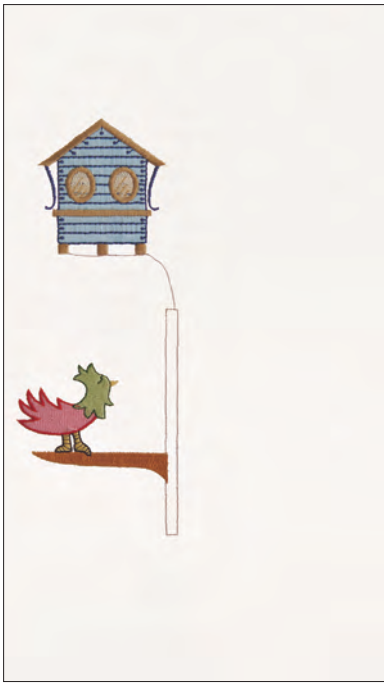

Step 1

- | | | | | | |
|---|--------------|---|--------------|----|--------------|
| 1 | 1056
2231 | 5 | 1147
2263 | 9 | 1042
2210 |
| 2 | 1070
2557 | 6 | 1104
2547 | 10 | 1127
2476 |
| 3 | 1129
2372 | 7 | 1176
2595 | 11 | 1082
2232 |
| 4 | 1117
2276 | 8 | 1248
2239 | 12 | 1128
2273 |



Step 2

design #46



Step 3

- | | |
|----|--------------|
| 13 | 1056
2231 |
|----|--------------|



Step 4

- | | | | | | |
|----|--------------|----|--------------|----|--------------|
| 14 | 1129
2569 | 18 | 1135
2234 | 22 | 1177
2457 |
| 15 | 1170
2402 | 19 | 1023
2561 | 23 | 1176
2595 |
| 16 | 1104
2547 | 20 | 1117
2276 | 24 | 0502
2398 |
| 17 | 1176
2595 | 21 | 1147
2263 | | |



Step 5

- | | |
|----|--------------|
| 25 | 1028
2206 |
|----|--------------|























design #45



Step 6

- | | |
|----|--------------|
| 26 | 1028
2206 |
|----|--------------|

Stitches: 25 025
 Height: 255 mm
 Width: 145 mm
 Thread Velvet™





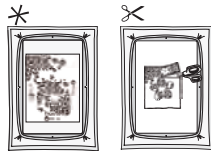



















- | | | |
|----|-------------------------------------------------------------------------------------|--------------|
| 1 |  | 1258
2473 |
| 2 |  | 1149
2593 |
| 3 |  | 1180
2572 |
| 4 |  | 1001
2343 |
| 5 |  | 1169
2249 |
| 6 |  | 1059
2576 |
| 7 |  | 1070
2557 |
| 8 |  | 1032
2288 |
| * |  | 1190
2611 |
| 9 |  | 1190
2611 |
| ✂ |  | 1190
2611 |
| 10 |  | 1190
2611 |
| 11 |  | 1119
2591 |
| * |  | 1190
2611 |
| 12 |  | 1190
2611 |
| ✂ |  | 1119
2591 |
| 13 |  | 1119
2591 |
| 14 |  | 1023
2561 |
| 15 |  | 1154
2412 |
| 16 |  | 1254
2286 |
| 17 |  | 1071
2574 |
| 18 |  | 1002
2574 |

Gütermann Sulky
 Robison - Anton



Stiches: 29 044
 Height: 249 mm
 Width: 187 mm





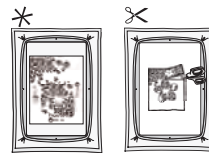









- 1  1165
2283
- *  1165
2283
- ✂  1165
2283
- 3  1165
2283
- 4  1001
2343
- *  1001
2343
- 5  1001
2343
- ✂  1001
2343
- 6  1001
2343
- *  1001
2343
- 7  1001
2343
- ✂  1001
2343
- 8  1001
2343
- *  1001
2343
- 9  1001
2343
- ✂  1001
2343
- 10  1001
2343
- 11  1023
2560
- 12  1025
2400
- 13  1321
2241
- 14  1216
2205
- 15  1056
2569
- 16  1129
2372
- 17  1001
2343
- 18  1218
2485



Gütermann Sulky
 Robison - Anton

78

Stitches: 19 232
Height: 251 mm
Width: 160 mm

- 1  1021
2289
- * 2  1021
2289
- ✂ 3  1021
2289
- 4  1239
2394
- 5  1129
2372
- 6  1170
2402
- 7  1177
2457
- 8  1156
2545
- 9  1175
2392
- 10  1032
2288
- 11  1235
2428
- 12  1001
2343

Gütermann Sulky
Robison - Anton

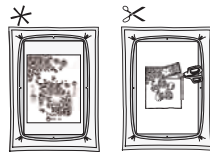



Stiches: 9 398
 Height: 198 mm
 Width: 137 mm

79

1 ■ 1211
 2317

Gütermann Sulky
 Robison - Anton



Stiches: 16 515
 Height: 177 mm
 Width: 88 mm





80

- 1 ■ 1111
2285
- 2 ■ 1254
2286
- 3 ■ 1212
2729
- 4 ■ 1297
2265
- 5 ■ 1167
2234
- 6 ■ 1080
2588
- 7 ■ 1031
2340
- 8 ■ 1193
2482
- 9 ■ 1111
2285

Gütermann Sulky
 Robison - Anton

81

Stitches: 6 025
 Height: 175 mm
 Width: 108 mm

- 1  1165
2283
- 2  1327
2539
- 3  1002
2574
- 4  1120
2582

Gütermann Sulky
 Robison - Anton

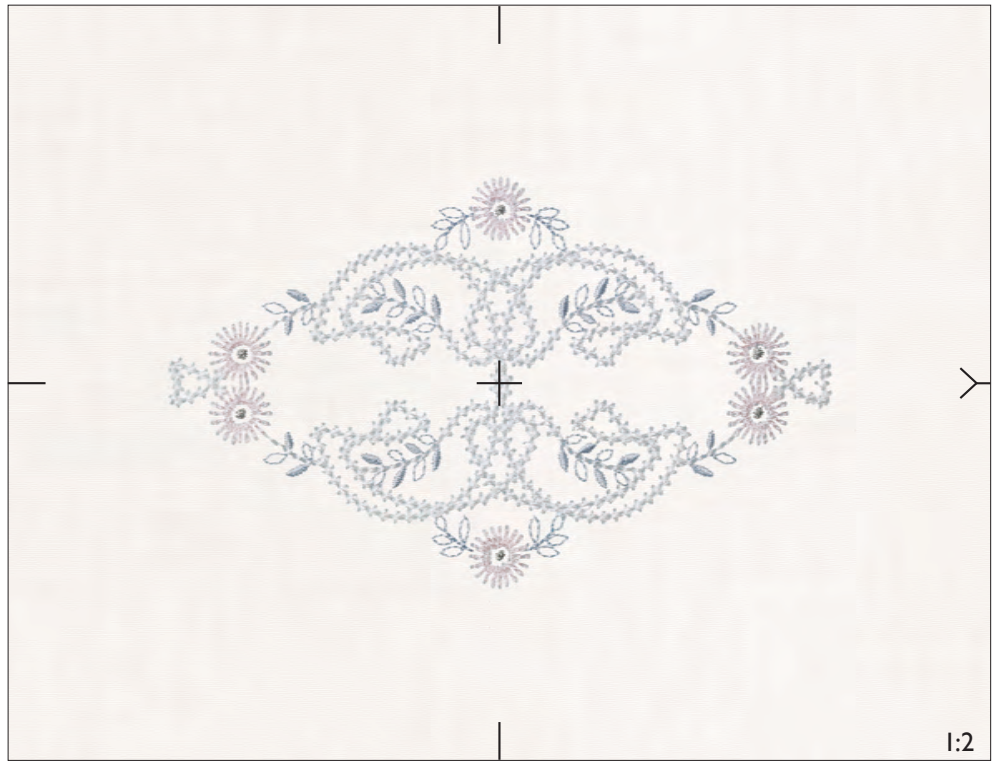















156 Sensational Needle Effects, design #8

For wing needle embroideries
 deactivate deLuxe™ Stitch
 System icon in Machine Settings
 menu.



82

Stitches: 22 839
 Height: 232 mm
 Width: 63 mm

- 1  1070
2557
 - 2  1017
2413
 - 3  1115
2223
 - 4  1061
2316
 - 5  1220
2217
 - 6  1111
2285
 - 7  1201
2239
 - 8  1145
2269
 - 9  1064
2501
 - 10  1205
2624
 - 11  1204
2238
 - 12  1145
2269
 - 13  1193
2482
 - 14  1001
2343
 - 15  1217
2610
 - 16  1193
2482
 - 17  1255
2628
- Gütermann Sulky
 Robison - Anton

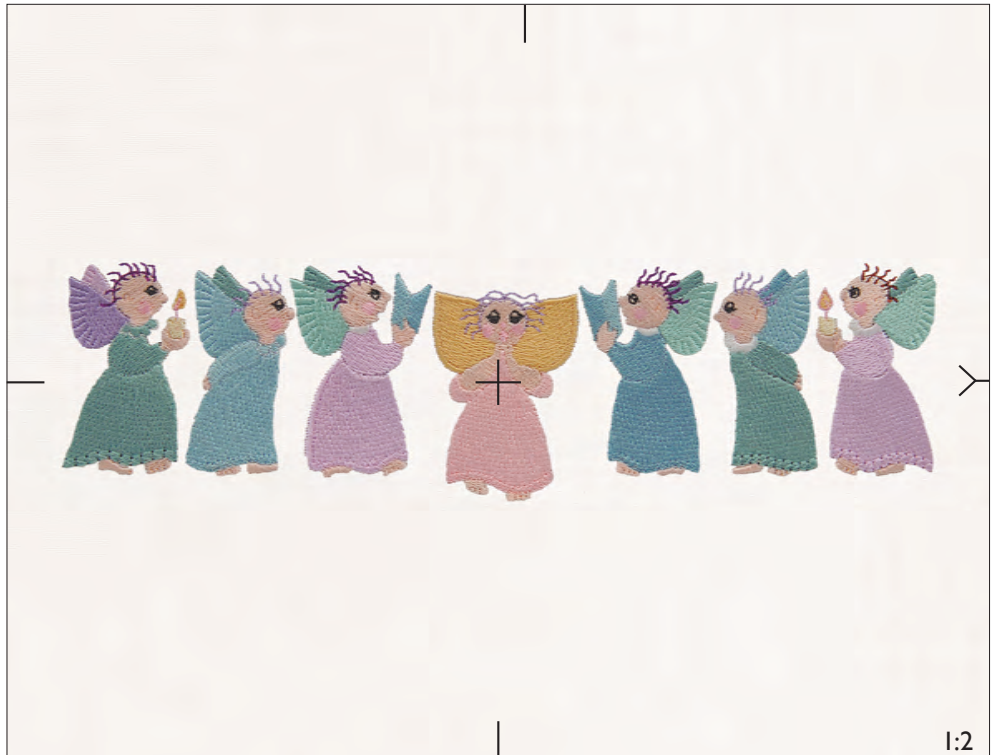

1:2

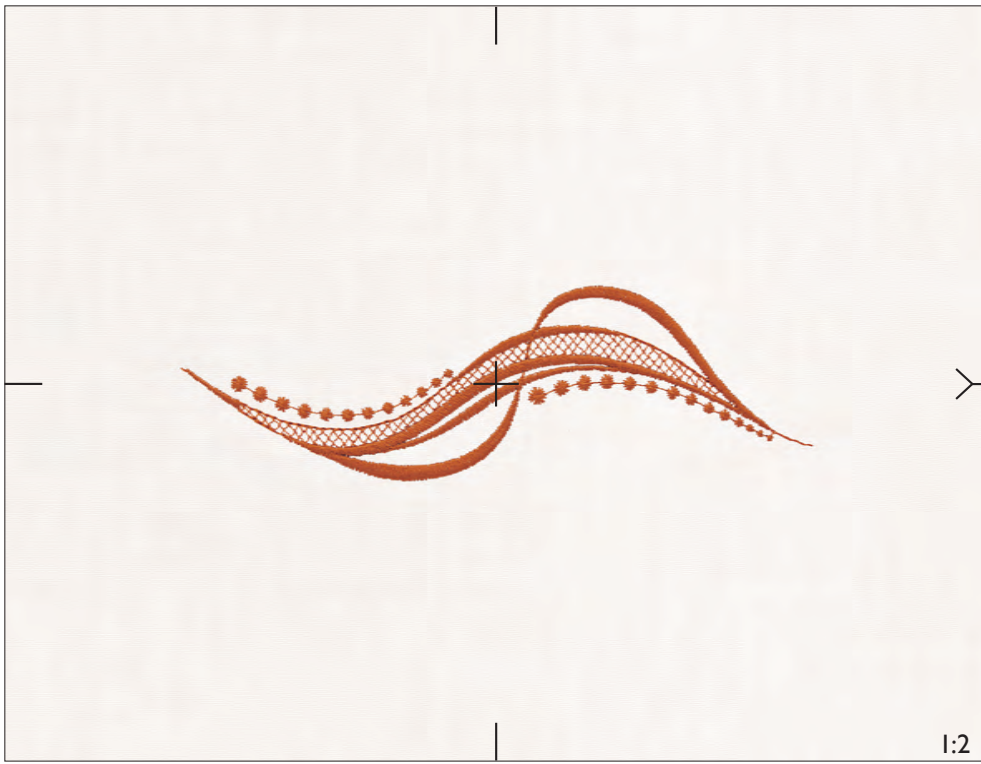

1:2

Stitches: 3 287
 Height: 168 mm
 Width: 53 mm

83

1  1021
 2289

Gütermann Sulky
 Robison - Anton

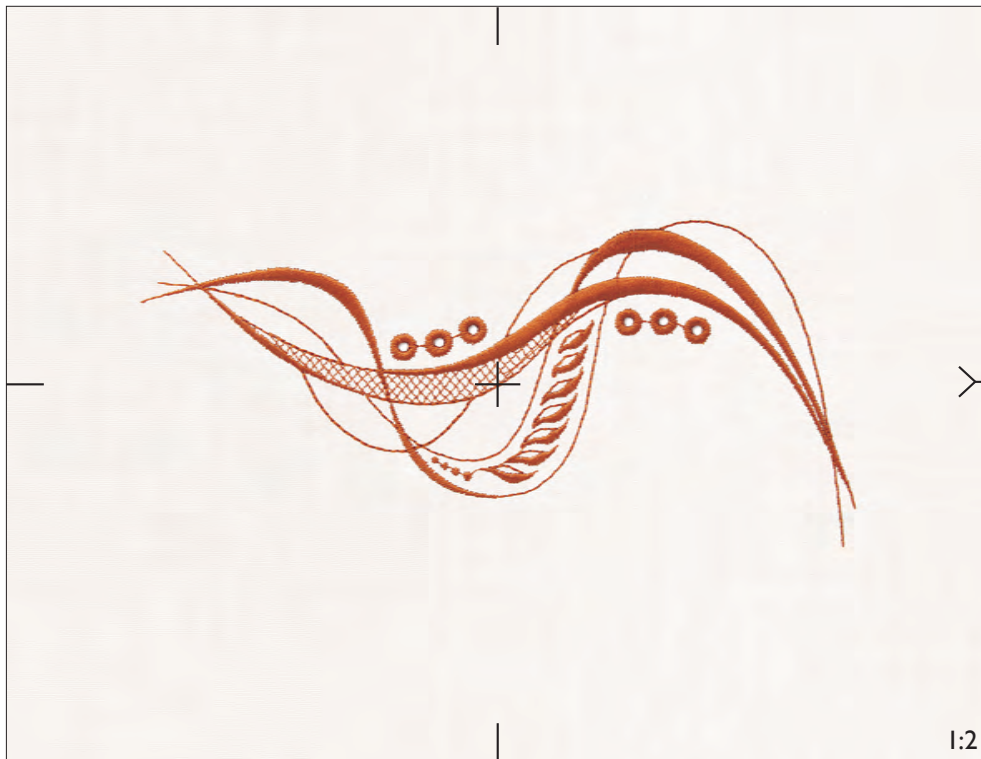



1:2



Stitches: 4 956
 Height: 193 mm
 Width: 87 mm

84

1  1021
 2289
 2  1021
 2289

Gütermann Sulky
 Robison - Anton

Stitches: 75 324
 Height: 341 mm
 Width: 195 mm
 Thread Velve™

- 1 1206
2521
- 2 1120
2582
- 3 1121
2599
- 4 1238
2409
- 5 1222
2239
- 6 1104
2547
- 7 1224
2237
- 8 1206
2521
- 9 1134
2433
- 10 1231
2261
- 11 1039
2508

Gütermann Sulky
 Robison - Anton



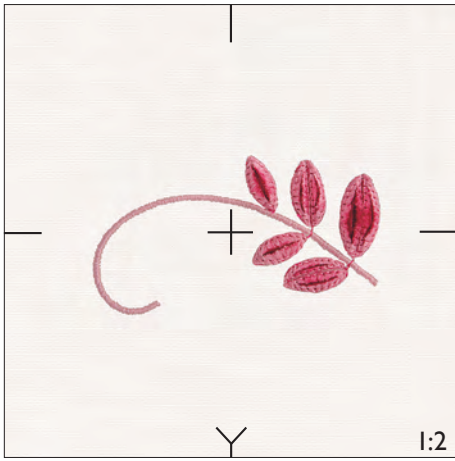

86

Stitches: 4 395
 Height: 41 mm
 Width: 77 mm
 Thread Velvet™

- 1 1121
2599
- 2 1231
2261
- 3 1224
2237

Gütermann Sulky
 Robison - Anton

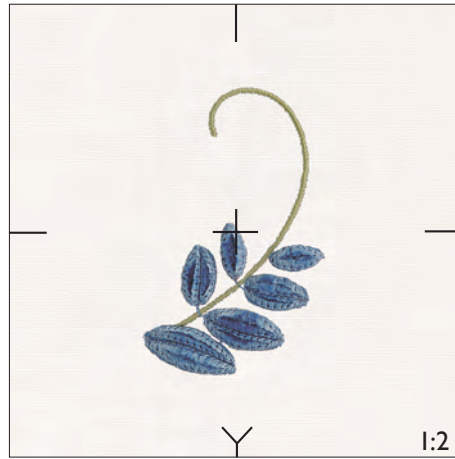

87

Stitches: 5 654
 Height: 77 mm
 Width: 48 mm
 Thread Velvet™

- 1 1104
2547
- 2 1134
2433
- 3 1222
2239

Gütermann Sulky
 Robison - Anton

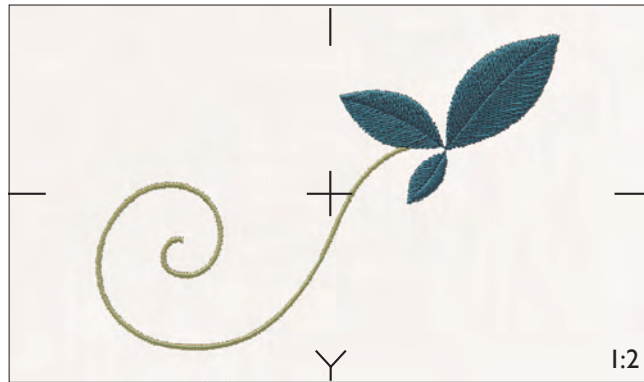

88

Stitches: 3 174
 Height: 84 mm
 Width: 122 mm

- 1 1104
2547
- 2 1206
2521

Gütermann Sulky
 Robison - Anton

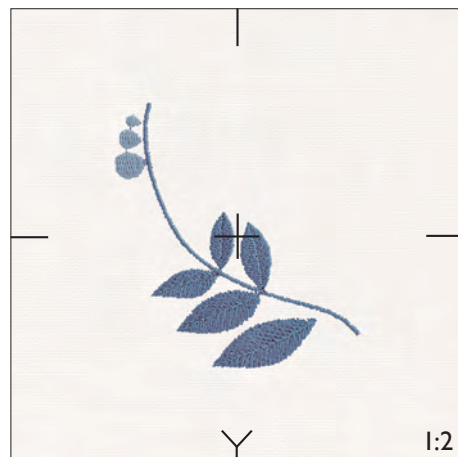

89

Stitches: 2 318
 Height: 71 mm
 Width: 64 mm

- 1 1222
2239
- 2 1134
2433

Gütermann Sulky
 Robison - Anton

90

Stitches: 3 897
Height: 69 mm
Width: 71 mm

- 1 1222
2239
- 2 1104
2547

Gütermann Sulky
Robison - Anton

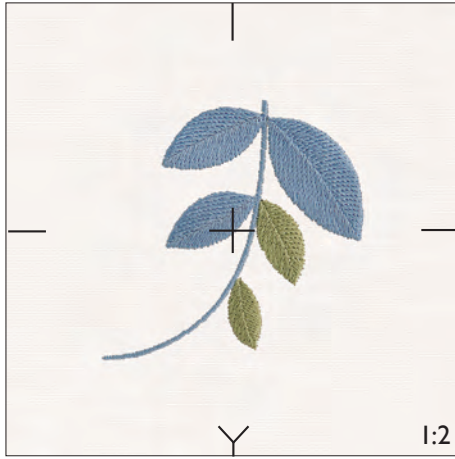

91

Stitches: 2 257
Height: 84 mm
Width: 60 mm

- 1 1238
2409
- 2 1104
2547

Gütermann Sulky
Robison - Anton

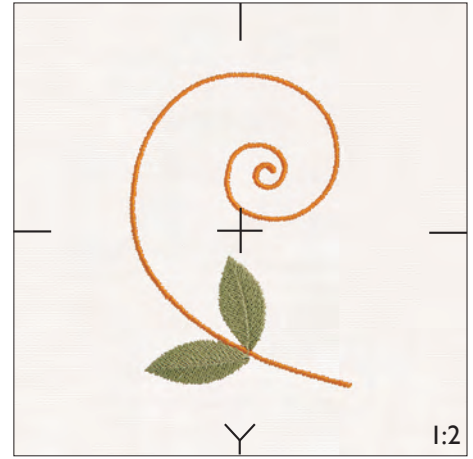

92

Stitches: 2 485
Height: 47 mm
Width: 97 mm

- 1 1224
2237
- 2
- 3 1039
2508

Gütermann Sulky
Robison - Anton

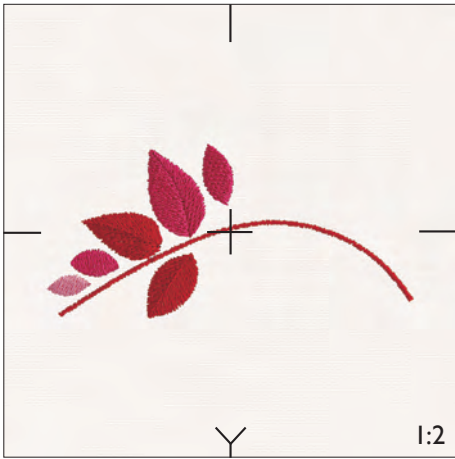

93

Stitches: 1 388
Height: 69 mm
Width: 48 mm

- 1 1206
2521

Gütermann Sulky
Robison - Anton

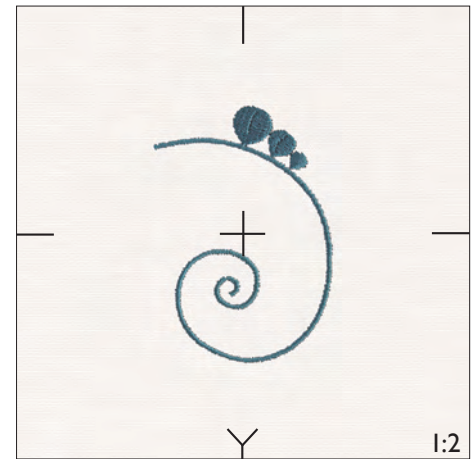

94

Stitches: 1 789
Height: 24 mm
Width: 24 mm
Thread Velvet™

- 1 1224
2237
- 2 1120
2582

Gütermann Sulky
Robison - Anton

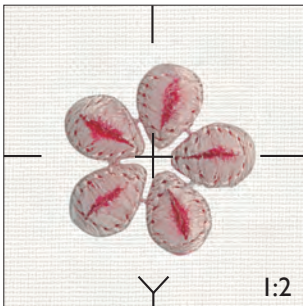



Stitches: 1 169
 Height: 34 mm
 Width: 20 mm
 Thread Velvet™

95

- 1 1223
2525
- 2 1028
2206
- 3 1028
2206

Gütermann Sulky
 Robison - Anton

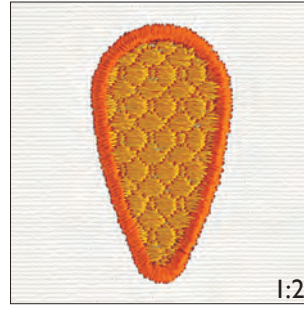

Stitches: 1 679
 Height: 35 mm
 Width: 19 mm

96

- 1 1137
2331
- 2 1168
2328

Gütermann Sulky
 Robison - Anton

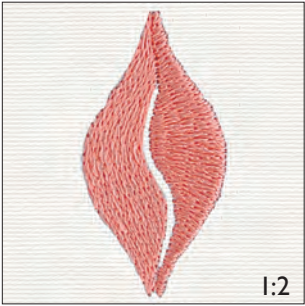

Stitches: 906
 Height: 38 mm
 Width: 19 mm

97

- 1 1016
2374

Gütermann Sulky
 Robison - Anton

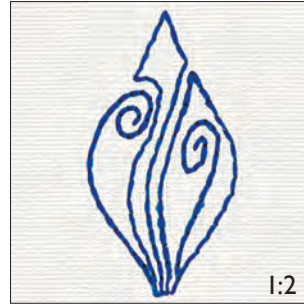

Stitches: 411
 Height: 38 mm
 Width: 19 mm

98

- 1 1535
2280

Gütermann Sulky
 Robison - Anton



Stitches: 929
 Height: 38 mm
 Width: 19 mm

99

- 1 1074
2300
- 2 1029
2433

Gütermann Sulky
 Robison - Anton



Stitches: 128
 Height: 11 mm
 Width: 11 mm

100

- 1 1185
2466

Gütermann Sulky
 Robison - Anton

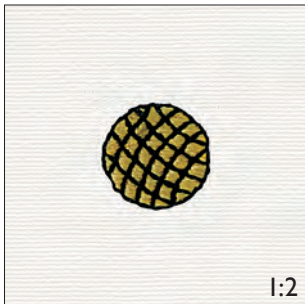

Stitches: 577
 Height: 14 mm
 Width: 15 mm

101

- 1 1167
2234
- 2 1234
2296

Gütermann Sulky
 Robison - Anton

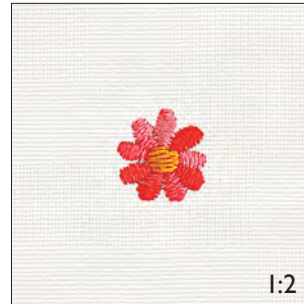

Stitches: 269
 Height: 12 mm
 Width: 12 mm



102

- 1 2102
2262
- 2 1137
2331

Gütermann Sulky
 Robison - Anton

103

Stitches: 482
Height: 27 mm
Width: 16 mm

- 1  1076
2528
- 2  1032
2288
- 3  1076
2528

Gütermann Sulky
Robison - Anton



154 Elegant Elements, design #69

104

Stitches: 340
Height: 17 mm
Width: 18 mm

- 1  1076
2528
- Gütermann Sulky
Robison - Anton



154 Elegant Elements, design #73

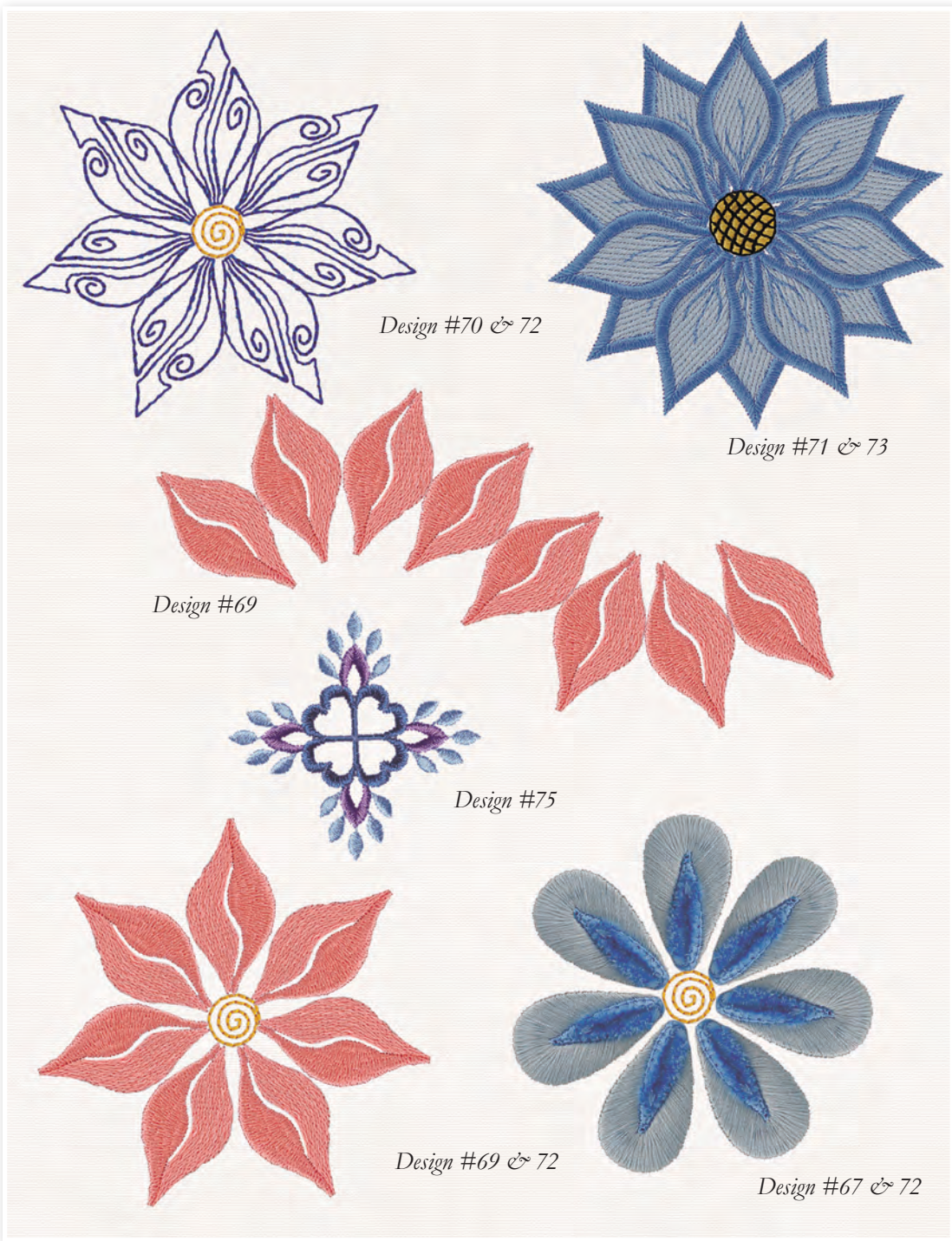

Stiches: 687
Höhe: 80 mm
Width: 80 mm



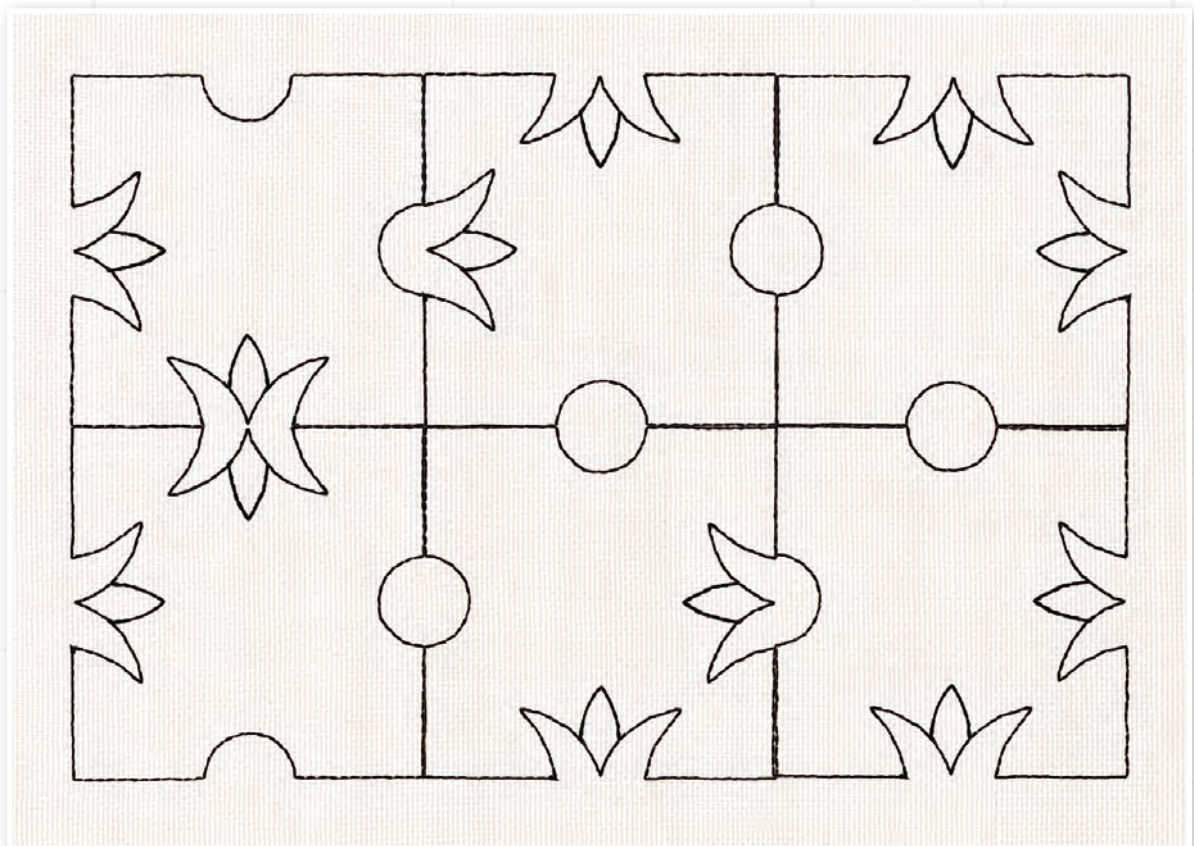
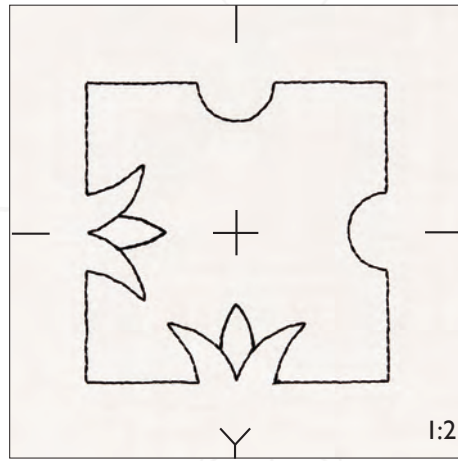

1 ■ 1005
2296

Gütermann Sulky
Robison - Anton



106

Stitches: 4 824
Height: 50 mm
Width: 51 mm

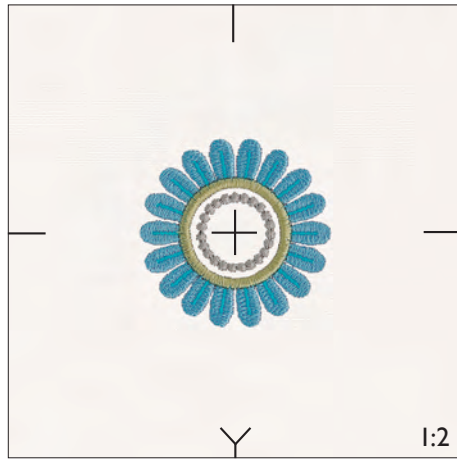

- 1  1011
2618
- 2  1248
2239
- 3  1096
2446
- 4  1104
2547

Gütermann Sulky
Robison - Anton



107

Stitches: 2 772
Height: 41 mm
Width: 47 mm

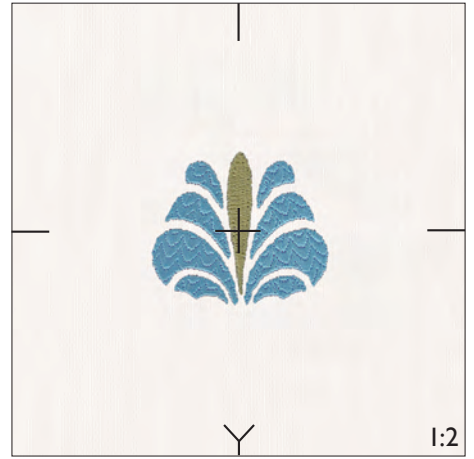

- 1  1104
2547
- 2  1248
2239

Gütermann Sulky
Robison - Anton



108

Stitches: 3 789
Height: 63 mm
Width: 44 mm





- 1  1104
2547
- 2  1248
2239
- 3  1011
2618

Gütermann Sulky
Robison - Anton



109

Stitches: 2 907
Height: 43 mm
Width: 86 mm

- 1  1104
2547
- 2  1011
2618
- 3  1248
2239
- 4  1104
2547

Gütermann Sulky
Robison - Anton

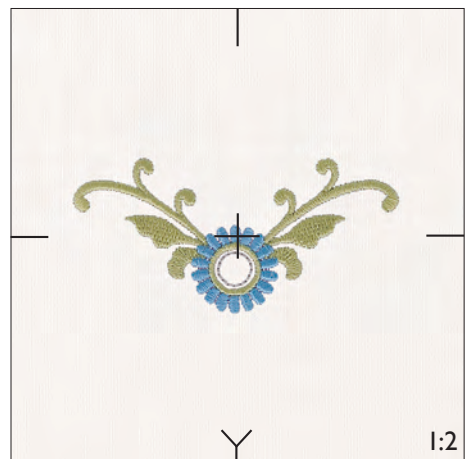

110

Stitches: 1 048
Height: 40 mm
Width: 33 mm

- 1  1104
2547

Gütermann Sulky
Robison - Anton

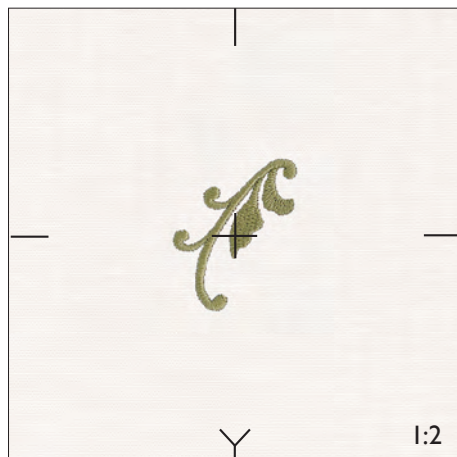

111

Stitches: 621
Height: 43 mm
Width: 27 mm

- 1  1104
2547

Gütermann Sulky
Robison - Anton

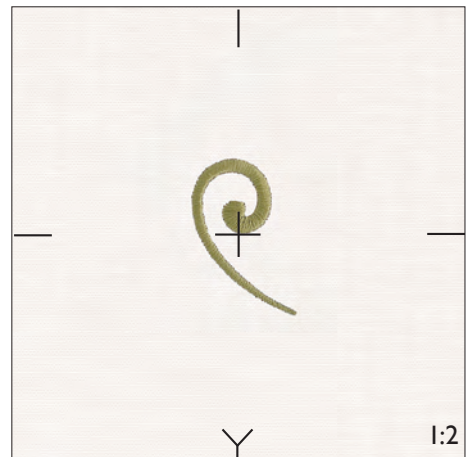

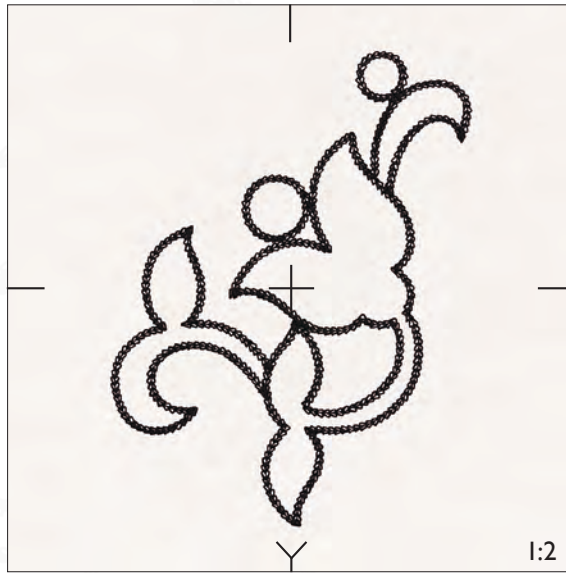

Stitches: 3 146
 Height: 127 mm
 Width: 96 mm

112



Gütermann Sulky
 Robison - Anton

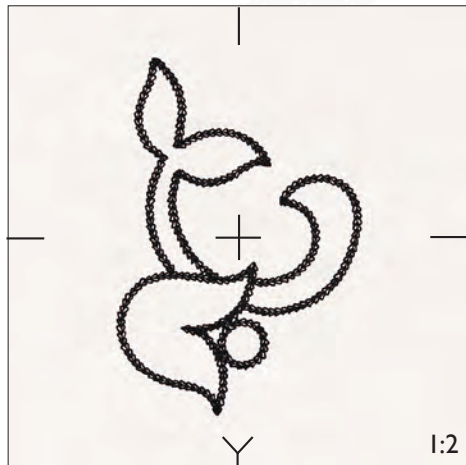

113

Stitches: 1 874
 Height: 96 mm
 Width: 66 mm



1 1234
 2296

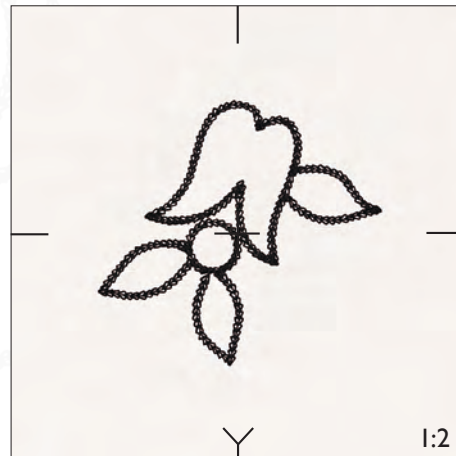

Stitches: 1 502
 Height: 71 mm
 Width: 77 mm

114



1 1234
 2296

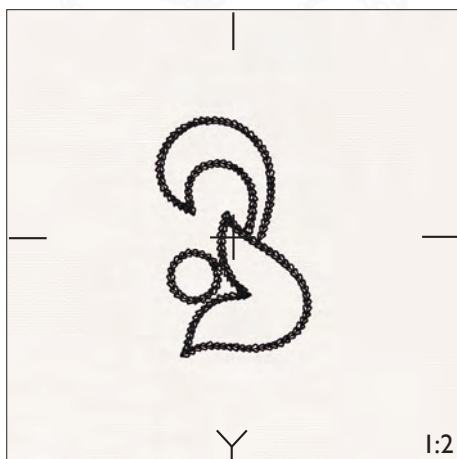

115

Stitches: 1 179
 Height: 64 mm
 Width: 41 mm



1 1234
 2296

Gütermann Sulky
 Robison - Anton

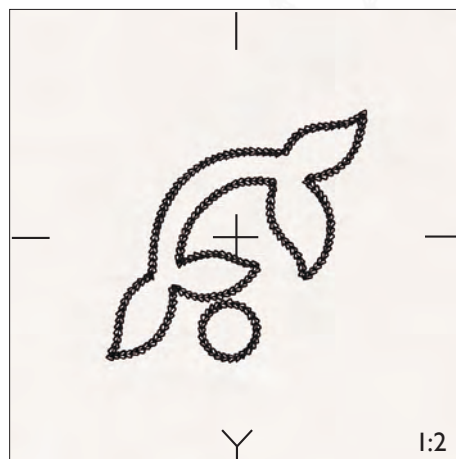

Stitches: 1 454
 Height: 68 mm
 Width: 70 mm



116



Gütermann Sulky
 Robison - Anton

117

Stiches: 20 678
Height: 237 mm
Width: 178 mm

- 1  1216
2205
- 2  1005
2296

Gütermann Sulky
Robison - Anton

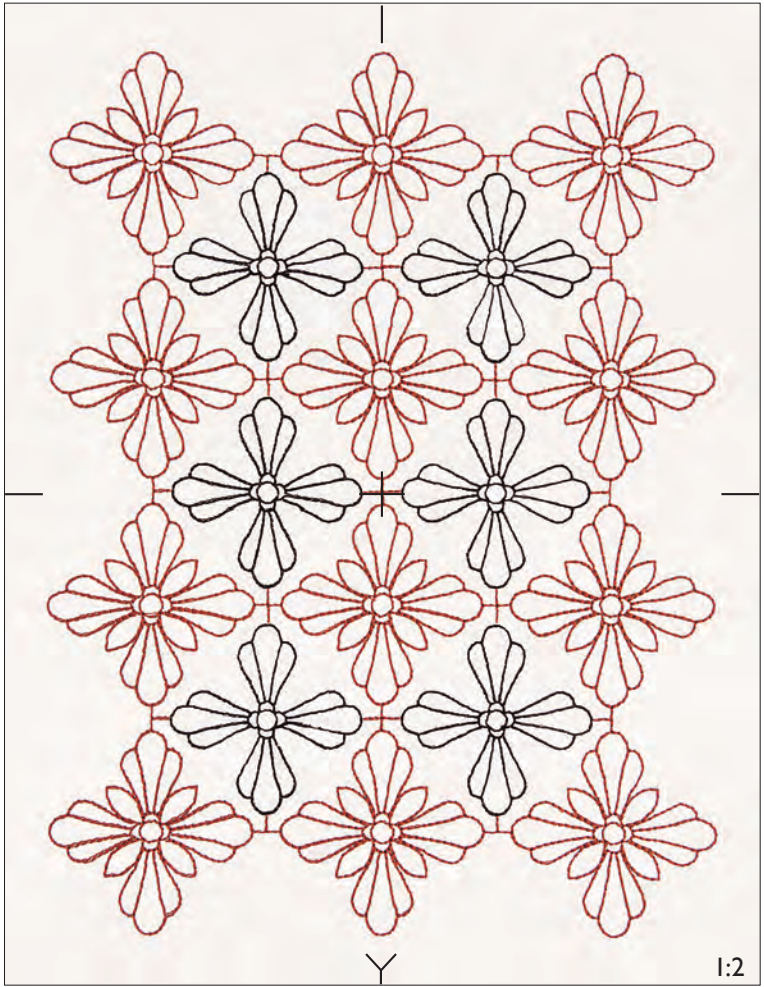

118

Stiches: 1 317
Height: 54 mm
Width: 54 mm

- 1  1216
2205

Gütermann Sulky
Robison - Anton

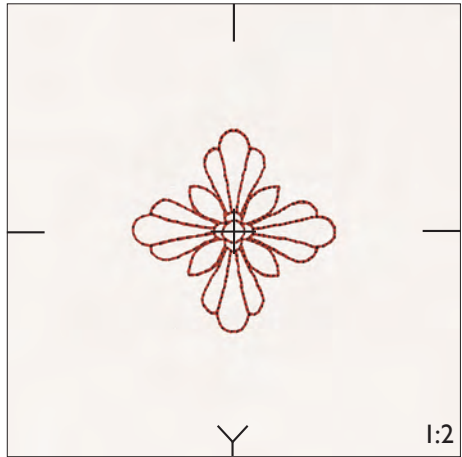

119

Stiches: 994
Height: 51 mm
Width: 51 mm

- 1  1005
2296

Gütermann Sulky
Robison - Anton

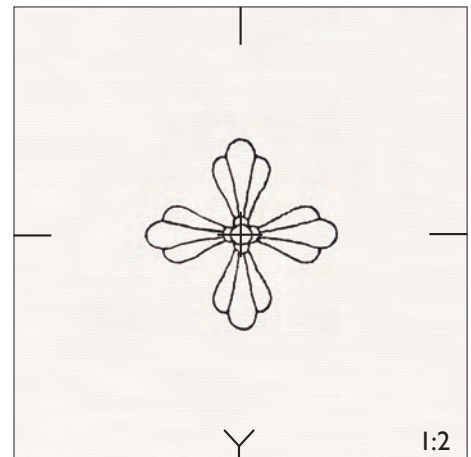



Stitches: 22 523
 Height: 207 mm
 Width: 189 mm

120

1 ■ 1202
 2534

Gütermann Sulky
 Robison - Anton

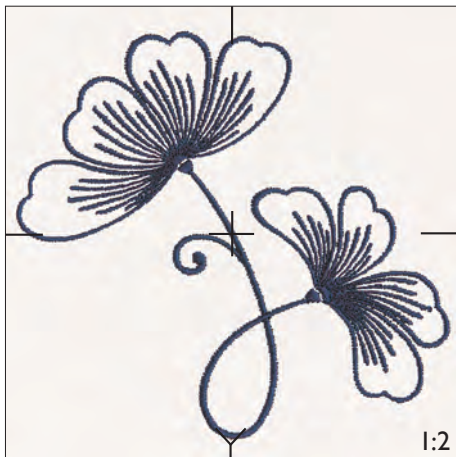

121

Stitches: 9 305
 Height: 109 mm
 Width: 115 mm

1 ■ 1202
 2534

Gütermann Sulky
 Robison - Anton

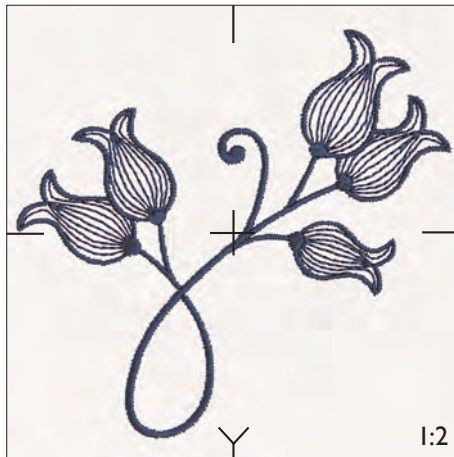

122

Stitches: 5 658
 Height: 109 mm
 Width: 115 mm

1 ■ 1202
 2534

Gütermann Sulky
 Robison - Anton

123 *Stiches: 15 061*
Height: 239 mm
Width: 188 mm

1 ■ 1169
2249

Gütermann Sulky
Robison - Anton

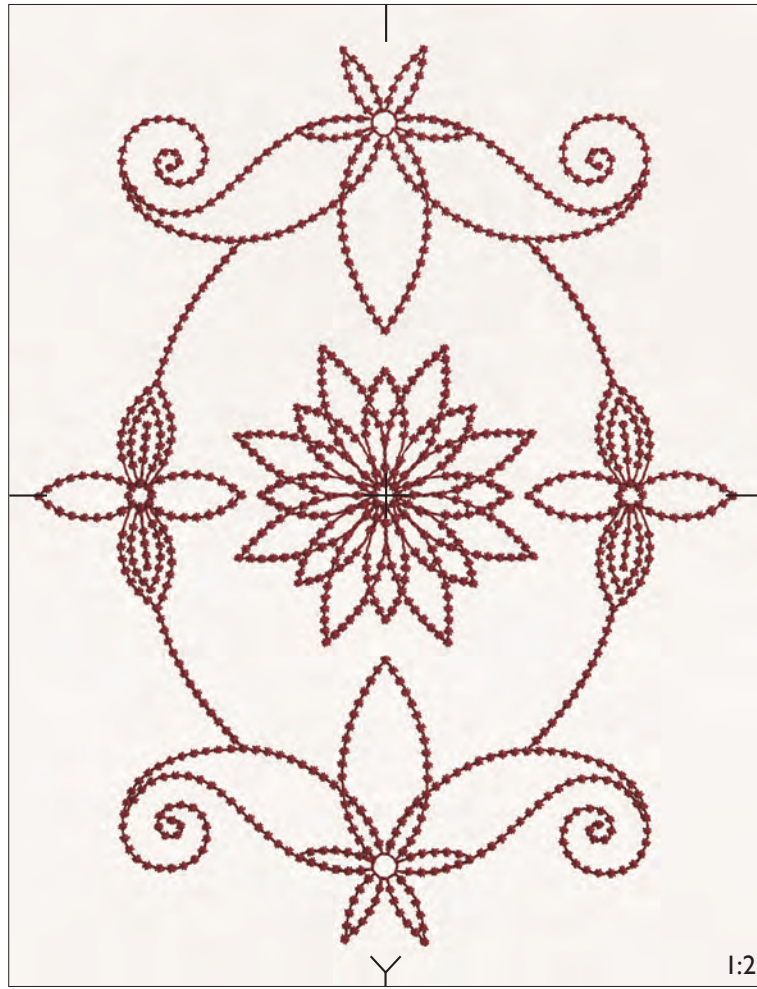

124 *Stiches: 6 377*
Height: 111 mm
Width: 111 mm

1 ■ 1169
2249

Gütermann Sulky
Robison - Anton

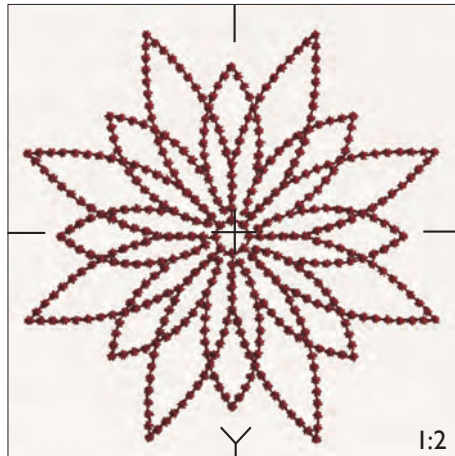

125

Stiches: 5 086
Height: 114 mm
Width: 114 mm

1 ■ 1169
2249

Gütermann Sulky
Robison - Anton

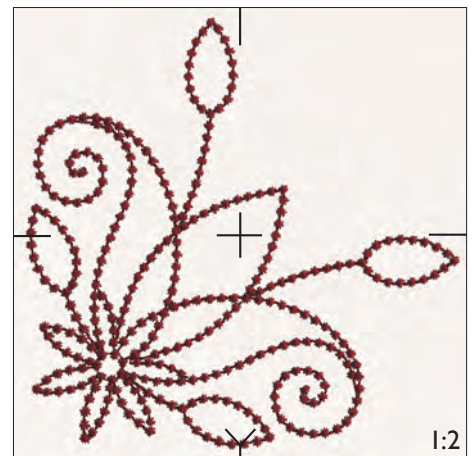

Stitches: 18 964
Height: 231 mm
Width: 118 mm

1  1327
2539

Gütermann Sulky
Robison - Anton

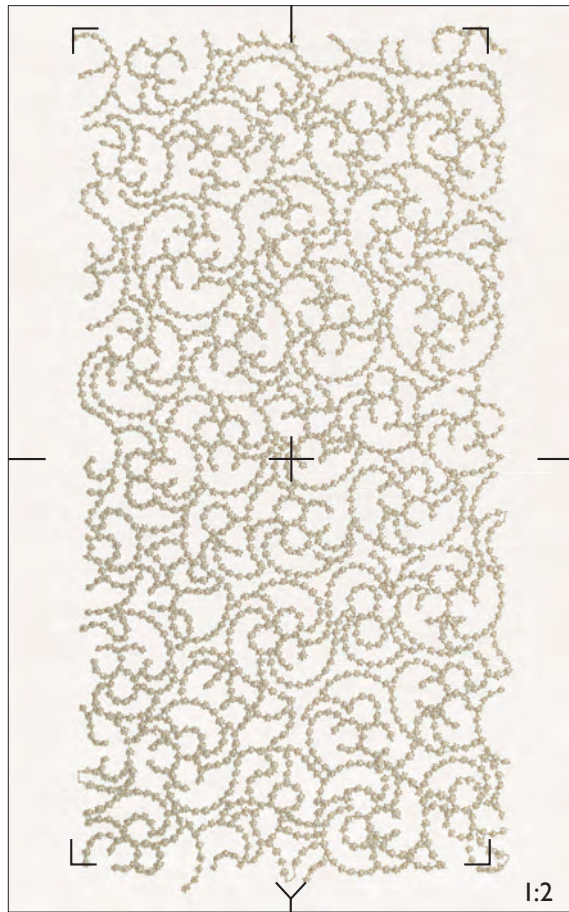

198 Candlewicking Creations, design #1



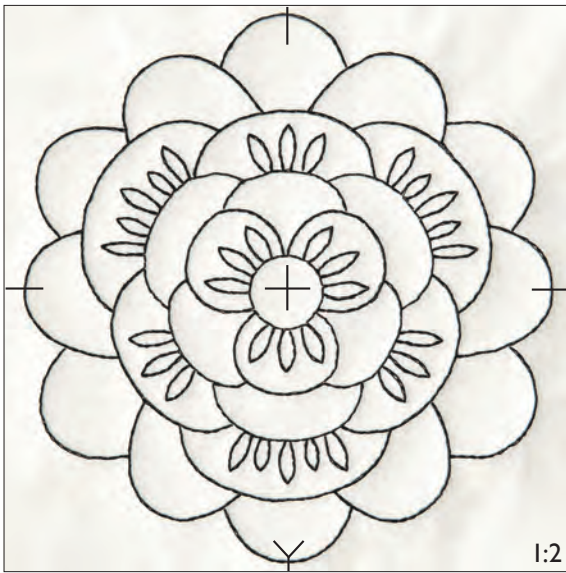

1:2

127

Stitches: 3 634
Height: 145 mm
Width: 139 mm

1 ■ 1234
2296

Gütermann Sulky
Robison - Anton

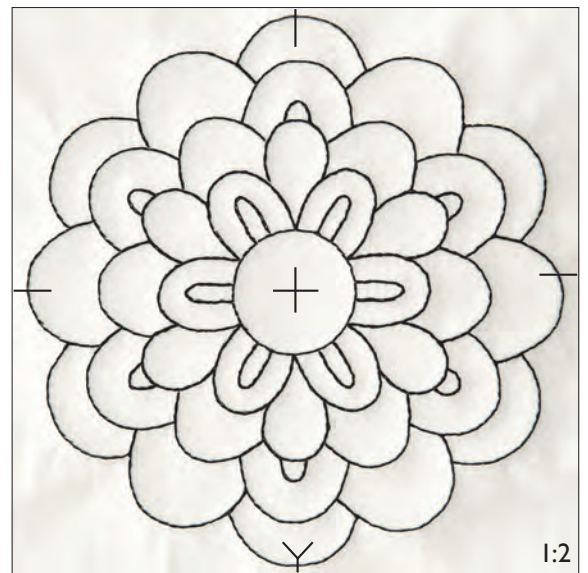

1:2

128

Stitches: 2 889
Height: 145 mm
Width: 141 mm

1 ■ 1234
2296

Gütermann Sulky
Robison - Anton

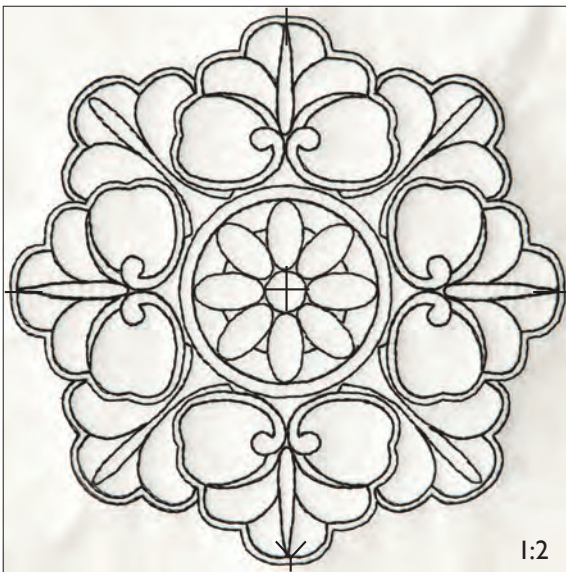

1:2

129

Stitches: 6 269
Height: 145 mm
Width: 145 mm

1 ■ 1234
2296

Gütermann Sulky
Robison - Anton

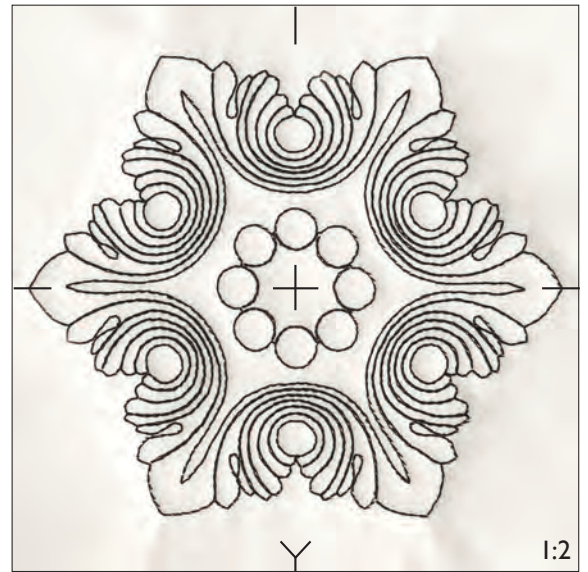

1:2

130

Stitches: 6 145
Height: 126 mm
Width: 145 mm

1 ■ 1234
2296

Gütermann Sulky
Robison - Anton

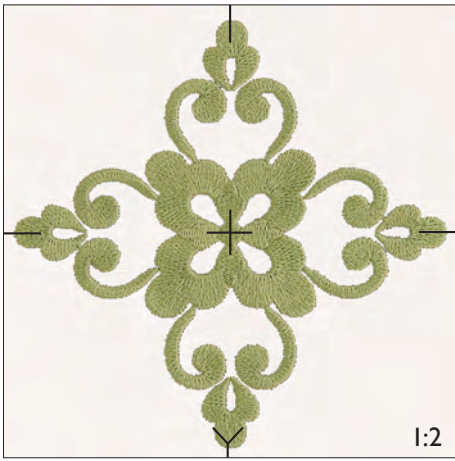

131

Stitches: 8 563
Height: 115 mm
Width: 115 mm

1  1104
2547

Gütermann Sulky
Robison - Anton

1:2

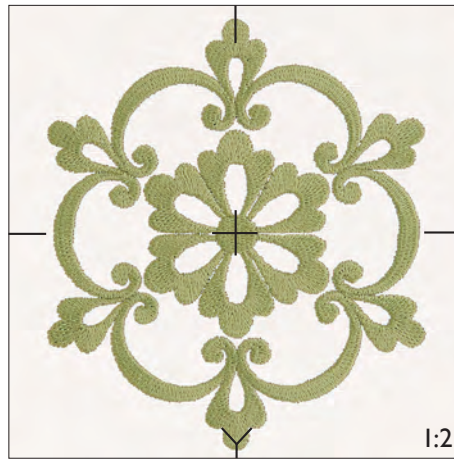

132

Stitches: 11 510
Height: 116 mm
Width: 102 mm

1  1104
2547

Gütermann Sulky
Robison - Anton

1:2

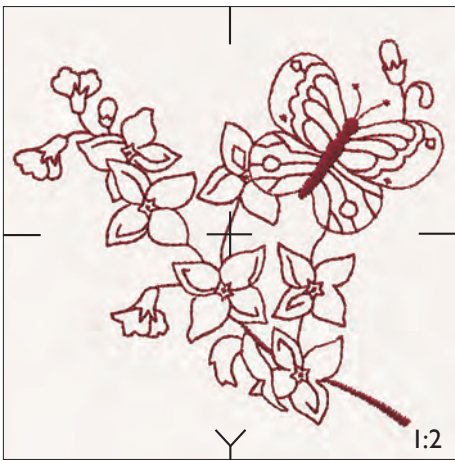

133

Stitches: 4 574
Height: 103 mm
Width: 114 mm

1  1169
2249

Gütermann Sulky
Robison - Anton

1:2

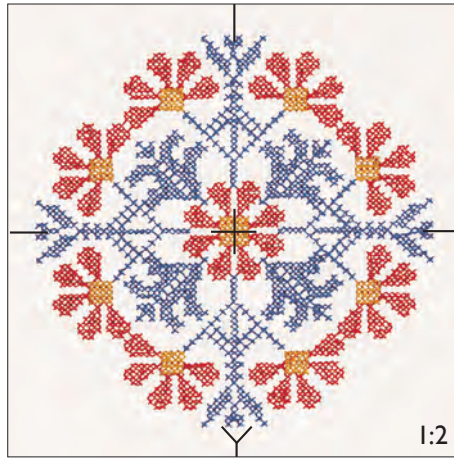

134

Stitches: 7 364
Height: 105 mm
Width: 105 mm

1  1076
2528

2  1039
2508

3  1185
2466

Gütermann Sulky
Robison - Anton

1:2

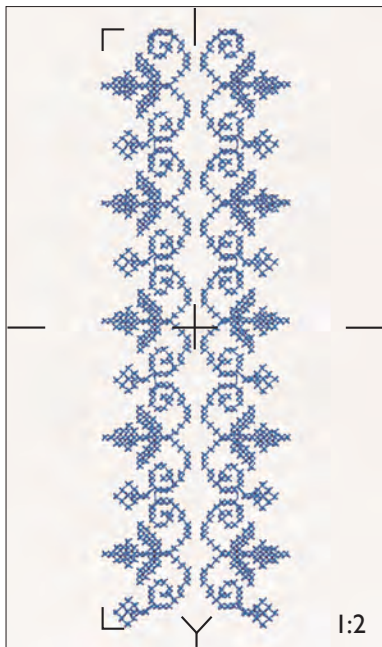

135

Stitches: 4 256
Height: 159 mm
Width: 50 mm

1  1076
2528

Gütermann Sulky
Robison - Anton

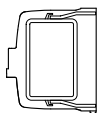

1:2

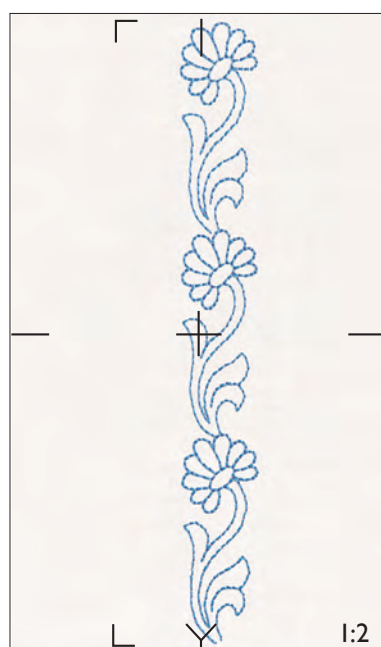

136

Stitches: 2 003
Height: 165 mm
Width: 30 mm

1  1028
2206

Gütermann Sulky
Robison - Anton

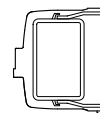

1:2

137

Stitches: 3 202
Height: 150 mm
Width: 18 mm

- 1 1104
2547
- 2 1248
2239
- * 1248
2239
- 3 1248
2239

Gütermann Sulky
Robison - Anton

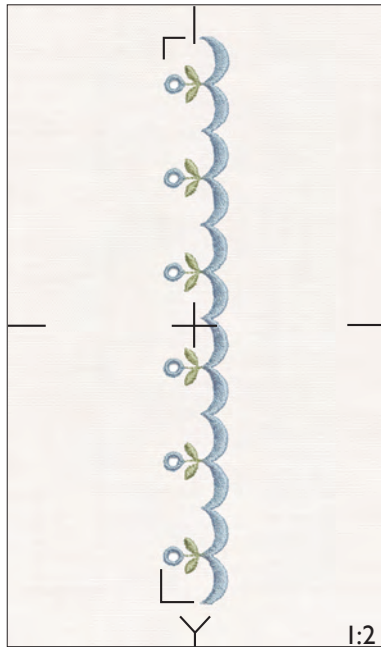
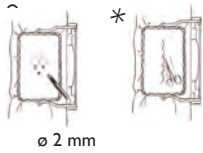

65 Delicate & Dainty, design #15

138

Stitches: 2 650
Height: 163 mm
Width: 22 mm

- 1 7001
1002

Gütermann Sulky
Robison - Anton

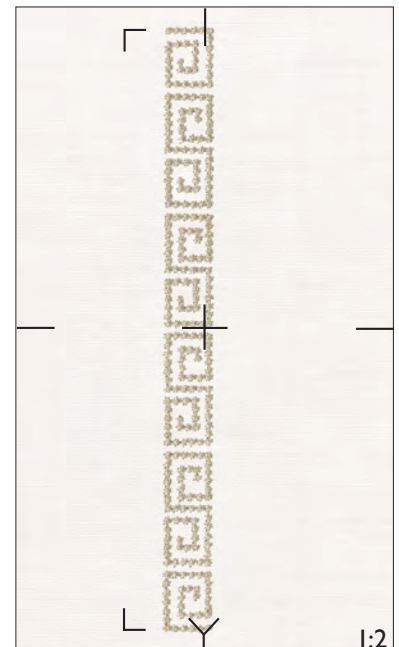
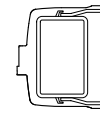

198 Candlewicking Creations, design #17

139

Stitches: 9 129
Height: 166 mm
Width: 12 mm

- 1 1263
2263
- 2 1117
2374
- 3 1238
2409

Gütermann Sulky
Robison - Anton

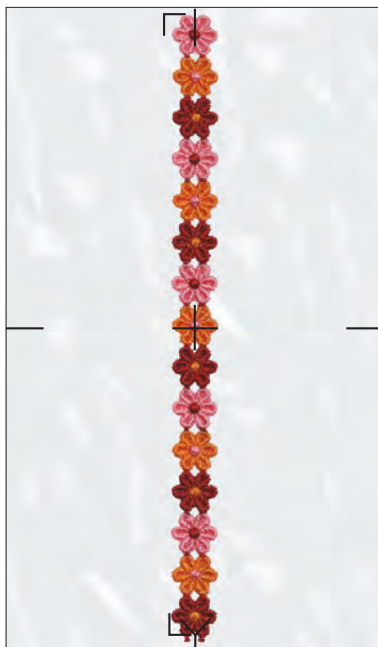

65 Delicate & Dainty, design #2



140

Stitches: 12 751
Height: 160 mm
Width: 39 mm

- 1 1017
2413
- Step 1
- 2 1017
2413
- Step 2
- 3 1017
2413

Gütermann Sulky
Robison - Anton

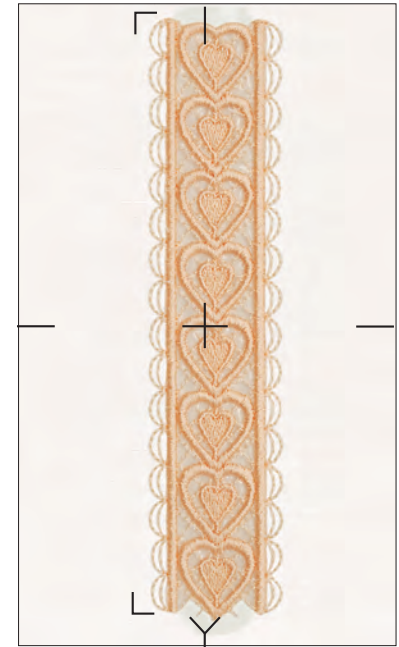

91 Endless Insertions & Thread Work, design #9

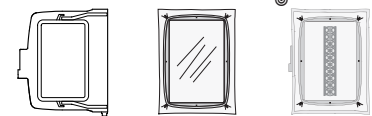



Stitches: 38 350
 Height: 237 mm
 Width: 145 mm

141

1 1258
 2473

Gütermann Sulky
 Robison - Anton

185 Lovely Lace on Tulle, design #1

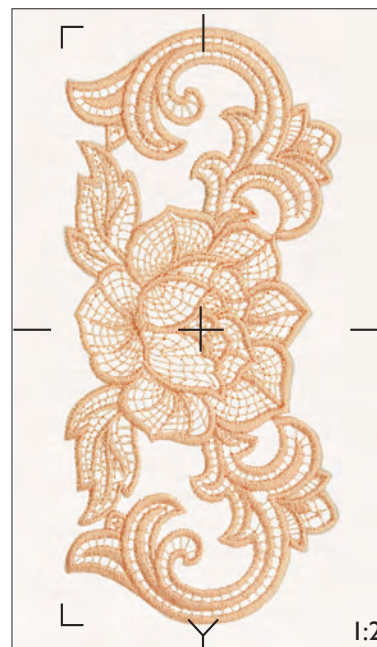

Stitches: 16 052
 Height: 158 mm
 Width: 74 mm

142

1 1258
 2473

Gütermann Sulky
 Robison - Anton

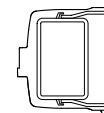

185 Lovely Lace on Tulle, design #2

143

Stiches: 45 068
Height: 234 mm
Width: 142 mm

1 1071
Cotton 30 wt
Gütermann Sulky

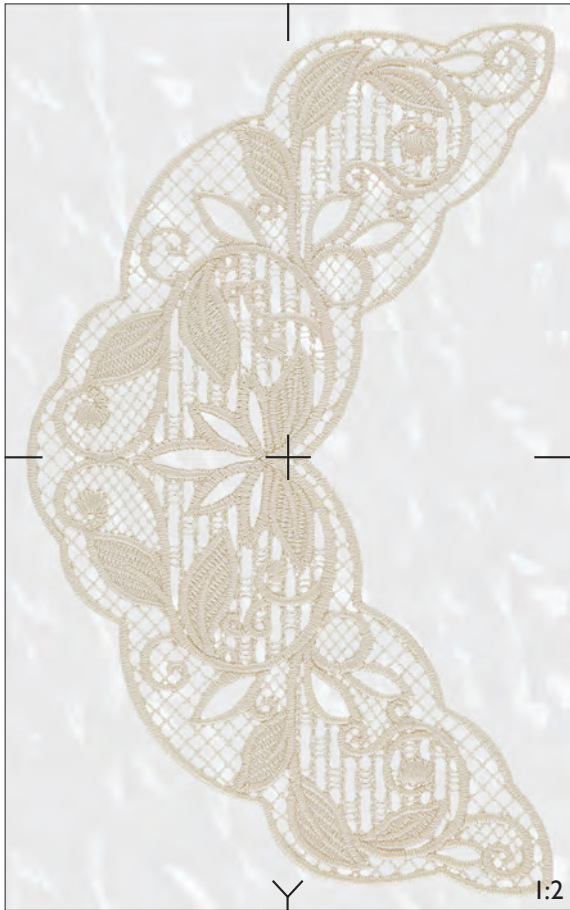

1:2

208 Endless Romantic Cotton Lace, design #1



144

Stiches: 21 403
Height: 136 mm
Width: 85 mm

1 1071
Cotton 30 wt
Gütermann Sulky

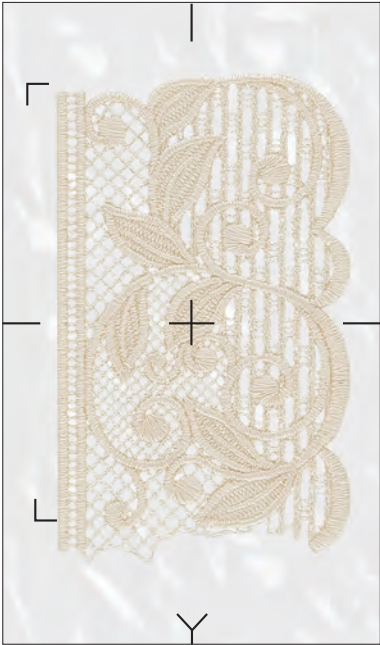

208 Endless Romantic Cotton Lace, design #16

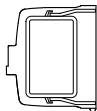



145

Stiches: 24 957
 Height: 95 mm
 Width: 94 mm

- 1 1082
2232
- 2 1082
2232

Gütermann Sulky
 Robison - Anton

89 Seasons in Lace Lace, design #7

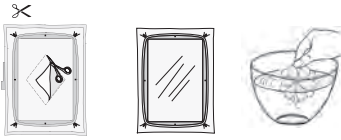

146

Stiches: 5 654
 Height: 77 mm
 Width: 48 mm

- 1 1082
2232
- 2 1082
2232

Gütermann Sulky
 Robison - Anton



89 Seasons in Lace Lace, design #14

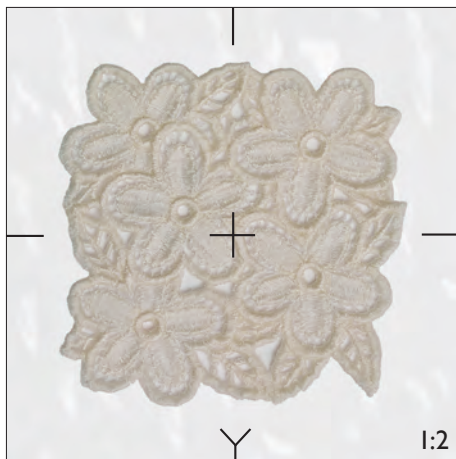

147

Stiches: 19 709
 Height: 93 mm
 Width: 96 mm

- 1 1071
2574

Gütermann Sulky
 Robison - Anton

166 Vintage Lace, design #15

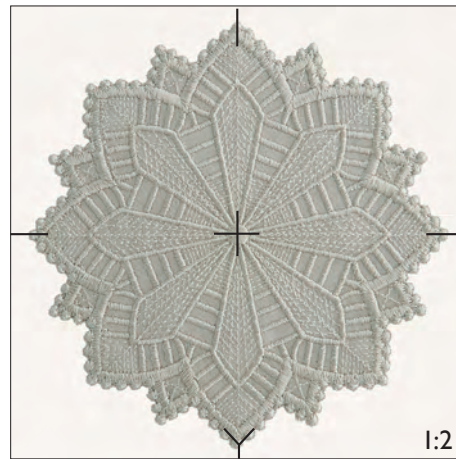

148

Stiches: 16 878
 Height: 109 mm
 Width: 109 mm

- 1 1236
2574
- * 1236
2574
- 2 1236
2574
- 3 1236
2574

Gütermann Sulky
 Robison - Anton

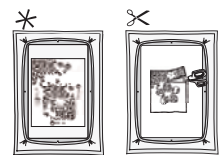

149

Stitches: 82 155
Height: 231 mm
Width: 145 mm

1 1111
2599

Gütermann Sulky
Robison - Anton

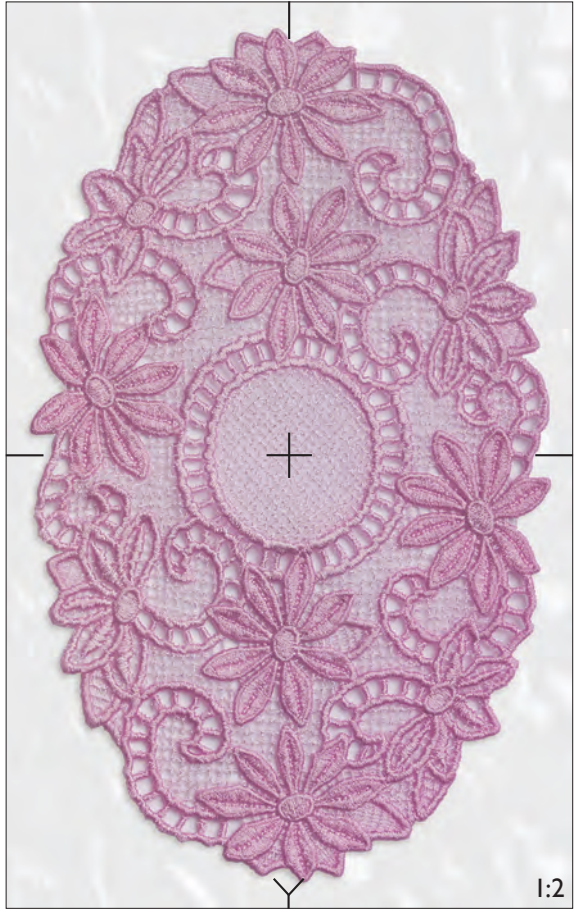

166 Vintage Lace, design #2



150

Stitches: 12 843
Height: 87 mm
Width: 87 mm

1 1190
Cotton 30 wt

Gütermann Sulky

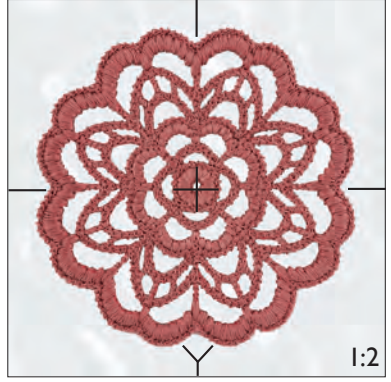

217 Precious Crochet, design #1



151

Stitches: 17 183
Height: 94 mm
Width: 94 mm

1 1190
Cotton 30 wt

Gütermann Sulky

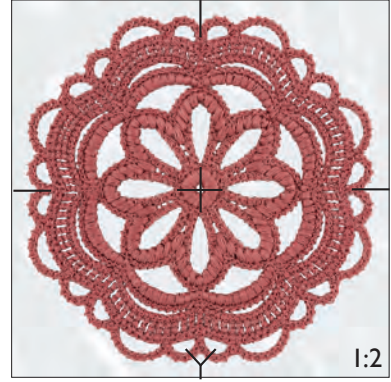

217 Precious Crochet, design #2



152

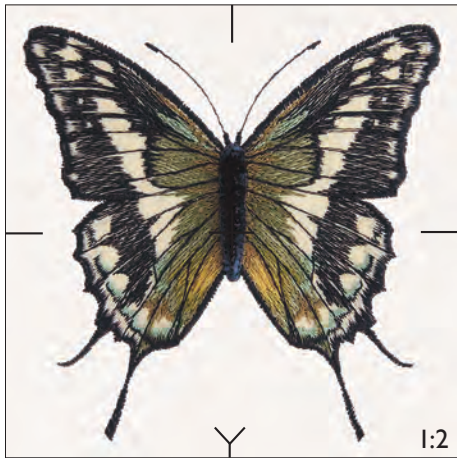

Stitches: 12 676
 Height: 111 mm
 Width: 112 mm
 Thread Velvet™

- 1 1001
2539
- * 1001
2539
- 2 1001
2539
- 3 1001
2539
- 4 1135
2586
- 5 1173
2317
- 6 1207
2278
- 7 1056
2477
- 8 1182
2387
- 9 1294
2341

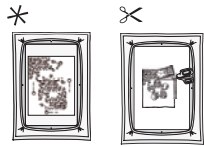

✂ Thread Velvet™

Gütermann Sulky
 Robison - Anton

203 Special Techniques Butterflies, design #2



153



Stitches: 16 691
 Height: 86 mm
 Width: 118 mm
 Thread Velvet™

- 1 1001
2539
- * 1001
2539
- 2 1001
2539
- 3 1001
2539
- 4 1061
2264
- 5 1074
2300
- 6 0621
2205
- 7 1247
2372
- 8 1131
2337
- 9 1247
2372

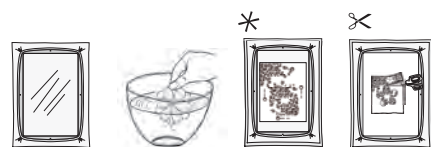

Gütermann Sulky
 Robison - Anton

203 Special Techniques Butterflies, design #6

154



Stitches: 31 656
 Height: 175 mm
 Width: 110 mm
 Thread Velvet™





- 1 7007
1000
- 2 1131
2566
- 3 7005
1001
- 4 1264
2339
- 5 7010
1004
- 6 1035
2622
- 7 0621
2581
- 8 1158
2569
- 9 0568
2289
- 10 1247
2372
- 11 1057
2251
- 12 1131
2566

Gütermann Sulky
 Robison - Anton

191 Thread Velvet, design #1

155

Stitches: 11 292
 Height: 166 mm
 Width: 80 mm

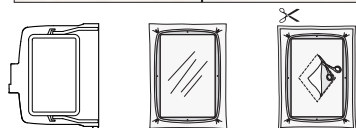
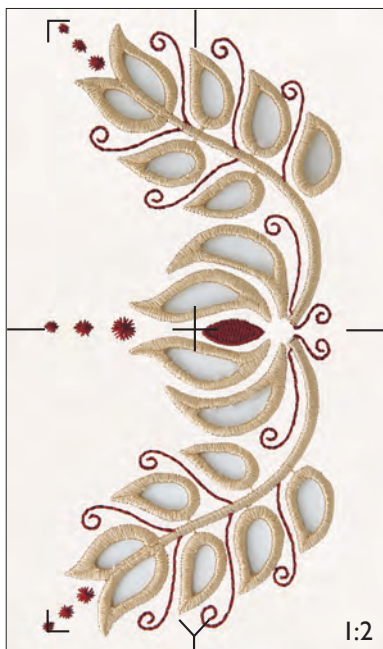

- 1  1169
2249
- 2  1127
2476
- 3  1127
2476
- 4  1127
2476
- 5  1127
2476

Gütermann Sulky
 Robison - Anton



156

Stitches: 9 723
 Height: 231 mm
 Width: 145 mm

- 1  7003
1000
- 2  1229
2241
- 3  sewing thread

Gütermann Sulky
 Robison - Anton

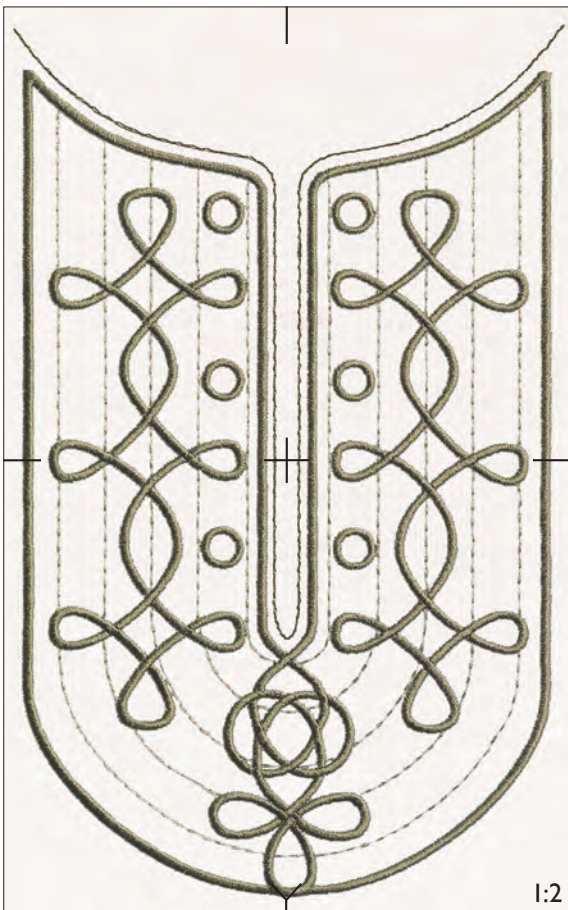



173 All Around the Edge, design #8



157

Stitches: 27 033
Height: 253 mm
Width: 165 mm

- 1  1275
2555
- 2  1275
2555

Gütermann Sulky
Robison - Anton

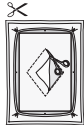
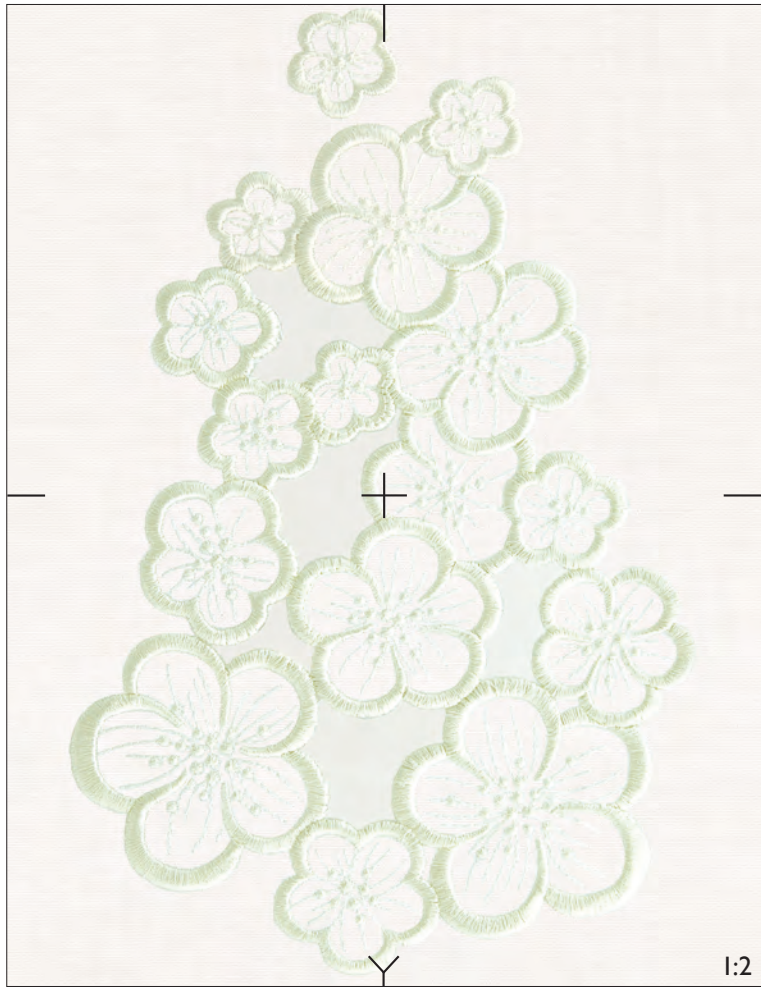





202 Cutwork Finesse, design #3



Stitches: 58 260
 Height: 339 mm
 Width: 194 mm



- 1  1275
2555
- ✂ 2  1275
2555
- ✂ 3  1275
2555
- ✂ 4  1275
2555
- ✂ 5  1275
2555

Gütermann Sulky
 Robison - Anton

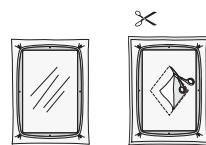

202 Cutwork Finesse, design #18

159

Stitches: 17 903
Height: 231 mm
Width: 146 mm

- 1 1234
Cotton 30 wt
- 2 1195
Cotton 30 wt
- 3 1032
Cotton 30 wt
- 4 1031
Cotton 30 wt

Gütermann Sulky

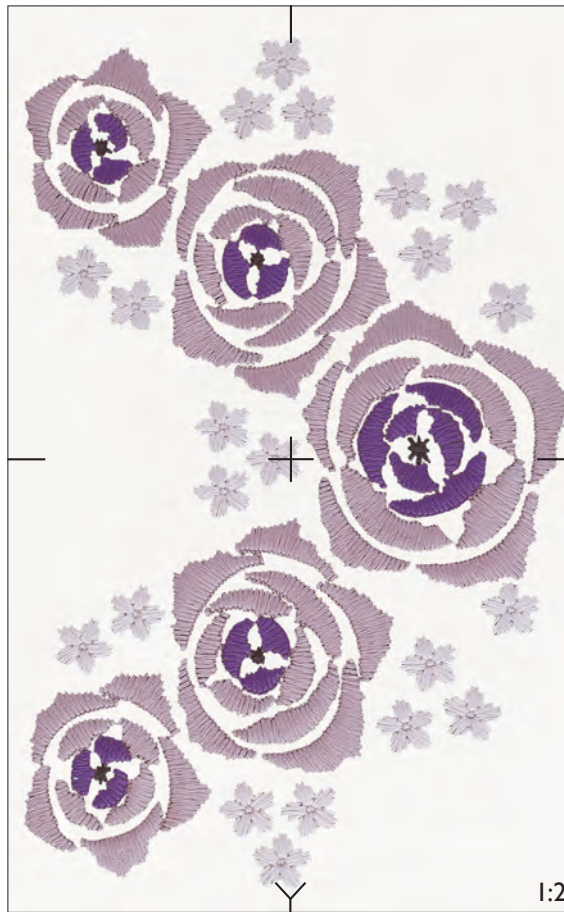

210 Handlook Needlework, design #3

160

Stitches: 8 271
Height: 145 mm
Width: 91 mm

- 1 1234
Cotton 30 wt
- 2 1195
Cotton 30 wt
- 3 1032
Cotton 30 wt
- 4 1031
Cotton 30 wt

Gütermann Sulky

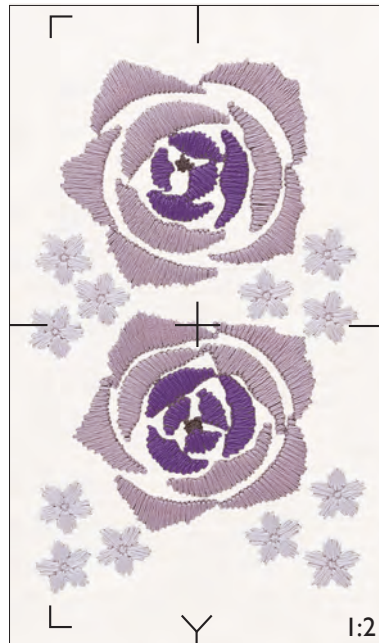

210 Handlook Needlework, design #4



214 Towel Magic, design #1

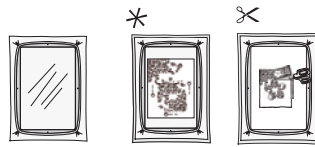

Stitches: 15 415
 Height: 146 mm
 Width: 146 mm
 Thread Velvet™

161

- 1 0569
2208
- * 0569
2208
- < 0569
2208
- * 0569
2208
- 5 1177
2321
- 6 1051
2226
- 7 1275
2555
- 8 1517
2449
- * 1517
2449
- < 1046
2515
- 11 1079
2597
- * 1079
2597
- < 1277
2214

Gütermann Sulky
 Robison - Anton

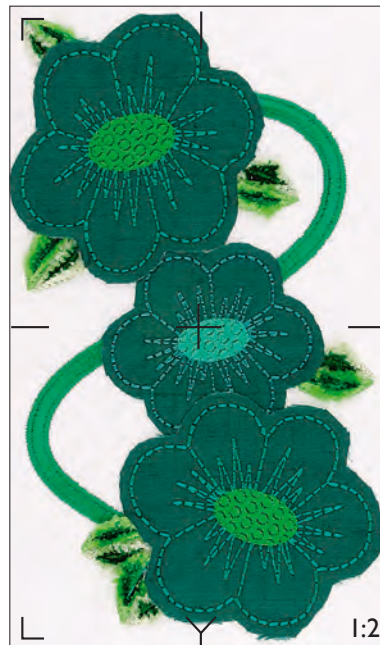

214 Towel Magic, design #2

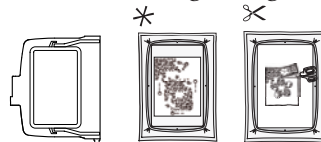













Stitches: 14 525
 Height: 166 mm
 Width: 95 mm
 Thread Velvet™

162

- 1 0569
2208
- 2 1177
2321
- 3 1051
2226
- 4 1275
2555
- 5 1517
2449
- * 1517
2449
- < 1046
2515
- 7 1079
2597
- * 1079
2597
- < 1277
2214

Gütermann Sulky
 Robison - Anton

Stitches: 23 579
Height: 228 mm
Width: 145 mm
Thread Velvet™

- 1  0569
2208
- 2  1177
2321
- 3  1051
2226
- 4  1275
2555
- 5  1517
2449
- *  1517
2449
- 6  1517
2449
- ✂  1046
2515
- 7  1079
2597
- 8  1079
2597
- *  1079
2597
- 9  1277
2214
- ✂  1277
2214

Gütermann Sulky
Robison - Anton

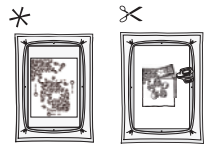

214 Towel Magic, design #3

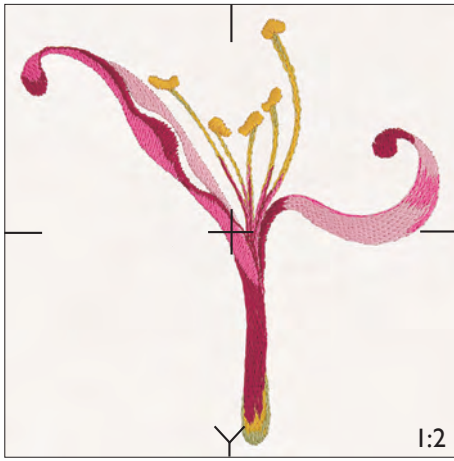

164

Stiches: 4 077
 Height: 115 mm
 Width: 111 mm

- 1 1124
2325
- 2 1104
2547
- 3 1121
2599
- 4 1109
2415
- 5 1533
2504

Gütermann Sulky
 Robison - Anton



165

Stiches: 8 264
 Height: 112 mm
 Width: 101 mm

- 1 1533
2504
- 2 1037
2420
- 3 1246
2467
- 4 1078
2469
- 5 1184
2467
- 6 1065
2465
- 7 1177
2457

Gütermann Sulky
 Robison - Anton

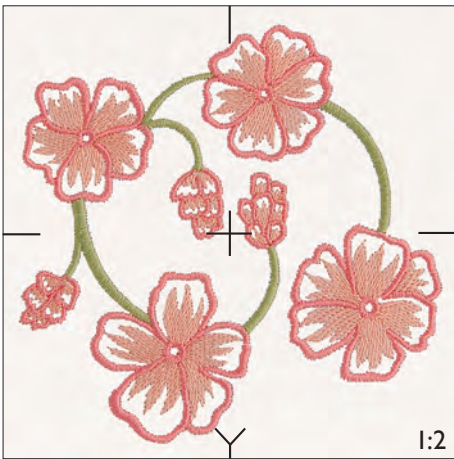

166

Stiches: 10 763
 Height: 106 mm
 Width: 114 mm

- 1 1001
2343
- 2 1167
2234
- 3 1227
2546
- 4 1056
2569

Gütermann Sulky
 Robison - Anton

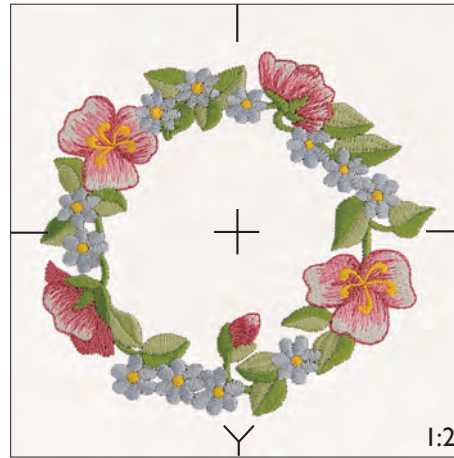

167

Stiches: 11 512
 Height: 98 mm
 Width: 106 mm

- 1 1104
2547
- 2 1177
2457
- 3 1002
2574
- 4 1117
2276
- 5 1119
2591
- 6 1165
2283
- 7 1023
2560

Gütermann Sulky
 Robison - Anton

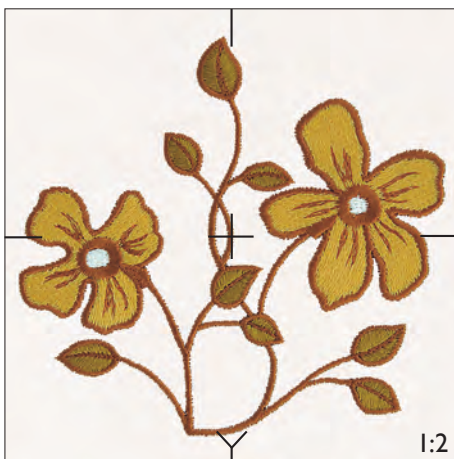

168

Stiches: 10 103
 Height: 112 mm
 Width: 112 mm

- 1 1104
2547
- 2 1064
2377
- 3 1016
2374

Gütermann Sulky
 Robison - Anton



169

Stiches: 10 203
 Height: 97 mm
 Width: 111 mm

- 1 1111
2285
- 2 1031
2340
- 3 1002
2343
- 4 1194
2288
- 5 1176
2595
- 6 1177
2457
- 7 1002
2574

Gütermann Sulky
 Robison - Anton

170

Stitches: 9 241
Height: 81 mm
Width: 93 mm

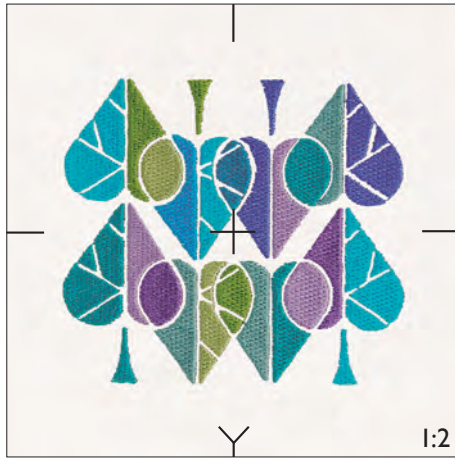

- | | | | | | |
|---|--|--------------|----|--|--------------|
| 1 | | 1226
2614 | 6 | | 1095
2306 |
| 2 | | 1193
2482 | 7 | | 1513
2446 |
| 3 | | 1194
2288 | 8 | | 1252
2730 |
| 4 | | 1205
2624 | 9 | | 1104
2547 |
| 5 | | 1251
2730 | 10 | | 1177
2457 |

Gütermann Sulky
Robison - Anton

171

Stitches: 6 773
Height: 116 mm
Width: 115 mm

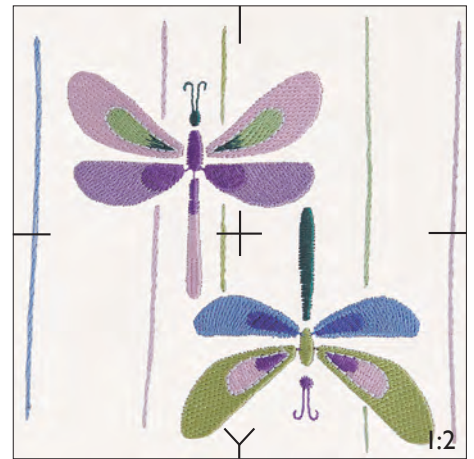

- | | | | | | |
|---|--|--------------|---|--|--------------|
| 1 | | 1028
2206 | 6 | | 1104
2547 |
| 2 | | 1076
2528 | 7 | | 1047
2238 |
| 3 | | 1111
2285 | 8 | | 1517
2449 |
| 4 | | 1193
2482 | 9 | | 1001
2343 |
| 5 | | 1194
2288 | | | |

Gütermann Sulky
Robison - Anton

172

Stitches: 4 013
Height: 154 mm
Width: 62 mm

- | | | |
|---|--|--------------|
| 1 | | 1234
2296 |
|---|--|--------------|

Gütermann Sulky
Robison - Anton

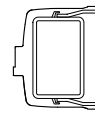
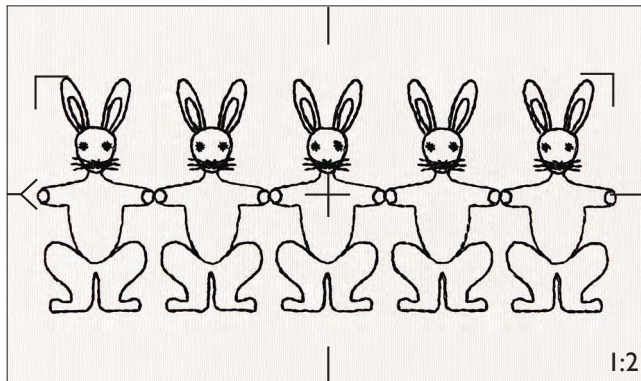

173

Stitches: 8 819
Height: 165 mm
Width: 40 mm

- | | | |
|---|--|--------------|
| 1 | | 1137
2331 |
| 2 | | 1195
2428 |
| 3 | | 1039
2508 |
| 4 | | 1207
2278 |
| 5 | | 1232
2315 |

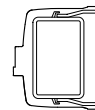
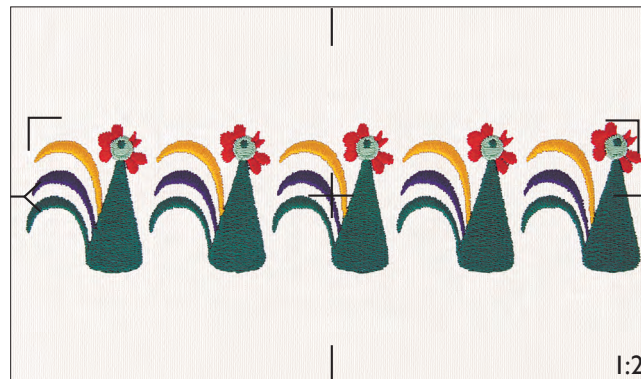

Gütermann Sulky
Robison - Anton





174

Stiches: 12 525
 Height: 115 mm
 Width: 85 mm

- 1  1023
2560
- 2  1071
2574
- 3  1255
2628



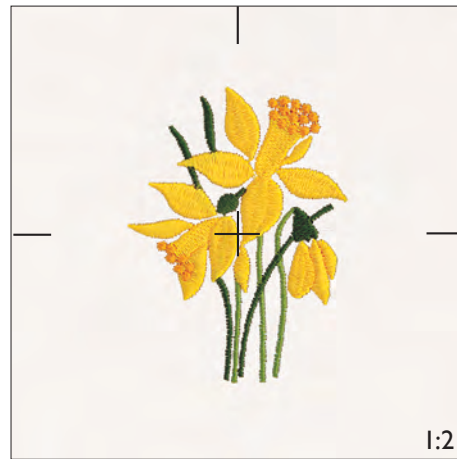

Gütermann Sulky
 Robison - Anton

1:2



175

Stiches: 4 793
 Height: 80 mm
 Width: 59 mm

- 1  1177
2457
- 2  1176
2595
- 3  1023
2560
- 4  1137
2331



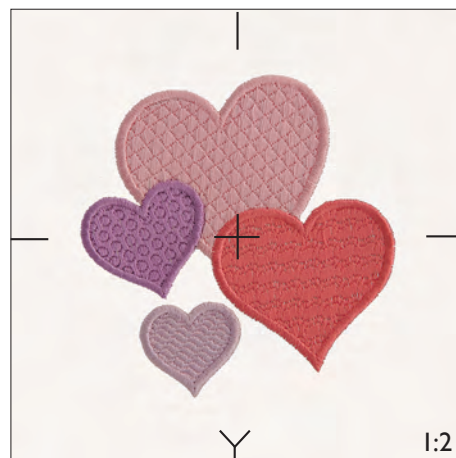

Gütermann Sulky
 Robison - Anton

1:2



176

Stiches: 10 193
 Height: 88 mm
 Width: 84 mm

- 1  1115
2223
- 2  1154
2412
- 3  1080
2588
- 4  1111
2285

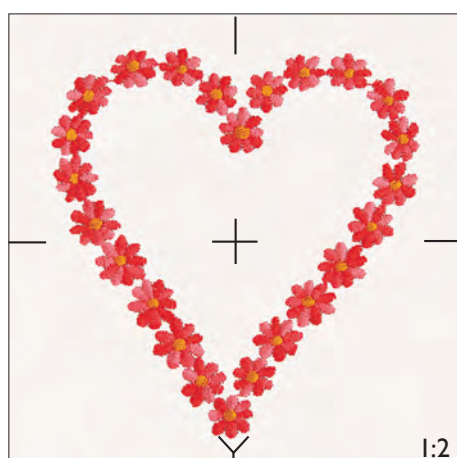

Gütermann Sulky
 Robison - Anton

1:2



177

Stiches: 6 648
 Height: 104 mm
 Width: 98 mm

- 1  2102
2262
- 2  1137
2331



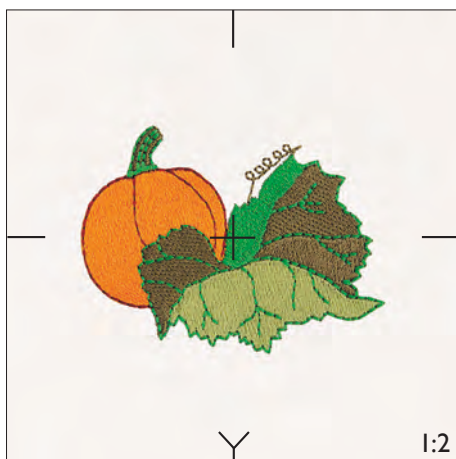

Gütermann Sulky
 Robison - Anton

1:2



178

Stiches: 7 459
 Height: 62 mm
 Width: 80 mm

- 1  1238
2409
- 2  1169
2249
- 3  1228
2477
- 4  1104
2547
- 5  1049
2214



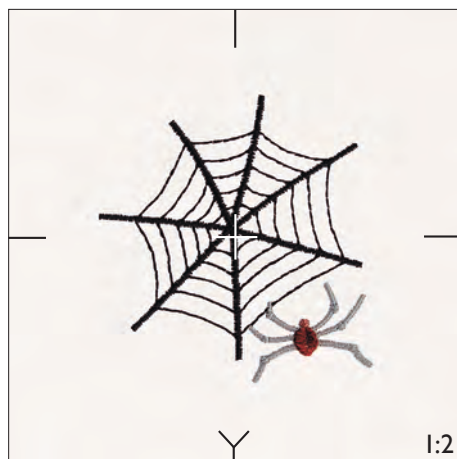

Gütermann Sulky
 Robison - Anton

1:2



179

Stiches: 2 656
 Height: 76 mm
 Width: 72 mm
 Thread Velvet™

- 1  1234
2296
- 2  1011
2618
- 3  7011
2231
- 4  1021
2289

Gütermann Sulky
 Robison - Anton

1:2

180

Stitches: 13 701
Height: 102 mm
Width: 114 mm



- | | | | | | | | | |
|---|------|------|----|------|------|------------------------------------|------|------|
| 1 | 1059 | 2576 | 6 | 1017 | 2413 | 11 | 1025 | 2400 |
| 2 | 1147 | 2263 | 7 | 1001 | 2343 | 12 | 1147 | 2263 |
| 3 | 1503 | 2514 | 8 | 1128 | 2273 | 13 | 1001 | 2343 |
| 4 | 1025 | 2400 | 9 | 1070 | 2557 | 14 | 1166 | 2265 |
| 5 | 1147 | 2263 | 10 | 1166 | 2265 | Gütermann Sulky
Robison - Anton | | |

181

Stitches: 14 435
Height: 110 mm
Width: 114 mm



- | | | | | | | | | |
|---|------|------|---|------|------|------------------------------------|------|------|
| 1 | 1128 | 2273 | 5 | 1166 | 2265 | 9 | 1166 | 2265 |
| 2 | 1170 | 2402 | 6 | 1147 | 2263 | 10 | 1170 | 2402 |
| 3 | 1001 | 2343 | 7 | 1017 | 2413 | 11 | 1025 | 2400 |
| 4 | 1147 | 2263 | 8 | 1001 | 2343 | Gütermann Sulky
Robison - Anton | | |

182

Stitches: 9 832
Height: 102 mm
Width: 110 mm



- | | | | | | | | | |
|---|------|------|----|------|------|------------------------------------|------|------|
| 1 | 1001 | 2343 | 6 | 1001 | 2343 | 11 | 1005 | 2296 |
| 2 | 1011 | 2618 | 7 | 1005 | 2296 | 12 | 1238 | 2409 |
| 3 | 1025 | 2400 | 8 | 1049 | 2214 | 13 | 1147 | 2263 |
| 4 | 1001 | 2343 | 9 | 1005 | 2296 | Gütermann Sulky
Robison - Anton | | |
| 5 | 1001 | 2343 | 10 | 1220 | 2217 | | | |

183

Stitches: 9 400
Height: 116 mm
Width: 97 mm



- | | | | | | | | | |
|---|------|------|----|------|------|------------------------------------|------|------|
| 1 | 1165 | 2283 | 6 | 1028 | 2206 | 11 | 1017 | 2413 |
| * | 1165 | 2283 | 7 | 1028 | 2206 | 12 | 1130 | 2563 |
| 2 | 1165 | 2283 | 8 | 1196 | 2433 | 13 | 1025 | 2400 |
| 3 | 1165 | 2283 | 9 | 1037 | 2420 | Gütermann Sulky
Robison - Anton | | |
| 4 | 1017 | 2413 | 10 | 1016 | 2374 | | | |
| 5 | 1028 | 2206 | | | | | | |

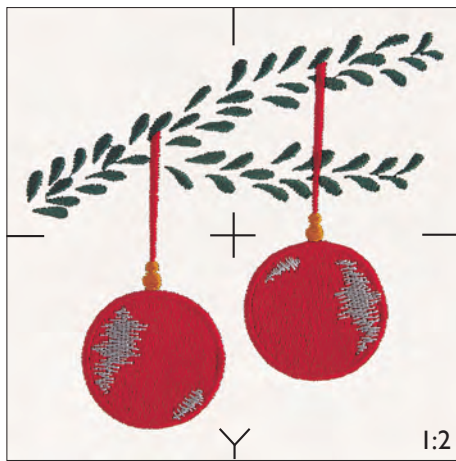

184

Stiches: 10 871
 Height: 106 mm
 Width: 111 mm

- 1 1232
2315
- 2 1147
2263
- 3 1025
2400
- 4 1011
2618

Gütermann Sulky
 Robison - Anton



185

Stiches: 7 621
 Height: 110 mm
 Width: 111 mm

- 1 1168
2328
- 2 1059
2576
- 3 1147
2263
- 4 1185
2466
- 5 1101
2390

Gütermann Sulky
 Robison - Anton



186

Stiches: 16 322
 Height: 115 mm
 Width: 93 mm
 Thread Velvet™

- 1 1319
2263
- 2 0534
2270
- 3 0619
2232
- 4 1016
2511
- 5 1101
2410
- 6 1186
2251
- 7 1071
2342
- 8 1001
2539
- 9 1082
2538
- 10 1210
2728

95 Special Techniques, design #3

Gütermann Sulky
 Robison - Anton

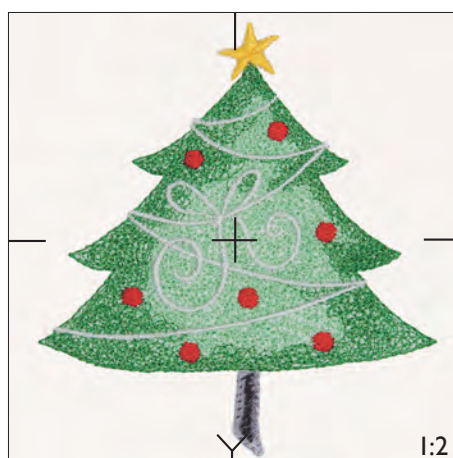

187

Stiches: 15 441
 Height: 116 mm
 Width: 107 mm
 Thread Velvet™











- 1 1124
2626
- 2 1049
2211
- 3 1101
2410
- 4 1319
2263
- 5 1210
2728
- 6 1327
2405
- 7 1001
2539

95 Special Techniques, design #19

Gütermann Sulky
 Robison - Anton

188

Stitches: 8 992
Height: 91 mm
Width: 96 mm

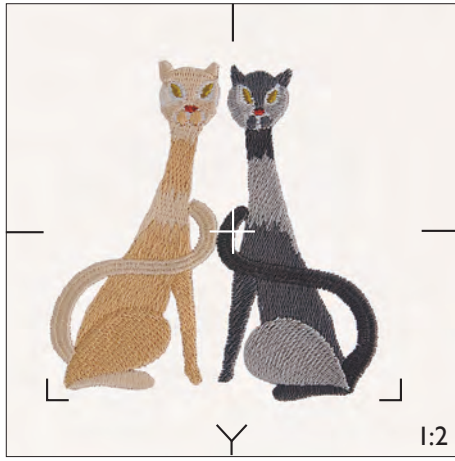

- 1  1001
2343
- 2  1166
2265
- 3  1219
2484
- 4  1220
2217
- 5  1219
2484
- 6  1127
2476
- 7  1055
2234
- 8  1127
2476
- 9  1216
2205
- 10  1227
2562

Gütermann Sulky
Robison - Anton



189

Stitches: 4 981
Height: 89 mm
Width: 64 mm

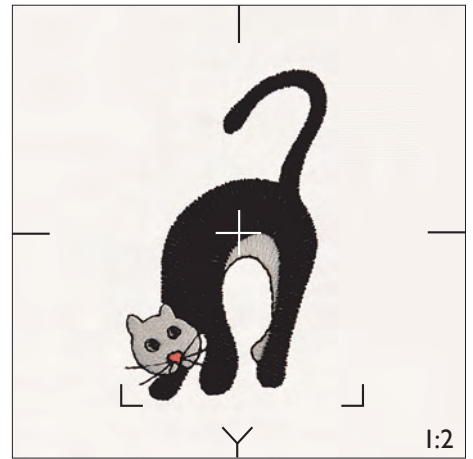

- 1  1001
2343
- 2  1020
2414
- 3  1005
2296

Gütermann Sulky
Robison - Anton



190

Stitches: 4 128
Height: 45 mm
Width: 66 mm

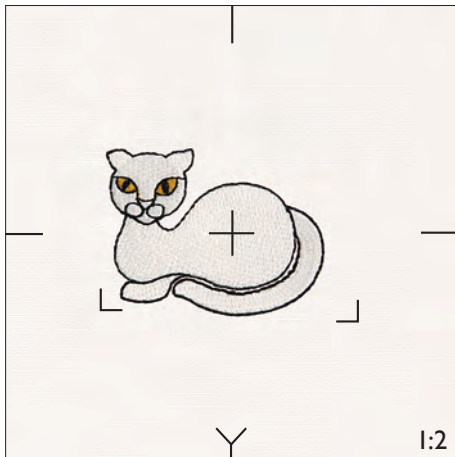

- 1  1001
2343
- 2  1227
2562
- 3  1005
2296

Gütermann Sulky
Robison - Anton



191

Stitches: 5 695
Height: 45 mm
Width: 67 mm



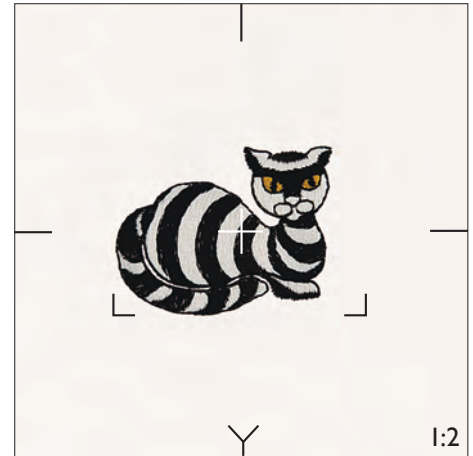

- 1  1001
2343
- 2  1227
2562
- 3  1005
2296

Gütermann Sulky
Robison - Anton



192

Stitches: 4 440
Height: 45 mm
Width: 58 mm

- 1  1001
2343
- 2  1513
2446
- 3  1020
2414
- 4  1005
2296

Gütermann Sulky
Robison - Anton

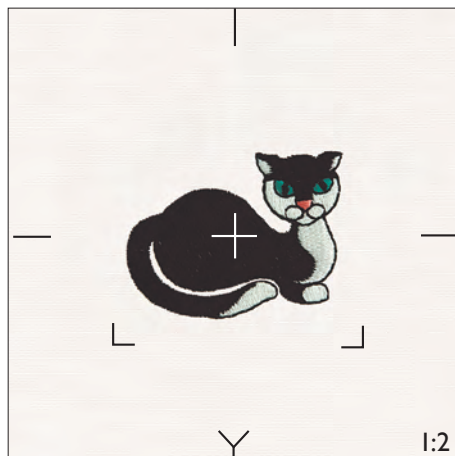

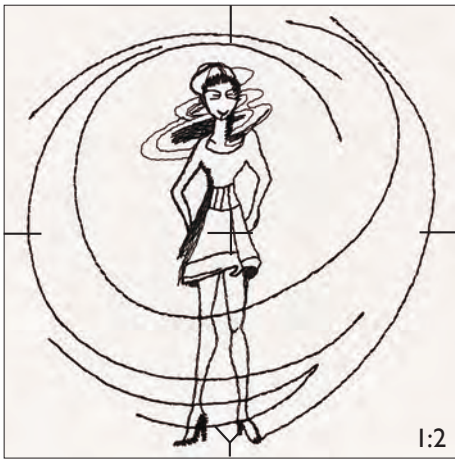

193

Stitches: 2 431
Height: 115 mm
Width: 108 mm

1 ■ 1234
2296

Gütermann Sulky
Robison - Anton

1:2

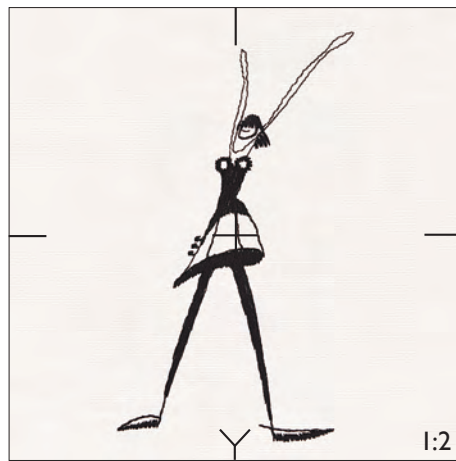

194

Stitches: 1 237
Height: 110 mm
Width: 62 mm

1 ■ 1234
2296

Gütermann Sulky
Robison - Anton

1:2

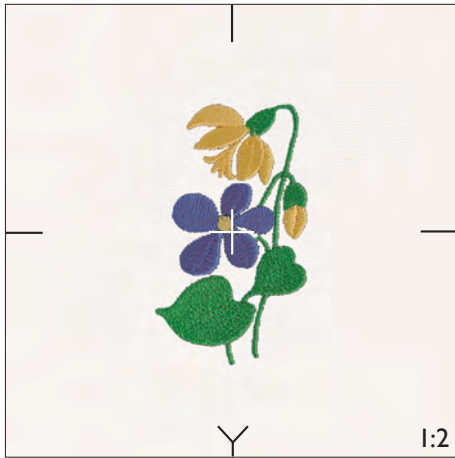

195

Stitches: 3 516
Height: 70 mm
Width: 41 mm

1 ■ 1049
2214
2 ■ 1226
2614
3 ■ 1135
2234

Gütermann Sulky
Robison - Anton

1:2



196

Stitches: 6 855
Height: 84 mm
Width: 59 mm

1 ■ 1001
2343
2 ■ 1017
2413
3 ■ 1135
2234
4 ■ 1239
2394
5 ■ 1037
2420
6 ■ 1154
2412
7 ■ 1220
2217
8 ■ 1224
2237
9 ■ 1191
2590
10 ■ 1196
2433
11 ■ 1177
2457

Gütermann Sulky
Robison - Anton

1:2

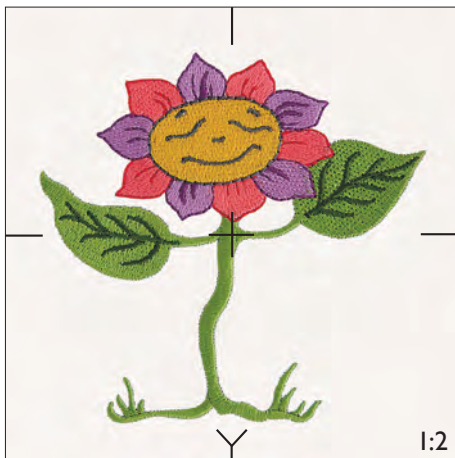

197

Stitches: 10 013
Height: 100 mm
Width: 101 mm

1 ■ 1177
2457
2 ■ 1176
2595
3 ■ 1154
2412
4 ■ 1147
2263
5 ■ 1080
2588
6 ■ 1255
2628
7 ■ 1023
2561
8 ■ 1041
2407

Gütermann Sulky
Robison - Anton

1:2

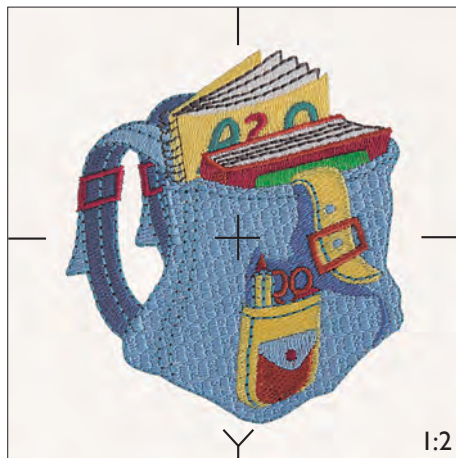

198

Stitches: 20 029
Height: 100 mm
Width: 90 mm

1 ■ 1198
2275
2 ■ 1028
2206
3 ■ 1251
2730
4 ■ 1190
2611
5 ■ 1001
2343
6 ■ 1135
2234
7 ■ 1251
2730
8 ■ 1190
2611
9 ■ 1237
2608
10 ■ 1049
2214
11 ■ 1220
2217
12 ■ 1028
2206
13 ■ 1076
2528
14 ■ 1135
2234
15 ■ 1190
2611
16 ■ 1237
2608
17 ■ 1028
2206
18 ■ 1251
2730

Gütermann Sulky
Robison - Anton

1:2

199

Stitches: 14 956
Height: 99 mm
Width: 109 mm

- 1 1047
2238
- 2 1120
2582
- 3 1121
2599
- 4 1047
2238
- 5 1117
2374
- 6 1025
2400
- 7 1080
2588
- 8 1135
2234
- 9 1056
2569

Gütermann Sulky
Robison - Anton

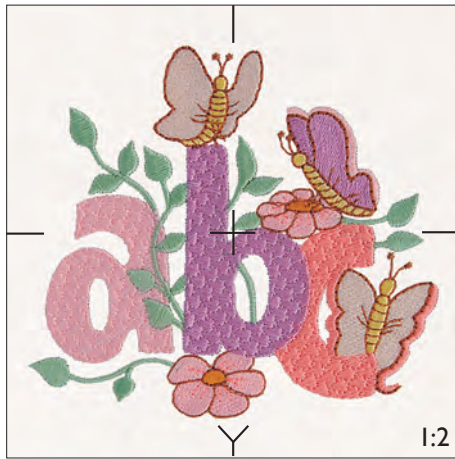

200

Stitches: 14 301
Height: 74 mm
Width: 109 mm

- 1 1228
2477
- 2 1212
2729
- 3 1149
2593
- 4 1128
2273
- 5 1170
2402
- 6 1011
2618
- 7 1220
2217
- 8 1071
2574

Gütermann Sulky
Robison - Anton

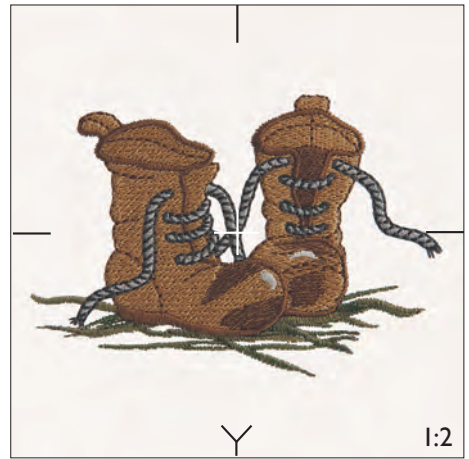

201

Stitches: 15 919
Height: 98 mm
Width: 106 mm

- 1 1225
2599
- 2 1117
2276
- 3 1119
2591
- 4 1167
2234
- 5 1001
2343
- 6 1137
2331
- 7 1056
2569

Gütermann Sulky
Robison - Anton



202

Stitches: 6 628
Height: 62 mm
Width: 83 mm

- 1 1045
2310
- 2 1046
2393
- 3 1030
2598
- 4 1095
2307
- 5 1090
2446
- 6 1226
2614
- 7 1298
2407
- 8 1193
2482
- 9 1137
2331
- 10 1235
2428
- 11 1234
2296

Gütermann Sulky
Robison - Anton

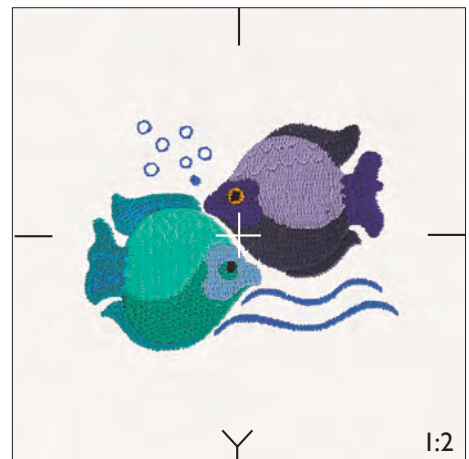

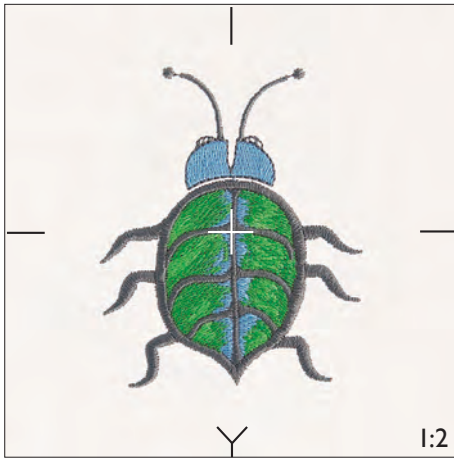

203

Stiches: 7 735
 Height: 86 mm
 Width: 69 mm

- 1 1201
2239
- 2 1510
2211
- 3 1049
2214
- 4 1041
2407

Gütermann Sulky
 Robison - Anton



204

Stiches: 4 419
 Height: 71 mm
 Width: 43 mm

- 1 1177
2738
- 2 1051
2580
- 3 1248
2388
- 4 1002
2343
- 5 1067
2316
- 6 1124
2235
- 7 1039
2467
- 8 1005
2215

Gütermann Sulky
 Robison - Anton

47 Butterflies, design #17

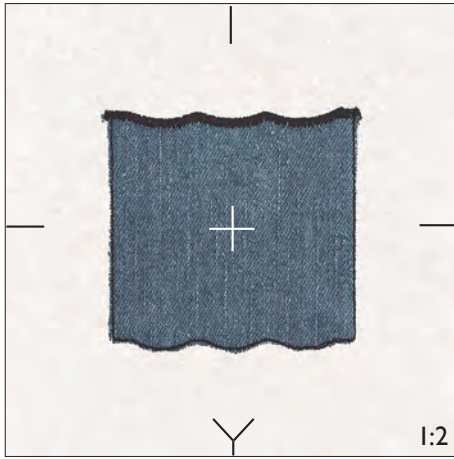

205

Stiches: 855
 Height: 64 mm
 Width: 67 mm

- 1 1234
2296
- * 1234
2296
- 2 1234
2296
- 3 1234
2296

Gütermann Sulky
 Robison - Anton

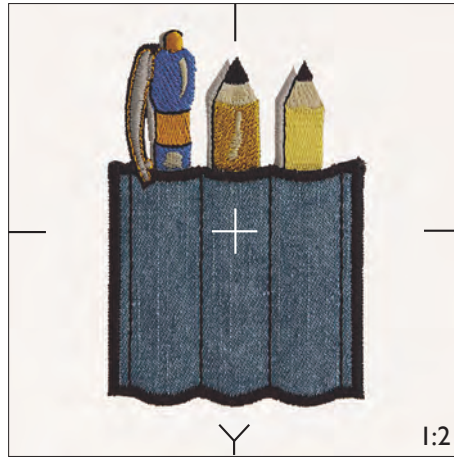

206

Stiches: 6 213
 Height: 100 mm
 Width: 68 mm

- 1 1011
2618
- 2 1076
2528
- 3 1025
2400
- 4 1082
2232
- 5 1159
2400
- 6 1127
2476
- 7 1167
2234
- 8 1234
2296
- 9 1234
2296
- * 1234
2296
- 10 1234
2296
- 11 1011
2618
- 12 1025
2400

Gütermann Sulky
 Robison - Anton

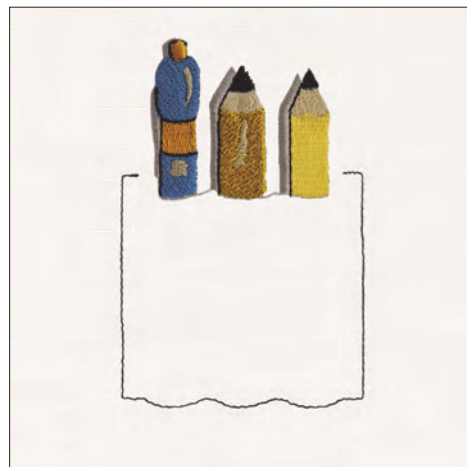
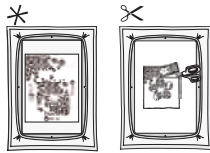

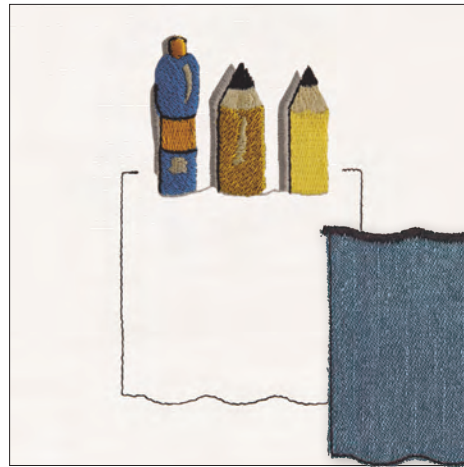

- Step 1
- 1 1011
2618
 - 2 1076
2528
 - 3 1025
2400
 - 4 1082
2232
 - 5 1159
2400
 - 6 1127
2476
 - 7 1167
2234
 - 8 1234
2296
 - 9 1234
2296



- Step 2
- 10 1234
2296
 - 11 1011
2618
 - 12 1025
2400
- Gütermann Sulky
 Robison - Anton

207

Stitches: 524
 Height: 29 mm
 Width: 17 mm



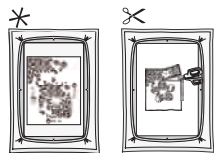
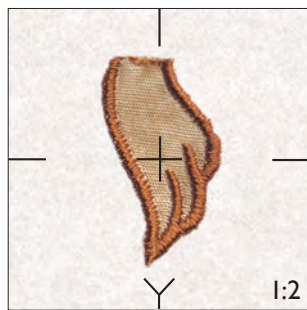

- 1  1056
2227
- * 2  1056
2227
- 3  1056
2227

Gütermann Sulky
 Robison - Anton



208

Stitches: 1 802
 Height: 32 mm
 Width: 75 mm

- 1  1056
2227
- * 2  1056
2227
- 3  1005
2215
- 4  1056
2227

Gütermann Sulky
 Robison - Anton

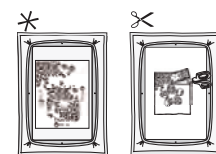

209



Step 1
 Δ design #179

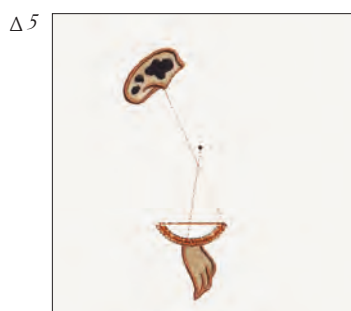

Step 2
 Δ design #180

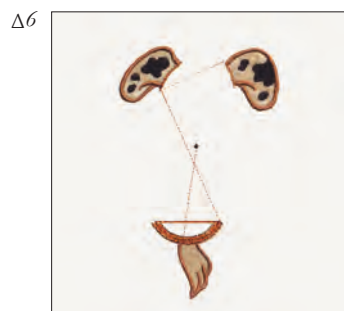

Step 3
 Δ design #180

Stitches: 8 722
 Height: 97 mm
 Width: 132 mm



129 Pop-Up-Pals, design #9

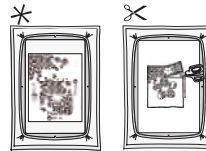





- 1 ■ 1056 2227
- Δ 1056 2227
- 2 ■ 1056 2227
- * 1056 2227
- 3 ■ 1056 2227
- ✂ 1056 2227
- 4 ■ 1056 2227
- Δ 1056 2227
- 5 ■ 1056 2227
- Δ 1056 2227
- 6 ■ 1056 2227
- 7 ■ 1028 2527
- * 1028 2527
- 8 ■ 1028 2527
- ✂ 1028 2527
- 9 ■ 1028 2527
- 10 ■ 1056 2227
- * 1056 2227
- 11 ■ 1056 2227
- ✂ 1002 2343
- 12 □ 1002 2343
- 13 ■ 1126 2289
- 14 ■ 1037 2467
- 15 ■ 1117 2374
- 16 ■ 1005 2215
- 17 ■ 1056 2227

Gütermann Sulky
 Robison - Anton



210

Stitches: 4 039
Height: 86 mm
Width: 52 mm

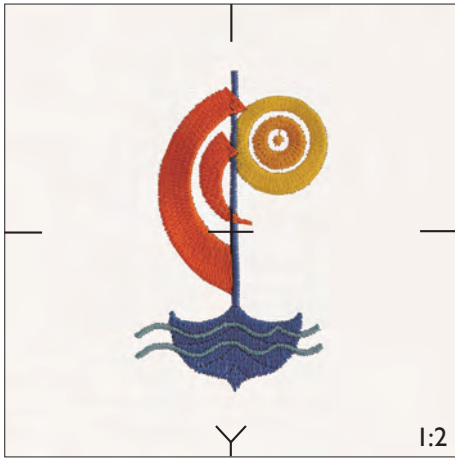

- 1  1137
2331
- 2  1023
2560
- 3  1076
2528
- 4  1168
2328
- 5  1205
2624

Gütermann Sulky
Robison - Anton



211

Stitches: 3 722
Height: 73 mm
Width: 63 mm



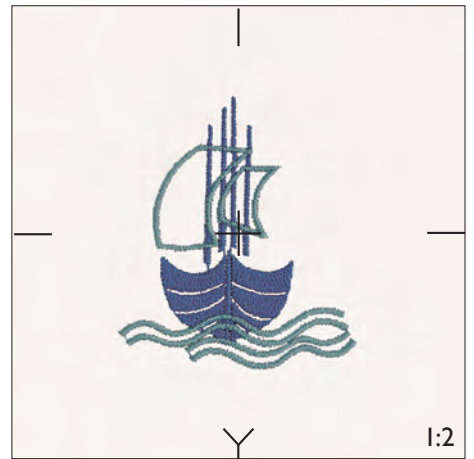

- 1  1076
2528
- 2  1205
2624

Gütermann Sulky
Robison - Anton



212

Stitches: 4 181
Height: 38 mm
Width: 92 mm

- 1  1081
2480
- 2  1198
2341
- 3  1248
2239
- 4  1234
2296

Gütermann Sulky
Robison - Anton

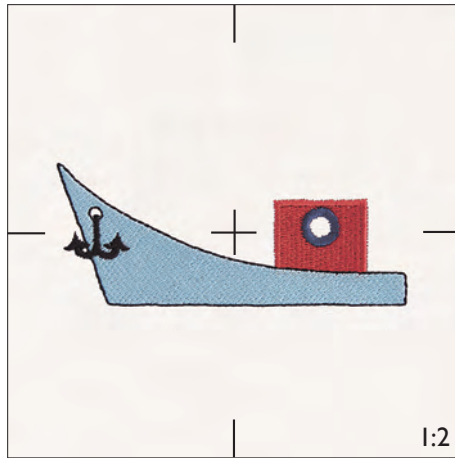

213

Stitches: 330
Height: 9 mm
Width: 59 mm



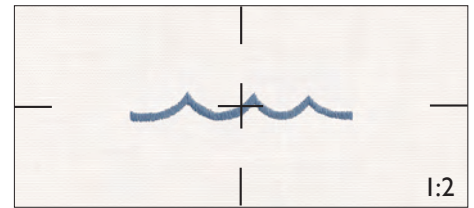

- 1  1028
2206

Gütermann Sulky
Robison - Anton



214

Stitches: 5 195
Height: 95 mm
Width: 63 mm



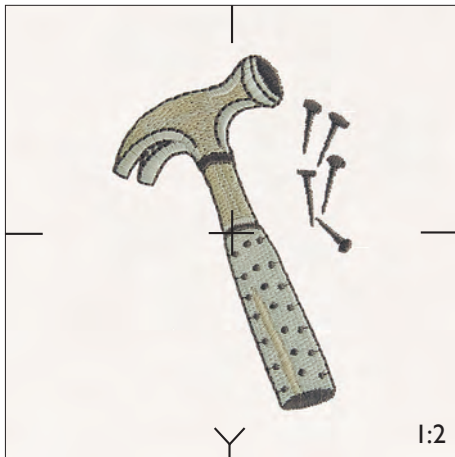

- 1  1071
2574
- 2  1236
2582
- 3  1011
2618
- 4  1166
2265

Gütermann Sulky
Robison - Anton



215

Stitches: 6 397
Height: 98 mm
Width: 77 mm

- 1  1071
2574
- 2  1011
2618
- 3  1166
2265
- 4  1128
2273
- 5  1179
2729

Gütermann Sulky
Robison - Anton

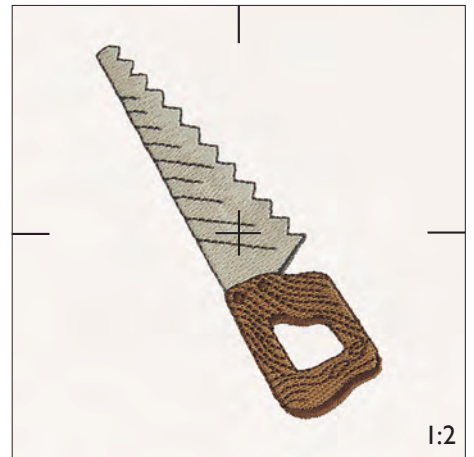

Stitches: 5 827
 Height: 105 mm
 Width: 77 mm

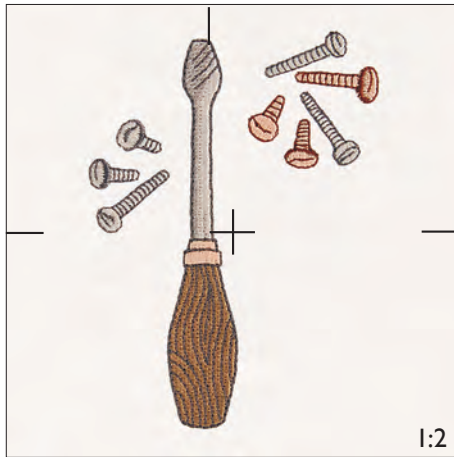







- 1 1002
2574
- 2 1011
2618
- 3 1128
2273
- 4 1239
2394
- 5 1166
2265
- 6 1057
2251

Gütermann Sulky
 Robison - Anton



217

Stitches: 26 864
 Height: 348 mm
 Width: 146 mm

- 1  7013
2509
- 2  1309
2418
- 3  1188
2509
- 4  1231
2261
- 5  7055
2205
- A *  1188
2509

Gütermann Sulky
 Robison - Anton



Supplies:

- 2 pcs of fabric 20"x12" (50x30 cm)
- 1 piece of stabilizer 20"x12" (50x30 cm)
- assorted embroidery threads.

184 Purse Pizzazz,
 design #3

1:2

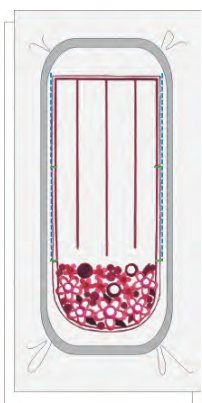

Hoop 1 piece of fabric and stabilizer. Embroider color #1-5.

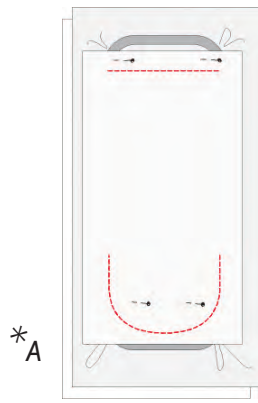

*A

Place lining on top of the embroidery, right side down. Embroider color #6.

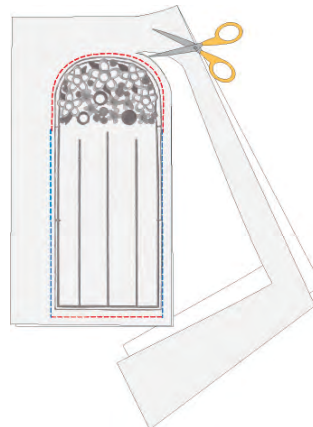

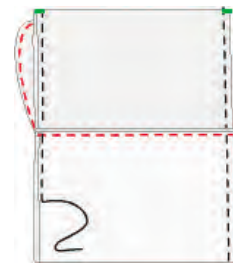

Remove from hoop. Tear away the stabilizer. Cut 3/8" (1 cm) outside the basting stitches.



Fold right sides together at the stitched marks, marked in green on the picture. Sew the sides together. Leave an opening in the lining. Turn the right side out and press.

Stitches: 17 737
 Height: 356 mm
 Width: 56 mm

- 1  1035
2249
- 2  1035
2249
- 3  1558
2228

Gütermann Sulky
 Robison - Anton



186 Mega Madeira Borders, design #7

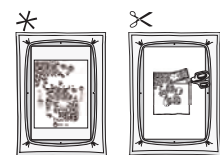

Step 1 Hoop the background fabric with stabilizer underneath and the top fabric at least 9" (23 cm) wide on top with overlap. The bottom fabric will come at the right side.

Step 2 Trim the top fabric from the right side of the stitching. Finish the embroidery.

Step 1



Step 2



219

Stitches: 26 864
Height: 348 mm
Width: 146 mm

1 ■ 1250
2520

Gütermann Sulky
Robison - Anton

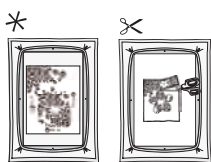
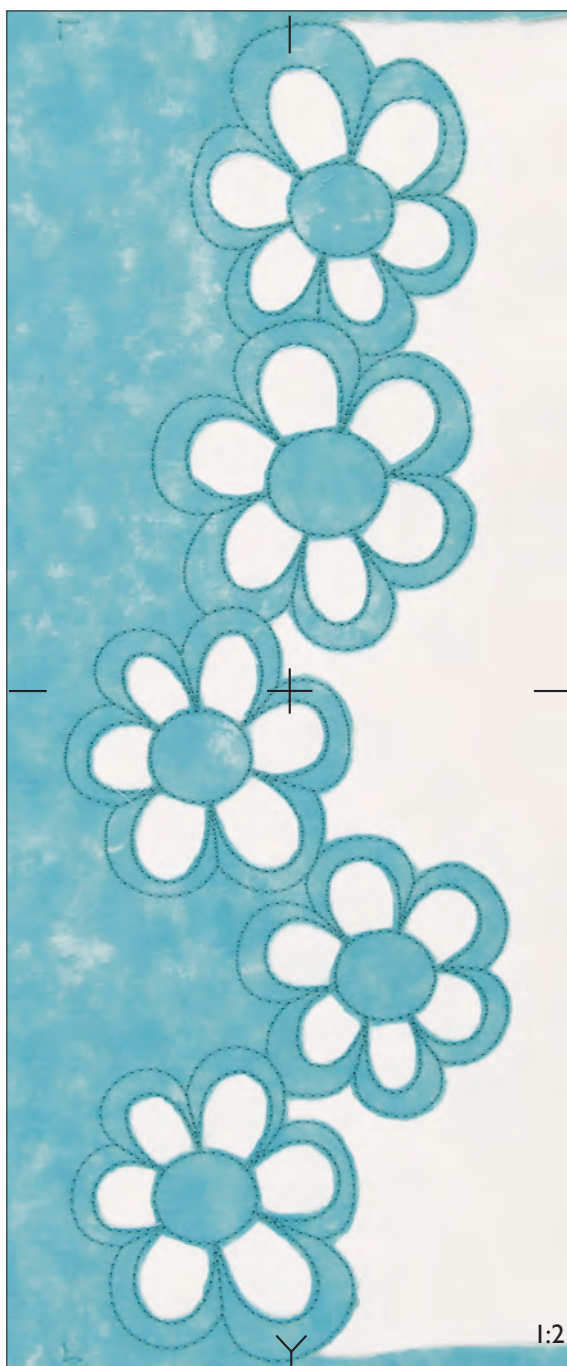

186 Mega Madeira Borders, design #9

- Step 1** Hoop the background fabric with stabilizer underneath and the top fabric at least 9" (23 cm) wide on top with overlap. The bottom fabric will come at the right side.
- Step 2** Remove from hoop and trim the top fabric from the right side close to the edges of the embroidery stitching. This is a raw edge embroidery.

Step 1





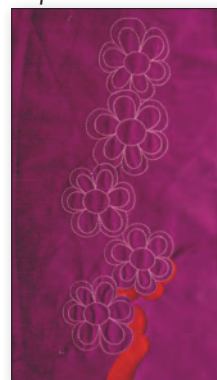



Step 2





Stiches: 14 918
Height: 343 mm
Width: 307 mm

- 1:1  1170
2402
- 1:2  7007
2586
- 1:3  1190
2611
- 2:1  1170
2402
- 2:2  7007
2586
- 2:3  1190
2611

Gütermann Sulky
Robison - Anton



Stitches: 14 996
 Height: 341 mm
 Width: 179 mm

- 1:1 1169
 2252
- 1:2 1169
 2252
- 2:1 1169
 2252
- 2:2 1169
 2252

Gütermann Sulky
 Robison - Anton

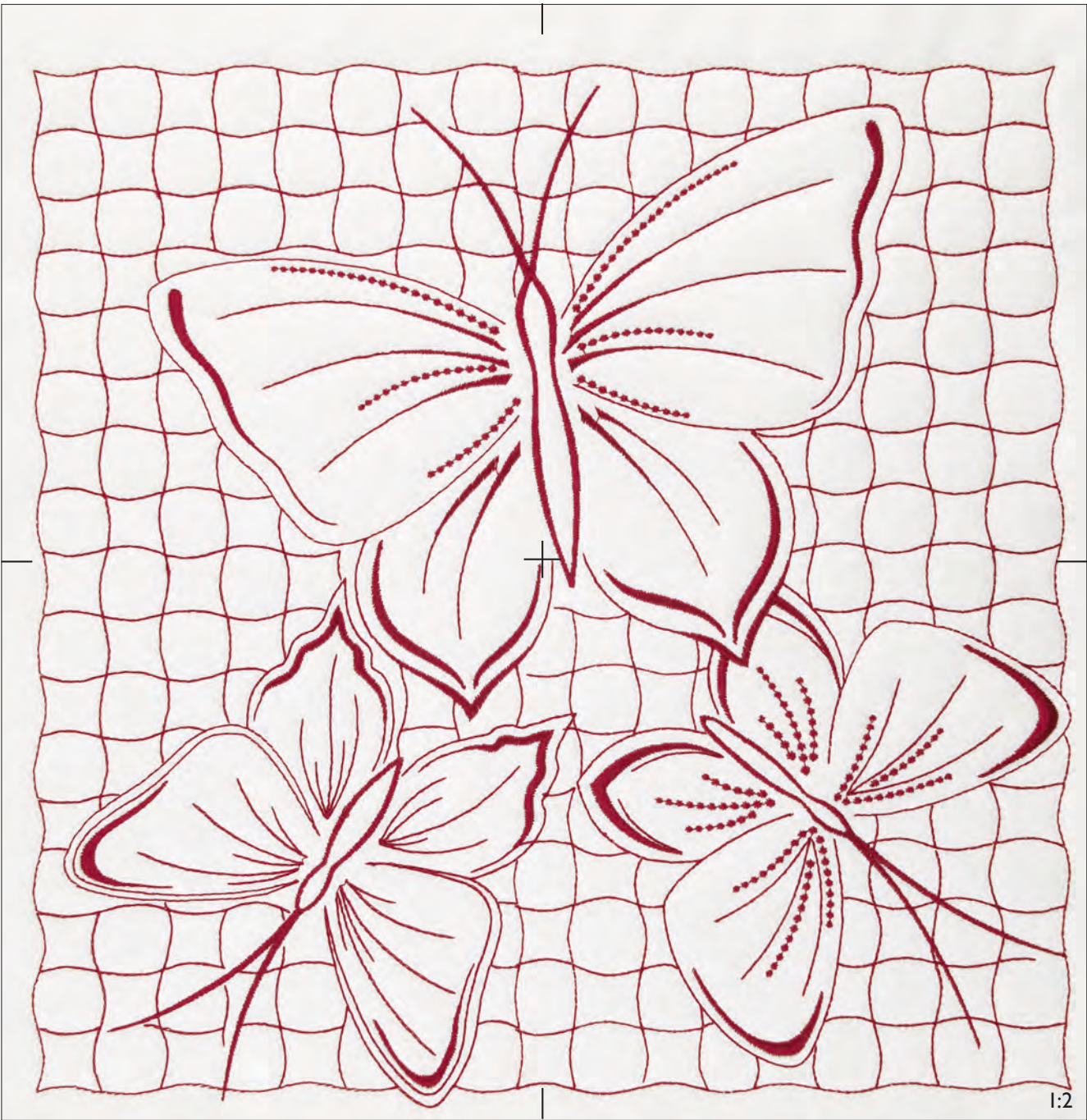

206 Majestic Quilting, design #1

222

Stitches: 7 601
Height: 165 mm
Width: 94 mm

1 ■ 1169
2252

Gütermann Sulky
Robison - Anton

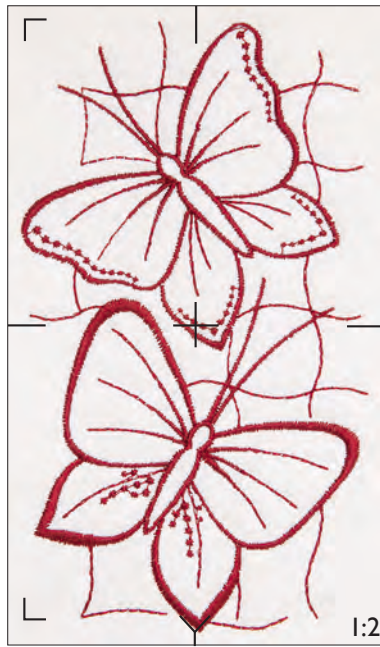
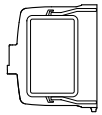

206 Majestic Quilting, design #2

223

Stitches: 2 926
Height: 145 mm
Width: 145 mm

1 ■ 1190
2611

Gütermann Sulky
Robison - Anton

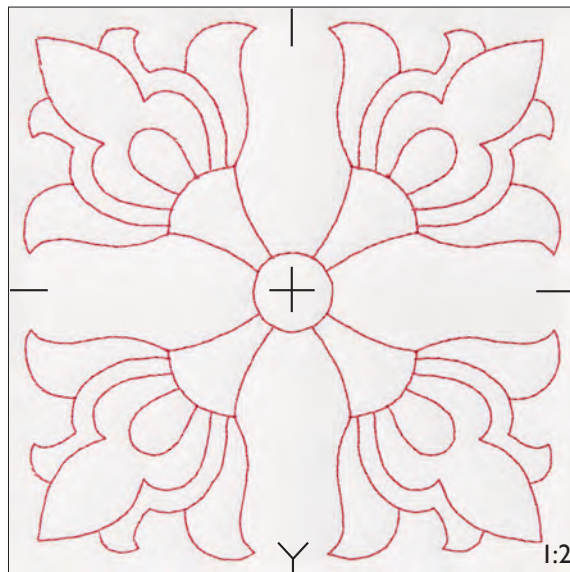

209 Majestic Yarn Quilting, design #16

Stitches: 6 208
Height: 319 mm
Width: 156 mm

1:1 1190
2611
2:1 1190
2611

Gütermann Sulky
Robison - Anton

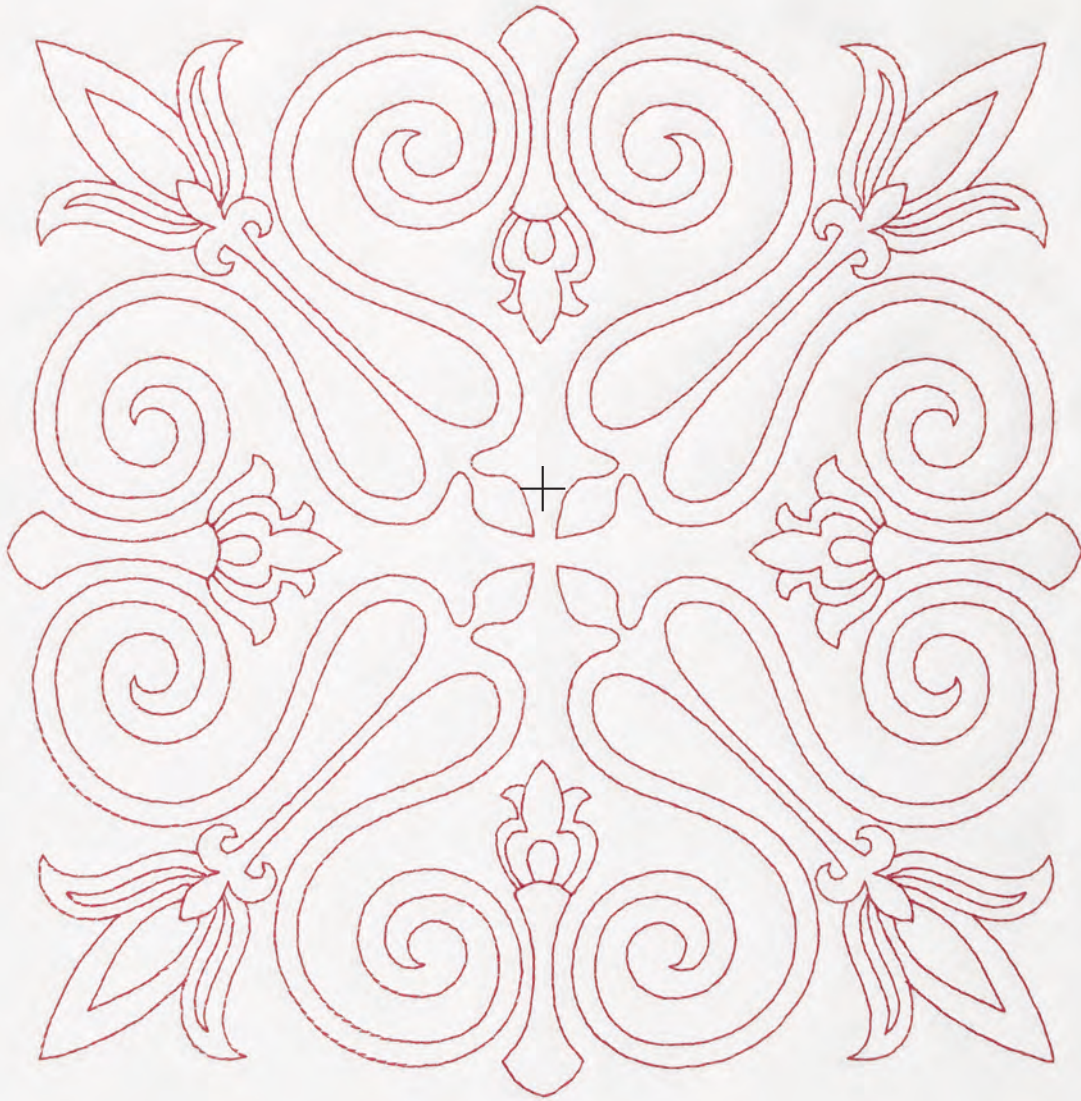

1:2

Preparing the machine for couching

1. Thread the machine with thread that matches the yarn.
2. Attach the proper yarn guides for your machine to the notches under the handle on the rear side of the machine (see fig. 1).
3. Pull out as much yarn as you need from the ball of yarn and place it as shown in fig. 2.
4. Place the yarn in the yarn guides (see fig. 2). It is very important that the yarn runs easily while you are sewing. You might need to guide the yarn through the yarn guides to make sure that it does not get twisted.
5. Choose Yarn Couching Foot 1 or 2, depending on the size of the yarn. Yarn Couching Foot 1 is suitable for most yarn sizes.
6. Thread the yarn from above through the hole in the foot using the yarn threader (see fig. 3). We recommend using yarn with even thickness. For best result the yarn should fill the hole in the foot and still run easily through it.
7. Snap on the foot to the machine (see fig. 4).
8. Deactivate deLuxe™ Stitch System icon in Machine Settings menu.



fig. 1

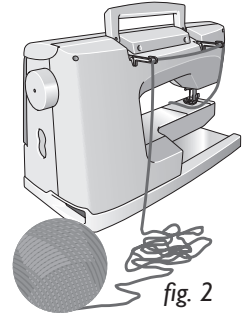

fig. 2

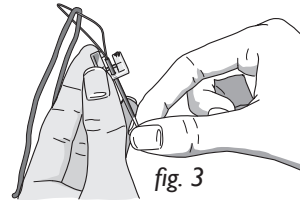

fig. 3

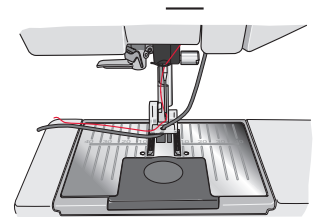

fig. 4

1. Prepare the machine for couching as described above.
2. Prepare the machine for embroidery.
3. Choose a HUSQVARNA VIKING® Yarn Couching embroidery design.
4. Set the machine to a low speed.
5. Hold the yarn end and start embroidering.
6. When the embroidery is completed you can either cut the yarn ends, or thread them on a darning needle and pull them to the back of the fabric.



Foot 1



Stitches: 9 395
Height: 345 mm
Width: 175 mm

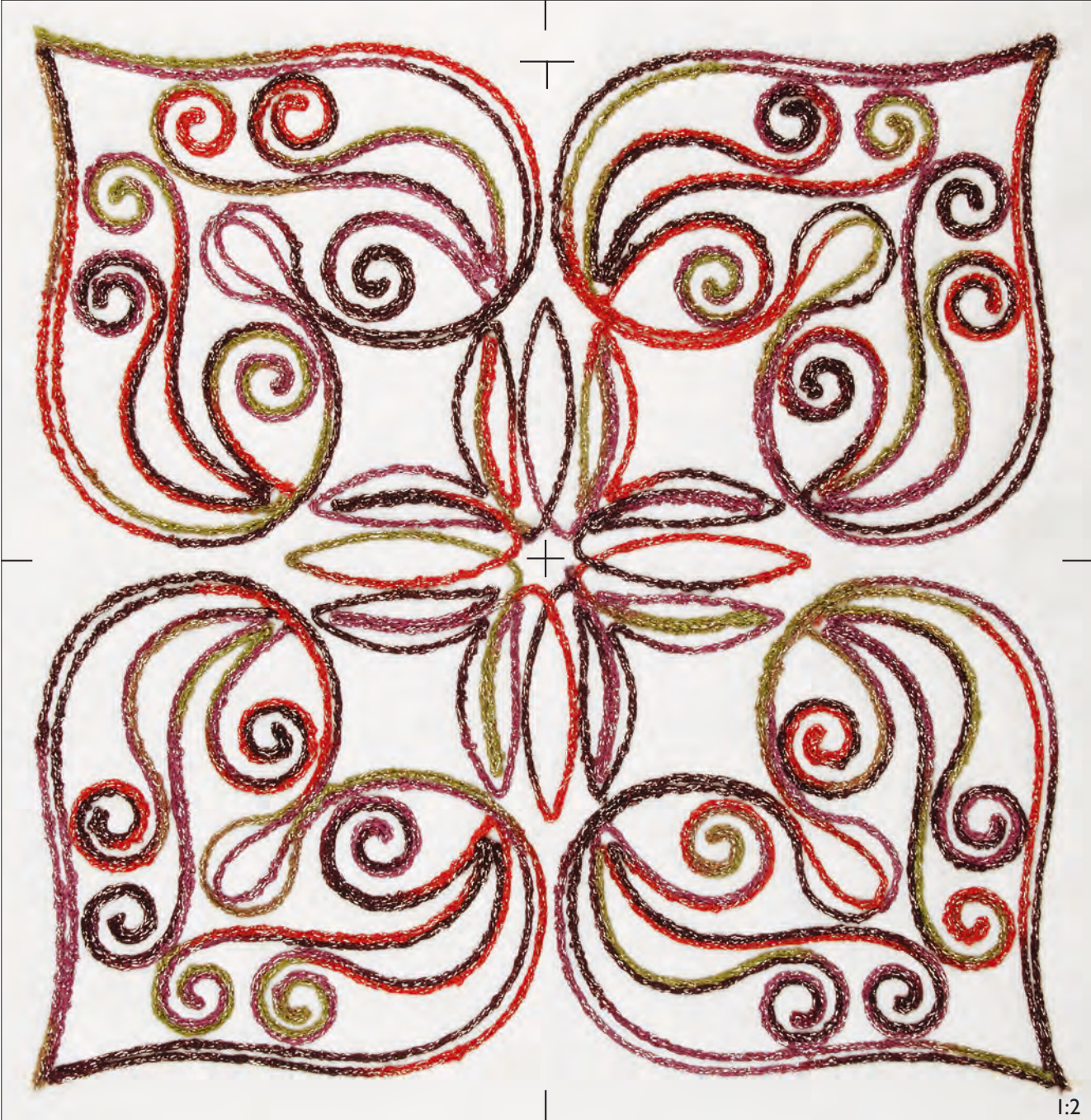

- ❖ 1:1 1190 2611
- ❖ 1:2 1190 2611
- ❖ 1:3 1190 2611
- ❖ 1:4 1190 2611
- ❖ 1:5 1190 2611
- ❖ 1:6 1190 2611
- ❖ 1:7 1190 2611
- ❖ 1:8 1190 2611
- ❖ 2:1 1190 2611
- ❖ 2:2 1190 2611
- ❖ 2:3 1190 2611
- ❖ 2:4 1190 2611
- ❖ 2:5 1190 2611
- ❖ 2:6 1190 2611
- ❖ 2:7 1190 2611

Gütermann Sulky
Robison - Anton



209 Majestic Yarn Quilting, design #1



Stitches: 13 752
Height: 225 mm
Width: 146 mm



- 1 ■ 1214
2339
- 2 ■ 1189
2563
- 3 ■ 1237
2608
- ❖ 4 ■ 1082
2232
- ❖ 5 ■ 1267
2610

Gütermann Sulky
Robison - Anton



207 Decorative with Yarn Couching, design #7

Stitches: 3 271
Height: 232 mm
Width: 147 mm



- 1 ■ 1267
2610
- ❖ 2 ■ 1267
2610
- ❖ 3 ■ 1082
2232

Gütermann Sulky
Robison - Anton



207 Decorative with Yarn Couching, design #16

Cutwork Needle Embroidery

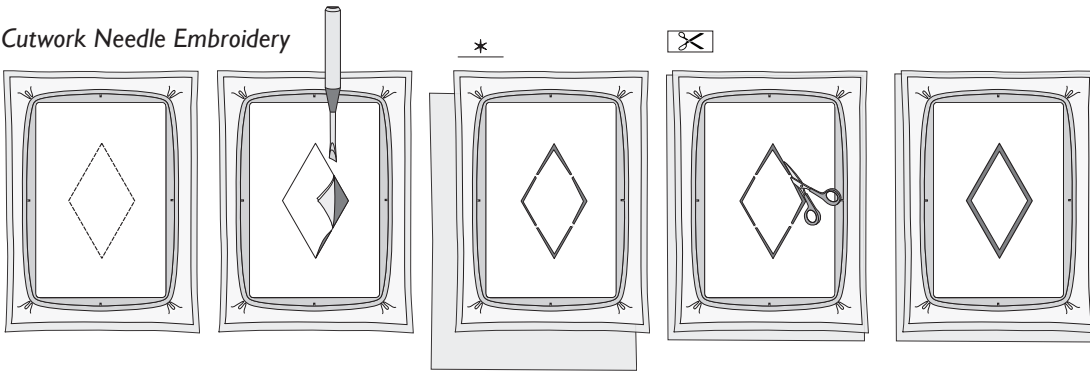

(✂) Cut inside marked area if not using INSPIRA™
Cutwork Needles

* Add a new water soluble stabilizer underneath

✂ Trim and remove the cut fabric if using INSPIRA™
Cutwork Needles

🧹 Clean the Bobbin Area



Needle #1 INSPIRA™ Cutwork Needles



Needle #2 INSPIRA™ Cutwork Needles



Needle #3 INSPIRA™ Cutwork Needles



Needle #4 INSPIRA™ Cutwork Needles







Remove needle thread when using INSPIRA™ Cutwork Needles.

For best results use straight stitch plate and sensor Q-Foot



228

Stitches: 31 797
Height: 214 mm
Width: 144 mm

- 1  **1169**
2225
- (✂) Cut inside marked area if not using INSPIRA™ Cutwork Needles
- 2  Needle #1
- 3  Needle #2
- * Add a heavy weight water soluble stabilizer underneath the hoop
- 4  **1169**
2225
-  Trim and remove the cut fabric
- 5  **1169**
2225
-  Clean the Bobbin Area



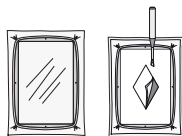





Gütermann Sulky
Robison - Anton



230 Easy Cutwork, design #1

229

Stitches: 23 168
Height: 165 mm
Width: 97 mm

- 1  **1169**
2225
- (✂) Cut inside marked area if not using INSPIRA™ Cutwork Needles
- 2  Needle #1
- 3  Needle #2
- * Add a heavy weight water soluble stabilizer underneath the hoop
- 4  **1169**
2225
-  Trim and remove the cut fabric
- 5  **1169**
2225
-  Cut edge
- 6  **1169**
2225
-  Clean the Bobbin Area

Gütermann Sulky
Robison - Anton



230 Easy Cutwork, design #2

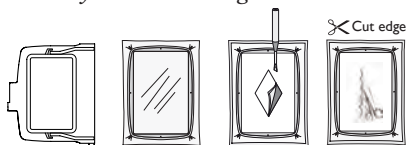

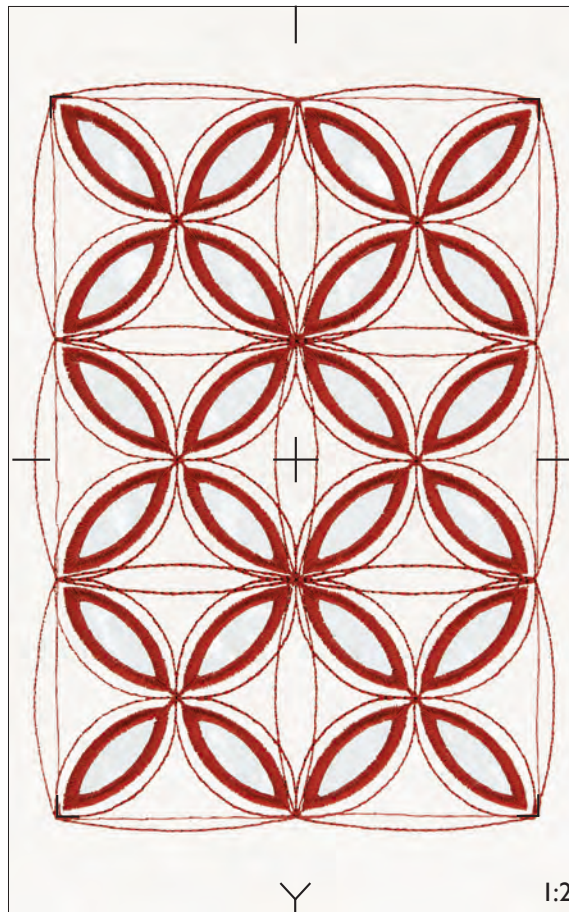











230 Easy Cutwork, design #10

Stitches: 31 304
 Height: 197 mm
 Width: 138 mm

230

- 1  1169
2225
- 2  1169
2225
- (✂)  Cut inside marked area
if not using INSPIRA™
Cutwork Needles
- 3  Needle #1
- 4  Needle #2
- *  Add a heavy weight water
soluble stabilizer
underneath the hoop
- 5  1169
2225
-  Trim and remove the
cut fabric
- 6  1169
2225
-  Clean the Bobbin Area



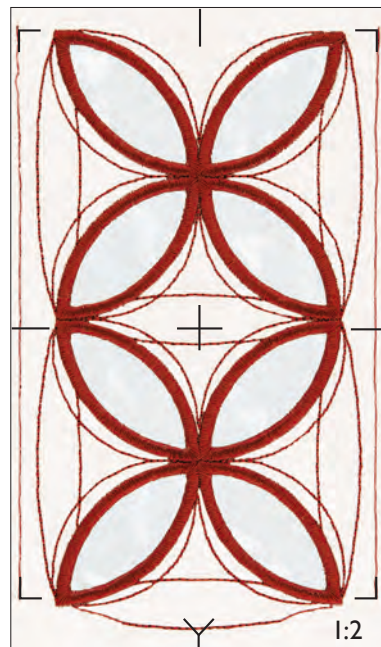
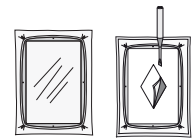





Gütermann Sulky
 Robison - Anton



230 Easy Cutwork, design #11

Stitches: 15 291
 Height: 160 mm
 Width: 95 mm

231

- 1  1169
2225
- (✂)  Cut inside marked area
if not using INSPIRA™
Cutwork Needles
- 2  Needle #1
- 3  Needle #2
- *  Add a heavy weight water
soluble stabilizer
underneath the hoop
- 4  1169
2225
-  Trim and remove the
cut fabric
- 5  1169
2225
-  Clean the Bobbin Area

Gütermann Sulky
 Robison - Anton

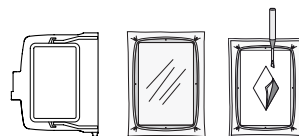

How to Embroider using the Texture Hoop:

Prepare your machine for embroidery. Choose the design you want to embroider. Trace/transfer the design to the template using a template marker.

Think about how you would like to embellish your design. What ribbons, yarns, fabric will be used? How will you place the embellishments to best fit the design?

- Hoop stabilizer and fabric (see “How to Hoop the Fabric”).
- Place the yarn and ribbons lengthwise and crosswise using the cuts in the inner hoop as guides (illustration A).

Note: the center of the hoop is marked and corresponds to the number 8 (both vertically and horizontally).

- When using yarn, let the yarn thread run through the cuts in the inner hoop. Place ribbons on top or between the cuts.
- Secure each ribbon/yarn with a clips (illustration B).

Illustration A

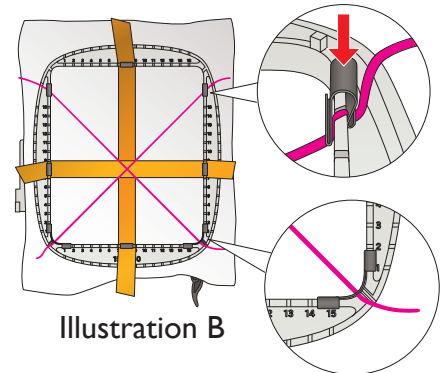

Place the template on top of the embellishments to see how they fit the design. Adjust the embellishment until you are satisfied (illustration C).

- Place a layer of water soluble stabilizer on top of the hooped fabric embellishment to prevent the presser foot from getting caught under the ribbons.
- Select one of the two basting designs (basting1 or basting2). Lower the machine speed and baste to secure all the ribbons to the bottom fabric. If you are using very thin yarn/ribbons use the double basting stitch (basting2).
- Select and embroider the design of your choice.
- When finished, remove the hoop from the embroidery unit. Carefully remove the clips using the “clip remover” (illustration D). Remove the basting stitch and water soluble stabilizer, trim the embellishment as you wish. (If you are using the design as a quilt block, leave the basting stitch to keep the ribbons in place until you have sewn the blocks together.)

Illustration B

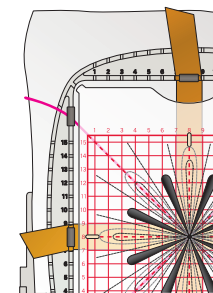

Illustration C

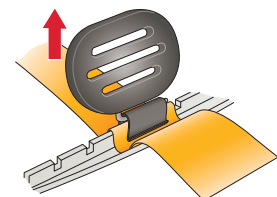
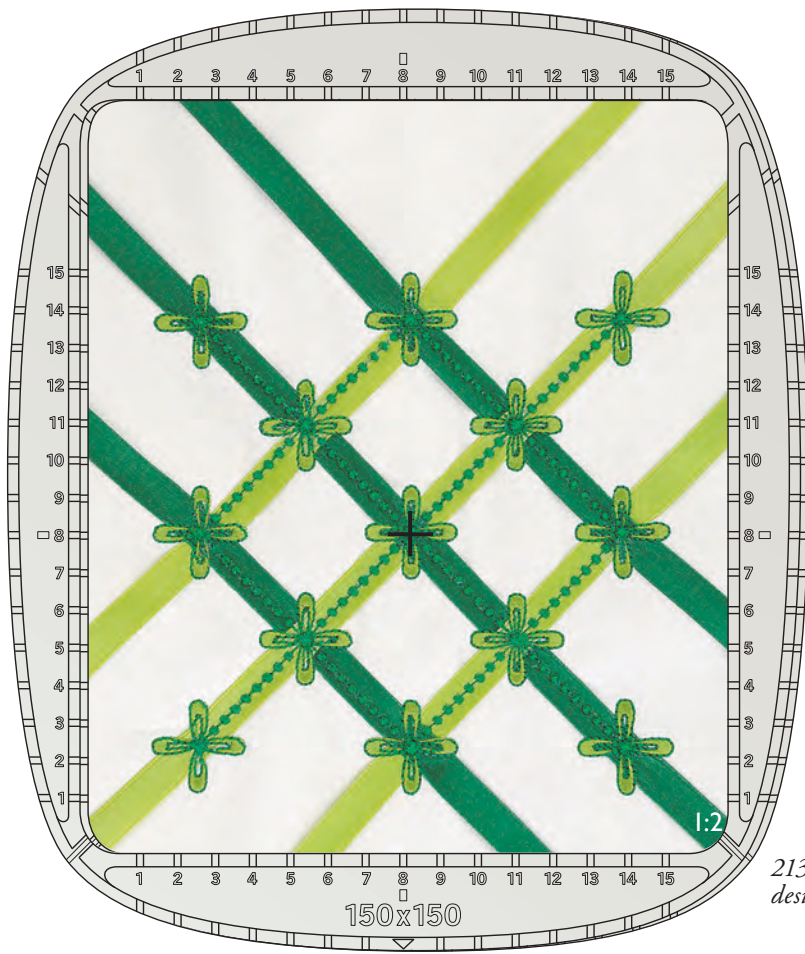

Illustration D



Stitches: 12 974
 Height: 142 mm
 Width: 141 mm



- 1 1332
2456
- 2 1718
1010

Gütermann Sulky
 Robison - Anton

213 Texture Hoop Ribbons & Flowers, design #6

Stitches: 13 404
 Height: 144 mm
 Width: 144 mm

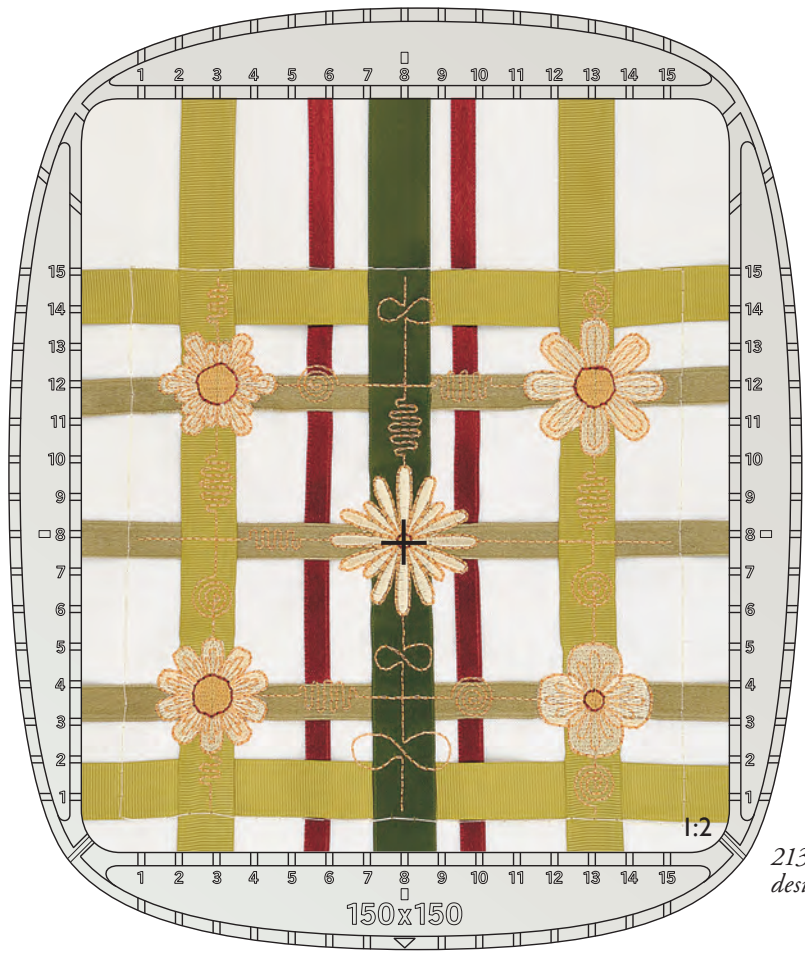

- 1 1067
2461
- 2 7007
1003
- 3 0622
2606
- 4 7055
1008

Gütermann Sulky
 Robison - Anton

213 Texture Hoop Ribbons & Flowers, design #13

Clarendon

30 mm 1.2 inch

A B a b 1 2

Kalligraphia

30 mm 1.2 inch

A B a b 1 2

Palace Script

30 mm 1.2 inch

A B a b 1 2

Mesa

30 mm 1.2 inch

A B C a b c 1 2 3

Clarendon

20 mm 0.8 inch

Aa12

Clarendon

12 mm 0.5 inch

A B C D E
a b c 1 2 3

Kalligraphia

20 mm 0.8 inch

Aa12

Kalligraphia

12 mm 0.5 inch

A B C D E
a b c 1 2 3

Palace Script

20 mm 0.8 inch

Aa12

Palace Script

12 mm 0.5 inch

A B C D E
a b c 1 2 3

0.8 inch

A b c 1 2 3

Mesa

12 mm 0.5 inch

A B C D E F
a b c d 1 2 3

Classic Collection

Sampler







Height: 344 mm Width: 75 mm



Height: 353 mm Width: 138 mm



Height: 345 mm Width: 57 mm

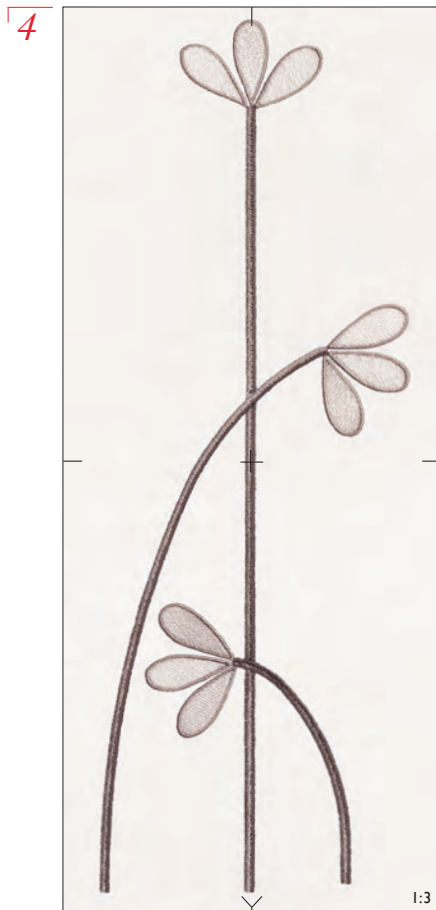

Height: 348 mm Width: 125 mm



Height: 346 mm Width: 115 mm



Height: 250 mm Width: 90 mm



Height: 230 mm Width: 130 mm



Height: 221 mm Width: 146 mm



Height: 233 mm Width: 72 mm



Height: 233 mm Width: 143 mm



Height: 236 mm Width: 146 mm



Height: 228 mm Width: 148 mm



Height: 230 mm Width: 73 mm



Height: 180 mm Width: 76 mm

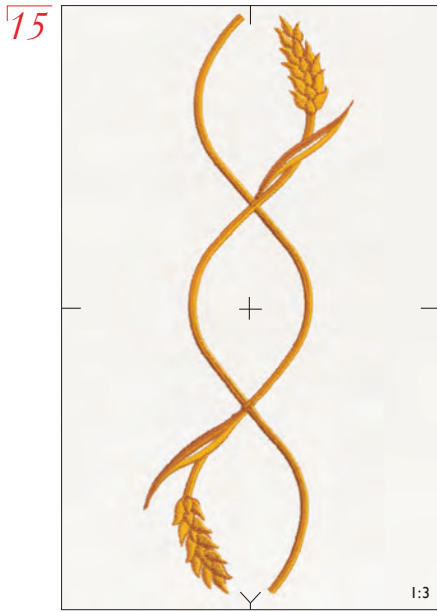

Height: 231 mm Width: 84 mm



Height: 230 mm Width: 125 mm



Height: 213 mm Width: 144 mm



Height: 232 mm Width: 127 mm

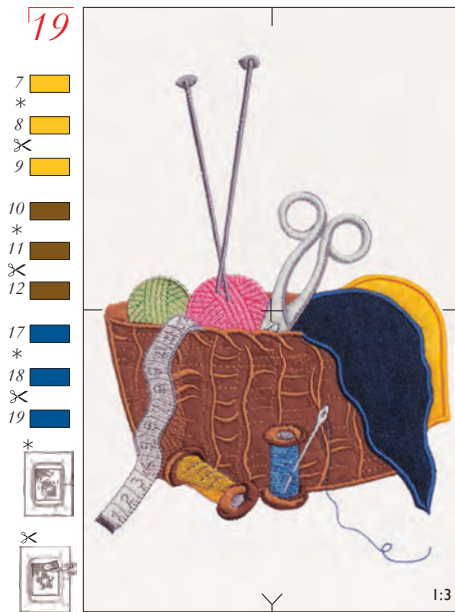

Height: 202 mm Width: 143 mm

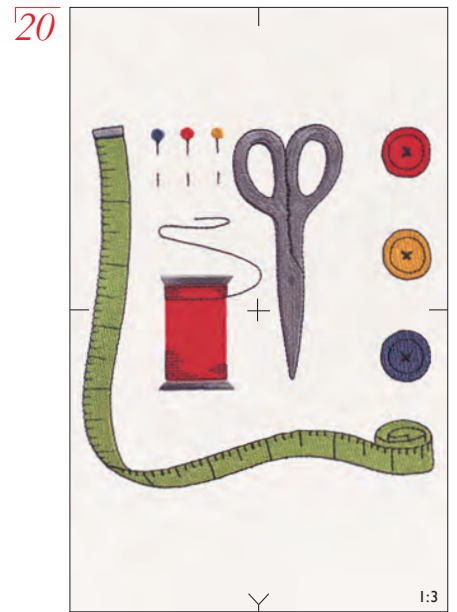

Height: 145 mm Width: 140 mm



Height: 137 mm Width: 137 mm



Height: 230 mm Width: 73 mm



Height: 145 mm Width: 145 mm



Height: 148 mm Width: 149 mm

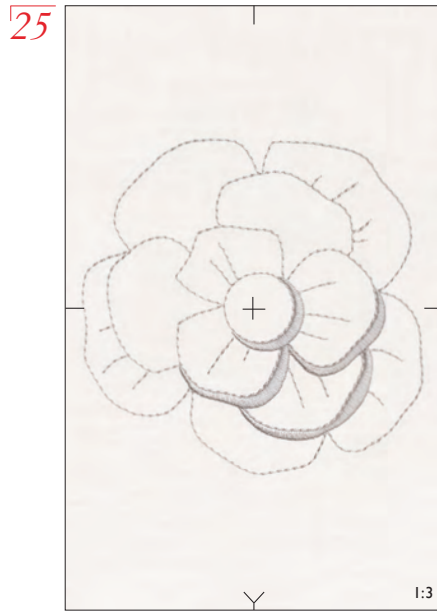

Height: 132 mm Width: 135 mm

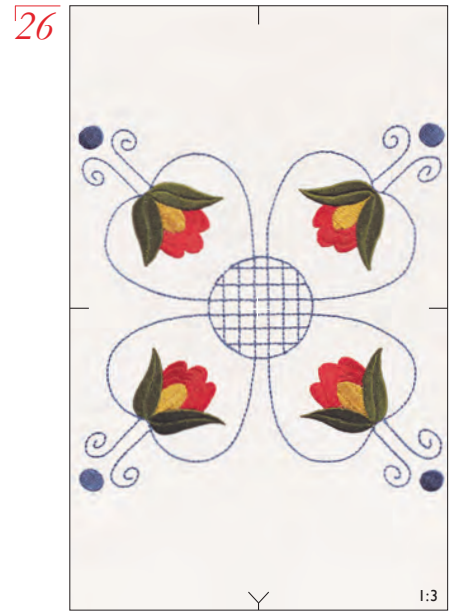

Height: 146 mm Width: 148 mm

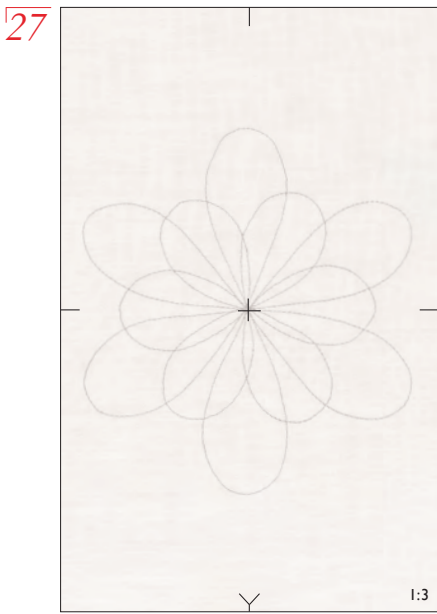

Height: 147 mm Width: 131 mm

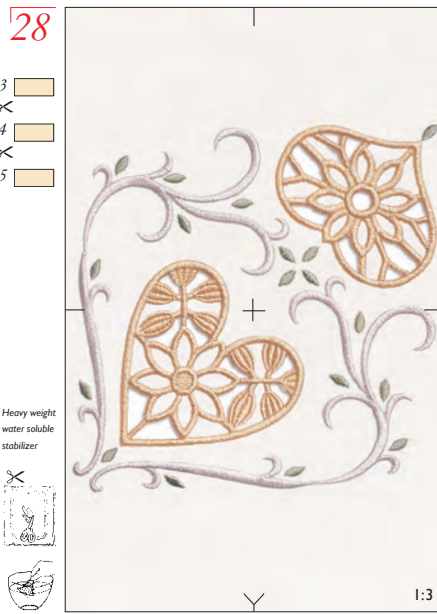

Height: 144 mm Width: 145 mm

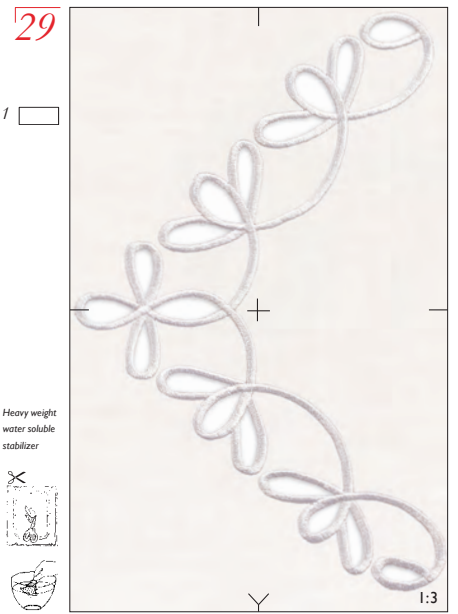

Height: 232 mm Width: 147 mm

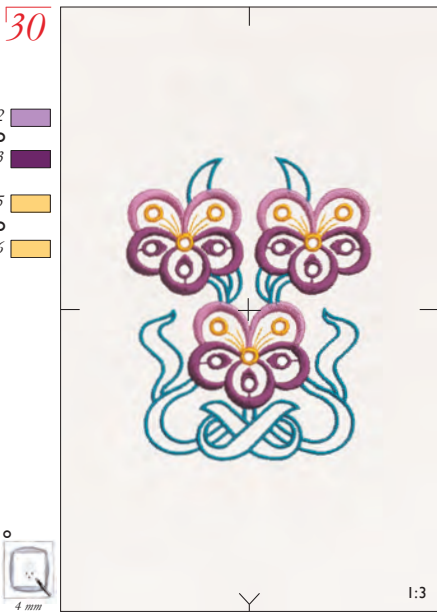

Height: 122 mm Width: 98 mm

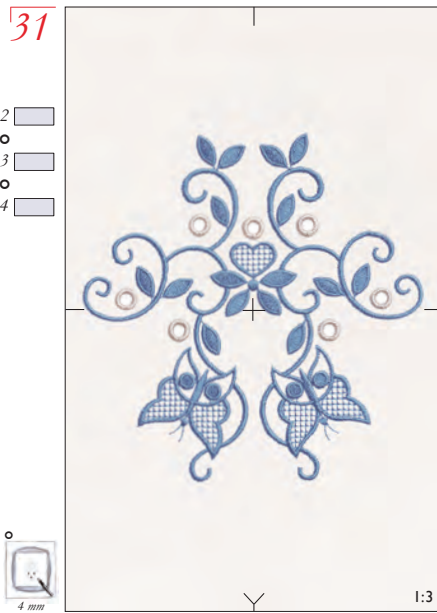

Height: 139 mm Width: 136 mm

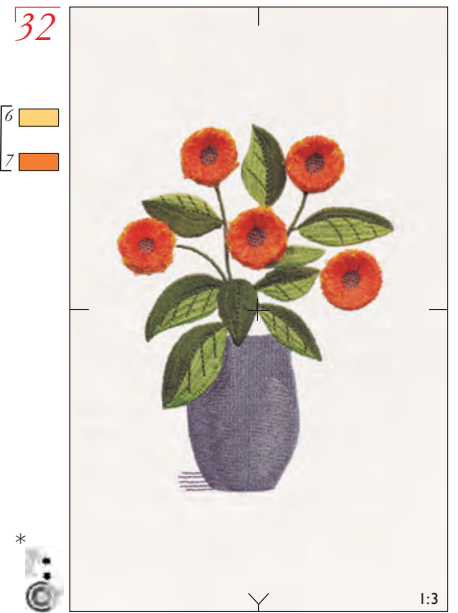

Height: 180 mm Width: 76 mm

33



Height: 122 mm Width: 83 mm

34



Height: 145 mm Width: 98 mm

35



Height: 120 mm Width: 68 mm

36



Height: 146 mm Width: 67 mm

37

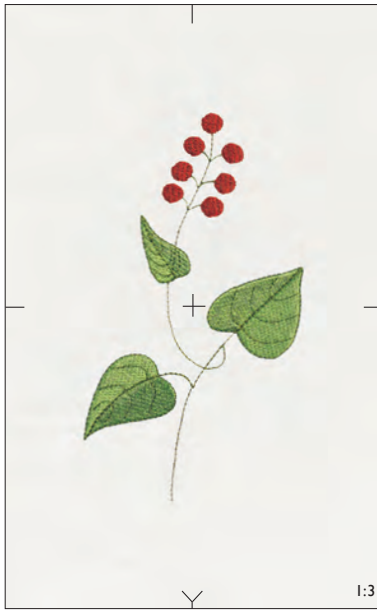

Height: 154 mm Width: 88 mm

38



Height: 145 mm Width: 148 mm

39



Height: 102mm Width: 138 mm

40

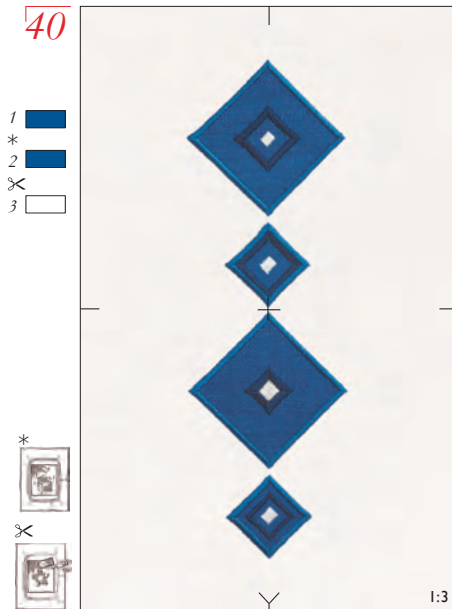

Height: 201 mm Width: 63 mm

41

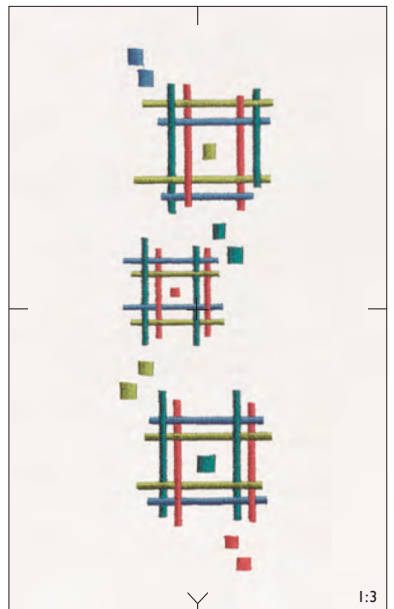

Height: 209 mm Width: 63 mm

42

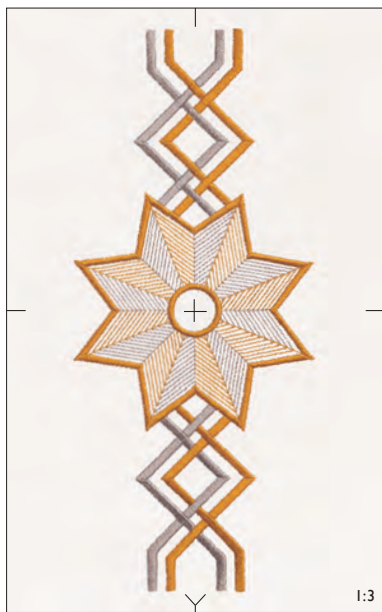

Height: 225 mm Width: 96 mm

43



Height: 164 mm Width: 72 mm

44



Height: 160 mm Width: 82 mm

45

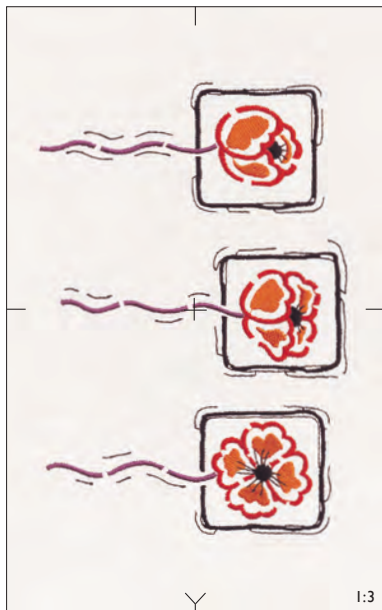

Height: 179 mm Width: 122 mm

46



Height: 144 mm Width: 145 mm

47

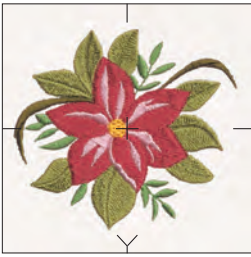

Height: 80 mm Width: 90 mm

48



Height: 93 mm Width: 69 mm

49

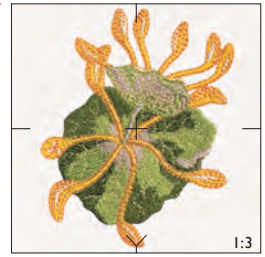

Height: 95 mm Width: 77 mm

50

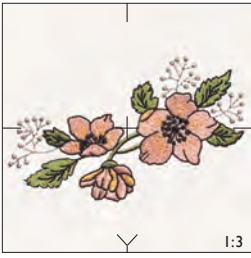

Height: 58 mm Width: 94 mm

51

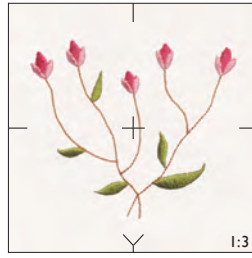

Height: 71 mm Width: 82 mm

52



Height: 75 mm Width: 87 mm

53

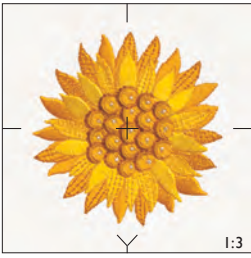

Height: 77 mm Width: 75 mm

54



Height: 65 mm Width: 65 mm

55

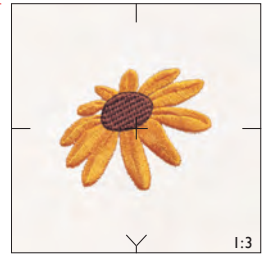

Height: 50 mm Width: 63 mm

56



Height: 64 mm Width: 91 mm

57

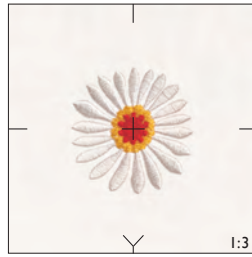

Height: 50 mm Width: 49 mm

58

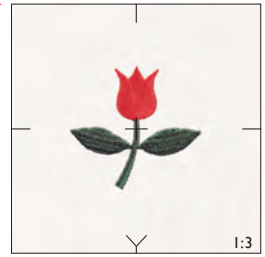

Height: 50 mm Width: 43 mm

59

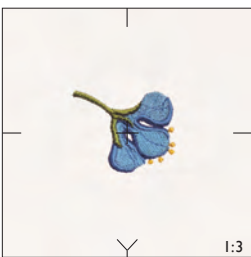

Height: 32 mm Width: 41 mm

60

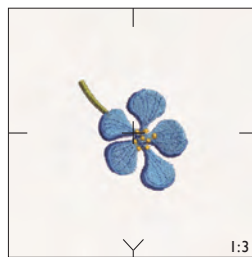

Height: 44 mm Width: 44 mm

61

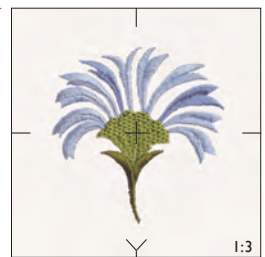

Height: 72 mm Width: 70 mm

62

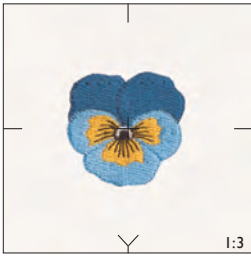

Height: 45 mm Width: 49 mm

63

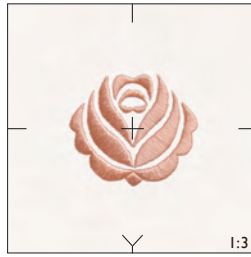

Height: 45 mm Width: 52 mm

64



Height: 70 mm Width: 69 mm

65

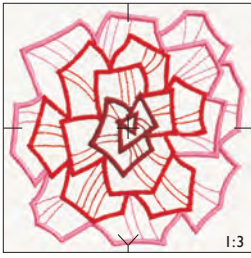

Height: 95 mm Width: 95 mm

66

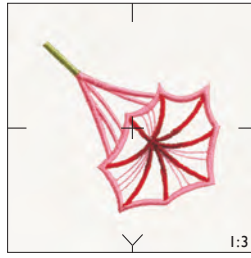

Height: 69 mm Width: 70 mm

67

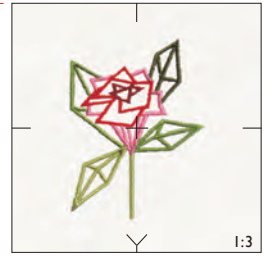

Height: 71 mm Width: 54 mm

68

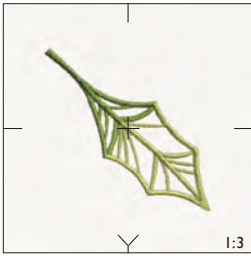

Height: 64 mm Width: 66 mm

69



Height: 51 mm Width: 53 mm

70



Height: 52 mm Width: 55 mm

71

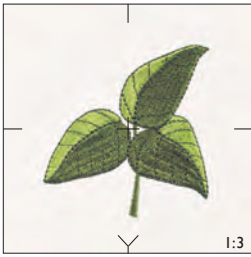

Height: 70 mm Width: 67 mm

72

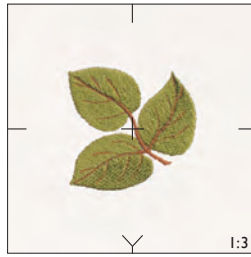

Height: 50 mm Width: 51 mm

73



Height: 50 mm Width: 47 mm

74

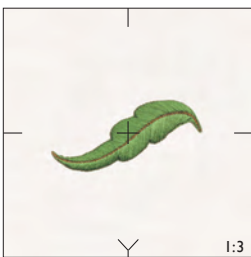

Height: 28 mm Width: 60 mm

75

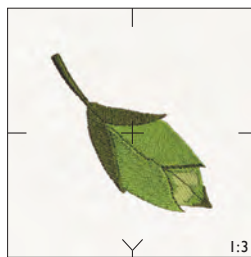

Height: 63 mm Width: 65 mm

76

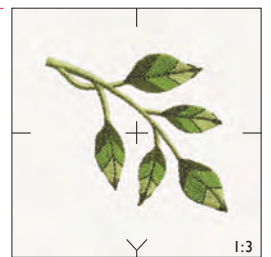

Height: 63 mm Width: 72 mm

77

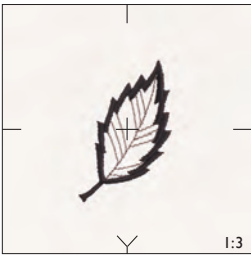

Height: 56 mm Width: 37 mm

78

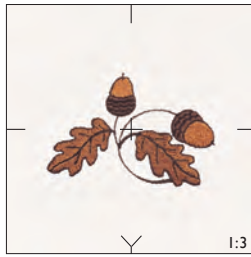

Height: 46 mm Width: 67 mm

79

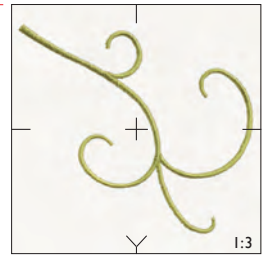

Height: 83 mm Width: 94 mm

80

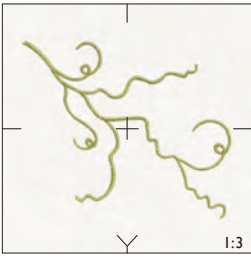

Height: 71 mm Width: 83 mm

81

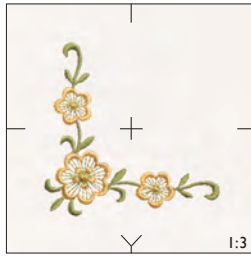

Height: 71 mm Width: 71 mm

82



Height: 73 mm Width: 85 mm

83

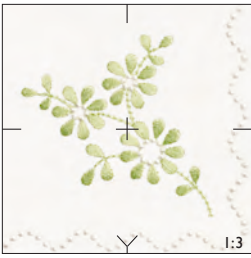

Height: 99 mm Width: 99 mm

84

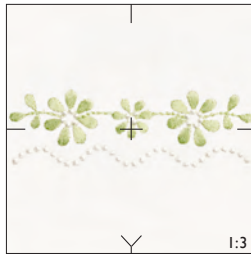

Height: 31 mm Width: 99 mm

85

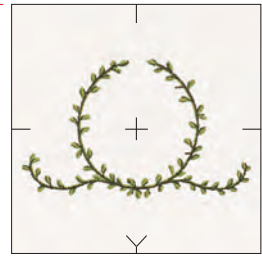

Height: 56 mm Width: 92 mm

86

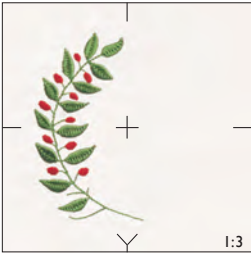

Height: 75 mm Width: 44 mm

87

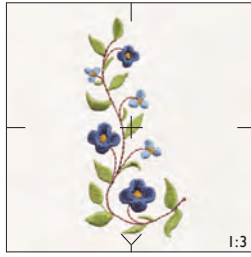

Height: 90 mm Width: 41 mm

88



Height: 49 mm Width: 49 mm

89



Height: 47 mm Width: 47 mm

90

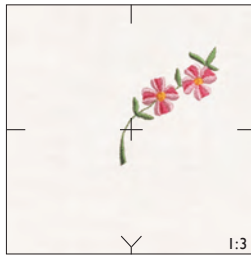

Height: 48 mm Width: 40 mm

91

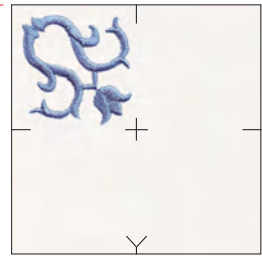

Height: 46 mm Width: 46 mm

92

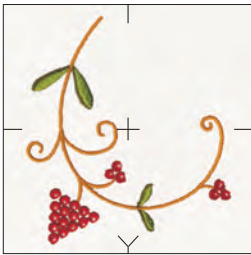

Height: 90 mm Width: 81 mm

93

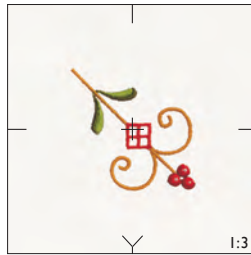

Height: 48 mm Width: 49 mm

94

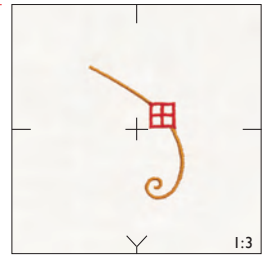

Height: 53 mm Width: 37 mm

95

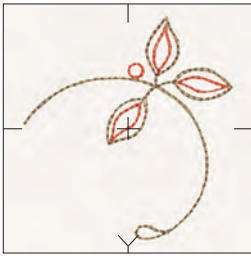

Height: 90 mm Width: 85 mm

96



Height: 51 mm Width: 41 mm

97

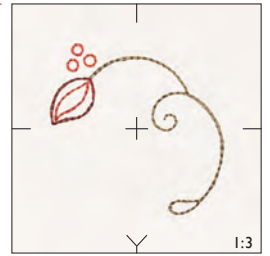

Height: 68 mm Width: 70 mm

98

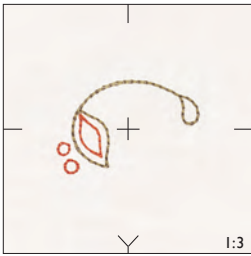

Height: 37 mm Width: 57 mm

99

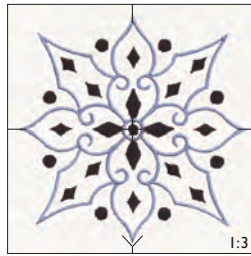

Height: 92 mm Width: 92 mm

100

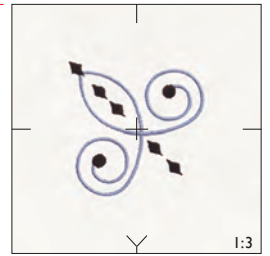

Height: 54 mm Width: 54 mm

101

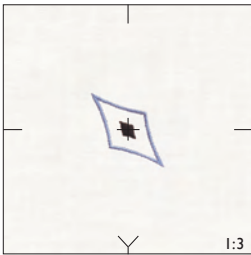

Height: 29 mm Width: 29 mm

102

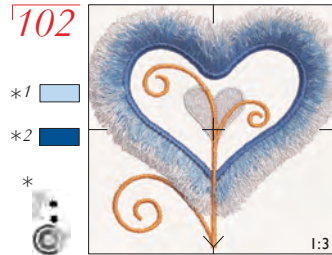

Height: 92 mm Width: 94 mm

103

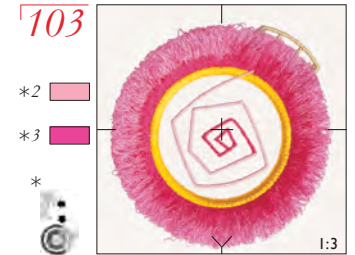

Height: 85 mm Width: 81 mm

104

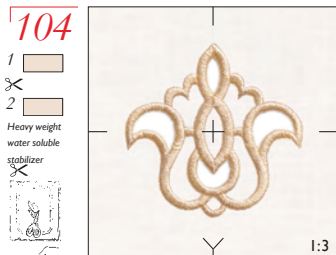

Height: 70 mm Width: 70 mm

105



Height: 42 mm Width: 45 mm

106

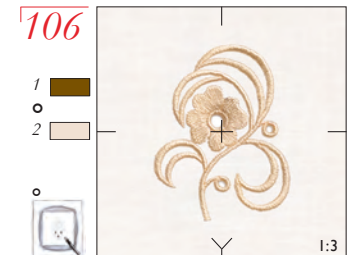

Height: 70 mm Width: 55 mm

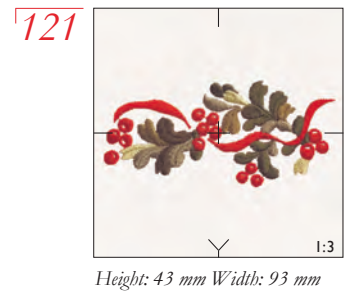
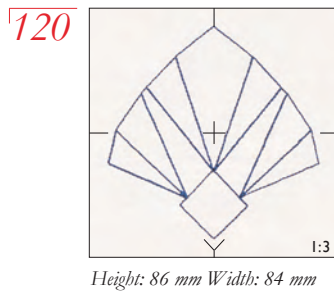
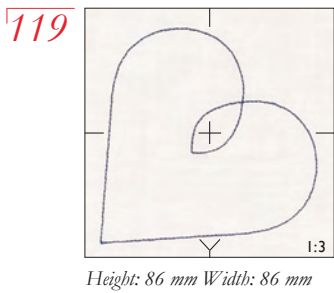
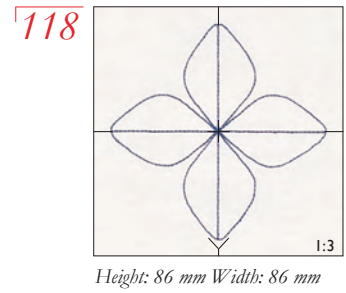
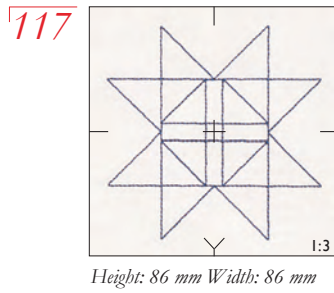
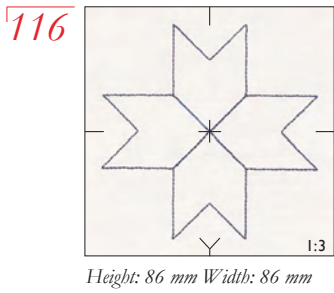
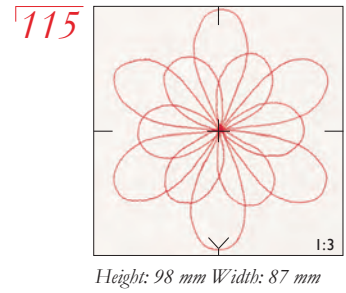
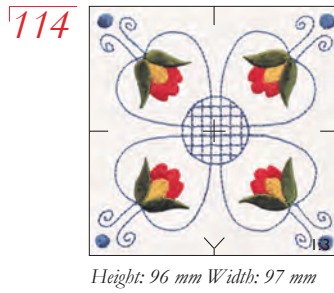
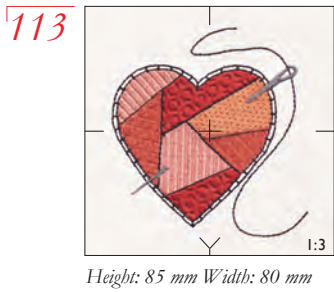
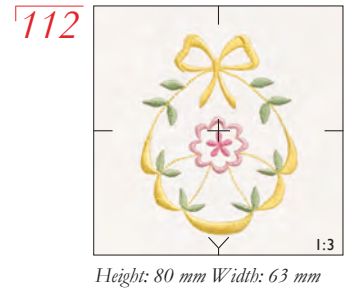
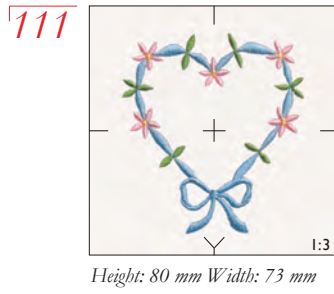
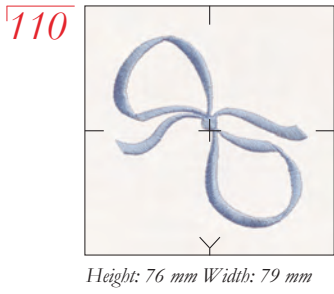
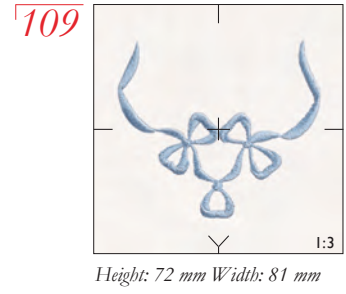
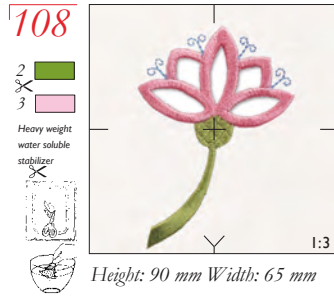
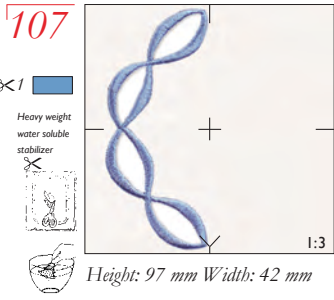

122

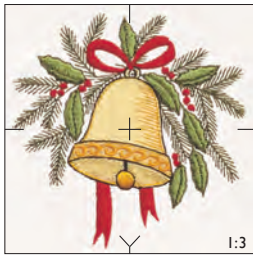

Height: 95 mm Width: 94 mm

123

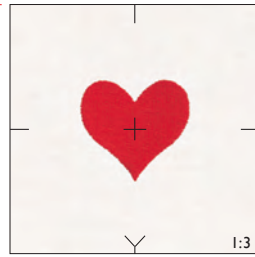

Height: 40 mm Width: 45 mm

124



Height: 221 mm Width: 137 mm

125



Height: 143 mm Width: 82 mm

126



Height: 140 mm Width: 78 mm

127



Height: 109 mm Width: 117 mm

128



Height: 148 mm Width: 146 mm

129



Height: 66 mm Width: 148 mm

130



Height: 195 mm Width: 124 mm

131



Height: 185 mm Width: 85 mm

132



Height: 235 mm Width: 123 mm

133



Height: 78 mm Width: 83 mm

134

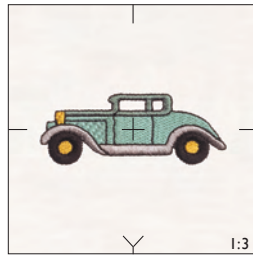

Height: 29 mm Width: 75 mm

135

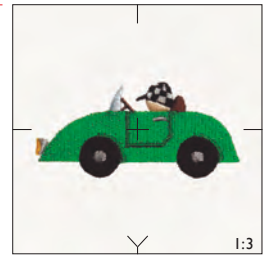

Height: 39 mm Width: 82 mm

136

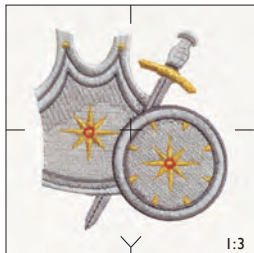

Height: 81 mm Width: 77 mm

137



Height: 81 mm Width: 79 mm

138



Height: 81 mm Width: 63 mm

139



Height: 50 mm Width: 63 mm

140

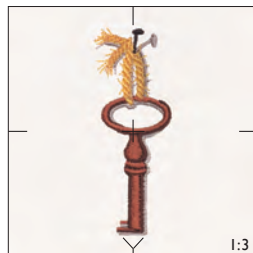

Height: 83 mm Width: 31 mm

141

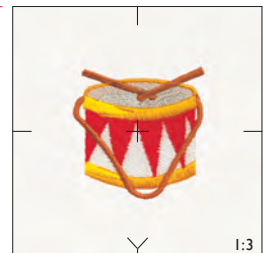

Height: 53 mm Width: 53 mm

142

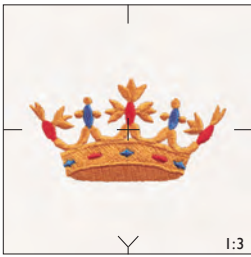

Height: 42 mm Width: 80 mm

143

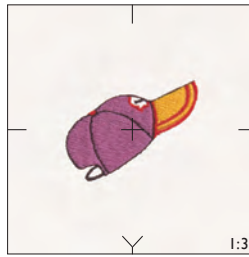

Height: 40 mm Width: 52 mm

144



Height: 59 mm Width: 70 mm

145

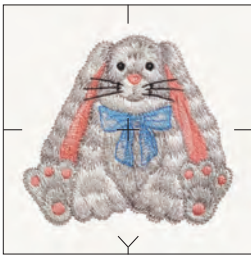

Height: 78 mm Width: 84 mm

146



Height: 56 mm Width: 64 mm

147

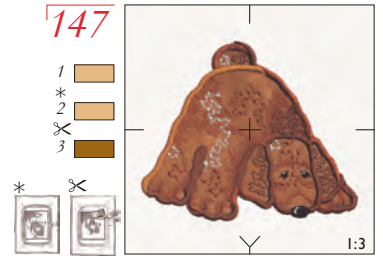

Height: 72 mm Width: 87 mm

148

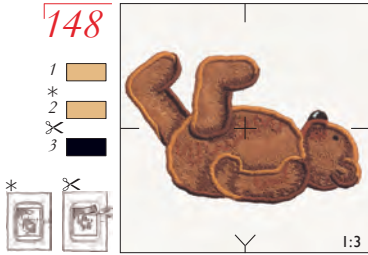

Height: 62 mm Width: 94 mm

149

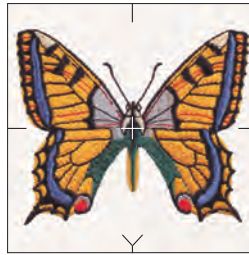

Height: 79 mm Width: 97 mm

150

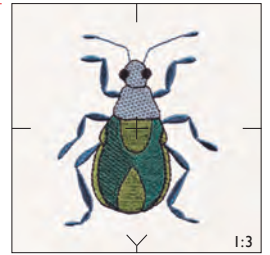

Height: 80 mm Width: 65 mm

151

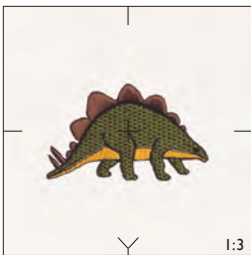

Height: 38 mm Width: 65 mm

152

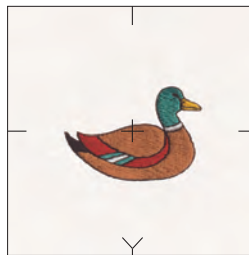

Height: 38 mm Width: 55 mm

153

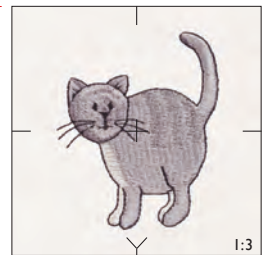

Height: 80 mm Width: 66 mm

154

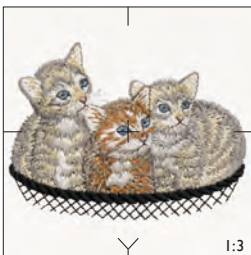

Height: 73 mm Width: 97 mm

155

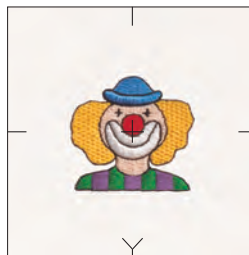

Height: 46 mm Width: 50 mm

156

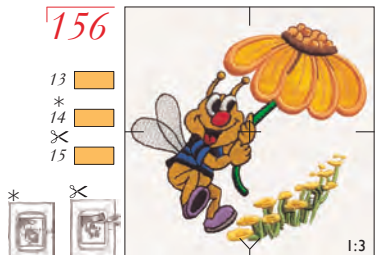

Height: 88 mm Width: 95 mm

157



Height: 80 mm Width: 45 mm

158



Height: 88 mm Width: 98 mm

159

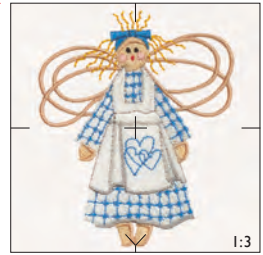

Height: 95 mm Width: 79 mm

160

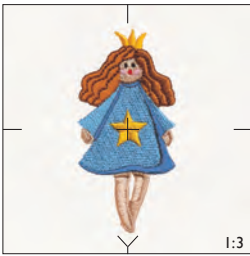

Height: 82 mm Width: 40 mm

161

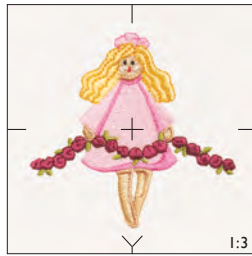

Height: 79 mm Width: 83 mm



162

*3

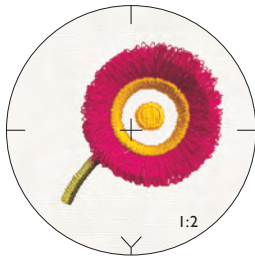

Height: 40 mm Width: 39 mm

163

*1

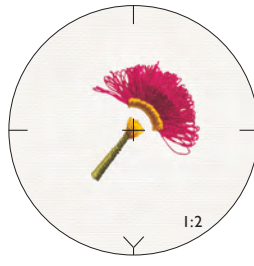

Height: 27 mm Width: 25 mm

164

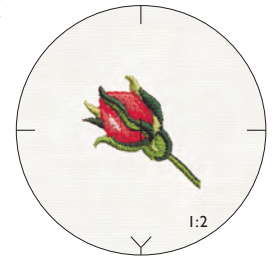

Height: 30 mm Width: 31 mm

165

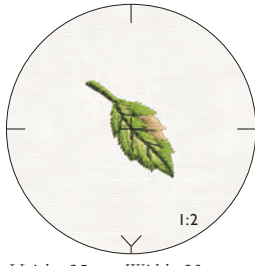

Height: 25 mm Width: 23 mm

166



Height: 35 mm Width: 28 mm

167

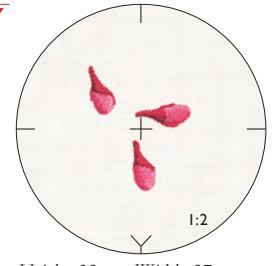

Height: 32 mm Width: 27 mm

168

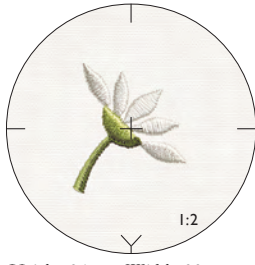

Height: 34 mm Width: 30 mm

169

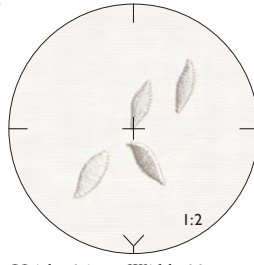

Height: 36 mm Width: 33 mm

170

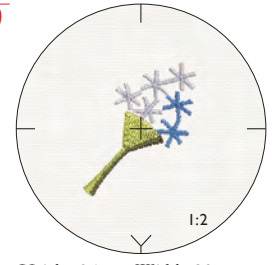

Height: 35 mm Width: 29 mm

171

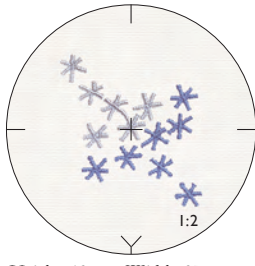

Height: 40 mm Width: 37 mm

172

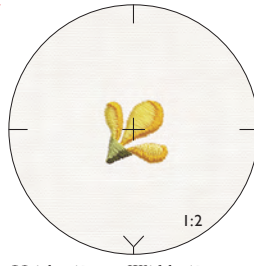

Height: 17 mm Width: 17 mm

173

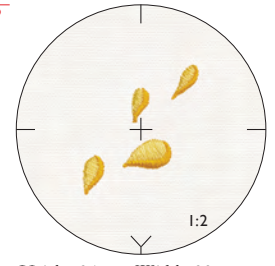

Height: 34 mm Width: 30 mm

174

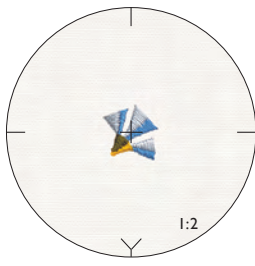

Height: 15 mm Width: 15 mm

175

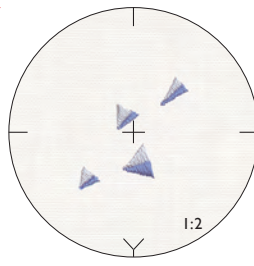

Height: 30 mm Width: 28 mm

